

2N3055(NPN), MJ2955(PNP)

Preferred Device

Complementary Silicon Power Transistors

Complementary silicon power transistors are designed for general-purpose switching and amplifier applications.

Features

- DC Current Gain – $h_{FE} = 20-70 @ I_C = 4 \text{ A dc}$
- Collector–Emitter Saturation Voltage –
 $V_{CE(sat)} = 1.1 \text{ Vdc (Max) @ } I_C = 4 \text{ A dc}$
- Excellent Safe Operating Area
- Pb–Free Packages are Available*

MAXIMUM RATINGS

Rating	Symbol	Value	Unit
Collector–Emitter Voltage	V_{CEO}	60	Vdc
Collector–Emitter Voltage	V_{CER}	70	Vdc
Collector–Base Voltage	V_{CB}	100	Vdc
Emitter–Base Voltage	V_{EB}	7	Vdc
Collector Current – Continuous	I_C	15	A dc
Base Current	I_B	7	A dc
Total Power Dissipation @ $T_C = 25^\circ\text{C}$ Derate Above 25°C	P_D	115 0.657	W W/ $^\circ\text{C}$
Operating and Storage Junction Temperature Range	T_J, T_{stg}	–65 to +200	$^\circ\text{C}$

Maximum ratings are those values beyond which device damage can occur. Maximum ratings applied to the device are individual stress limit values (not normal operating conditions) and are not valid simultaneously. If these limits are exceeded, device functional operation is not implied, damage may occur and reliability may be affected.

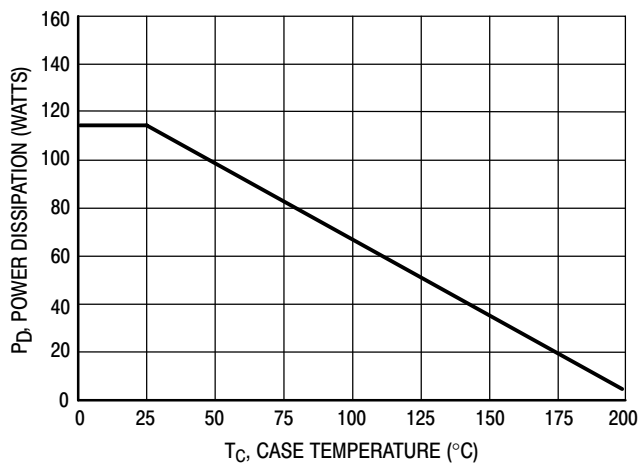

Figure 1. Power Derating

*For additional information on our Pb–Free strategy and soldering details, please download the ON Semiconductor Soldering and Mounting Techniques Reference Manual, SOLDERRM/D.



ON Semiconductor®

<http://onsemi.com>

15 AMPERE POWER TRANSISTORS COMPLEMENTARY SILICON 60 VOLTS, 115 WATTS

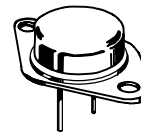

TO-204AA (TO-3)
CASE 1-07
STYLE 1

MARKING DIAGRAM



xxxx55 = Device Code
xxxx = 2N30 or MJ20
G = Pb–Free Package
A = Location Code
YY = Year
WW = Work Week
MEX = Country of Origin

ORDERING INFORMATION

Device	Package	Shipping
2N3055	TO–204AA	100 Units / Tray
2N3055G	TO–204AA (Pb–Free)	100 Units / Tray
MJ2955	TO–204AA	100 Units / Tray
MJ2955G	TO–204AA (Pb–Free)	100 Units / Tray

Preferred devices are recommended choices for future use and best overall value.

2N3055(NPN), MJ2955(PNP)

Thermal Characteristics

Characteristic	Symbol	Max	Unit
Thermal Resistance, Junction-to-Case	$R_{\theta JC}$	1.52	$^{\circ}\text{C/W}$

Electrical Characteristics ($T_C = 25^{\circ}\text{C}$ unless otherwise noted)

Characteristic	Symbol	Min	Max	Unit
----------------	--------	-----	-----	------

OFF CHARACTERISTICS*

Collector-Emitter Sustaining Voltage (Note 1) ($I_C = 200\text{ mA dc}$, $I_B = 0$)	$V_{CEO(sus)}$	60	–	Vdc
Collector-Emitter Sustaining Voltage (Note 1) ($I_C = 200\text{ mA dc}$, $R_{BE} = 100\ \Omega$)	$V_{CER(sus)}$	70	–	Vdc
Collector Cutoff Current ($V_{CE} = 30\text{ Vdc}$, $I_B = 0$)	I_{CEO}	–	0.7	mAdc
Collector Cutoff Current ($V_{CE} = 100\text{ Vdc}$, $V_{BE(off)} = 1.5\text{ Vdc}$) ($V_{CE} = 100\text{ Vdc}$, $V_{BE(off)} = 1.5\text{ Vdc}$, $T_C = 150^{\circ}\text{C}$)	I_{CEX}	–	1.0 5.0	mAdc
Emitter Cutoff Current ($V_{BE} = 7.0\text{ Vdc}$, $I_C = 0$)	I_{EBO}	–	5.0	mAdc

ON CHARACTERISTICS* (Note 1)

DC Current Gain ($I_C = 4.0\text{ Adc}$, $V_{CE} = 4.0\text{ Vdc}$) ($I_C = 10\text{ Adc}$, $V_{CE} = 4.0\text{ Vdc}$)	h_{FE}	20 5.0	70 –	–
Collector-Emitter Saturation Voltage ($I_C = 4.0\text{ Adc}$, $I_B = 400\text{ mA dc}$) ($I_C = 10\text{ Adc}$, $I_B = 3.3\text{ Adc}$)	$V_{CE(sat)}$	–	1.1 3.0	Vdc
Base-Emitter On Voltage ($I_C = 4.0\text{ Adc}$, $V_{CE} = 4.0\text{ Vdc}$)	$V_{BE(on)}$	–	1.5	Vdc

SECOND BREAKDOWN

Second Breakdown Collector Current with Base Forward Biased ($V_{CE} = 40\text{ Vdc}$, $t = 1.0\text{ s}$, Nonrepetitive)	$I_{s/b}$	2.87	–	Adc
---	-----------	------	---	-----

DYNAMIC CHARACTERISTICS

Current Gain – Bandwidth Product ($I_C = 0.5\text{ Adc}$, $V_{CE} = 10\text{ Vdc}$, $f = 1.0\text{ MHz}$)	f_T	2.5	–	MHz
*Small-Signal Current Gain ($I_C = 1.0\text{ Adc}$, $V_{CE} = 4.0\text{ Vdc}$, $f = 1.0\text{ kHz}$)	h_{fe}	15	120	–
*Small-Signal Current Gain Cutoff Frequency ($V_{CE} = 4.0\text{ Vdc}$, $I_C = 1.0\text{ Adc}$, $f = 1.0\text{ kHz}$)	f_{hfe}	10	–	kHz

*Indicates Within JEDEC Registration. (2N3055)

1. Pulse Test: Pulse Width $\leq 300\ \mu\text{s}$, Duty Cycle $\leq 2.0\%$.

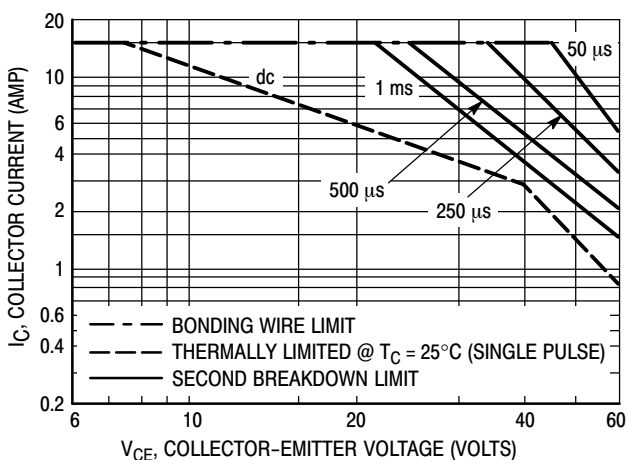

Figure 2. Active Region Safe Operating Area

There are two limitations on the power handling ability of a transistor: average junction temperature and second breakdown. Safe operating area curves indicate $I_C - V_{CE}$ limits of the transistor that must be observed for reliable operation; i.e., the transistor must not be subjected to greater dissipation than the curves indicate.

The data of Figure 2 is based on $T_C = 25^{\circ}\text{C}$; $T_{J(pk)}$ is variable depending on power level. Second breakdown pulse limits are valid for duty cycles to 10% but must be derated for temperature according to Figure 1.

2N3055(NPN), MJ2955(PNP)

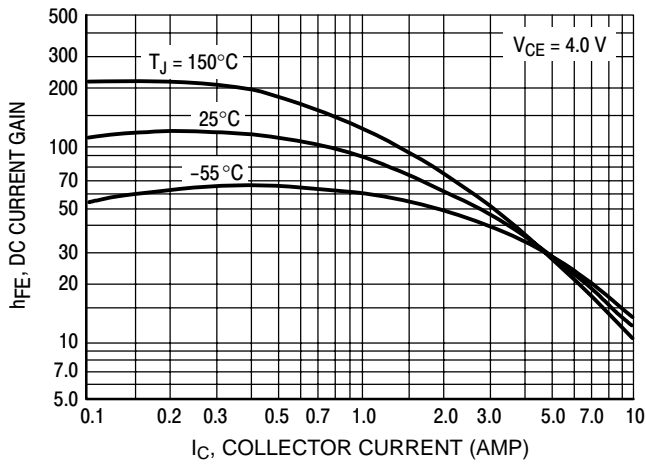

Figure 3. DC Current Gain, 2N3055 (NPN)

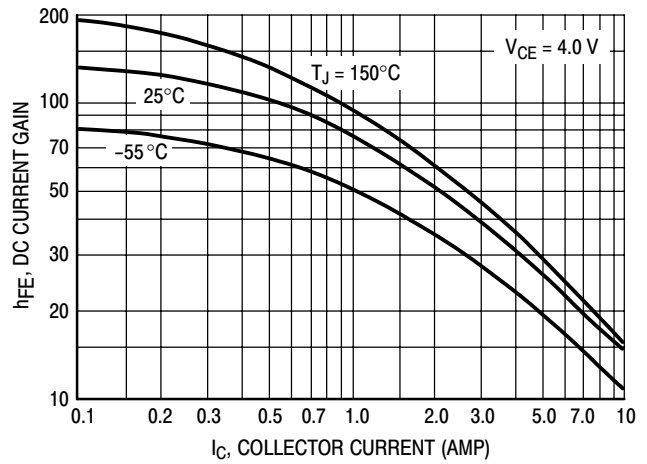

Figure 4. DC Current Gain, MJ2955 (PNP)

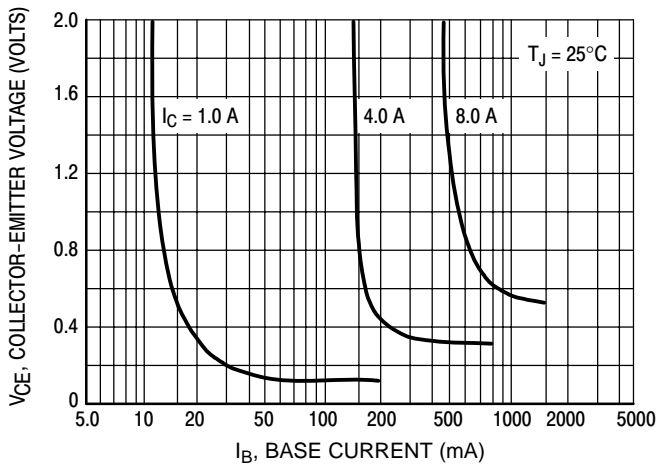

Figure 5. Collector Saturation Region, 2N3055 (NPN)

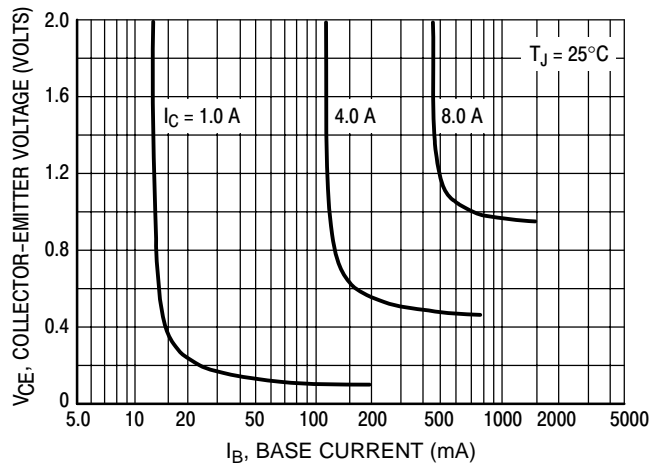

Figure 6. Collector Saturation Region, MJ2955 (PNP)

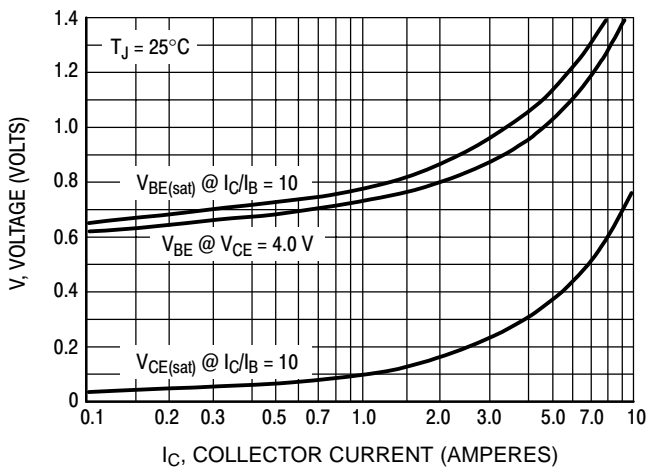

Figure 7. "On" Voltages, 2N3055 (NPN)

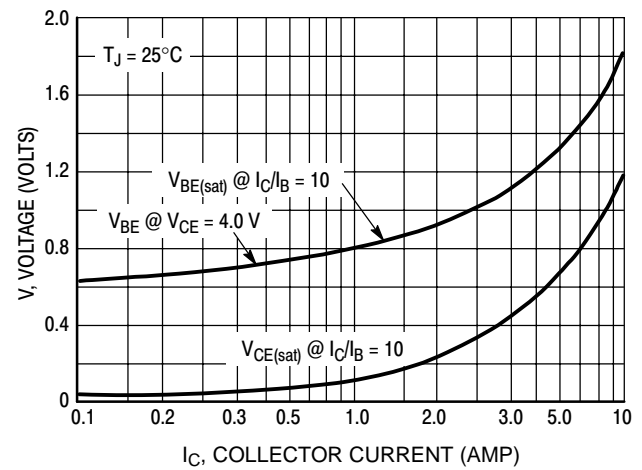

Figure 8. "On" Voltages, MJ2955 (PNP)

MECHANICAL CASE OUTLINE PACKAGE DIMENSIONS



TO-204 (TO-3) CASE 1-07 ISSUE Z

DATE 05/18/1988



SCALE 1:1



- NOTES:
1. DIMENSIONING AND TOLERANCING PER ANSI Y14.5M, 1982.
 2. CONTROLLING DIMENSION: INCH.
 3. ALL RULES AND NOTES ASSOCIATED WITH REFERENCED TO-204AA OUTLINE SHALL APPLY.

DIM	INCHES		MILLIMETERS	
	MIN	MAX	MIN	MAX
A	1.550 REF	---	39.37 REF	---
B	---	1.050	---	26.67
C	0.250	0.335	6.35	8.51
D	0.038	0.043	0.97	1.09
E	0.055	0.070	1.40	1.77
G	0.430 BSC	---	10.92 BSC	---
H	0.215 BSC	---	5.46 BSC	---
K	0.440	0.480	11.18	12.19
L	---	0.665 BSC	---	16.89 BSC
N	---	0.830	---	21.08
Q	0.151	0.165	3.84	4.19
U	1.187 BSC	---	30.15 BSC	---
V	0.131	0.188	3.33	4.77

- | | | | | |
|--|--|---|---|---|
| <p>STYLE 1:
PIN 1. BASE
2. EMITTER
CASE: COLLECTOR</p> | <p>STYLE 2:
PIN 1. BASE
2. COLLECTOR
CASE: EMITTER</p> | <p>STYLE 3:
PIN 1. GATE
2. SOURCE
CASE: DRAIN</p> | <p>STYLE 4:
PIN 1. GROUND
2. INPUT
CASE: OUTPUT</p> | <p>STYLE 5:
PIN 1. CATHODE
2. EXTERNAL TRIP/DELAY
CASE: ANODE</p> |
| <p>STYLE 6:
PIN 1. GATE
2. EMITTER
CASE: COLLECTOR</p> | <p>STYLE 7:
PIN 1. ANODE
2. OPEN
CASE: CATHODE</p> | <p>STYLE 8:
PIN 1. CATHODE #1
2. CATHODE #2
CASE: ANODE</p> | <p>STYLE 9:
PIN 1. ANODE #1
2. ANODE #2
CASE: CATHODE</p> | |

ON Semiconductor and are trademarks of Semiconductor Components Industries, LLC (SCILLC). SCILLC reserves the right to make changes without further notice to any products herein. SCILLC makes no warranty, representation or guarantee regarding the suitability of its products for any particular purpose, nor does SCILLC assume any liability arising out of the application or use of any product or circuit, and specifically disclaims any and all liability, including without limitation special, consequential or incidental damages. "Typical" parameters which may be provided in SCILLC data sheets and/or specifications can and do vary in different applications and actual performance may vary over time. All operating parameters, including "Typicals" must be validated for each customer application by customer's technical experts. SCILLC does not convey any license under its patent rights nor the rights of others. SCILLC products are not designed, intended, or authorized for use as components in systems intended for surgical implant into the body, or other applications intended to support or sustain life, or for any other application in which the failure of the SCILLC product could create a situation where personal injury or death may occur. Should Buyer purchase or use SCILLC products for any such unintended or unauthorized application, Buyer shall indemnify and hold SCILLC and its officers, employees, subsidiaries, affiliates, and distributors harmless against all claims, costs, damages, and expenses, and reasonable attorney fees arising out of, directly or indirectly, any claim of personal injury or death associated with such unintended or unauthorized use, even if such claim alleges that SCILLC was negligent regarding the design or manufacture of the part. SCILLC is an Equal Opportunity/Affirmative Action Employer.

onsemi, **Onsemi**, and other names, marks, and brands are registered and/or common law trademarks of Semiconductor Components Industries, LLC dba "**onsemi**" or its affiliates and/or subsidiaries in the United States and/or other countries. **onsemi** owns the rights to a number of patents, trademarks, copyrights, trade secrets, and other intellectual property. A listing of **onsemi**'s product/patent coverage may be accessed at www.onsemi.com/site/pdf/Patent-Marking.pdf. **onsemi** reserves the right to make changes at any time to any products or information herein, without notice. The information herein is provided "as-is" and **onsemi** makes no warranty, representation or guarantee regarding the accuracy of the information, product features, availability, functionality, or suitability of its products for any particular purpose, nor does **onsemi** assume any liability arising out of the application or use of any product or circuit, and specifically disclaims any and all liability, including without limitation special, consequential or incidental damages. Buyer is responsible for its products and applications using **onsemi** products, including compliance with all laws, regulations and safety requirements or standards, regardless of any support or applications information provided by **onsemi**. "Typical" parameters which may be provided in **onsemi** data sheets and/or specifications can and do vary in different applications and actual performance may vary over time. All operating parameters, including "Typicals" must be validated for each customer application by customer's technical experts. **onsemi** does not convey any license under any of its intellectual property rights nor the rights of others. **onsemi** products are not designed, intended, or authorized for use as a critical component in life support systems or any FDA Class 3 medical devices or medical devices with a same or similar classification in a foreign jurisdiction or any devices intended for implantation in the human body. Should Buyer purchase or use **onsemi** products for any such unintended or unauthorized application, Buyer shall indemnify and hold **onsemi** and its officers, employees, subsidiaries, affiliates, and distributors harmless against all claims, costs, damages, and expenses, and reasonable attorney fees arising out of, directly or indirectly, any claim of personal injury or death associated with such unintended or unauthorized use, even if such claim alleges that **onsemi** was negligent regarding the design or manufacture of the part. **onsemi** is an Equal Opportunity/Affirmative Action Employer. This literature is subject to all applicable copyright laws and is not for resale in any manner.

ADDITIONAL INFORMATION

TECHNICAL PUBLICATIONS:

Technical Library: www.onsemi.com/design/resources/technical-documentation
onsemi Website: www.onsemi.com

ONLINE SUPPORT: www.onsemi.com/support

For additional information, please contact your local Sales Representative at www.onsemi.com/support/sales