

1/4-Inch 5Mp CMOS Digital Image Sensor

AR0543

General Description

The onsemi AR0543 is a 1/4-inch CMOS active-pixel digital image sensor with a pixel array of 2592 H x 1944 V (2608 H x 1960 V including border pixels). It incorporates sophisticated on-chip camera functions such as windowing, mirroring, column and row skip modes, and snapshot mode. It is programmable through a simple two-wire serial interface and has very low power consumption.

Table 1. KEY PERFORMANCE PARAMETERS

Parameter		Typical Value
Optical Format		1/4-inch (4:3)
Active Imager Size		3.63 mm (H) x 2.72 (V) : 4.54 mm diagonal
Active Pixels		2592 H x 1944 V
Pixel Size		1.4 μm x 1.4 μm
Chief Ray Angle		25.0°
Color Filter Array		RGB Bayer pattern
Shutter Type		Electronic rolling shutter (ERS)
Input clock frequency		6 – 27 MHz
Maximum Data Rate	MIPI	840 Mbps per lane
Frame Rate	Full Resolution (2592 x 1944)	15 fps
	1080P	19.8 fps (100% FOV, crop to 16:9) 30 fps (77% FOV, crop to 16:9)
	720P	30 fps (98% FOV, crop to 16:9, bin2) 60 fps (98% FOV, crop to 16:9, skip2)
	VGA (640x480)	60 fps (100% FOV, bin2skip2) 115 fps (100% FOV, skip4)
ADC Resolution		10-bit, on-die
Responsivity		0.82 V/lux-sec (550 nm)
Dynamic Range		66 dB
SNR _{MAX}		36.5 dB
Supply Voltage	Digital I/O	1.7 – 1.9 V (1.8 V nominal) or 2.4 – 3.1 V (2.8 V nominal)
Supply Voltage	Digital Core	1.15 – 1.25 (1.2 V nominal)
	Analog	2.6 – 3.1V (2.8 V nominal)
	Digital 1.8V	1.7 – 1.9 V (1.8 V nominal)
Power Consumption	Full Resolution	MIPI: 215 mW at 70°C (TYP)
	Standby	25 μW at 70°C (TYP)
Package		Bare die 5.256 x 5.065 mm 45-pin CSP
Operating Temperature		–30°C to +70°C (at junction)

Features

- Low Dark Current
- Simple Two-wire Serial Interface
- Auto Black Level Calibration
- Support for External LED or Xenon Flash
- High Frame Rate Preview Mode with Arbitrary Down-size Scaling from Maximum Resolution
- Programmable Controls: Gain, Horizontal and Vertical Blanking, Auto Black Level Offset Correction, Frame Size/Rate, Exposure, Left-right and Top-bottom Image Reversal, Window Size, and Panning
- Data Interfaces: Single/Dual Lanes Serial Mobile Industry Processor Interface (MIPI)
- On-die Phase-locked Loop (PLL) Oscillator
- Bayer Pattern Down-size Scaler
- Superior Low-light Performance
- 4Kb One-time Programmable Memory (OTPM) for Storing Shading Correction Coefficients and Module Information
- Integrated Position and Color-based Shading Correction
- Extended Flash Duration that is Up to Start of Frame Readout

Applications

- Cellular Phones
- Digital Still Cameras
- PDAs
- Tablets

Table 2. ORDERING INFORMATION

Part Number	Product Description	Orderable Product Attribute Description
AR0543CSCS25SMKA0-CR	5 MP 1/4" CIS HB	Chip Tray without Protective Film

GENERAL DESCRIPTION

The AR0543 digital image sensor features onsemi's breakthrough low-noise CMOS imaging technology that achieves near-CCD image quality (based on signal-to-noise ratio and low-light sensitivity) while maintaining the inherent size, cost, and integration advantages of CMOS.

The AR0543 sensor can generate full resolution image at up to 15 frames per second (fps). An on-chip analog-to-digital converter (ADC) generates a 10-bit value for each pixel.

FUNCTIONAL OVERVIEW

The AR0543 is a progressive-scan sensor that generates a stream of pixel data at a constant frame rate. It uses an on-chip, phase-locked loop (PLL) to generate all internal clocks from a single master input clock running between 6 and 27 MHz. The maximum pixel rate is 84 Mp/s, corresponding to a pixel clock rate of 84 MHz. A block diagram of the sensor is shown in Figure 1.

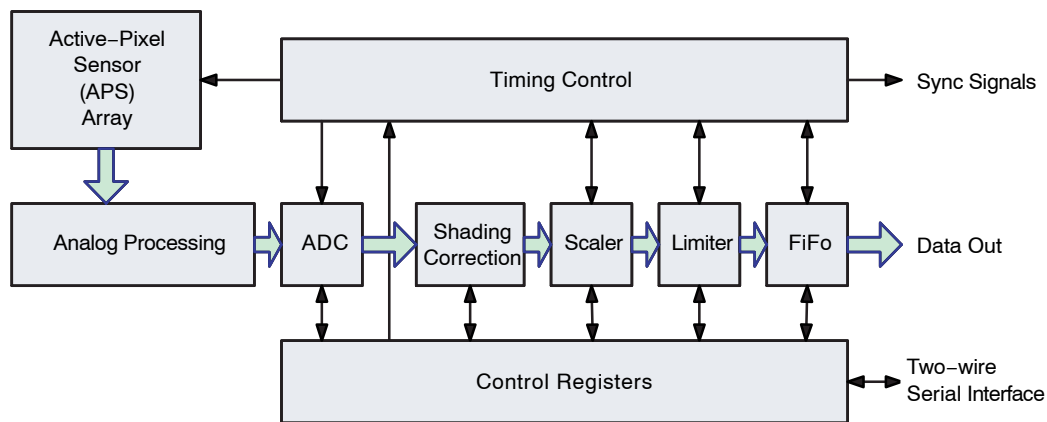

Figure 1. Block Diagram

The core of the sensor is a 5 Mp active-pixel array. The timing and control circuitry sequences through the rows of the array, resetting and then reading each row in turn. In the time interval between resetting a row and reading that row, the pixels in the row integrate incident light. The exposure is controlled by varying the time interval between reset and readout. Once a row has been read, the data from the columns are sequenced through an analog signal chain (providing offset correction and gain), and then through an ADC. The output from the ADC is a 10-bit value for each pixel in the array. The ADC output passes through a digital processing signal chain (which provides further data path corrections and applies digital gain).

The pixel array contains optically active and light-shielded ("dark") pixels. The dark pixels are used to provide data for on-chip offset-correction algorithms ("black level" control).

The sensor contains a set of control and status registers that can be used to control many aspects of the sensor behavior including the frame size, exposure, and gain setting.

These registers can be accessed through a two-wire serial interface.

Pixel Array

The output from the sensor is a Bayer pattern; alternate rows are a sequence of either green and red pixels or blue and green pixels. The offset and gain stages of the analog signal chain provide per-color control of the pixel data.

The control registers, timing and control, and digital processing functions shown in Figure 1 on page 2 are partitioned into three logical parts:

- A sensor core that provides array control and data path corrections. The output of the sensor core is a 10-bit pixel data stream qualified by an output data clock.
- A digital shading correction block to compensate for color/brightness shading introduced by the lens or chief ray angle (CRA) curve mismatch.
- Additional functionality is provided. This includes a horizontal and vertical image scaler, a limiter, a data compressor, an output FIFO, and a serializer.

The output FIFO is present to prevent data bursts by keeping the data rate continuous. Programmable slew rates are also available to reduce the effect of electromagnetic interference from the output interface.

AR0543

A flash output signal is provided to allow an external xenon or LED light source to synchronize with the sensor exposure time.

The sensor core uses a Bayer color pattern, as shown in Figure 2. The even-numbered rows contain green and red

pixels; odd-numbered rows contain blue and green pixels. Even-numbered columns contain green and blue pixels; odd-numbered columns contain red and green pixels.

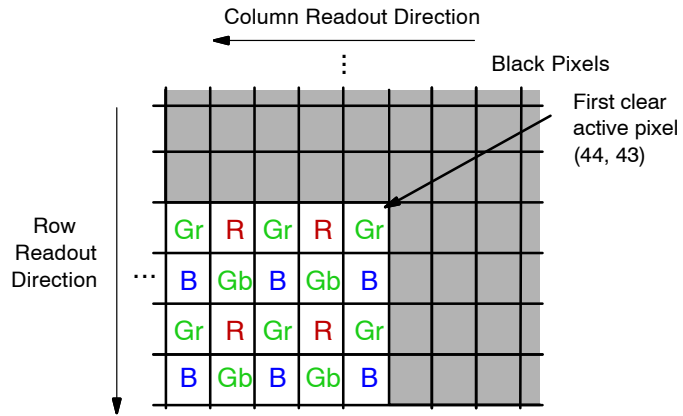

Figure 2. Pixel Color Pattern Detail (Top Right Corner)

OPERATING MODES

By default, the AR0543 powers up with the serial pixel data interface enabled. The sensor can operate in serial MIPI mode. This mode is preconfigured at the factory. In either case, the sensor has a SMIA-compatible register interface while the two-wire serial device address is compliant with SMIA or MIPI requirements as appropriate. The reset level on the TEST pin must be tied in a way that is compatible with the configured serial interface of the sensor, for instance, TEST = 1 for MIPI.

Typical configurations are shown in Figure 3 on page 4. These operating modes are described in “[Control of the Signal Interface](#)” on page 11.

For low-noise operation, the AR0543 requires separate power supplies for analog and digital. Incoming digital and analog ground conductors can be tied together next to the die. Both power supply rails should be decoupled from the ground using capacitors as close as possible to the die.

Caution: onsemi does not recommend the use of inductance filters on the power supplies or output signals.

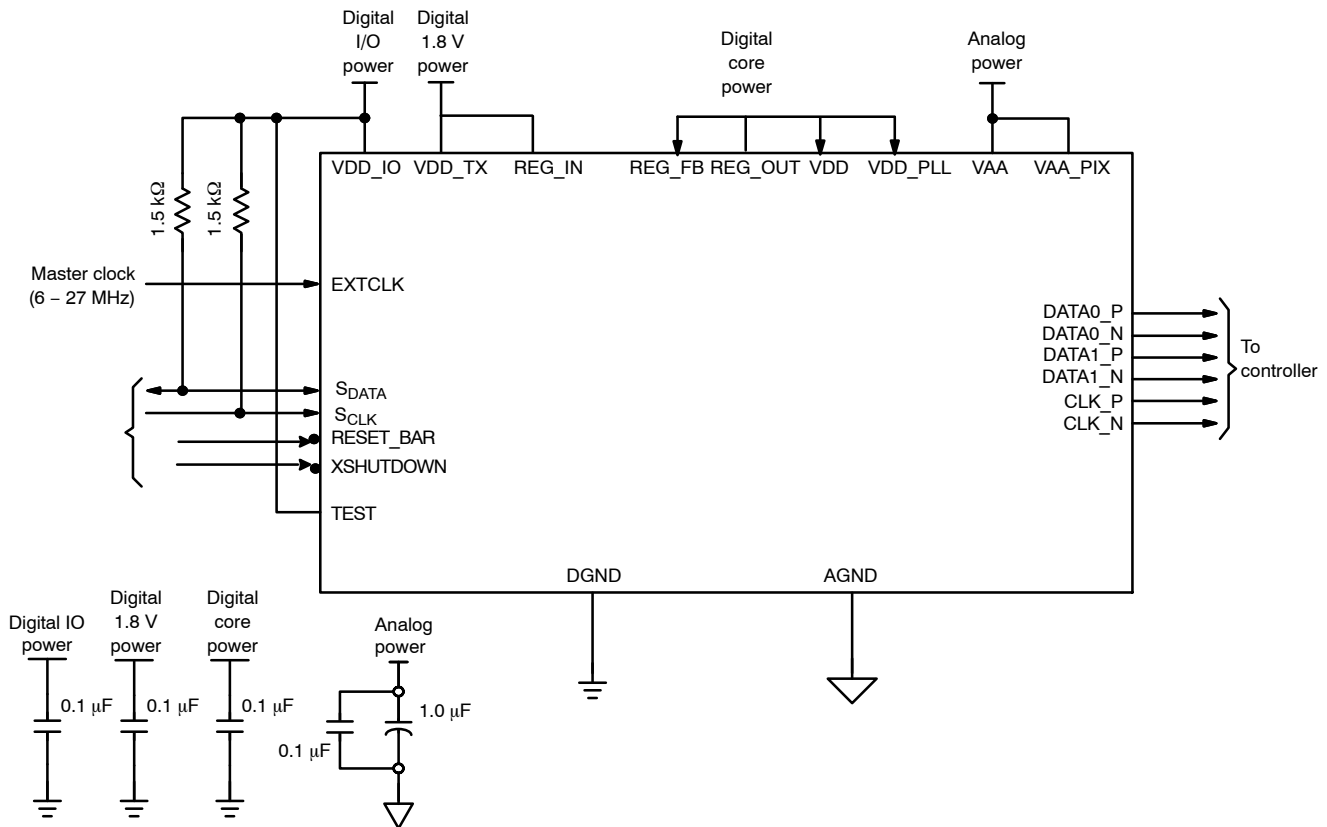

NOTE:

- All power supplies must be adequately decoupled.
- onsemi recommends a resistor value of 1.5 kΩ, but a greater value may be used for slower two-wire speed. This pull-up resistor is not required if the controller drives a valid logic level on S_{CLK} at all times.
- V_{DD_IO} can be either 1.8 V (nominal) or 2.8 V (nominal). If V_{DD_IO} is 1.8 V, V_{DD_IO} can be tied to Digital 1.8 V Power.
- V_{AA} and V_{AA_PIX} must be tied together.
- V_{DD} and V_{DD_PLL} must be tied together
- onsemi recommends having 0.1 μF and 1.0 μF decoupling capacitors for analog power supply and 0.1 μF decoupling capacitor for other power supplies. Actual values and results may vary depending on layout and design considerations.
- TEST must be tied to V_{DD_IO} for MIPI configuration (Device ID address = 0x6C).
- V_{DD_TX} and REG_IN must be tied together.
- Refer to the power-up sequence for XSHUTDOWN and RESET_BAR control.
- The frequency range for EXTCLK must be 6 – 27 MHz.
- The GPI[3:0] pins, which can be either statically pulled HIGH/LOW to be used as module IDs, or they can be programmed to perform special functions (TRIGGER, OE_BAR, S_ADDR, STANDBY) to be dynamically controlled, are not shown in Figure 3.
- The FLASH, which can be used for flash control, is not shown in Figure 3.

Figure 3. Typical Configuration: Serial Dual-Lane MIPI Pixel Data Interface

AR0543

SIGNAL DESCRIPTIONS

Table 3 provides signal descriptions for AR0543 die. For pad location and aperture information, refer to the AR0543 die data sheet. The CSP package only supports MIPI signals.

Table 3. SIGNAL DESCRIPTIONS

Pad Name	Pad Type	Description
EXTCLK	Input	Master clock input, 6 – 27 MHz.
RESET_BAR	Input	Asynchronous active LOW reset. When asserted, data output stops and all internal registers are restored to their factory default settings.
XSHUTDOWN	Input	Asynchronous active LOW reset. When asserted, data output stops and all internal registers are restored to their factory default settings. This pin will turn off the digital power domain and is the lowest power state of the sensor.
S_CLK	Input	Serial clock for access to control and status registers.
GPI[3:0]	Input	General purpose inputs. After reset, these pads are powered-down by default; this means that it is not necessary to bond to these pads. Any of these pads can be configured to provide hardware control of the standby, output enable, SADDR select, and shutter trigger functions. onsemi recommends that unused GPI pins be tied to DGND, but can also be left floating.
TEST	Input	Enable manufacturing test modes. Connect to V _{DD_IO} power for the MIPI-configured sensor.
S_DATA	I/O	Serial data from reads and writes to control and status registers.
REG_OUT	I/O	1.2 V on-chip regulator output node.
REG_IN	I/O	On-chip regulator input node. It needs to be connected to external 1.8 V.
REG_FB	I/O	This pad is receiving the 1.2 V feedback from REG_OUT. It needs to be connected to REG_OUT.
LINE_VALID	Output	LINE_VALID (LV) output. Qualified by PIXCLK.
FRAME_VALID	Output	FRAME_VALID (FV) output. Qualified by PIXCLK.
D _{OUT} [9:0]	Output	Parallel pixel data output. Qualified by PIXCLK.
PIXCLK	Output	Pixel clock. Used to qualify the LV, FV, and D _{OUT} [9:0] outputs.
FLASH	Output	Flash output. Synchronization pulse for external light source. Can be left floating if not used.
V _{PP}	Supply	Power supply used to program one-time programmable (OTP) memory.
V _{DD_TX}	Supply	Digital PHY power supply. Digital power supply for the serial interface.
V _{AA}	Supply	Analog power supply.
V _{AA_PIX}	Supply	Analog power supply for the pixel array.
A _{GND}	Supply	Analog ground.
V _{DD}	Supply	Digital core power supply.
V _{DD_IO}	Supply	I/O power supply.
D _{GND}	Supply	Common ground for digital and I/O.
V _{DD_PLL}	Supply	PLL power supply.

Table 4. CSP (MIPI) PACKAGE PINOUT

	1	2	3	4	5	6	7	8
A	D _{GND}	DATA1_P	DATA0_P	CLK_P	D _{GND}	RESET_BAR	GPI2	D _{GND}
B	D _{GND}	DATA1_N	DATA0_N	CLK_N	EXTCLK	V _{DD}	D _{GND}	V _{DD}
C	V _{DD}	V _{DD_TX}	-	-	-	-	D _{GND}	V _{DD_IO}
D	REG_OUT	REG_IN0	-	-	-	-	NC	A _{GND}
E	D _{GND}	V _{DD}	-	-	-	NC	GPI1	V _{AA}
F	S _{CLK}	D _{GND}	S _{DATA}	V _{DD_IO}	TEST	A _{GND}	GPI0	V _{AA}
G	REG_IN1	REG_IN1	XSHUTDOWN	V _{PP}	V _{AA_PIX}	A _{GND}	A _{GND}	V _{AA}

1. NC = Do not connect. For manufacturing test purpose only.

OUTPUT DATA FORMAT

Pixel Data Interface

AR0543 image data is read out in a progressive scan. Valid image data is surrounded by horizontal blanking and vertical blanking, as shown in Figure 4. The amount of horizontal blanking and vertical blanking is programmable.

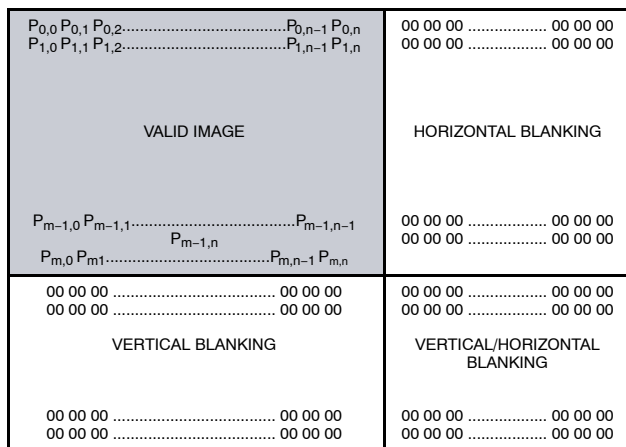

Figure 4. Spatial Illustration of Image Readout

TWO-WIRE SERIAL REGISTER INTERFACE

The two-wire serial interface bus enables read/write access to control and status registers within the AR0543. The interface protocol uses a master/slave model in which a master controls one or more slave devices. The sensor acts as a slave device. The master generates a clock (S_{CLK}) that is an input to the sensor and is used to synchronize transfers. Data is transferred between the master and the slave on a bidirectional signal (S_{DATA}). S_{DATA} is pulled up to V_{DD_IO} off-chip by a 1.5 kΩ resistor. Either the slave or master device can drive S_{DATA} LOW – the interface protocol determines which device is allowed to drive S_{DATA} at any given time.

The protocols described in the two-wire serial interface specification allow the slave device to drive S_{CLK} LOW; the AR0543 uses S_{CLK} as an input only and therefore never drives it LOW.

Protocol

Data transfers on the two-wire serial interface bus are performed by a sequence of low-level protocol elements:

1. a (repeated) start condition
2. a slave address/data direction byte
3. an (a no) acknowledge bit
4. a message byte
5. a stop condition

The bus is idle when both S_{CLK} and S_{DATA} are HIGH. Control of the bus is initiated with a start condition, and the bus is released with a stop condition. Only the master can generate the start and stop conditions.

Start Condition

A start condition is defined as a HIGH-to-LOW transition on S_{DATA} while S_{CLK} is HIGH. At the end of a transfer, the master can generate a start condition without previously generating a stop condition; this is known as a “repeated start” or “restart” condition.

Stop Condition

A stop condition is defined as a LOW-to-HIGH transition on S_{DATA} while S_{CLK} is HIGH.

Data Transfer

Data is transferred serially, 8 bits at a time, with the MSB transmitted first. Each byte of data is followed by an acknowledge bit or a no-acknowledge bit. This data transfer mechanism is used for the slave address/data direction byte and for message bytes.

One data bit is transferred during each S_{CLK} clock period. S_{DATA} can change when S_{CLK} is LOW and must be stable while S_{CLK} is HIGH.

Slave Address/Data Direction Byte

Bits [7:1] of this byte represent the device slave address and bit [0] indicates the data transfer direction. A “0” in bit [0] indicates a WRITE, and a “1” indicates a READ. The default slave addresses used by the AR0543 for the MIPI configured sensor are 0x6C (write address) and 0x6D (read address) in accordance with the MIPI specification. Alternate slave addresses of 0x6E (write address) and 0x6F (read address) can be selected by enabling and asserting the S_{ADDR} signal through the GPI pad.

An alternate slave address can also be programmed through R0x31FC.

Message Byte

Message bytes are used for sending register addresses and register write data to the slave device and for retrieving register read data.

Acknowledge Bit

Each 8-bit data transfer is followed by an acknowledge bit or a no-acknowledge bit in the S_{CLK} clock period following the data transfer. The transmitter (which is the master when writing, or the slave when reading) releases S_{DATA}. The receiver indicates an acknowledge bit by driving S_{DATA} LOW. As for data transfers, S_{DATA} can change when S_{CLK} is LOW and must be stable while S_{CLK} is HIGH.

No-Acknowledge Bit

The no-acknowledge bit is generated when the receiver does not drive S_{DATA} LOW during the S_{CLK} clock period following a data transfer. A no-acknowledge bit is used to terminate a read sequence.

Typical Sequence

A typical READ or WRITE sequence begins by the master generating a start condition on the bus. After the start condition, the master sends the 8-bit slave address/data

direction byte. The last bit indicates whether the request is for a read or a write, where a “0” indicates a write and a “1” indicates a read. If the address matches the address of the slave device, the slave device acknowledges receipt of the address by generating an acknowledge bit on the bus.

If the request was a WRITE, the master then transfers the 16-bit register address to which the WRITE should take place. This transfer takes place as two 8-bit sequences and the slave sends an acknowledge bit after each sequence to indicate that the byte has been received. The master then transfers the data as an 8-bit sequence; the slave sends an acknowledge bit at the end of the sequence. The master stops writing by generating a (re)start or stop condition.

If the request was a READ, the master sends the 8-bit write slave address/data direction byte and 16-bit register address, the same way as with a WRITE request. The master then generates a (re)start condition and the 8-bit read slave address/data direction byte, and clocks out the register data, eight bits at a time. The master generates an acknowledge bit after each 8-bit transfer. The slave’s internal register address is automatically incremented after every 8 bits are transferred. The data transfer is stopped when the master sends a no-acknowledge bit.

Single READ from Random Location

This sequence (Figure 5 on page 7) starts with a dummy WRITE to the 16-bit address that is to be used for the READ. The master terminates the WRITE by generating a restart condition. The master then sends the 8-bit read slave address/data direction byte and clocks out one byte of register data. The master terminates the READ by generating a no-acknowledge bit followed by a stop condition. Figure 5 shows how the internal register address maintained by the AR0543 is loaded and incremented as the sequence proceeds.

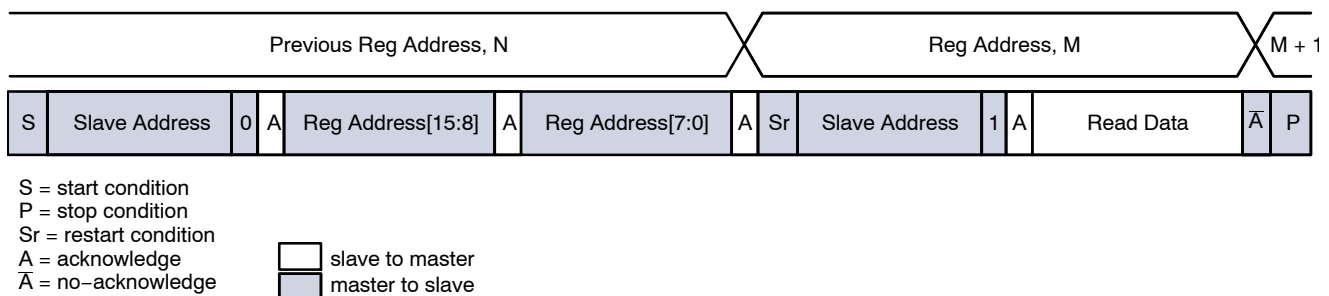

Figure 5. Single READ from Random Location

Single READ from Current Location

This sequence (Figure 6) performs a read using the current value of the AR0543 internal register address. The master

terminates the READ by generating a no-acknowledge bit followed by a stop condition. The figure shows two independent READ sequences.

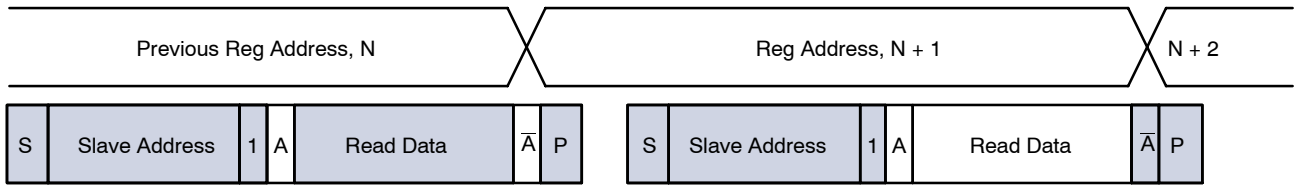

Figure 6. Single READ from Current Location

Sequential READ, Start from Random Location

This sequence (Figure 7) starts in the same way as the single READ from random location (Figure 5). Instead of generating a no-acknowledge bit after the first byte of data

has been transferred, the master generates an acknowledge bit and continues to perform byte READs until “L” bytes have been read.

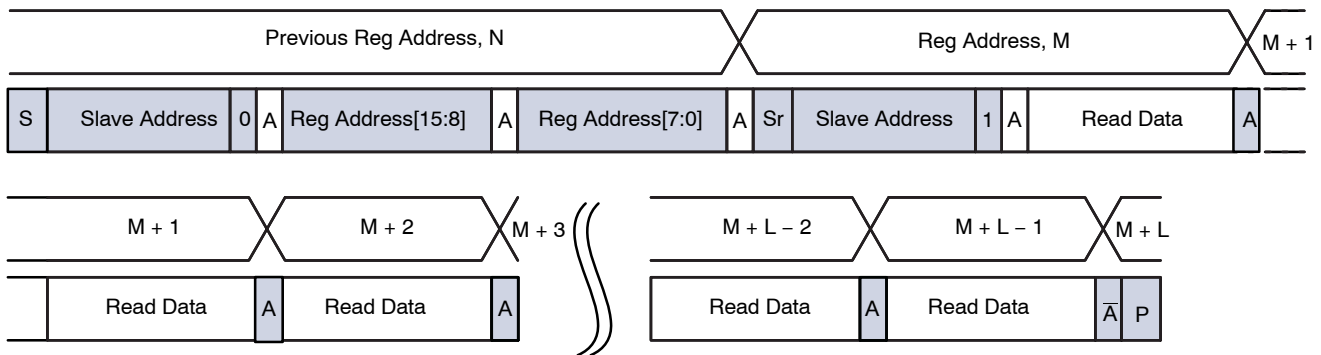

Figure 7. Sequential READ, Start from Random Location

Sequential READ, Start from Current Location

This sequence (Figure 8) starts in the same way as the single READ from current location (Figure 6 on page 8). Instead of generating a no-acknowledge bit after the first

byte of data has been transferred, the master generates an acknowledge bit and continues to perform byte READs until “L” bytes have been read.

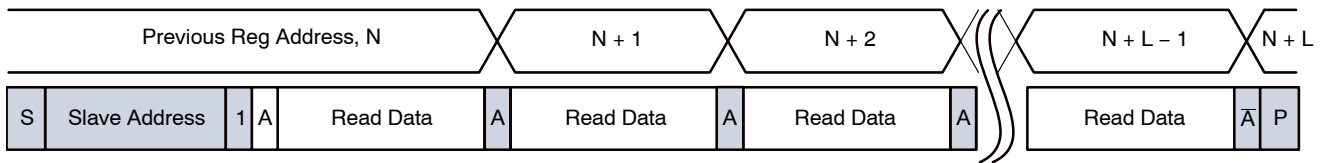

Figure 8. Sequential READ, Start from Current Location

Single WRITE to Random Location

This sequence (Figure 9) begins with the master generating a start condition. The slave address/data direction byte signals a WRITE and is followed by the HIGH

then LOW bytes of the register address that is to be written. The master follows this with the byte of write data. The WRITE is terminated by the master generating a stop condition.

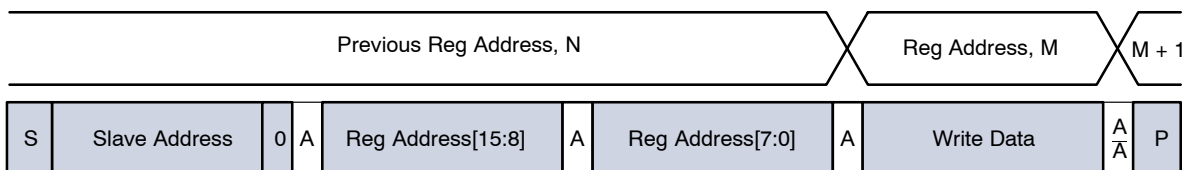

Figure 9. Single WRITE to Random Location

Sequential WRITE, Start at Random Location

This sequence (Figure 10) starts in the same way as the single WRITE to random location (Figure 9). Instead of generating a no-acknowledge bit after the first byte of data

has been transferred, the master generates an acknowledge bit and continues to perform byte WRITES until “L” bytes have been written. The WRITE is terminated by the master generating a stop condition.

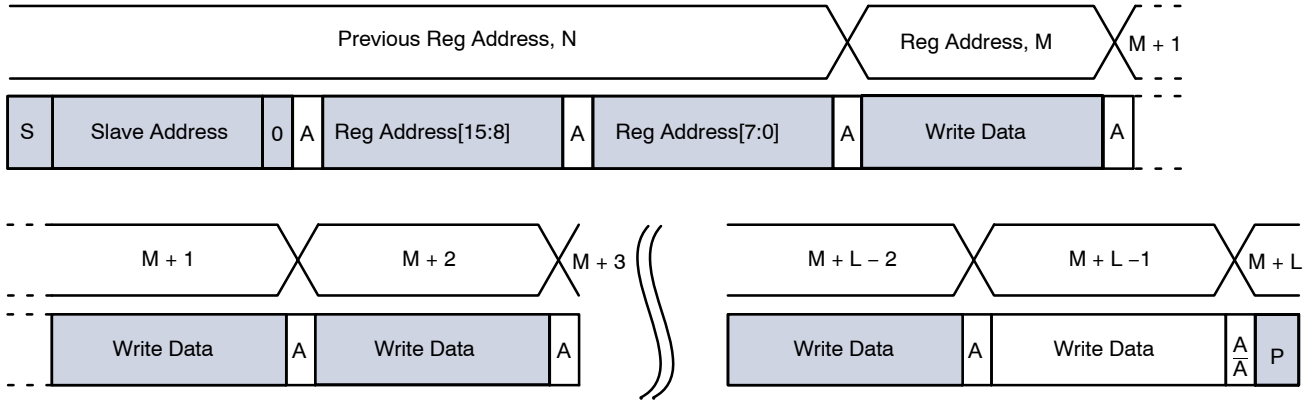

Figure 10. Sequential WRITE, Start at Random Location

Registers

The AR0543 provides a 16-bit register address space accessed through a serial interface (“[Two-Wire Serial](#)

[Register Interface](#)” on page 6). See Application note [AND9233](#) for details.

AR0543

PROGRAMMING RESTRICTIONS

Table 6 shows a list of programming rules that must be adhered to for correct operation of the AR0543. It is

recommended that these rules are encoded into the device driver stack – either implicitly or explicitly.

Table 5. DEFINITIONS FOR PROGRAMMING RULES

Name	Definition
xskip	$xskip = 1 \text{ if } x_odd_inc = 1; xskip = 2 \text{ if } x_odd_inc = 3; xskip = 4 \text{ if } x_odd_inc = 7$
yskip	$yskip = 1 \text{ if } y_odd_inc = 1; yskip = 2 \text{ if } y_odd_inc = 3; yskip = 4 \text{ if } y_odd_inc = 7$

Table 6. PROGRAMMING RULES

Parameter	Minimum Value	Maximum Value
coarse_integration_time	8	$frame_length_lines - coarse_integration_time_max_margin$
fine_integration_time	fine_integration_time_min	$line_length_pck - fine_integration_time_max_margin$
digital_gain_* digital_gain_* is an integer multiple of digital_gain_step_size	digital_gain_min	digital_gain_max
frame_length_lines	min_frame_length_lines	max_frame_length_lines
line_length_pck	min_line_length_pck	max_line_length_pck
	$((x_addr_end - x_addr_start + x_odd_inc)/xskip) + min_line_blinking_pck$	
frame_length_lines	$((y_addr_end - y_addr_start + y_odd_inc)/yskip) + min_frame_blinking_lines$	
x_addr_start (must be an even number)	x_addr_min	x_addr_max
x_addr_end (must be an odd number)	x_addr_start	x_addr_max
$(x_addr_end - x_addr_start + x_odd_inc)$	must be positive	must be positive
y_addr_start (must be an even number)	y_addr_min	y_addr_max
y_addr_end (must be an odd number)	y_addr_start	y_addr_max
$(y_addr_end - y_addr_start + y_odd_inc)$	must be positive	must be positive
x_even_inc (must be an even number)	min_even_inc	max_even_inc
y_even_inc (must be an even number)	min_even_inc	max_even_inc
x_odd_inc (must be an odd number)	min_odd_inc	max_odd_inc
y_odd_inc (must be an odd number)	min_odd_inc	max_odd_inc
scale_m	scaler_m_min	scaler_m_max
scale_n	scaler_n_min	scaler_n_max
x_output_size (must be even number – this is enforced in hardware)	256	2608
y_output_size (must be even number – this is enforced in hardware)	2	frame_length_lines
With subsampling, start and end pixels must be addressed (impact on x/y start/end addresses, function of image orientation bits)	-	-

Output Size Restrictions

When the serial pixel data path is in use, there is an additional restriction that $x_out - put_size$ must be small enough such that the output row time (set by x_output_size ,

the framing and CRC overhead of 12 bytes and the output clock rate) must be less than the row time of the video array (set by $line_length_pck$ and the video timing clock rate).

Effect of Scaler on Legal Range of Output Sizes

When the scaler is enabled, it is necessary to adjust the values of `x_output_size` and `y_output_size` to match the image size generated by the scaler. The AR0543 will operate incorrectly if the `x_output_size` and `y_output_size` are significantly larger than the output image.

To understand the reason for this, consider the situation where the sensor is operating at full resolution and the scaler is enabled with a scaling factor of 32 (half the number of pixels in each direction).

Output Data Timing

The output FIFO acts as a boundary between two clock domains. Data is written to the FIFO in the VT (video timing) clock domain. Data is read out of the FIFO in the OP (output) clock domain.

When the scaler is disabled, the data rate in the VT clock domain is constant and uniform during the active period of each pixel array row readout. When the scaler is enabled, the data rate in the VT clock domain becomes intermittent, corresponding to the data reduction performed by the scaler.

A key constraint when configuring the clock for the output FIFO is that the frame rate out of the FIFO must exactly match the frame rate into the FIFO. When the scaler is disabled, this constraint can be met by imposing the rule that the row time on the serial data stream must be greater than or equal to the row time at the pixel array. The row time on the serial data stream is calculated from the `x_output_size` and the `data_format` (8 or 10 bits per pixel), and must include the time taken in the serial data stream for start of frame/row, end of row/frame and checksum symbols.

Caution: If this constraint is not met, the FIFO will either underrun or overrun. FIFO underrun or over-run is a fatal error condition that is signaled through the `data_path_status` register (R0x306A).

Changing Registers while Streaming

The following registers should only be reprogrammed while the sensor is in software standby:

- `ccp_channel_identifier`
- `ccp_data_format`
- `ccp_signaling_mode`
- `vt_pix_clk_div`
- `vt_sys_clk_div`
- `pre_pll_clk_div`
- `pll_multiplier`
- `op_pix_clk_div`
- `op_sys_clk_div`
- `scale_m`

Programming Restrictions when Using Global Reset

Interactions between the registers that control the global reset imposes some programming restrictions on the way in which they are used; these are discussed in “[Analog Gain](#)” on page 28.

CONTROL OF THE SIGNAL INTERFACE

This section describes the operation of the signal interface in all functional modes.

Serial Register Interface

The serial register interface uses these signals:

- `S_CLK`
- `S_DATA`
- `S_ADDR` (through the GPI pad)

`S_CLK` is an input-only signal and must always be driven to a valid logic level for correct operation; if the driving device can place this signal in High-Z, an external pull-up resistor should be connected on this signal.

`S_DATA` is a bidirectional signal. An external pull-up resistor should be connected on this signal.

`S_ADDR` is a signal, which can be optionally enabled and controlled by a GPI pad, to select an alternate slave address. These slave addresses can also be programmed through R0x31FC.

This interface is described in detail in “[Two-Wire Serial Register Interface](#)” on page 39. The AR0543 sensor can provide the MIPI serial interface.

At power-up and after a hard or soft reset, the reset state of the sensor is to enable serial interface when available.

The serial pixel data interface uses the following output-only signal pairs:

- `DATA0_P`
- `DATA0_N`
- `CLK_P`
- `CLK_N`

The signal pairs are driven differentially using sub-LVDS switching levels. The serial pixel data interface is enabled by default at power up and after reset.

The `DATA0_P`, `DATA0_N`, `CLK_P`, and `CLK_N` pads are turned off if the SMIA serial disable bit is asserted (R0x301A-B[12] = 1) or when the sensor is in the soft standby state.

MIPI Serial Pixel Data Interface

The serial pixel data interface uses the following output-only signal pairs:

- `DATA0_P`
- `DATA0_N`
- `DATA1_P`
- `DATA1_N`
- `CLK_P`
- `CLK_N`

The signal pairs use both single-ended and differential signaling, in accordance with the MIPI specification. The serial pixel data interface is enabled by default at power up and after reset.

AR0543

The DATA0_P, DATA0_N, DATA1_P, DATA1_N, CLK_P and CLK_N pads are set to the Ultra Low Power State (ULPS) if the SMIA serial disable bit is asserted (R0x301A-B[12] = 1) or when the sensor is in the hardware standby or soft standby system states.

The ccp_data_format (R0x0112-3) register can be programmed to any of the following data format settings that are supported:

- 0x0A0A – Sensor supports RAW10 uncompressed data format. This mode is supported by discarding all but the upper 10 bits of a pixel value.
- 0x0808 – Sensor supports RAW8 uncompressed data format. This mode is supported by discarding all but the upper 8 bits of a pixel value.

- 0x0A08 – Sensor supports RAW8 data format in which an adaptive compression algorithm is used to perform 10-bit to 8-bit compression on the upper 10 bits of each pixel value

The serial_format register (R0x31AE) register controls which serial interface is in use when the serial interface is enabled (reset_register[12] = 0). The following serial formats are supported:

- 0x0201 – Sensor supports single-lane MIPI operation
- 0x0202 – Sensor supports dual-lane MIPI operation

Configuration of the Pixel Data Interface

Fields in R0x301A are used to configure the operation of the pixel data interface. The supported combinations are shown in Table 7.

Table 7. CONFIGURATION OF THE PIXEL DATA INTERFACE

Serializer Disable R0x301 A-B[12]	Parallel Enable R0x301A-B[7]	Standby End-of-Frame R0x301A-B[4]	Description
0	0	1	Power up default. Serial pixel data interface and its clocks are enabled. Transitions to soft standby are synchronized to the end of frames on the serial pixel data interface.

System States

The system states of the AR0543 are represented as a state diagram in Figure 11 and described in subsequent sections. The effect of RESET_BAR on the system state and the configuration of the PLL in the different states are shown in Table 8 on page 14.

The sensor's operation is broken down into three separate states: hardware standby, software standby, and streaming. The transition between these states might take a certain amount of clock cycles as outlined in Table 8 on page 14.

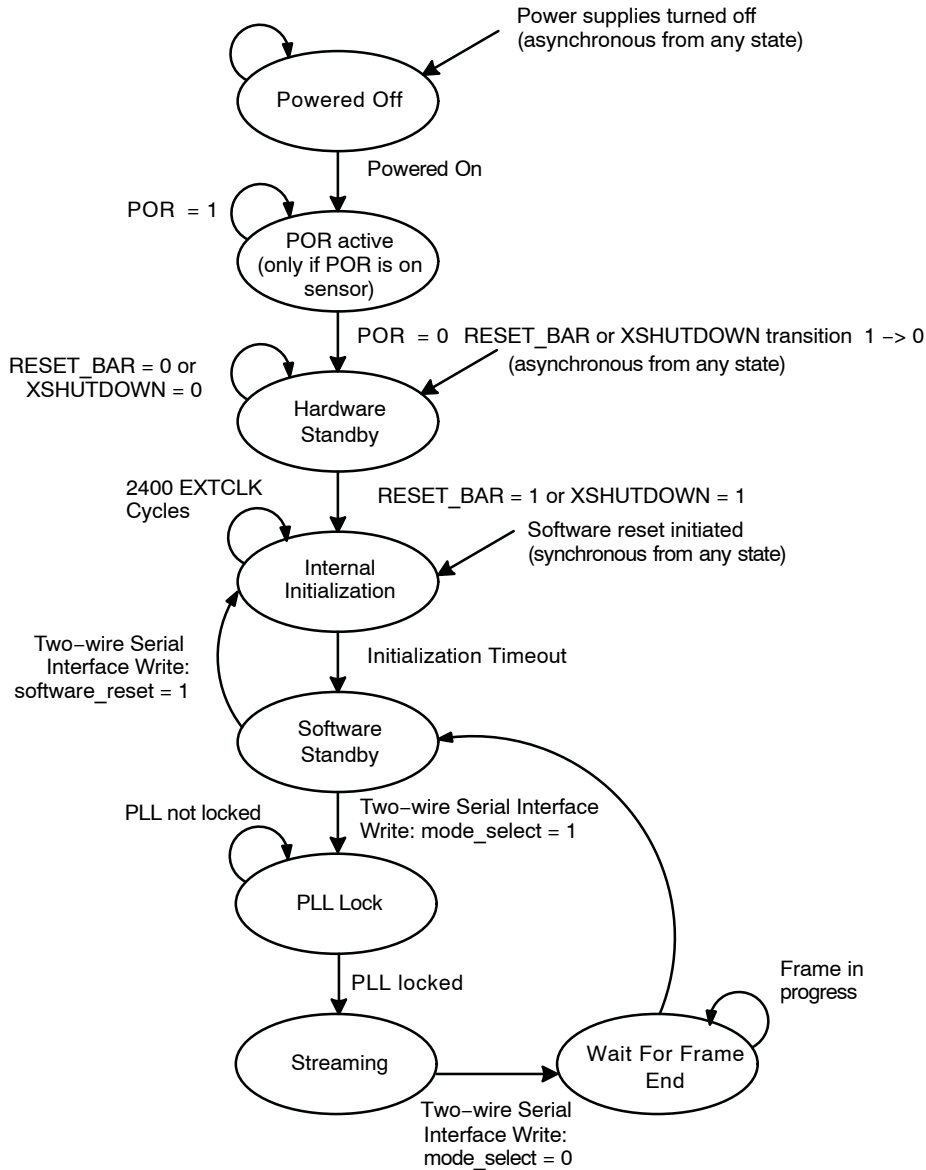

Figure 11. AR0543 System States

Table 8. XSHUTDOWN AND PLL IN SYSTEM STATES

State	XSHUTDOWN	PLL
Powered off	x	VCO powered down
POR active	x	
Hardware standby	0	
Internal initialization	1	
Software standby		
PLL Lock		VCO powering up and locking, PLL output bypassed
Streaming		VCO running, PLL output active
Wait for frame end		

Power-On Reset Sequence

When power is applied to the AR0543, it enters a low-power hardware standby state. Exit from this state is controlled by the later of two events:

- The negation of the XSHUTDOWN input.
- A timeout of the internal power-on reset circuit.

When XSHUTDOWN is asserted it asynchronously resets the sensor, truncating any frame that is in progress.

When the sensor leaves the hardware standby state it performs an internal initialization sequence that takes 2400 EXTCLK cycles. After this, it enters a low-power software standby state. While the initialization sequence is in progress, the AR0543 will not respond to read transactions on its two-wire serial interface. Therefore, a method to determine when the initialization sequence has completed is to poll a sensor register; for example, R0x0000. While the initialization sequence is in progress, the sensor will not respond to its device address and reads from the sensor will result in a NACK on the two-wire serial interface bus. When the sequence has completed, reads will return the operational value for the register (0x4800 if R0x0000 is read).

When the sensor leaves software standby mode and enables the VCO, an internal delay will keep the PLL disconnected for up to 1 ms so that the PLL can lock. The VCO lock time is 200 μ s (typical), 1 ms (maximum).

Soft Reset Sequence

The AR0543 can be reset under software control by writing “1” to software_reset (R0x0103). A software reset asynchronously resets the sensor, truncating any frame that is in progress. The sensor starts the internal initialization sequence, while the PLL and analog blocks are turned off. At this point, the behavior is exactly the same as for the power-on reset sequence.

Signal State During Reset

Table 9 shows the state of the signal interface during hardware standby (RESET_BAR asserted) and the default state during software standby (after exit from hardware standby and before any registers within the sensor have been changed from their default power-up values).

Table 9. SIGNAL STATE DURING RESET

Pad Name	Pad Type	Hardware Standby	Software Standby
EXTCLK	Input	Enabled. Must be driven to a valid logic level.	
XSHUTDOWN/RESET_BAR	Input	Enabled. Must be driven to a valid logic level.	
S _{CLK}	Input	Enabled. Must be pulled up or driven to a valid logic level.	
S _{DATA}	I/O	Enabled as an input. Must be pulled up or driven to a valid logic level.	
FLASH	Output	High-Z.	Logic 0.
DATA0_P	Output	MIPI: Ultra Low-Power State (ULPS), represented as an LP-00 state on the wire (both wires at 0 V).	
DATA0_N	Output		
DATA1_P	Output		
DATA1_N	Output		
CLK_P	Output		
CLK_N	Output		
GPI[3:0]	Input	Powered down. Can be left disconnected/floating.	
TEST	Input	Enabled. Must be driven to a logic 1 for a serial MIPI-configured sensor.	

General Purpose Inputs

The AR0543 provides four general purpose inputs. After reset, the input pads associated with these signals are powered down by default, allowing the pads to be left disconnected/floating.

The general purpose inputs are enabled by setting `reset_register[8]` (R0x301A). Once enabled, all four inputs must be driven to valid logic levels by external signals. The state of the general purpose inputs can be read through `gpi_status[3:0]` (R0x3026).

In addition, each of the following functions can be associated with none, one, or more of the general purpose inputs so that the function can be directly controlled by a hardware input:

- Standby functions
- `S_ADDR` selection (see “[Serial Register Interface](#)” on page 11)
The `gpi_status` register is used to associate a function with a general purpose input.

Streaming/Standby Control

The AR0543 can be switched between its soft standby and streaming states under pin or register control, as shown in Table 10. Selection of a pin to use for the STANDBY function is described in “[General Purpose Inputs](#)” on page 15. The state diagram for transitions between soft standby and streaming states is shown in Figure 11 on page 13.

Table 10. STREAMING/STANDBY

STANDBY	Streaming R0x301A–B[2]	Description
Disabled	0	Soft standby
Disabled	1	Streaming
X	0	Soft standby
0	1	Streaming
1	X	Soft standby

CLOCKING

The AR0543 contains a PLL for timing generation and control. The PLL contains a prescaler to divide the input clock applied on EXTCLK, a VCO to multiply the prescaler output, and a set of dividers to generate the output clocks.

Both SMIA profile 0 and profile 1/2 clock schemes are supported. Sensor profile level represents an increasing level of data rate reduction for video applications, for example, viewfinder in full resolution. The clocking scheme can be selected by setting R0x306E– F[7] to 0 for profile 0 or to 1 for profile 1/2.

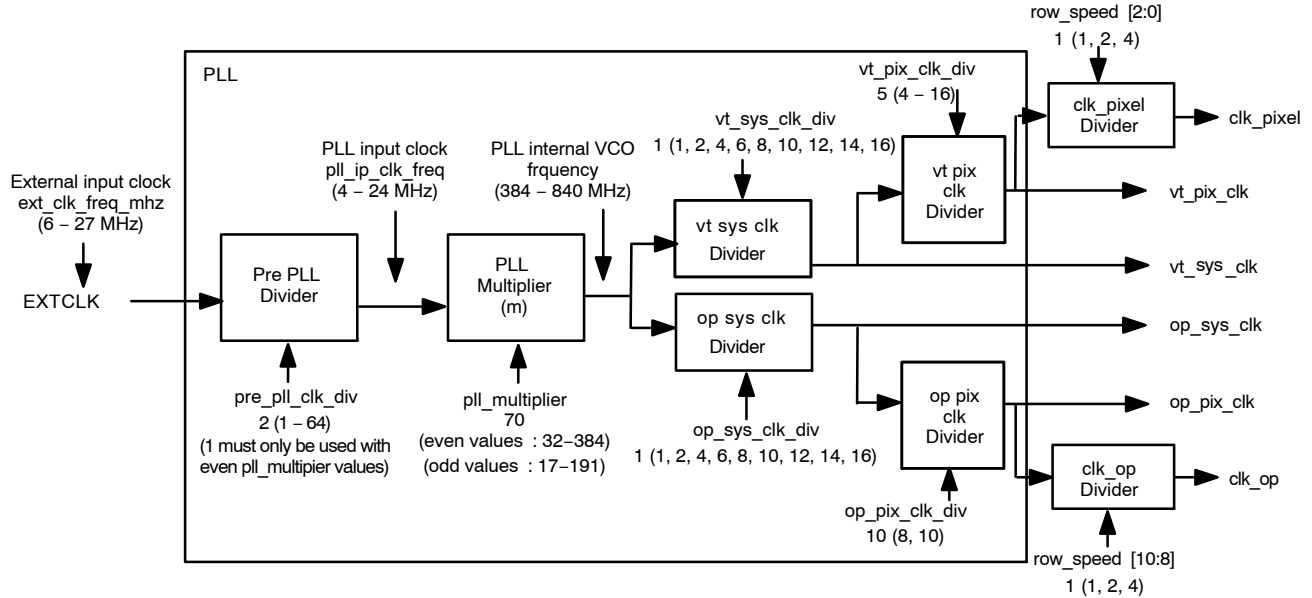

Figure 12. AR0543 Profile 1/2 Clocking Structure

Figure 12 shows the different clocks and the names of the registers that contain or are used to control their values. Also shown is the default setting for each divider/multiplier control register and the range of legal values for each divider/multiplier control register.

The parameter limit register space contains registers that declare the minimum and maximum allowable values for:

- The frequency allowable on each clock
 - The divisors that are used to control each clock
- These factors determine what are valid values, or combinations of valid values, for the divider/multiplier control registers:
- The minimum/maximum frequency limits for the associated clock must be met $pll_ip_clk_freq$ must be in the range 4 – 24 MHz. Higher frequencies are preferred. PLL internal VCO frequency must be in the range 384 – 840 MHz.
 - The minimum/maximum value for the divider/multiplier must be met.
Range for m : 17 – 384. (In addition odd values between 17 – 191 and even values between 32 – 384 are accepted.)
Range for n : 0 – 63. Range for $(n + 1)$: 1 – 64.
 - lk_op must never run faster than the clk_pixel to ensure that the output data stream is contiguous.
 - Given the maximum programmed line length, the minimum blanking time, the maximum image width, the available PLL divisor/multiplier values, and the

requirement that the output line time (including the necessary blanking) must be output in a time equal to or less than the time defined by $line_length_pck$.

Although the PLL VCO input frequency range is advertised as 4 – 24 MHz, superior performance is obtained by keeping the VCO input frequency as high as possible.

The usage of the output clocks is shown below:

- clk_pixel ($vt_pix_clk / row_speed[2:0]$) is used by the sensor core to readout and control the timing of the pixel array. The sensor core produces one 10-bit pixel each vt_pix_clk period. The line length ($line_length_pck$) and fine integration time ($fine_integration_time$) are controlled in increments of the vt_pix_clk period.
- clk_op ($op_pix_clk / row_speed[10:8]$) is used to load pixel data from the output FIFO (see Figure 24 on page 33) to the serializer. The output FIFO generates one pixel each op_pix_clk period. The pixel is either 8-bit or 10-bit, depending upon the output data format, controlled by R0x0112–3 ($ccpdata_format$).
- op_sys_clk is used to generate the serial data stream on the output. The relationship between this clock frequency and the op_pix_clk frequency is dependent upon the output data format.

In Profile 1/2, the output clock frequencies can be calculated as:

$$\text{clk_pix_freq_mhz} = \frac{\text{ext_clk_freq_mhz} \times \text{pll_multiplier} \times \text{clk_pixel_divN}}{\text{pre_pll_clk_div} \times \text{vt_sys_clk_div} \times \text{vt_pix_clk_div} \times \text{row_speed}[2 : 0]} \quad (\text{eq. 1})$$

$$\text{clk_op_freq_mhz} = \frac{\text{ext_clk_freq_mhz} \times \text{pll_multiplier}}{\text{pre_pll_clk_div} \times \text{op_sys_clk_div} \times \text{op_pix_clk_div} \times \text{row_speed}[10 : 8]} \quad (\text{eq. 2})$$

$$\text{op_sys_clk_freq_mhz} = \frac{\text{ext_clk_freq_mhz} \times \text{pll_multiplier}}{\text{pre_pll_clk_div} \times \text{op_sys_clk_div}} \quad (\text{eq. 3})$$

NOTE: For dual-lane MIPI interface, $\text{clk_pixel_divN} = 1$. For the single-lane MIPI interface, $\text{clk_pixel_divN} = 2$.

In Profile 0, RAW10 data format is required. As a result, op_pix_clk_div should be set to 10. Also, due to the inherent design of the AR0543 sensor, vt_pix_clk_div should be set to 5 for profile 0 mode.

PLL Clocking

The PLL divisors should be programmed while the AR0543 is in the software standby state. After programming the divisors, it is necessary to wait for the VCO lock time before enabling the PLL. The PLL is enabled by entering the streaming state.

An external timer will need to delay the entrance of the streaming mode by 1 millisecond so that the PLL can lock.

The effect of programming the PLL divisors while the AR0543 is in the streaming state is undefined.

Influence of ccp_data_format

R0x0112–3 (ccp_data_format) controls whether the pixel data interface will generate 10 or 8 bits per pixel.

When the pixel data interface is generating 8 bits per-pixel, op_pix_clk_div must be programmed with the value 8. When the pixel data interface is generating 10 bits per pixel, op_pix_clk_div must be programmed with the value 10.

Influence of ccp2_signalling_mode

R0x0111 ($\text{ccp2_signalling_mode}$) controls whether the serial pixel data interface uses data/strobe signaling or data/clock signaling.

When data/clock signaling is selected, the pll_multiplier supports both odd and even values.

When data/strobe signaling is selected, the pll_multiplier only supports even values; the least significant bit of the programmed value is ignored and treated as “0.”

This behavior is a result of the implementation of the CCP serializer and the PLL. When the serializer is using data and strobe signaling, it uses both edges of the op_sys_clk , and therefore that clock runs at one half of the bit rate. All of the programmed divisors are set up to make this behavior invisible. For example, when the divisors are programmed to generate a PLL output of 640 MHz, the actual PLL output is 320 MHz, but both edges are used.

When the serializer is using data and clock signaling, it uses a single edge on the op_sys_clk , and therefore that clock runs at the bit rate.

To disguise this behavior from the programmer, the actual PLL multiplier is right-shifted by one bit relative to the

programmed value when $\text{ccp2_signalling_mode}$ selects data/strobe signaling.

Clock Control

The AR0543 uses an aggressive clock-gating methodology to reduce power consumption. The clocked logic is divided into a number of separate domains, each of which is only clocked when required.

When the AR0543 enters a low-power state, almost all of the internal clocks are stopped. The only exception is that a small amount of logic is clocked so that the two-wire serial interface continues to respond to read and write requests.

FEATURES

Shading Correction (SC)

Lenses tend to produce images whose brightness is significantly attenuated near the edges. There are also other factors causing fixed pattern signal gradients in images captured by image sensors. The cumulative result of all these factors is known as image shading. The AR0543 has an embedded shading correction module that can be programmed to counter the shading effects on each individual Red, GreenB, GreenR, and Blue color signal.

The Correction Function

Color-dependent solutions are calibrated using the sensor, lens system and an image of an evenly illuminated, featureless gray calibration field. From the resulting image, register values for the color correction function (coefficients) can be derived.

The correction functions can then be applied to each pixel value to equalize the response across the image as follows:

$$P_{\text{corrected}}(\text{row}, \text{col}) = P_{\text{sensor}}(\text{row}, \text{col}) \times f(\text{row}, \text{col}) \quad (\text{eq. 4})$$

where P are the pixel values and f is the color dependent correction functions for each color channel.

Each function includes a set of color-dependent coefficients defined by registers R0x3600–3726. The function’s origin is the center point of the function used in the calculation of the coefficients. Using an origin near the central point of symmetry of the sensor response provides the best results. The center point of the function is determined by ORIGIN_C (R0x3782) and ORIGIN_R (R0x3784) and can be used to counter an offset in the system lens from the center of the sensor array.

One-Time Programmable Memory (OTPM)

The AR0543 features 4 Kb of one-time programmable memory (OTPM) for storing shading correction

coefficients, individual module ID, and sensor specific information. It takes 1632 bits to store one set of illumination-dependent shading coefficients. The OTPM array has a total of 125 accessible row-addresses, with each row having two 20-bit words per row. In each word, 16 bits are used for data storage, while the remaining 4 bits are used by the error detection and correction scheme. OTP memory can be accessed through two-wire serial interface. The AR0543 uses the auto mode for fast OTPM programming and read operations.

During the programming process, a dedicated high voltage pin (V_{PP}) needs to be supplied with a 6.5 V $\pm 3\%$ voltage to perform the anti-fusing operation, and a slew rate of 1 V/ μ s or slower is recommended for V_{PP} supply. Instantaneous V_{PP} cannot exceed 9 V at any time. The completion of the programming process will be communicated by a register through the two-wire serial interface.

Because this programming pin needs to sustain a higher voltage than other input/ output pins, having a dedicated high voltage pin (V_{PP}) minimizes the design risk. If the module manufacturing process can probe the sensor at the die or PCB level (that is, supply all the power rails, clocks, and two-wire serial interface signals), then this dedicated high voltage pin does not need to be assigned to the module connector pinout. However, if the V_{PP} pin needs to be bonded out as a pin on the module, the trace for V_{PP} needs to carry a maximum of 1 mA – for programming only. This pin should be left floating once the module is integrated to a design. If the V_{PP} pin does not need to be bonded-out as a pin on the module, it should be left floating inside the module.

The programming of the OTPM requires the sensor to be fully powered and remain in software standby with its clock input applied. The information will be programmed through the use of the two-wire serial interface, and once the data is written to an internal register, the programming host machine will apply a high voltage to the programming pin, and send a program command to initiate the anti-fusing process. After the sensor has finished programming the OTPM, a status bit will be set to indicate the end of the programming cycle, and the host machine can poll the setting of the status bit through the two-wire serial interface. Only one programming cycle for the 16-bit word can be performed.

Reading the OTPM data requires the sensor to be fully powered and operational with its clock input applied. The data can be read through a register from the two-wire serial interface.

Programming the OTPM

Program the AR0543 OTPM as follows:

1. Apply power to all the power rails of the sensor (V_{DD_IO} , V_{AA} , V_{AA_PIX} , and Digital 1.8 V).
 - ◆ onsemi recommends setting V_{AA} to 3.1 V during the programming process. All other supplies must be at their nominal voltage.

- ◆ Ensure that the V_{PP} pin is floating during sensor power-up.
2. Provide an EXTCLK clock input (12 MHz is recommended).
 3. Set R0x301A = 0x10D8, to put sensor in the soft standby mode.
 4. Set R0x3064[9] = 1 to bypass PLL.
 5. Set R0x3054[8] = 1
 6. Write data (102 words for one set of LSC coefficients) into the OTPM data registers (R0x3800–R0x38CA for one set of LSC coefficients).
 7. Set OTPM start address register R0x3050[15:8] = 0 to program the array with the first batch of data.

NOTE: When programming the second batch of data, set the start address to 128 (considering that all the previous 0 – 127 locations are already written to by the data registers 0 – 255), otherwise the start address should be set accordingly.

8. Set R0x3054[9] = 0 to ensure that the error checking and correction is enabled.
9. Set the length register (R0x304C [7:0]) accordingly, depending on the number of OTM data registers that are filled in (0x66 for 102 words). It may take about 500 ms for one set of LSC (102 words).
10. Set R0x3052 = 0x2504 (OTPM_CONFIG)
11. Ramp up V_{PP} to 6.5 V. The recommended slew rate for V_{PP} is 1 V/ μ s or slower.
12. Set the otpm_control_auto_wr_start bit in the otpm_manual_control register R0x304A[0] = 1, to initiate the auto program sequence. The sensor will now program the data into the OTPM starting with the location specified by the start address.
13. Poll OTPM_Control_Auto_WR_end (R0x304A [1]) to determine when the sensor is finished programming the word.
14. Repeat steps 13 and 14.
15. Remove the high voltage (V_{PP}) and float the V_{PP} pin.

Reading the OTPM

Read the AR0543 OTPM as follows:

1. Perform the proper reset sequence to the sensor by setting R0x0103 = 1.
2. Set OTPM_CONFIG register R0x3052 = 0x2704.
3. Set R0x3054[8] = 1.
4. Program R0x3050[15:8] with the appropriate value to specify the start address (0x0 for address 0).
5. Program R0x304C [7:0] with the appropriate value to specify the length (number of data registers to be read back, starting from the specified start address – 0x66 for 102 words).

6. Initiate the auto read sequence by setting the `otpm_control_auto_read_start` bit `R0x304A[4] = 1`.
7. Poll the `otpm_control_auto_rd_end` bit (`R0x304A[5]`) to determine when the sensor is finished reading the word(s).
Data can now be read back from the `otpm_data` registers (`R0x3800–R0x39FE`).
8. Verify that the read data from the `OTPM_DATA` registers are the expected data.

Image Acquisition Mode

The AR0543 supports the electronic rolling shutter (ERS) mode. This is the normal mode of operation. When the AR0543 is streaming, it generates frames at a fixed rate, and each frame is integrated (exposed) using the ERS. When the ERS is in use, timing and control logic within the sensor sequences through the rows of the array, resetting and then reading each row in turn. In the time interval between resetting a row and subsequently reading that row, the pixels in the row integrate incident light. The integration (exposure) time is controlled by varying the time between row reset and row readout. For each row in a frame, the time between row reset and row readout is fixed, leading to a uniform integration time across the frame. When the integration time is changed (by using the two-wire serial interface to change register settings), the timing and control logic controls the transition from old to new integration time in such a way that the stream of output frames from the AR0543 switches cleanly from the old integration time to the new while only generating frames with uniform integration. See “Changes to Integration time” in the Application note [AND9233](#).

Window Control

The sequencing of the pixel array is controlled by the `x_addr_start`, `y_addr_start`, `x_addr_end`, and `y_addr_end` registers. For serial MIPI interfaces, the output image size is controlled by the `x_output_size` and `y_output_size` registers.

Pixel Border

The default settings of the sensor provide a 2592 H x 1944 V image. A border of up to 8 pixels (4 in binning) on each edge can be enabled by reprogramming the `x_addr_start`, `y_addr_start`, `x_addr_end`, `y_addr_end`, `x_output_size`, and `y_output_size` registers accordingly.

Readout Modes

Horizontal Mirror

When the `horizontal_mirror` bit is set in the `image_orientation` register, the order of pixel readout within a row is reversed, so that readout starts from `x_addr_end` and ends at `x_addr_start`. Enabling `horizontal_mirror` causes the Bayer order of the output image to change; the new Bayer order is reflected in the value of the `pixel_order` register.

Vertical Flip

When the `vertical_flip` bit is set in the `image_orientation` register, the order in which pixel rows are read out is reversed, so that row readout starts from `y_addr_end` and ends at `y_addr_start`.

Subsampling

The AR0543 supports subsampling. Subsampling reduces the amount of data processed by the analog signal chain in the AR0543 thereby allowing the frame rate to be increased. Subsampling is enabled by setting `x_odd_inc` and/or `y_odd_inc`. Values of 1, 3, and 7 can be supported. Setting both of these variables to 3 reduces the amount of row and column data processed and is equivalent to the 2 x 2 skipping readout mode provided by the AR0543. Setting `x_odd_inc = 3` and `y_odd_inc = 3` results in a quarter reduction in output image size.

A 1/16 reduction in resolution is achieved by setting both `x_odd_inc` and `y_odd_inc` to 7. This is equivalent to 4 x 4 skipping readout mode provided by the AR0543.

The effect of the different subsampling settings on the pixel array readout is shown in Figure 13 through Figure 15 on page 20.

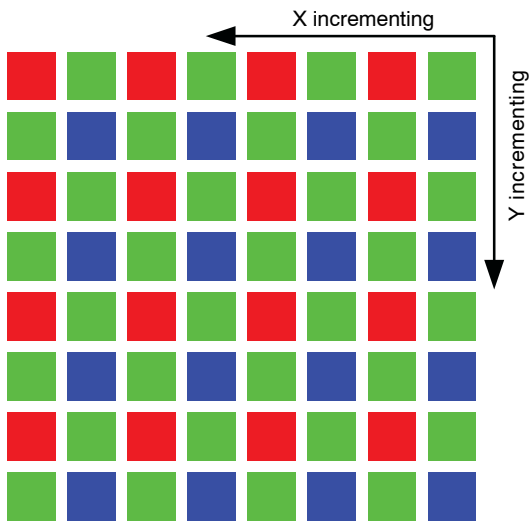

Figure 13. Pixel Readout (No Subsampling)

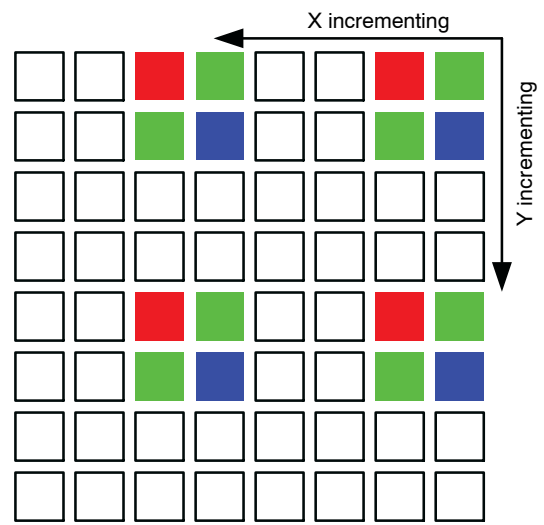

Figure 14. Pixel Readout ($x_odd_inc = 3, y_odd_inc = 3$)

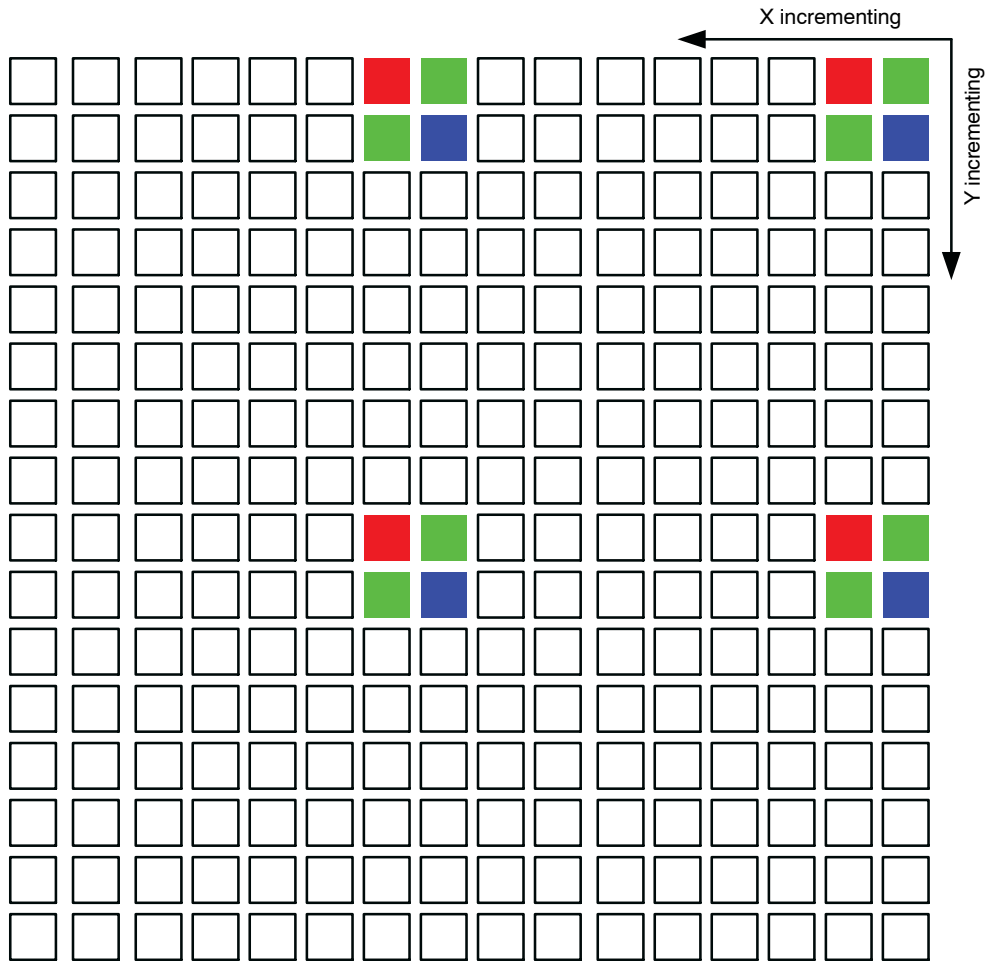

Figure 15. Pixel Readout ($x_odd_inc = 7, y_odd_inc = 7$)

Programming Restrictions when Subsampling

When subsampling is enabled as a viewfinder mode and the sensor is switched back and forth between full resolution and subsampling, **onsemi** recommends that `line_length_pck` be kept constant between the two modes. This allows the same integration times to be used in each mode.

When subsampling is enabled, it may be necessary to adjust the `x_addr_end`, `x_addr_start`, `y_addr_start`, and `y_addr_end` settings: the values for these registers are required to correspond with rows/columns that form part of the subsampling sequence. The adjustment should be made in accordance with these rules:

$$x_skip_factor = (x_odd_inc + 1) / 2$$

$$y_skip_factor = (y_odd_inc + 1) / 2$$

- `x_addr_start` should be a multiple of `x_skip_factor * 4`
- $(x_addr_end - x_addr_start + x_odd_inc)$ should be a multiple of `x_skip_factor * 4`
- $(y_addr_end - y_addr_start + y_odd_inc)$ should be a multiple of `y_skip_factor * 4`

The number of columns/rows read out with subsampling can be found from the equation below:

- $columns/rows = (addr_end - addr_start + odd_inc) / skip_factor$

Example:

The sensor is set up to give out a full resolution 2592 x 1944 image:

[full resolution starting address with (8, 8)]

```
REG = 0x0104, 1 //GROUPED_PARAMETER_HOLD
REG = 0x0382, 1 //X_ODD_INC
REG = 0x0386, 1 //Y_ODD_INC
REG = 0x0344, 8 //X_ADDR_START
REG = 0x0346, 8 //Y_ADDR_START
REG = 0x0348, 2599 //X_ADDR_END
REG = 0x034A, 1951 //Y_ADDR_END
```

```
REG = 0x034C, 2592 //X_OUTPUT_SIZE
REG = 0x034E, 1944 //Y_OUTPUT_SIZE
REG = 0x0104, 0 //GROUPED_PARAMETER_HOLD
```

To halve the resolution in each direction (1296 x 972), the registers need to be reprogrammed as follows:

[2 x 2 skipping starting address with (8, 8)]

```
REG = 0x0104, 1 //GROUPED_PARAMETER_HOLD
REG = 0x0382, 3 //X_ODD_INC
REG = 0x0386, 3 //Y_ODD_INC
REG = 0x0344, 8 //X_ADDR_START
REG = 0x0346, 8 //Y_ADDR_START
REG = 0x0348, 2597 //X_ADDR_END
REG = 0x034A, 1949 //Y_ADDR_END
REG = 0x034C, 1296 //X_OUTPUT_SIZE
REG = 0x034E, 972 //Y_OUTPUT_SIZE
REG = 0x0104, 0 //GROUPED_PARAMETER_HOLD
```

To quarter the resolution in each direction (648 x 486), the registers need to be reprogrammed as follows:

[4 x 4 skipping starting address with (8, 8)]

```
REG = 0x0104, 1 //GROUPED_PARAMETER_HOLD
REG = 0x0382, 7 //X_ODD_INC
REG = 0x0386, 7 //Y_ODD_INC
REG = 0x0344, 8 //X_ADDR_START
REG = 0x0346, 8 //Y_ADDR_START
REG = 0x0348, 2593 //X_ADDR_END
REG = 0x034A, 1945 //Y_ADDR_END
REG = 0x034C, 648 //X_OUTPUT_SIZE
REG = 0x034E, 486 //Y_OUTPUT_SIZE
REG = 0x0104, 0 //GROUPED_PARAMETER_HOLD
```

Table 11 shows the row or column address sequencing for normal and subsampled readout. In the 2X skip case, there are two possible subsampling sequences (because the subsampling sequence only reads half of the pixels) depending upon the alignment of the start address. Similarly, there will be four possible subsampling sequences in the 4X skip case (though only the first two are shown in Table 11).

Table 11. ROW ADDRESS SEQUENCING DURING SUBSAMPLING

odd_inc = 1 – Normal	odd_inc = 3, 2X Skip	odd_inc = 7, 4X Skip
start = 0	start = 0	start = 0
0	0	0
1	1	1
2	–	–
3	–	–
4	4	–
5	5	–
6	–	–
7	–	–
8	8	8
9	9	9
10	–	–
11	–	–
12	12	–
13	13	–
14	–	–
15	–	–

Binning

The AR0543 supports 2 x 1 (column binning, also called x-binning) and 2 x 2 analog binning (row/column binning, also called xy-binning). Binning has many of the same characteristics as subsampling, but because it gathers image data from all pixels in the active window (rather than a subset of them), it achieves superior image quality and avoids the aliasing artifacts that can be a characteristic side effect of subsampling.

Binning is enabled by selecting the appropriate subsampling settings (odd_inc = 3 and y_odd_inc = 1 for x-binning, x_odd_inc = 3 and y_odd_inc = 3 for xy-binning) and setting the appropriate binning bit in read_mode (R0x3040–1). As with subsampling, x_addr_end and y_addr_end may require adjustment when

binning is enabled. It is the first of the two columns/rows binned together that should be the end column/row in binning, so the requirements to the end address are exactly the same as in non-binning subsampling mode. The effect of the different subsampling settings is shown in Figure 17 and Figure 16 on page 23.

Binning can also be enabled when the 4X subsampling mode is enabled (x_odd_inc = 7 and y_odd_inc = 1 for x-binning, x_odd_inc = 7 and y_odd_inc = 7 for xy-binning). In this mode, however, not all pixels will be used so this is not a 4X binning implementation. An implementation providing a combination of skip2 and bin2 is used to achieve 4X subsampling with better image quality. The effect of this subsampling mode is shown in Figure 18 on page 23.

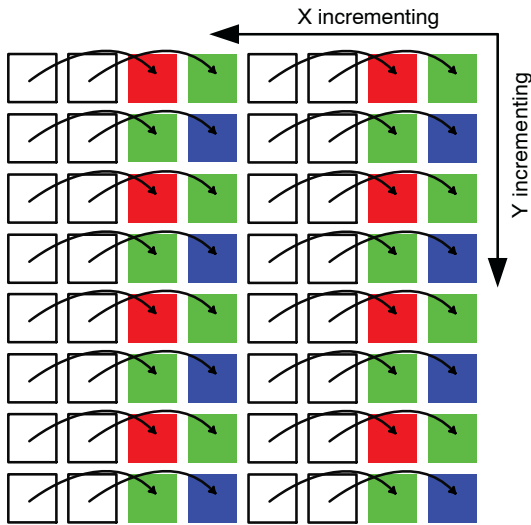

Figure 17. Pixel Readout ($x_odd_inc = 3$, $y_odd_inc = 1$, $x_bin = 1$)

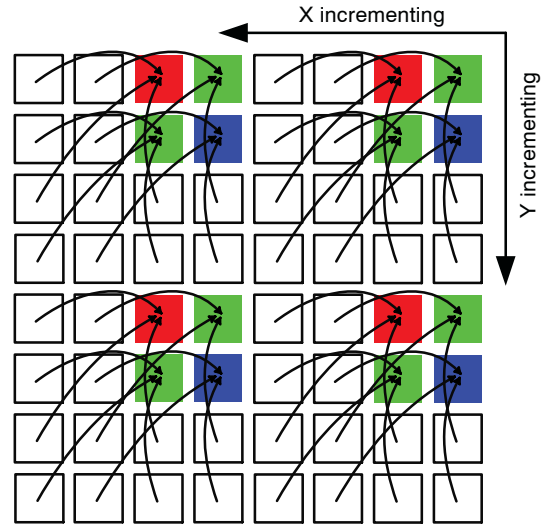

Figure 16. Pixel Readout ($x_odd_inc = 3$, $y_odd_inc = 3$, $xy_bin = 1$)

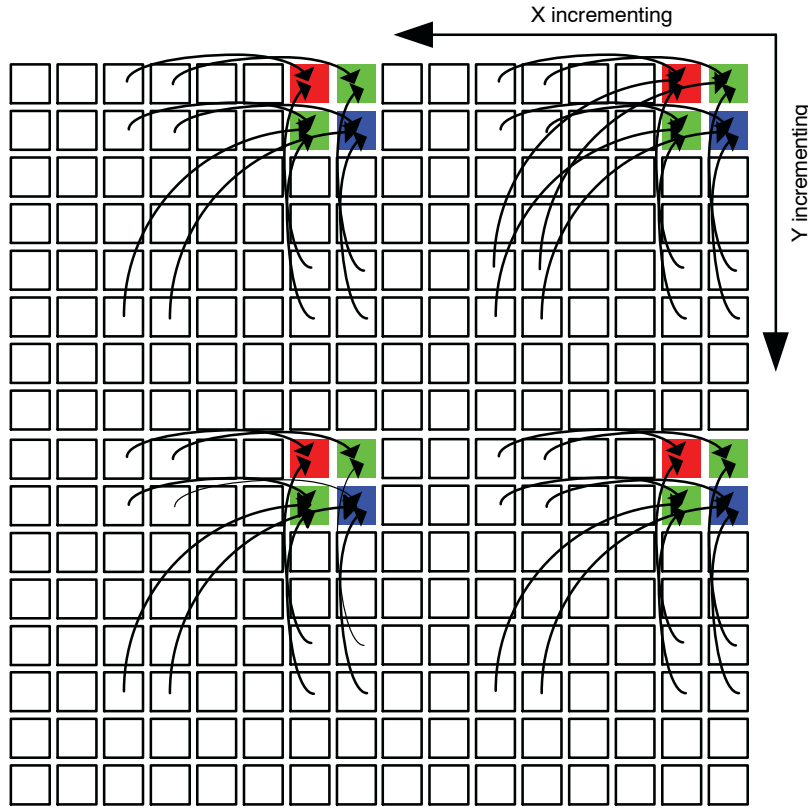

Figure 18. Pixel Readout ($x_odd_inc = 7$, $y_odd_inc = 7$, $xy_bin = 1$)

AR0543

Binning address sequencing is a bit more complicated than during subsampling only, because of the implementation of the binning itself.

For a given column n , there is only one other column, n_{bin} , that can be binned with, because of physical limitations in the column readout circuitry. The possible address sequences are shown in Table 12.

Table 12. COLUMN ADDRESS SEQUENCING DURING BINNING

odd_inc = 1 – Normal	odd_inc = 3, 2X Bin	odd_inc = 7, 2X Skip + 2X Bin
x_addr_start = 0	x_addr_start = 0	x_addr_start = 0
0	0/2	0/4
1	1/3	1/5
2	–	–
3	–	–
4	4/6	–
5	5/7	–
6	–	–
7	–	–
8	8/10	8/12
9	9/11	9/13
10	–	–
11	–	–
12	12/14	–
13	13/15	–

There are no physical limitations on what can be binned together in the row direction. A given row n will always be binned with row $n+2$ in 2X subsampling mode and with row

$n+4$ in 4X subsampling mode. Therefore, which rows get binned together depends upon the alignment of y_addr_start . The possible sequences are shown in Table 13.

Table 13. ROW ADDRESS SEQUENCING DURING BINNING

odd_inc = 1 – Normal	odd_inc = 3, 2X Bin	odd_inc = 7, 2X Skip + 2X Bin
x_addr_start = 0	x_addr_start = 0	x_addr_start = 0
0	0/2	0/4
1	1/3	1/5
2	–	–
3	–	–
4	4/6	–
5	5/7	–
6	–	–
7	–	–
8	8/10	8/12
9	9/11	9/13
10	–	–
11	–	–
12	12/14	–
13	13/15	–
14	–	–
15	–	–

Programming Restrictions when Binning

Binning requires different sequencing of the pixel array and imposes different timing limits on the operation of the sensor. In particular, xy-binning requires two read operations from the pixel array for each line of output data, which has the effect of increasing the minimum line blanking time. The SMIA specification cannot accommodate this variation because its parameter limit registers are defined as being static.

As a result, when xy-binning is enabled, some of the programming limits declared in the parameter limit registers are no longer valid. In addition, the default values for some of the manufacturer-specific registers need to be reprogrammed. See section “[Minimum Frame Time](#)” on page 26, section “[Minimum Row Time](#)” on page 26, and section “[Fine Integration Time Limits](#)” on page 27.

Table 14. READOUT MODES

Readout Modes	x_odd_inc, y_odd_inc	xy_bin
2x skip	3	0
2x bin	3	1
4x skip	7	0
2x skip + 2x bin	7	1

Scaler

Scaling is a “zoom out” operation to reduce the size of the output image while covering the same extent as the original image. Each scaled output pixel is calculated by taking a weighted average of a group of input pixels which is composed of neighboring pixels. The input and output of the scaler is in Bayer format.

When compared to skipping, scaling is advantageous because it uses all pixel values to calculate the output image which helps avoid aliasing. Also, it is also more convenient than binning because the scale factor varies smoothly and the user is not limited to certain ratios of size reduction.

The AR0543 sensor is capable of horizontal scaling and full (horizontal and vertical) scaling.

$$\text{ScaleFactor} = \text{Scale}_n / \text{scale}_m = 16 / \text{scale}_n \quad (\text{eq. 5})$$

The scaling factor, programmable in 1/16 steps, is used for horizontal and vertical scalers.

$$\text{minimum line_length_pck} = \left(\frac{\text{x_addr_end} - \text{x_addr_start} + 1}{\text{subsampling factor}} + \text{min_line_blanking_pck} \right) \quad (\text{eq. 6})$$

Note that `line_length_pck` also needs to meet the minimum line length requirement set in register `min_line_length_pck`. The row time can either be limited by the time it takes to sample and reset the pixel array for each row, or by the time it takes to sample and read out a row.

$$\text{minimum frame_length_lines} = \left(\frac{\text{y_addr_end} - \text{y_addr_start} + 1}{\text{subsampling factor}} + \text{min_frame_blanking_lines} \right) \quad (\text{eq. 7})$$

The frame rate can be calculated from these variables and the pixel clock speed as shown in Equation 8:

$$\text{frame rate} = \frac{\text{vt_pixel_clock_mhz} \times 1 \times 10^6}{\text{line_length_pck} \times \text{frame_length_lines}} \quad (\text{eq. 8})$$

The scale factor is determined by:

- n, which is fixed at 16
- m, which is adjustable with register R0x0404
- Legal values for m are 16 through 256, giving the user the ability to scale from 1:1 (m = 16) to 1:16 (m = 256).

For example, when horizontal and vertical scaling is enabled for a 1:2 scale factor, an image is reduced by half in both the horizontal and vertical directions. This results in an output image that is one-fourth of the original image size. This can be achieved with the following register settings:

```
R0x0400 = 0x0002 // horizontal and
vertical scaling mode
R0x0402 = 0x0020 // scale factor m = 32
```

Frame Rate Control

The formulas for calculating the frame rate of the AR0543 are shown below.

The line length is programmed directly in pixel clock periods through register `line_length_pck`. For a specific window size, the minimum line length can be found from in Equation 6:

Values for `min_line_blanking_pck` are provided in “[Minimum Row Time](#)” on page 26.

The frame length is programmed directly in number of lines in the register `frame_line_length`. For a specific window size, the minimum frame length can be found in Equation 7:

If `coarse_integration_time` is set larger than `frame_length_lines` the frame size will be expanded to `coarse_integration_time + 1`.

Minimum Row Time

The minimum row time and blanking values with default register settings are shown in Table 15.

Table 15. MINIMUM ROW TIME AND BLANKING NUMBERS

	No Row Binning			Row Binning		
	1	2	4	1	2	4
row_speed[2:0]	1	2	4	1	2	4
min_line_blanking_pck	0x044E	0x02B6	0x01E8	0x073C	0x040C	0x0274
min_line_length_pck	0x0590	0x03F8	0x0330	0x0940	0x0550	0x03B8

Minimum Frame Time

In addition, enough time must be given to the output FIFO so it can output all data at the set frequency within one row time.

There are therefore three checks that must all be met when programming `line_length_pck`:

- $line_length_pck \geq min_line_length_pck$ in Table 15.
- $line_length_pck \geq (x_addr_end - x_addr_start + x_odd_inc) / ((1+x_odd_inc) / 2) + min_line_blanking_pck$ in Table 15.
- The row time must allow the FIFO to output all data during each row. That is, $line_length_pck \geq (x_output_size * 2 + 0x005E) * "vt_pix_clk\ period" / "op_pix_clk\ period"$

The minimum number of rows in the image is 2, so `min_frame_length_lines` will always equal $(min_frame_blanking_lines + 2)$.

Table 16. MINIMUM FRAME TIME AND BLANKING NUMBERS

	No Row Binning	Row Binning
min_frame_blanking_lines	0x004D	0x0049
min_frame_length_lines	0x005D	0x0059

Integration Time

The integration (exposure) time of the AR0543 is controlled by the `fine_integration_time` and `coarse_integration_time` registers.

The limits for the fine integration time are defined by:

$$fine_integration_time_min \leq fine_integration_time \leq (line_length_pck - fine_integration_time_max_margin) \quad (eq. 9)$$

The limits for the coarse integration time are defined by:

$$coarse_integration_time_min \leq coarse_integration_time \quad (eq. 10)$$

The actual integration time is given by:

$$integration_time = \frac{((coarse_integration_time \times line_length_pck) + fine_integration_time)}{(vt_pix_clk_freq_mhz \times 10^6)} \quad (eq. 11)$$

It is required that:

$$coarse_integration_time \leq (frame_length_lines - coarse_integration_time_max_margin) \quad (eq. 12)$$

If this limit is broken, the frame time will automatically be extended to $coarse_integration_time + coarse_integration_time_max_margin$ to accommodate the larger integration time.

In binning mode, `frame_length_lines` should be set larger than `coarse_integration_time` by at least 3 to avoid column imbalance artifact.

Fine Integration Time Limits

The limits for the *fine_integration_time* can be found from *fine_integration_time_min* and

fine_integration_time_max_margin. Values for different mode combinations are shown in Table 17.

Table 17. fine_integration_time LIMITS

	No Row Binning			Row Binning		
row_speed[2:0]	1	2	4	1	2	4
fine_integration_time_min	0x02CE	0x0178	0x006E	0x0570	0x02C8	0x00C2
fine_integration_time_max_margin	0x0159	0x00AD	0x00AD	0x02B9	0x015D	0x0149

fine_correction

For the *fine_integration_time* limits, the *fine_correction* constant will change with the pixel clock speed and binning mode. It is necessary to change *fine_correction* (R0x3010)

when binning is enabled or the pixel clock divider (*row_speed*[2:0]) is used. The corresponding *fine_correction* values are shown in Table 18.

Table 18. fine_correction VALUES

	No Row Binning			Row Binning		
row_speed[2:0]	1	2	4	1	2	4
fine_correction	0x00A0	0x004A	0x001F	0x0140	0x009A	0x0047

Flash Timing Control

The AR0543 supports both Xenon and LED flash timing through the FLASH output signal. The timing of the FLASH signal with the default settings is shown in Figure 19 (Xenon) and Figure 20 (LED). The flash and flash_count registers allow the timing of the flash to be changed. The flash can be programmed to fire only once, delayed by a few frames when asserted, and (for xenon flash) the flash duration can be programmed.

integration time. This can be avoided either by first enabling mask bad frames (write *reset_register*[9] = 1) before the enabling the flash or by forcing a restart (write *reset_register*[1] = 1) immediately after enabling the flash; the first bad frame will then be masked out, as shown in Figure 20 on page 27. Read-only bit *flash*[14] is set during frames that are correctly integrated; the state of this bit is shown in Figures 19 and Figure 20.

Enabling the LED flash will cause one bad frame, where several of the rows only have the flash on for part of their

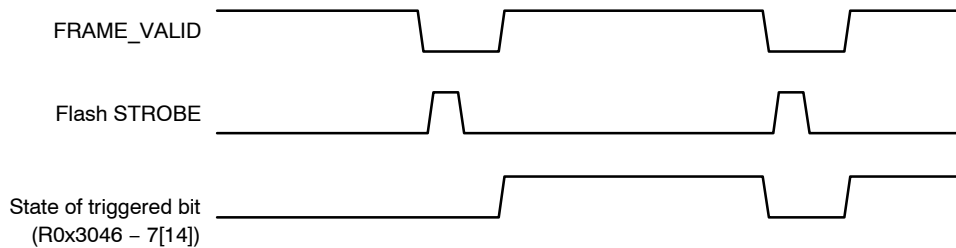
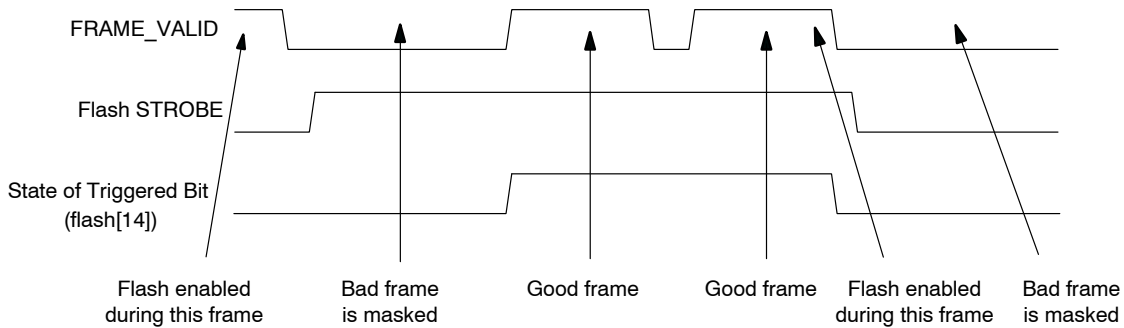

Figure 19. Xenon Flash Enabled



NOTE: An option to invert the flash output signal through R0x3046[7] is also available.

Figure 20. LED Flash Enabled

AR0543

Analog Gain

The following sections describe the **onsemi** gain model for AR0543 and the different gain stages and gain control.

Using Per-color or Global Gain Control

The read-only analogue_gain_capability register returns a value of “1,” indicating that the AR0543 provides per-color gain control. However, the AR0543 also provides

the option of global gain control. Per-color and global gain control can be used interchangeably. A write to a global gain register is aliased as a write of the same data to the four associated color-dependent gain registers. A read from a global gain register is aliased to a read of the associated greenR gain register.

Table 19. GAIN REGISTERS

	Bits	Default	Name	Frame Sync'd	Bad Frame
Register	15:0	0x1050	global_gain (R/W)	N	N
	15:1 2	0x0001	digital_gain Digital Gain. Legal values 1 – 7.		
	11:1 0	0x0000	col_gain This is the column gain Valid values for bits[11:10] are: 00: 1x 01: 3x 10: 2x 11: 4x	Y	Y
	9:8	0x0000	asc1_gain This is the ASC1 gain Valid values for bits[9:8] are: 00: 1x 01: 1.3x 10: 2x 11: 4x		
	7	0x0000	Reserved	Y	N
	6:0	0x0050	initial_gain Initial gain = bits [6:0] * 1/32.		
	Gain = Column Gain * ASC1 Gain * Initial_gain			Y	Y

onsemi Gain Model

The **onsemi** gain model uses these registers to set the analog gain:

- global_gain
- green1_gain

- red_gain
- blue_gain
- green2_gain

The AR0543 uses 11 bits analog gain control. The analog gain is given by:

$$\text{Total gain} = \text{Column_gain} \times \text{ASC1_gain} \times \text{Initial_gain} = \langle \text{color} \rangle_gain[11 : 10] \times \langle \text{color} \rangle_gain[9 : 8] \times \frac{\langle \text{color} \rangle_gain[6 : 0]}{32}$$

(eq. 13)

Valid Values	Column_gain (<color>_gain[11:10])	ASC_gain (<color>_gain[9:8])
2'b00	1X	1X
2'b01	3X	1.3X
2'b10	2X	2X
2'b11	4X	–

As a result, the step size varies depending upon which range the gain is in. Many of the possible gain settings can be achieved in different ways. However, the recommended gain setting is to use the Column_gain as much as possible instead of using ASC1_gain and Initial_gain for the desired gain setting, which will result lower noise. for the fine step,

the Initial gain should be used with Column_gain and ASC1_gain.

The recommended minimum analog gain for AR0543 is 1.6x(R0x305E = 0x1127). Table 20 provides the gain usage table that is a guide to program a specific gain value while optimizing the noise performance from the sensor.

Table 20. GAIN USAGE

Total Gain	Column Gain	ASC1 Gain	Initial Gain
$1.0 \leq \text{Gain} < 1.33$	1	1	$1.0 \leq \text{init} < 1.33$
$1.33 \leq \text{Gain} < 2.0$	1	1.33	$1.0 \leq \text{init} < 1.50$
$2.0 \leq \text{Gain} < 2.66$	2	1	$1.0 \leq \text{init} < 1.33$
$2.66 \leq \text{Gain} < 3.0$	2	1.33	$1.0 \leq \text{init} < 1.15$
$3.0 \leq \text{Gain} < 4.0$	3	1	$1.0 \leq \text{init} < 1.33$
$4.0 \leq \text{Gain} < 5.3$	4	1	$1.0 \leq \text{init} < 1.33$
$5.3 \leq \text{Gain} < 8.0$	4	1.33	$1.0 \leq \text{init} < 1.50$
$8.0 \leq \text{Gain} < 32.0$	4	2	$1.0 \leq \text{init} < 4.0$

SENSOR CORE DIGITAL DATA PATH

Test Patterns

The AR0543 supports a number of test patterns to facilitate system debug. Test patterns are enabled using `test_pattern_mode` (R0x0600–1). The test patterns are listed in Table 21.

Table 21. TEST PATTERNS

test_pattern_mode	Description
0	Normal operation: no test pattern
1	Solid color
2	100% color bars
3	Fade-to-gray color bars
4	PN9 link integrity pattern (only on sensors with serial interface)
256	Walking 1 s (10-bit)
257	Walking 1 s (8-bit)

Test patterns 0 – 3 replace pixel data in the output image (the embedded data rows are still present). Test pattern 4 replaces all data in the output image (the embedded data rows are omitted and test pattern data replaces the pixel data).

For all of the test patterns, the AR0543 registers must be set appropriately to control the frame rate and output timing. This includes:

- All clock divisors
- `x_addr_start`
- `x_addr_end`
- `y_addr_start`
- `y_addr_end`
- `frame_length_lines`
- `line_length_pck`
- `x_output_size`

- `y_output_size`

Effect of Data Path Processing on Test Patterns

Test patterns are introduced early in the pixel data path. As a result, they can be affected by pixel processing that occurs within the data path. This includes:

- Noise cancellation
- Black pedestal adjustment
- Lens and color shading correction

These effects can be eliminated by the following register settings:

- `R0x3044–5[10] = 0`
- `R0x30C0–1[0] = 1`
- `R0x30D4–5[15] = 0`
- `R0x31E0–1[0] = 0`
- `R0x3180–1[15] = 0`
- `R0x301A–B[3] = 0` (enable writes to data pedestal)
- `R0x301E–F = 0x0000` (set data pedestal to “0”)
- `R0x3780[15] = 0` (turn off lens/color shading correction)

Solid Color Test Pattern

In this mode, all pixel data is replaced by fixed Bayer pattern test data. The intensity of each pixel is set by its associated test data register (`test_data_red`, `test_data_greenR`, `test_data_blue`, `test_data_greenB`).

100% Color Bars Test Pattern

In this test pattern, shown in Figure 21 on page 30, all pixel data is replaced by a Bayer version of an 8-color, color-bar chart (white, yellow, cyan, green, magenta, red, blue, black). Each bar is 1/8 of the width of the pixel array ($2592/8 = 324$ pixels). The pattern repeats after $8 * 324 = 2592$ pixels.

Each color component of each bar is set to either 0 (fully off) or 0x3FF (fully on for 10-bit data).

The pattern occupies the full height of the output image.

The image size is set by `x_addr_start`, `x_addr_end`, `y_addr_start`, `y_addr_end` and may be affected by the setting of `x_output_size`, `y_output_size`. The color-bar pattern is disconnected from the addressing of the pixel array, and will therefore always start on the first visible pixel, regardless of the value of `x_addr_start`. The number of colors that are visible in the output is dependent upon `x_addr_end - x_addr_start` and the setting of `x_output_size`: the width of each color bar is fixed at 324 pixels.

The effect of setting `horizontal_mirror` in conjunction with this test pattern is that the order in which the colors are

generated is reversed: the black bar appears at the left side of the output image. Any pattern repeat occurs at the right side of the output image regardless of the setting of `horizontal_mirror`. The state of `vertical_flip` has no effect on this test pattern.

The effect of subsampling, binning and scaling of this test pattern is undefined. Test patterns should be analyzed at full resolution only.

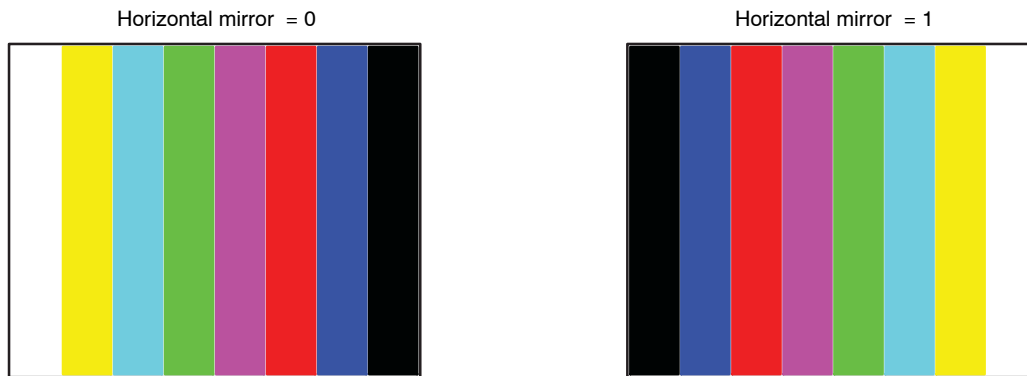

Figure 21. 100 Percent Color Bars Test Pattern

Fade-to-gray Color Bars Test Pattern

In this test pattern, shown in Figure 22 on page 31, all pixel data is replaced by a Bayer version of an 8-color, color-bar chart (white, yellow, cyan, green, magenta, red, blue, black). Each bar is 1/8 of the width of the pixel array ($2592/8 = 324$ pixels). The test pattern repeats after 2592 pixels.

Each color bar fades vertically from zero or full intensity at the top of the image to 50 percent intensity (mid-gray) on the last row of the pattern. Each color bar is divided into a left and a right half, in which the left half fades smoothly and the right half fades in quantized steps.

The speed at which each color fades is dependent on the sensor's data width and the height of the pixel array. We want half of the data range (from 100 or 0 to 50 percent) difference between the top and bottom of the pattern. Because of the Bayer pattern, each state must be held for two rows.

The rate-of-fade of the Bayer pattern is set so that there is at least one full pattern within a full-sized image for the

sensor. Factors that affect this are the resolution of the ADC (10-bit or 12-bit) and the image height.

The image size is set by `x_addr_start`, `x_addr_end`, `y_addr_start`, `y_addr_end` and may be affected by the setting of `x_output_size`, `y_output_size`. The color-bar pattern starts at the first column in the image, regardless of the value of `x_addr_start`. The number of colors that are visible in the output is dependent upon `x_addr_end - x_addr_start` and the setting of `x_output_size`: the width of each color bar is fixed at 324 pixels.

The effect of setting `horizontal_mirror` or `vertical_flip` in conjunction with this test pattern is that the order in which the colors are generated is reversed: the black bar appears at the left side of the output image. Any pattern repeat occurs at the right side of the output image regardless of the setting of `horizontal_mirror`.

The effect of subsampling, binning, and scaling of this test pattern is undefined. T_{ST} patterns should be analyzed at full resolution only.

AR0543

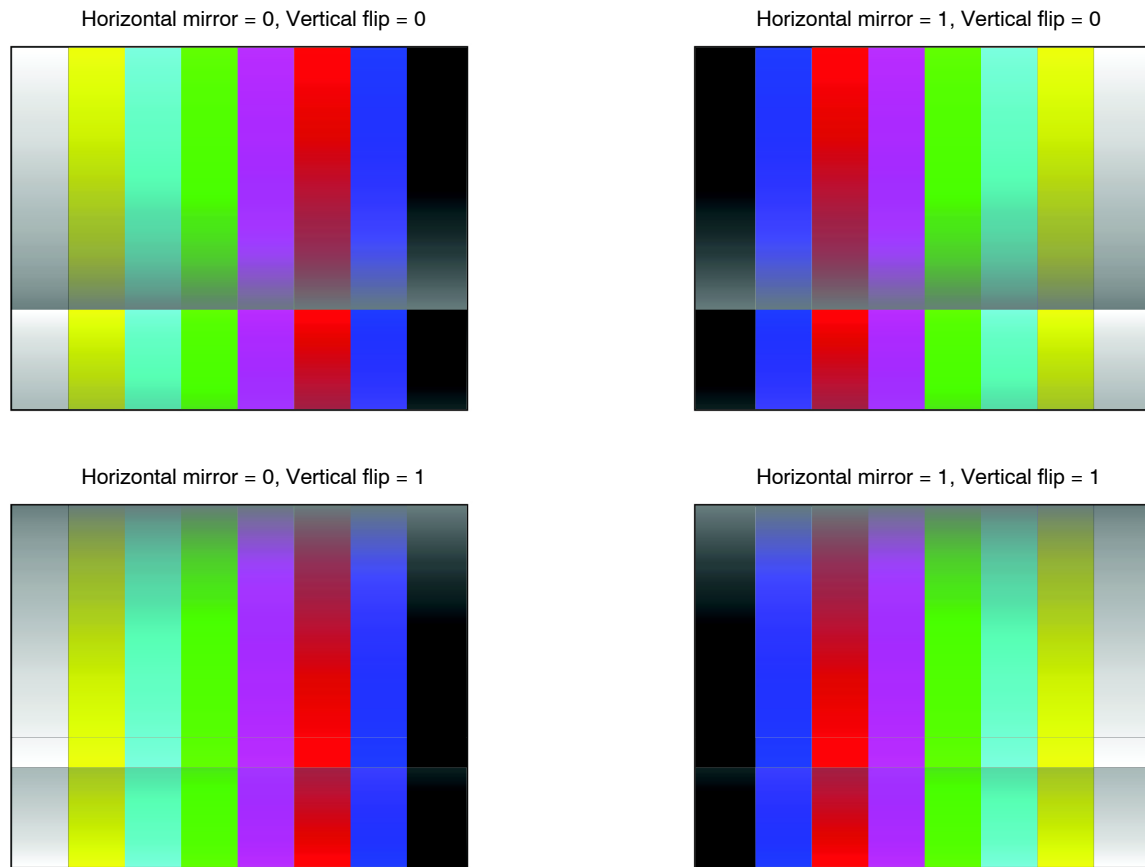

Figure 22. Fade-to-Gray Color Bars Test Pattern

PN9 Link Integrity Pattern

The PN9 link integrity pattern is intended to allow testing of a serial pixel data interface. Unlike the other test patterns, the position of this test pattern at the end of the data path means that it is not affected by other data path corrections (row noise, pixel defect correction and so on).

This test pattern provides a 512-bit pseudo-random test sequence to test the integrity of the serial pixel data output stream. The polynomial $x^9 + x^5 + 1$ is used. The polynomial is initialized to 0x1FF at the start of each frame.

When this test pattern is enabled:

- The embedded data rows are disabled and the value of `frame_format_descriptor_1` changes from 0x1002 to 0x1000 to indicate that no rows of embedded data are present.
- The whole output frame, bounded by the limits programmed in `x_output_size` and `y_output_size`, is filled with data from the PN9 sequence.
- The output data format is (effectively) forced into RAW10 mode regardless of the state of the `ccp_data_format` register.

Before enabling this test pattern the clock divisors must be configured for RAW10 operation (`op_pix_clk_div = 10`).

This polynomial generates this sequence of 10-bit values: 0x1FF, 0x378, 0x1A1, 0x336, 0x385... On the serial pixel data output, these values are streamed out sequentially without performing the RAW10 packing to bytes that normally occurs on this interface.

Test Cursors

The AR0543 supports one horizontal and one vertical cursor, allowing a crosshair to be superimposed on the image or on test patterns 1 – 3. The position and width of each cursor are programmable in registers 0x31E8 – 0x31EE. Both even and odd cursor positions and widths are supported.

Each cursor can be inhibited by setting its width to 0. The programmed cursor position corresponds to the x and y addresses of the pixel array. For example, setting `horizontal_cursor_position` to the same value as `y_addr_start` would result in a horizontal cursor being drawn starting on the first row of the image. The cursors are opaque (they replace data from the imaged scene or test pattern). The color of each cursor is set by the values of the Bayer components in the `test_data_red`, `test_data_greenR`, `test_data_blue` and `test_data_greenB` registers. As a consequence, the cursors are the same color as test pattern 1 and are therefore invisible when test pattern 1 is selected.

When `vertical_cursor_position = 0x0fff`, the vertical cursor operates in an automatic mode in which its position advances every frame. In this mode the cursor starts at the column associated with `x_addr_start = 0` and advances by a step-size of 8 columns each frame, until it reaches the column associated with `x_addr_start = 2584`, after which it wraps (324 steps). The width and color of the cursor in this automatic mode are controlled in the usual way.

The effect of enabling the test cursors when the `image_orientation` register is non-zero is not defined by the design specification. The behavior of the AR0543 is shown in Figure 23 on page 32 and the test cursors are shown as

translucent, for clarity. In practice, they are opaque (they overlay the imaged scene). The manner in which the test cursors are affected by the value of `image_orientation` can be understood from these implementation details:

- The test cursors are inserted last in the data path, the cursor is applied without any sensor corrections.
- The drawing of a cursor starts when the pixel array row or column address is within the address range of cursor start to cursor start + width.
- The cursor is independent of image orientation.

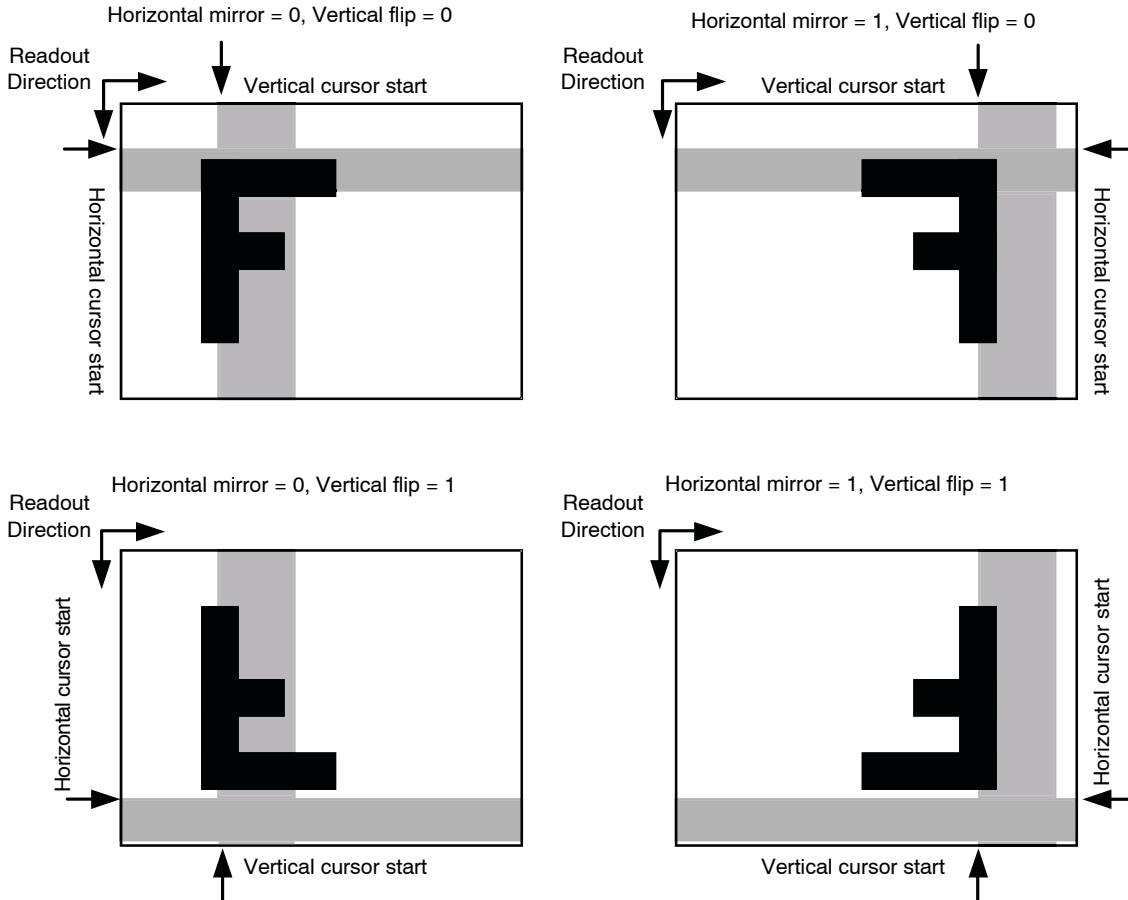

Figure 23. Test Cursor Behavior with `image_orientation`

Digital Gain

Integer digital gains in the range 1 – 7 can be programmed.

Pedestal

This block adds the value from `R0x0008–9` or (`data_pedestal_`) to the incoming pixel value.

The `data_pedestal` register is read-only by default but can be made read/write by clearing the `lock_reg` bit in `R0x301A–B`.

The only way to disable the effect of the pedestal is to set it to 0.

DIGITAL DATA PATH

The digital data path after the sensor core is shown in Figure 24.

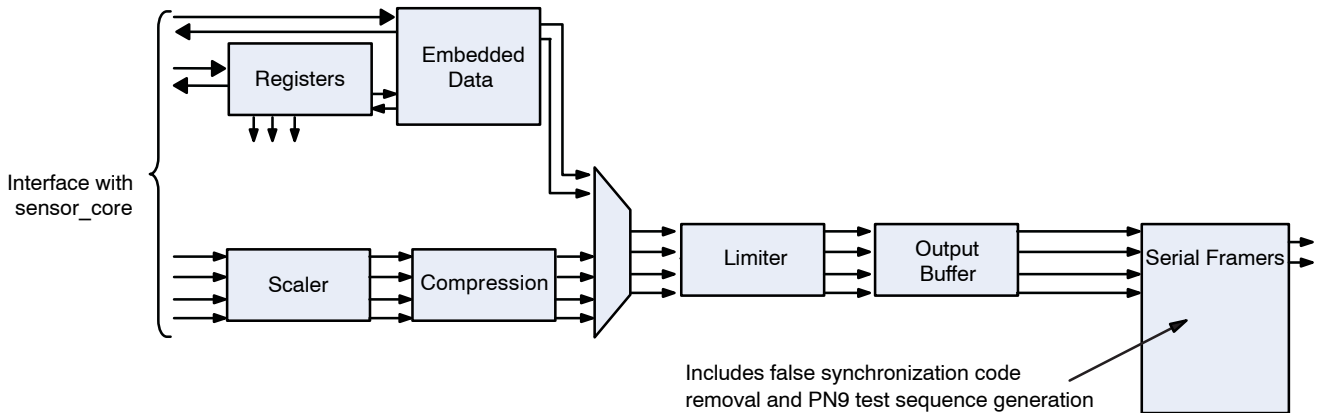

Figure 24. Data Path

Embedded Data Format and Control

When the serial pixel data path is selected, the first two rows of the output image contain register values that are appropriate for the image. The 12-bit format places the data byte in bits [11:4] and sets bits [3:0] to a constant value of 0101. Some register values are dynamic and may change from frame to frame. Additional information on the format of the embedded data can be located in the SMIA specification.

TIMING SPECIFICATIONS

Power-Up Sequence

Two power-up sequences are recommended for the AR0543 based on the XSHUTDOWN and RESET_BAR one-pin (pin-constrained mode) or two-pin (pin-unconstrained mode) control mode.

XSHUTDOWN/RESET_BAR Pin-constrained Mode

1. Turn on V_{DD_IO} power supply.
2. After 0 – 10 ms, Turn on Digital REG_IN (1.8V) power supply.
3. After 0 – 10 ms, enable EXTCLK.
4. After 0 – 100 ms, assert XSHUTDOWN/RESET_BAR (High).
5. After 1 ms – 500 ms, turn on V_{AA}/V_{AA_PIX} power supplies.
6. Wait 1ms for internal initialization into soft standby.
7. Configure PLL, output and image settings to desired values.
8. Set mode_select = 1 (R0x0100).
9. Wait 1 ms for the PLL to lock before streaming state is reached.

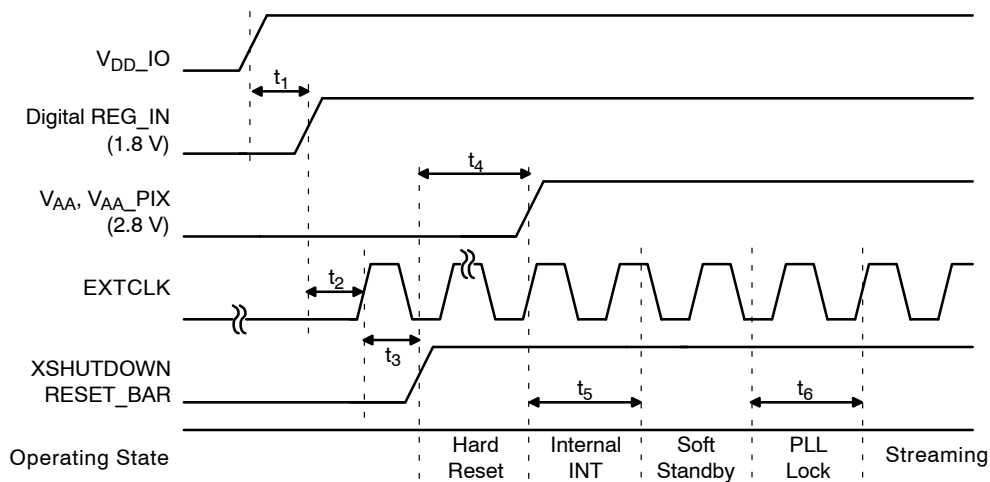

NOTE: If the AR0543 two-wire serial interface is also used for communication with other devices, the status of SDATA during power-up needs to be considered at the system level due to the sensor's interaction during this time (t_0 to t_3) driving it to the low state; if the AR0543 two-wire serial interface is used for a dedicated point-to-point connection to the host, no additional considerations apply

Figure 25. Power-Up Sequence with Pin-constrained Mode

Table 22. POWER-UP SIGNAL TIMING WITH PIN-CONSTRAINED MODE

Parameter	Symbol	Min	Typ	Max	Unit
VDD_IO to Digital REG_IN 1.8 V	t ₁	0	–	10	ms
Digital REG_IN 1.8 V to enable EXTCLK	t ₂	0	–	10	ms
Enable EXTCLK to hard reset assertion	t ₃	0	–	100	ms
Hard reset to V _{AA} /V _{AA_PIX}	t ₄	1	–	500	ms
Internal initialization	t ₅	1	–	–	ms
PLL lock time	t ₆	1	–	–	ms

XSHUTDOWN/RESET_BAR Pin-unconstrained Mode

1. Turn on V_{DD_IO} power supply.
2. After 0 – 10 ms, turn on Digital REG_IN power supply.
3. After 1 – 500 ms, turn on V_{AA}/V_{AA_PIX} power supplies and enable EXTCLK.
4. After 1 ms, assert XSHUTDOWN (High).
5. After 1 ms, assert RESET_BAR (High).
6. Wait 1 ms for internal initialization into soft standby.
7. Configure PLL, output and image settings to desired values.
8. Set mode_select = 1 (R0x0100).
9. Wait 1 ms for the PLL to lock before streaming state is reached.

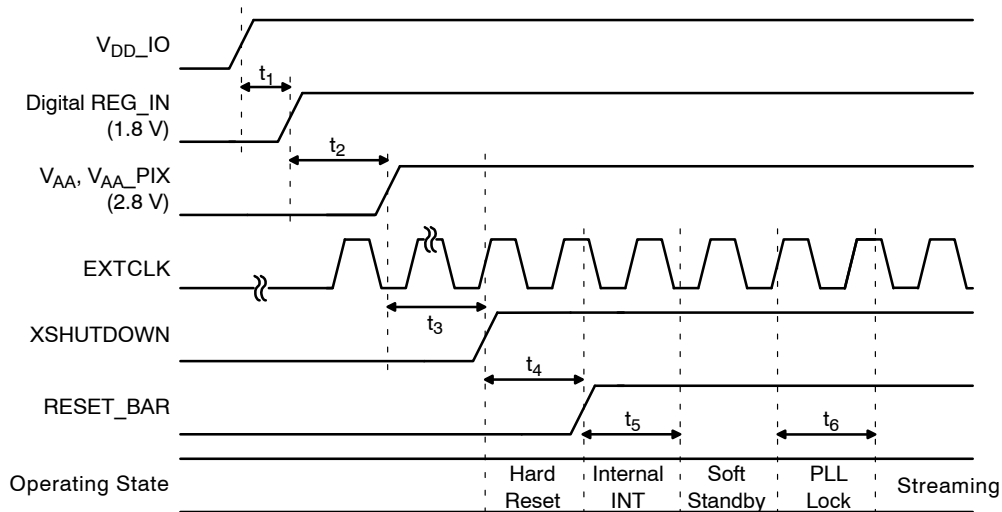

NOTE: If the AR0543 two-wire serial interface is also used for communication with other devices, the status of S_{DATA} during power-up needs to be considered at the system level due to the sensor's interaction during this time (t₀ to t₃) driving it to the low state; if the AR0543 two-wire serial interface is used for a dedicated point-point connection to the host, no additional considerations apply

Figure 26. Power-Up Sequence with Pin-unconstrained Mode

Table 23. POWER-UP SIGNAL TIMING WITH PIN-UNCONSTRAINED MODE

Parameter	Symbol	Min	Typ	Max	Unit
VDD_IO to Digital REG_IN 1.8 V	t ₁	0	–	10	ms
Digital REG_IN (1.8 V) to V _{AA} , V _{AA_PIX} (2.8 V)	t ₂	1	–	500	ms
Running EXTCLK to XSHUTDOWN assertion	t ₃	1	–	–	ms
XSHUTDOWN high to RESET_BAR assertion	t ₄	1	–	–	ms
Internal initialization	t ₅	1	–	–	ms
PLL lock time	t ₆	1	–	–	ms

Power-Down Sequence

The recommended power-down sequence for the AR0543 is shown in Figure 27. The available power supplies—V_{DD_IO}, Digital 1.8 V, V_{AA}, V_{AA_PIX}—can be turned off at the same time or have the separation specified below.

1. Disable streaming if output is active by setting mode_select = 0 (R0x0100).

2. The soft standby state is reached after the current row or frame, depending on configuration, has ended.
3. Assert hard reset by setting XSHUTDOWN/RESET_BAR to a logic “0.”
4. Turn off the V_{AA}/V_{AA_PIX} power supplies.
5. After 0–500 ms, turn off Digital 1.8 V power supply.
6. After 0 – 500 ms, turn off V_{DD_IO} power supply.

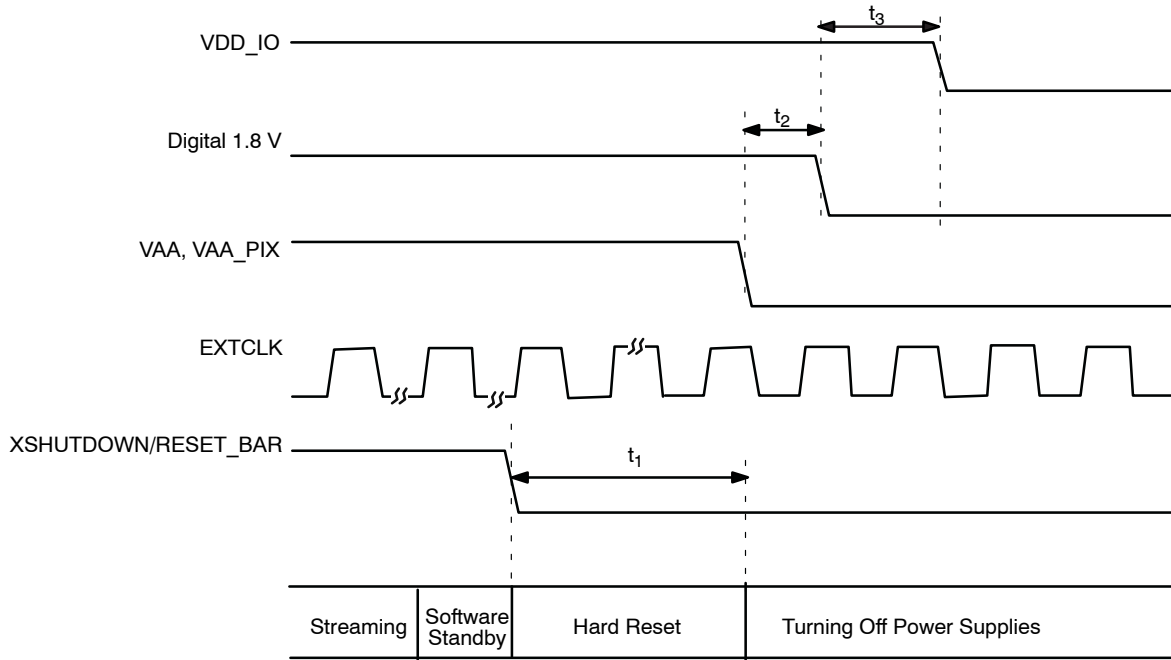

Figure 27. Power-Down Sequence

Table 24. POWER-DOWN SEQUENCE

Parameter	Symbol	Min	Typ	Max	Unit
XSHUTDOWN/RESET_BAR to V _{AA} /V _{AA_PIX}	t ₁	0	–	500	ms
V _{AA} /V _{AA_PIX} to Digital 1.8 V time	t ₂	0	–	500	ms
Digital 1.8 V time to V _{DD_IO}	t ₃	0	–	500	ms

Hard Standby

The hard standby state is reached by the assertion of the XSHUTDOWN pad. There are two hard standby entering and exiting sequences for the AR0543 based on the XSHUTDOWN and RESET_BAR one-pin (pin-constrained mode) or two-pin (pin-unconstrained mode) control mode. Register values are not retained by this action, and will be returned to their default values once the sensor enters the hard standby state. The details of the sequence of the sequence for entering hard standby and exiting from hard standby are described below and shown in Figure 28 and 29.

XSHUTDOWN/RESET_BAR Pin-constrained Mode

< Entering Hard Standby >

1. Disable streaming if output is active by setting mode_select = 0 (R0x0100).

2. The soft standby state is reached after the current row or frame, depending on configuration, has ended.
3. De-assert XSHUTDOWN/RESET_BAR (Low) to enter the hard standby.
4. The sensor remains in hard standby state if XSHUTDOWN/RESET_BAR remains in the logic “0” state.

< Exiting Hard Standby >

1. Turn off V_{AA}/V_{AA_PIX} power-supplies and enable EXTCLK if it was disabled.
2. After 1 ms, assert XSHUTDOWN/RESET/BAR (High).
3. After 1ms, turn on V_{AA}/V_{AA_PIX} power-supplies.
4. Follow the pin-constrained power-up sequence from step 6 to 9 for output streaming.

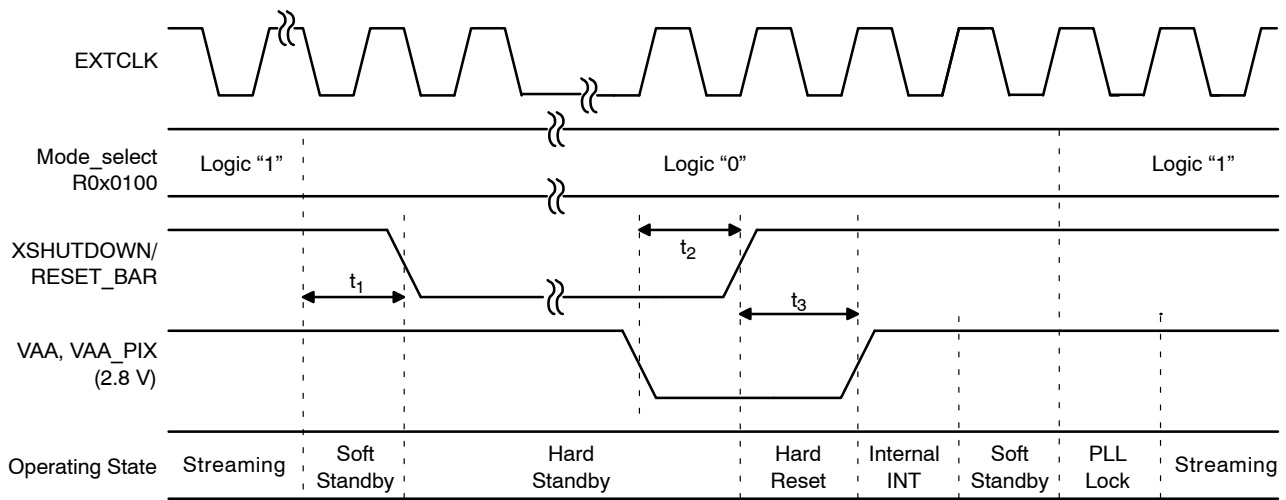

Figure 28. Hard Standby with Pin-constrained Mode

Table 25. HARD STANDBY WITH PIN-CONSTRAINED MODE

Parameter	Symbol	Min	Typ	Max	Unit
Enter soft standby to XSHUTDOWN/RESET_BAR de-assertion	t ₁	1	–	–	ms
Turn off V _{AA} /V _{AA_PIX} to XSHUTDOWN/RESET_BAR assertion	t ₂	1	–	–	ms
XSHUTDOWN assertion to turn on V _{AA} /V _{AA_PIX} supplies	t ₃	1	–	–	ms

XSHUTDOWN/RESET_BAR Pin-unconstrained Mode

< Entering Hard Standby >

5. Disable streaming if output is active by setting mode_select = 0 (R0x0100).
6. The soft standby state is reached after the current row or frame, depending on configuration, has ended.
7. De-assert XSHUTDOWN (Low) to enter the hard standby.
8. The sensor remains in hard standby state if XSHUTDOWN remains in the logic “0” state.

< Exiting Hard Standby >

9. De-assert RESET_BAR (Low) and enable EXTCLK if it was disabled.
10. After 1 ms, assert XSHUTDOWN (High).
11. After 1 ms, assert RESET_BAR (High).
12. Follow the pin-unconstrained power-up sequence from step 6 to 9 for output streaming.

AR0543

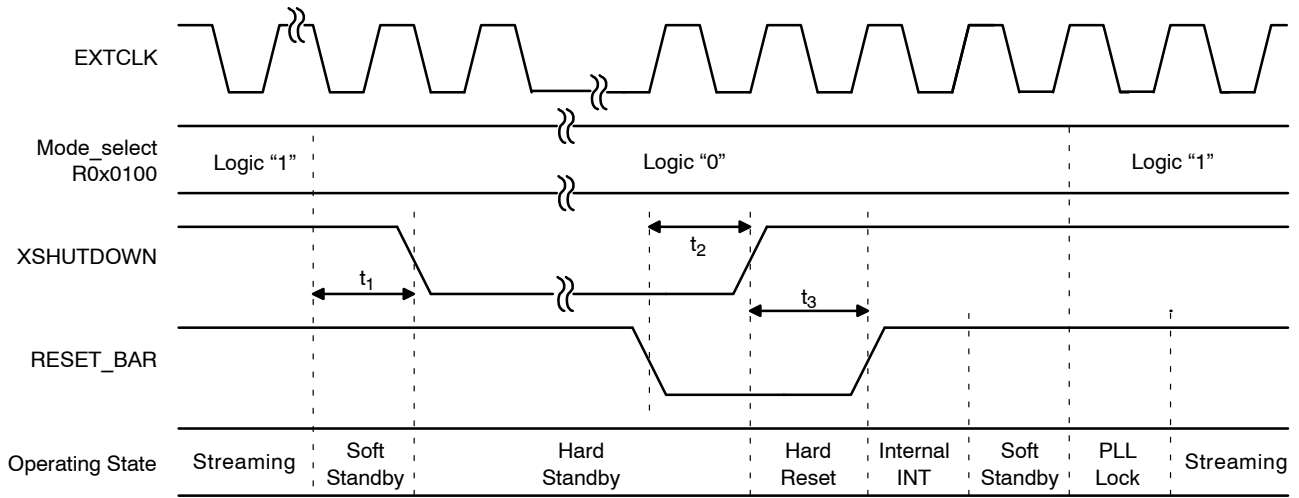

Figure 29. Hard Standby with Pin-unconstrained Mode

Table 26. HARD STANDBY WITH PIN-UNCONSTRAINED MODE

Parameter	Symbol	Min	Typ	Max	Unit
Enter soft standby to XSHUTDOWN de-assertion	t_1	1	–	–	ms
RESET_BAR de-assertion to XSHUTDOWN assertion	t_2	1	–	–	ms
XSHUTDOWN assertion to RESET_BAR assertion	t_3	1	–	–	ms

Soft Standby and Soft Reset

The AR0543 can reduce power consumption by switching to the soft standby state when the output is not needed. Register values are retained in the soft standby state. Once this state is reached, soft reset can be enabled optionally to return all register values to the default. The details of the sequence are described below and shown in Figure 30.

Soft Standby

1. Disable streaming if output is active by setting `mode_select = 0 (R0x0100)`.

2. The soft standby state is reached after the current row or frame, depending on configuration, has ended.

Soft Reset

1. Follow the soft standby sequence list above.
2. 1. Set `software_reset = 1 (R0x0103)` to start the internal initialization sequence.
3. After 2400 EXTCLKs, the internal initialization sequence is completed and the current state returns to soft standby automatically. All registers, including `software_reset`, return to their default values.

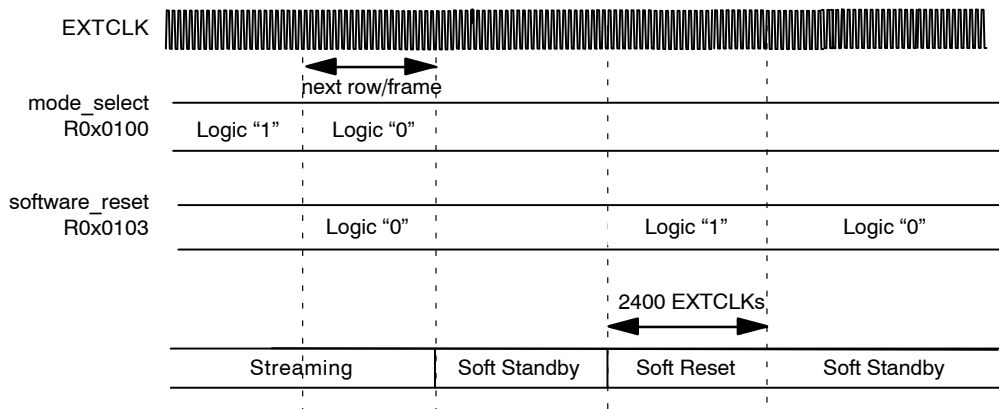

Figure 30. Soft Standby and Soft Reset

SPECTRAL CHARACTERISTICS

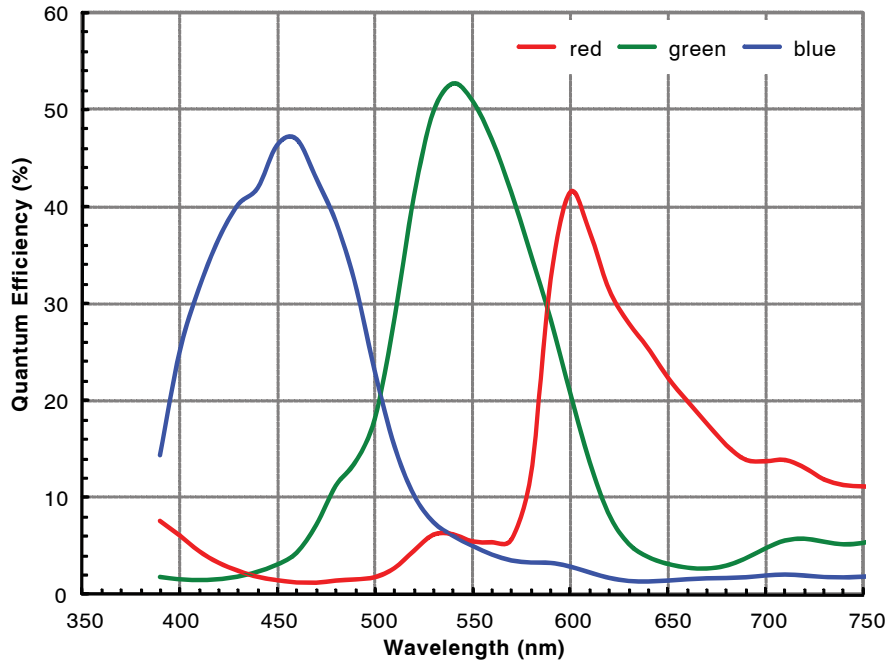

Figure 31. Quantum Efficiency

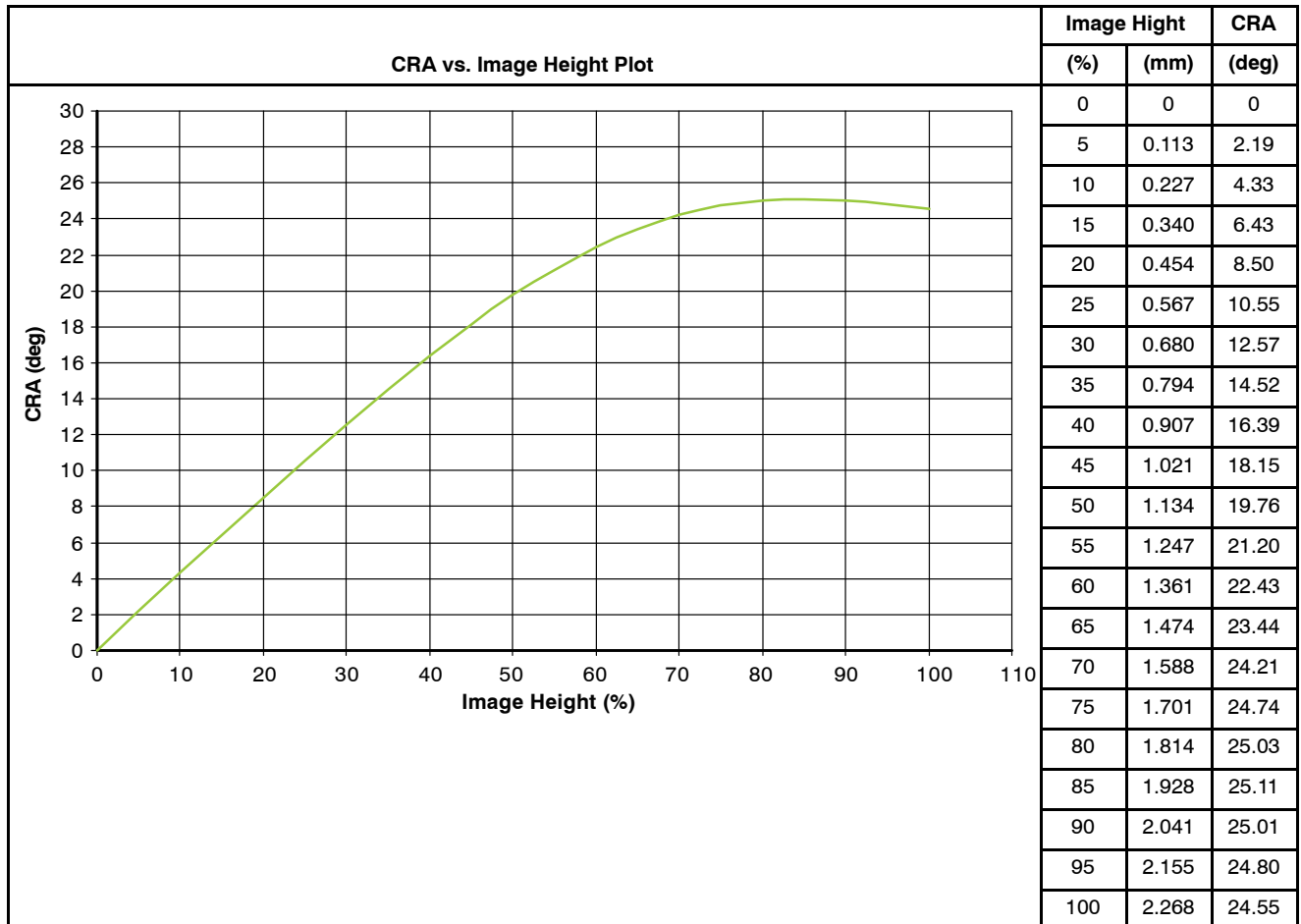

Figure 32. Chief Ray Angle (CRA) vs. Image Height

ELECTRICAL CHARACTERISTICS

Two-Wire Serial Register Interface

The electrical characteristics of the two-wire serial register interface (SCLK, S_{DATA}) are shown in Figure 33 and

Table 27, “[Two-Wire Serial Interface Electrical Characteristics](#)” on page 39. The SCLK and S_{DATA} signals feature fail-safe input protection, Schmitt trigger input, and suppression of input pulses of less than 50 ns.

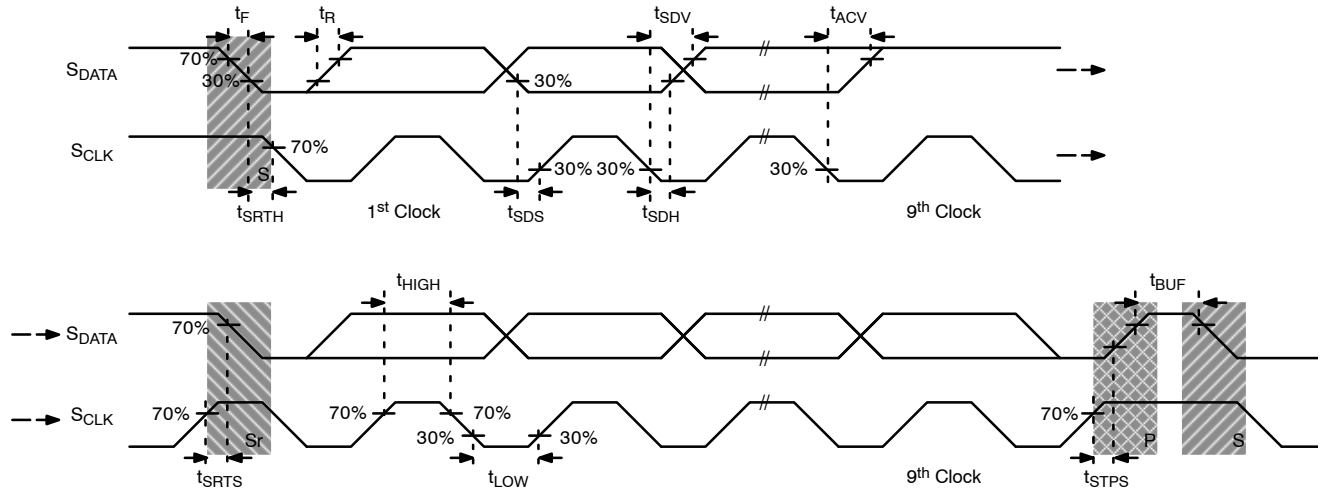

NOTE: Read sequence: For an 8-bit READ, read waveforms start after the WRITE command and register addresses are issued.

Figure 33. Two-Wire Serial Bus Timing Parameters

Table 27. TWO-WIRE SERIAL INTERFACE ELECTRICAL CHARACTERISTICS

(f_{EXTCLK} = 24 MHz; REG_IN = 1.8 V; V_{DD_TX} = 1.8 V; V_{DD_IO} = 1.8 V; V_{AA} = 2.8 V; V_{AA_PIX} = 2.8 V; Output load = 68.5 pF; T_J = 70°C)

Symbol	Parameter	Condition	Min	Typ	Max	Unit
V _{IL}	Input LOW voltage		0.85	0.898	0.96	V
I _{IL}	Input leakage current	No pull up resistor; V _{IN} = V _{DD_IO} or DGND	10	-	14	μA
V _{OL}	Output LOW voltage	At specified 2 mA	0	0.054	0.58	V
I _{OL}	Output LOW current	At specified V _{OL} 0.1 V	-	-	6	mA
C _{IN}	Input pad capacitance		-	-	6	pf
C _{LOAD}	Load capacitance		-	-	N/A	pf

Table 28. TWO-WIRE SERIAL INTERFACE TIMING SPECIFICATION

Symbol	Characteristic	Min	Max	Unit
f _{SCLK}	SCLK frequency	0	400	KHz
t _{HIGH}	SCLK high period	0.6	–	μs
t _{LOW}	SCLK low period	1.3	–	μs
t _{SRTS}	Start setup time	0.6	–	μs
t _{SRTH}	Start hold time	0.6	–	μs
t _{SDS}	Data setup time	100	–	ns
t _{SDH}	Data hold time	0	Note 2	μs
t _{SDV}	Data valid time	–	0.9	μs
t _{ACV}	Data valid acknowledge time	–	0.9	μs
t _{STPS}	Stop setup time	0.6	–	μs
t _{BUF}	Bus free time between STOP and START	1.3	–	μs
t _R	SCLK and SDATA rise time	–	300	ns
t _F	SCLK and SDATA fall time	–	300	ns

2. Maximum t_{SDH} could be 0.9 μs, but must be less than maximum of t_{SDV} and t_{ACV} by a transition time.

EXTCLK

The electrical characteristics of the EXTCLK input are shown in Table 29. The EXTCLK input supports an AC-coupled sine-wave input clock or a DC-coupled square-wave input clock.

If EXTCLK is AC-coupled to the AR0543 and the clock is stopped, the EXTCLK input to the AR0543 must be driven to ground or to V_{DD_IO}. Failure to do this will result in excessive current consumption within the EXTCLK input receiver.

Table 29. ELECTRICAL CHARACTERISTICS (EXTCLK) (f_{EXTCLK} = 24 MHz; f_{PIXCLK} = 84 MHz; REG_IN = 1.8 V; V_{DD_TX} = 1.8 V; V_{DD_IO} = 1.8 V; V_{AA} = 2.8 V; V_{AA_PIX} = 2.8 V; Output load = 68.5 pF; T_J = 70°C)

Symbol	Parameter	Condition	Min	Typ	Max	Unit
f _{EXTCLK1}	Input clock frequency	PLL enabled	6	–	27	MHz
t _{EXTCLK1}	Input clock period	PLL enabled	37	–	167	ns
t _R	Input clock rise slew rate		–	2.9	8*	ns
t _F	Input clock fall slew rate		–	2.7	8*	ns
V _{IN_AC}	Input clock minimum voltage swing (AC coupled)		0.5	–	–	V _{pp}
V _{IN_DC}	Input clock maximum voltage swing (DC coupled)		–	–	2.3	V
f _{CLKMAX(AC)}	Input clock signaling frequency (low amplitude)	V _{IN} = V _{IN_AC} (MIN)	–	–	12	MHz
f _{CLKMAX(DC)}	Input clock signaling frequency (full amplitude)	V _{IN} = V _{DD_IO}	–	–	27	MHz
	Clock duty cycle		35	50	65	%
t _{JITTER}	Input clock jitter	cycle-to-cycle	–	–	600	ps
t _{LOCK}	PLL VCO lock time		–	0.2	1	ms
C _{IN}	Input pad capacitance		–	3	–	pF
I _{IH}	Input HIGH leakage current		1.36	1.89	3	μA
V _{IH}	Input HIGH voltage		1.26	–	2.3	V
V _{IL}	Input LOW voltage		–0.5	–	0.5	V

*Assuming 12 MHz input clock.

Serial Pixel Data Interface

The electrical characteristics of the serial pixel data interface (CLK_P, CLK_N, DATA0_P, DATA1_P, DATA0_N, and DATA1_N) are shown in Table 30 and Table 31.

To operate the serial pixel data interface within the electrical limits of the CSI-2 specification, V_{DD_IO} (I/O digital voltage) is restricted to operate in the range 1.7–1.9 V. All MIPI specifications are with sensor operation using on-chip internal regulator.

Table 30. HS TRANSMITTER DC SPECIFICATIONS

Symbol	Parameter	Min	Nom	Max	Unit	Notes
V_{CMTX}	HS transmit static common-mode voltage	150	200	250	mV	3
$\Delta V_{CMTX(1,0)}$	V_{CMTX} mismatch when output is Differential – 1 or Differential – 0	–	–	5	mV	4
ΔV_{OD}	HS transmit differential voltage	140	200	270	mV	3
ΔV_{OD}	V_{OD} mismatch when output is Differential – 1 or Differential – 0	–	–	10	mV	4
V_{OHHS}	HS output high voltage	–	–	360	mV	3
Z_{OS}	Single ended output impedance	40	50	62.5	W	
$ \Delta Z_{OS} $	Single ended output impedance mismatch	–	–	20	%	

3. Value when driving into load impedance anywhere in the Z_{ID} range.

4. It is recommended that the implementer minimize ΔV_{OD} and $\Delta V_{CMTX(1,0)}$ in order to minimize radiation and optimize signal integrity.

Table 31. HS TRANSMITTER AC SPECIFICATIONS

Symbol	Parameter	Min	Nom	Max	Unit	Notes
$\Delta V_{CMTX(HF)}$	HS transmit static common-mode voltage	–	–	15	mV _{RMS}	
$\Delta V_{CMTX(LF)}$	V_{CMTX} mismatch when output is Differential – 1 or Differential – 0	–	–	25	mV _{PEAK}	
t_R and t_F	20% – 80% rise time and fall time	–	–	0.3	UI	6
		150	–	–	ps	

5. UI is equal to $1/(2*fh)$.

6. Excess capacitance not to exceed 4 pF on each pin.

Table 32. LP TRANSMITTER DC SPECIFICATIONS

Symbol	Parameter	Min	Nom	Max	Unit	Notes
V_{OH}	HS transmit static common-mode voltage	1.1	1.2	1.3	V	
V_{OL}	V_{CMTX} mismatch when output is Differential – 1 or Differential – 0	–50	–	50	mV	
Z_{OLP}	20% – 80% rise time and fall time	110	–	–	Ω	7

7. Though no maximum value for Z_{OLP} is specified, the LP transmitter output impedance shall ensure the T_{RLP}/T_{FLP} is met.

Table 33. LP TRANSMITTER AC SPECIFICATIONS

Symbol	Parameter	Min	Max	Unit	Notes
TRLP/TFLP	15% – 80% rise time and fall time	–	25	ns	8
TREOT	30% – 85% rise time and fall time	–	35	ns	8, 12, 13
$\sigma V/\sigma tSR$	Slew rate @ $C_{LOAD} = 70$ pF (Falling edge only)	–	150	mV/ns	8, 10, 14, 15
	Slew rate @ $C_{LOAD} = 70$ pF (Rising edge only)	–	–	mV/ns	8, 9, 10

8. C_{LOAD} includes the low-frequency equivalent transmission line capacitance. The capacitance of TX and RX are assumed to always be <10 pF. The disturbed line capacitance can up to 50 pF for a transmission line with 2 ns delay.
9. When the output voltage is between 400 mV and 930 mV.
10. Measured as average across any 50 V segment of the output signal transition.
11. This parameter value can be lower than T_{LPX} due to differences in the rise vs. fall signal slopes and trip levels and mismatches between Dp and Dn transmitters. ANY LP transmitters. Any LP exclusive – OR pulse observed during HS EoT (transition from HS level to LP-1) is glitch behavior.
12. The rise time of T_{REOT} starts from the HS common – Level at the moment the differential amplitude drops below 70 mV, due to stopping the differential drive.
13. With an additional load capacitance CCM between 0 and 60 pF on the termination center tap at RX side of the Lane.
14. This value represents a corner point in a piecewise linear curve.
15. When the output voltage is in the range specified by $V_{PIN(absmax)}$
16. When the output voltage is between 400 mV and 700 mV
17. When V_{OINST} is the instantaneous output voltage, V_{DP} or V_{DN} in millivolts.
18. When the output voltage is between 700 mV and 930 mV

High Speed Clock Timing

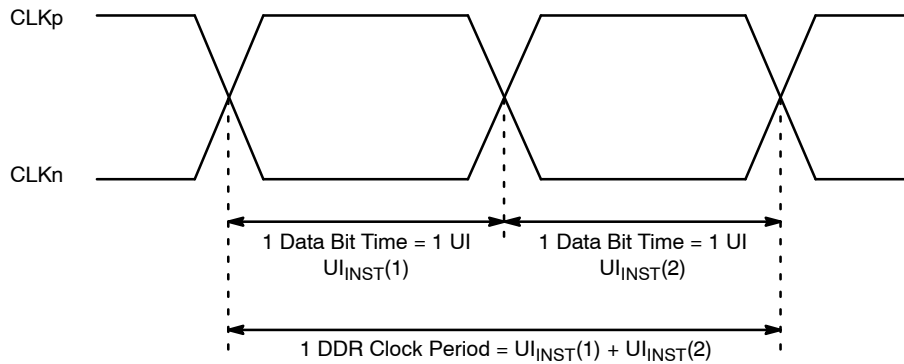

Table 34. DC ELECTRICAL CHARACTERISTICS (CONTROL INTERFACE)

Symbol	Clock Parameter	Min	Typ	Max	Unit	Note
U_{IINST}	UI instantaneous	–	–	12.5	ns	19, 20

19. his value corresponds to a minimum 80 Mbps data rate.
20. The minimum UI shall not be violated for any single bit period, for example any DDR half cycle within a data burst.

Data Clock Timing Specification

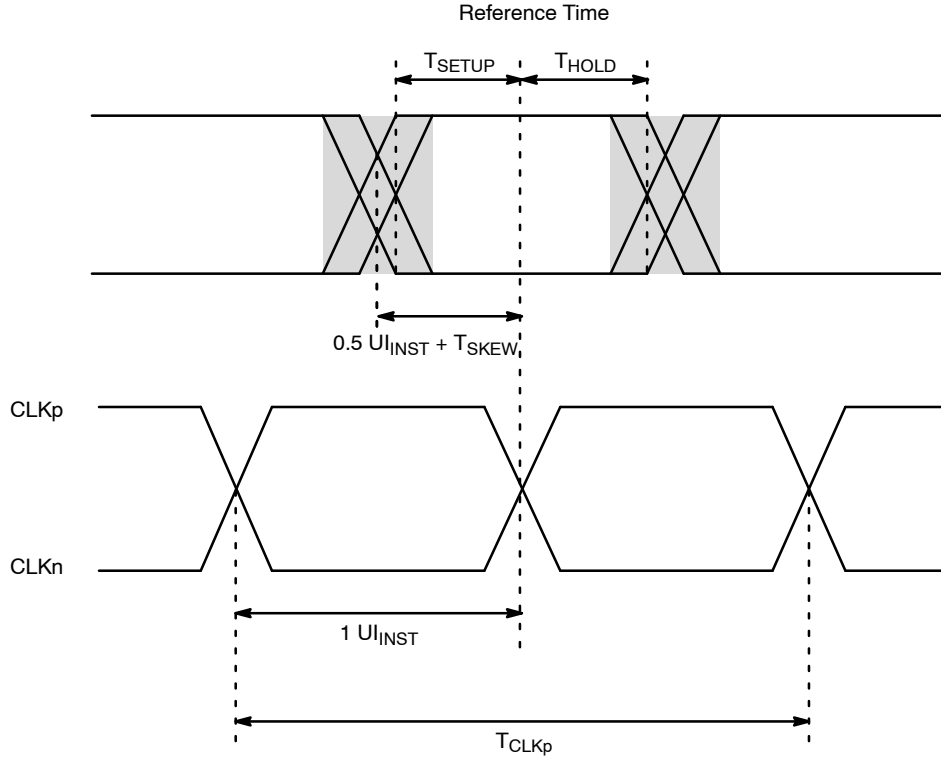

Figure 34. Data Clock Timing

Table 35. DATA-CLOCK TIMING SPECIFICATIONS

Symbol	Clock Parameter	Min	Typ	Max	Unit
$T_{SKEW[TX]}$	Data to Clock Skew (measured at transmitter)	-0.15	-	0.15	U_{I_INST}

21. Total silicon and package delay of $0.3 * U_{I_INST}$.

Control Interfaces

The electrical characteristics of the control interface (RESET_BAR, TEST, GPIO, GPI1, GPI2, and GPI3) are shown in Table 36.

Table 36. DC ELECTRICAL CHARACTERISTICS (CONTROL INTERFACE)

($f_{EXTCLK} = 24$ MHz; $V_{REG_IN} = 1.8$ V; $V_{DD_TX} = 1.8$ V; $V_{DD_IO} = 1.8$ V; $V_{AA} = 2.8$ V; $V_{AA_PIX} = 2.8$ V; Output load = 68.5 pF; $T_J = 70^\circ\text{C}$)

Symbol	Parameter	Condition	Min	Typ	Max	Unit
V_{IH}	Input HIGH voltage		1.26	-	2.3	V
V_{IL}	Input LOW voltage		-0.5	-	0.5	V
I_{IN}	Input leakage current	No pull-up resistor; $V_{IN} = V_{DD_IO}$ or D_{GND}	-	-	10	μA
C_{IN}	Input pad capacitance		-	3	-	pF

AR0543

Operating Voltages

V_{AA} and V_{AA_PIX} must be at the same potential for correct operation of the AR0543.

Table 37. DC ELECTRICAL DEFINITIONS AND CHARACTERISTICS ($f_{EXTCLK} = 24$ MHz; $REG_IN = 1.8$ V; $V_{DD_TX} = 1.8$ V; $V_{DD_IO} = 1.8$ V; $V_{AA} = 2.8$ V; $V_{AA_PIX} = 2.8$ V; Output Load = 68.5 pF; Using Internal Regulator; $T_J = 70^\circ\text{C}$)

Symbol	Parameter	Condition	Min	Typ	Max	Unit
REG_IN	1.8 V supply voltage		1.7	1.8	1.9	
V_{DD_TX}	PHY digital voltage		1.7	1.8	1.9	V
V_{DD_IO}	I/O digital voltage	Pixel data interface	1.7	1.8	1.9	V
			2.4	2.8	3.1	V
V_{AA}	Analog voltage		2.6	2.8	3.1	V
V_{AA_PIX}	Pixel supply voltage		2.6	2.8	3.1	V
I_REGIN/TX	1.8 V digital current	Streaming, full resolution MIPI 15 FPS	24	26.5	44	mA
I_{DD_IO}	I/O digital current		0.007	0.04	0.08	
I_{AA}/I_{AA_PIX}	Analog current		45	60	85	
I_REGIN/TX	1.8 V digital current	Streaming, 1296x972 (xy_bin) resolution MIPI 30 FPS	15	18.5	30	mA
I_{DD_IO}	I/O digital current		0.007	0.03	0.08	
I_{AA}/I_{AA_PIX}	Analog current		50	65	85	
	Hard Standby (Clock on at 24 MHz)	STANDBY current when asserting XSHUTDOWN signal	-	-	-	
	Analog Current		0.3	1	4	μA
	Digital current		1.5	2	6	μA
	Hard Standby (Clock off)		-	-	-	
	Analog Current		0.3	1	4	μA
	Digital current		1.5	2	6	μA
	Soft Standby (Clock on at 24 MHz)	STANDBY current when asserting R0x100 = 1	-	-	-	
	Analog Current		15	41	90	μA
	Digital current		4	4.8	7.5	mA
	Soft Standby (Clock off)		-	-	-	
	Analog Current		15	41	90	μA
	Digital current		3.5	4.2	7	mA

Absolute Maximum Ratings*Caution*

Stresses greater than those listed in Table 38 may cause permanent damage to the device. Exposure to absolute maximum rating conditions for extended periods may affect

reliability. This is a stress rating only, and functional operation of the device at these or any other conditions above those indicated in the operational sections of this specification is not implied.

Table 38. ABSOLUTE MAXIMUM VALUES

Symbol	Parameter	Min	Max	Unit
V _{DD1V8} (REG_IN)	1.8 V digital voltage	-0.3	2.1	V
V _{DD_TX}	PHY digital voltage	-0.3	2.1	V
V _{DD_IO}	I/O digital voltage	-0.3	3.5	V
V _{AA}	Analog supply voltage	-0.3	3.5	V
V _{AA_PIX}	Pixel supply voltage	-0.3	3.5	V
T _{OP}	Operating temperature measured at junction	-30	70	°C
T _{STG}	Storage temperature	-40	85	°C

SMIA and MIPI Specification Reference

The sensor design and this documentation is based on the following reference documents:

- SMIA Specifications:
 - ◆ SMIA 1.0 Part 1: Functional Specification (Version 1.0 dated 30 June 2004)
- MIPI Specifications:
 - ◆ SMIA 1.0 Part 1: Functional Specification ECR0001 (Version 1.0 dated 11 Feb 2005)
 - ◆ MIPI Alliance Standard for CSI-2 version 1.0
 - ◆ MIPI Alliance Specification for D-PHY Version 1.00.00 – 14 May 2009



ODCSP54 5.263x5.072

CASE 570BS

ISSUE A

DATE 21 OCT 2019

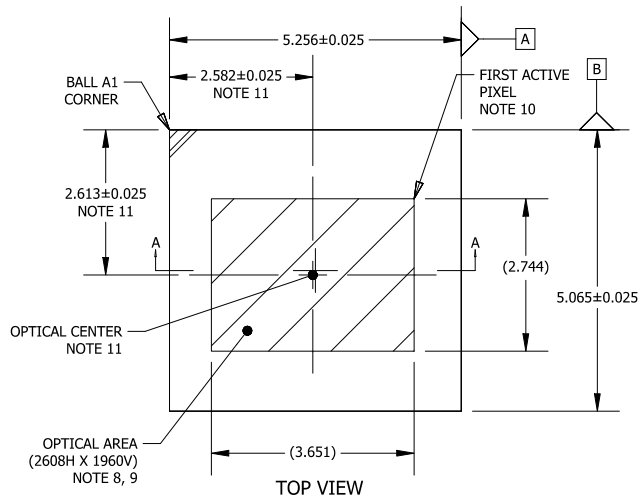

NOTES:

1. DIMENSIONING AND TOLERANCING PER ASME Y14.5M, 1994.
2. CONTROLLING DIMENSION: MILLIMETERS [mm].
3. SOLDER BALL DIAMETER IS MEASURED AT THE MAXIMUM SOLDER BALL DIAMETER PARALLEL TO DATUM C.
4. COPLANARITY APPLIES TO THE SPHERICAL CROWNS OF THE SOLDER BALLS.
5. DATUM C, THE SEATING PLANE IS DEFINED BY THE SPHERICAL CROWNS OF THE SOLDER BALLS.
6. GLASS: 0.400 [mm] THICKNESS; REFRACTIVE INDEX = 1.52.
7. AIR GAP BETWEEN GLASS AND PIXEL ARRAY: 0.041 THICKNESS.
8. PARALLELISM APPLIES ONLY TO THE ACTIVE ARRAY.
9. MAXIMUM ROTATION OF ACTIVE ARRAY RELATIVE TO DATUMS A AND B IS ±0.1°.
10. REFER TO THE DEVICE DATA SHEET FOR TOTAL PIXEL ARRAY DEFINITIONS.
11. OPTICAL CENTER RELATIVE TO PACKAGE CENTER (X, Y) = (-0.047, -0.080).
12. PACKAGE CENTER (X, Y) = (0.000, 0.000).

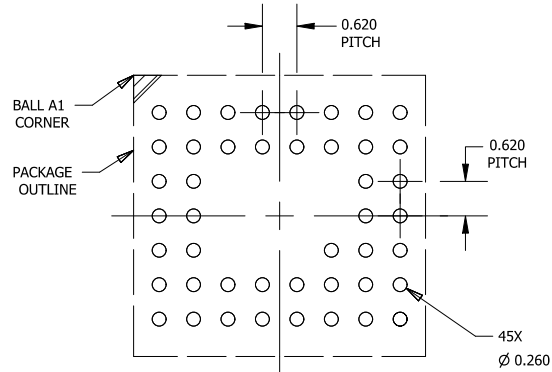
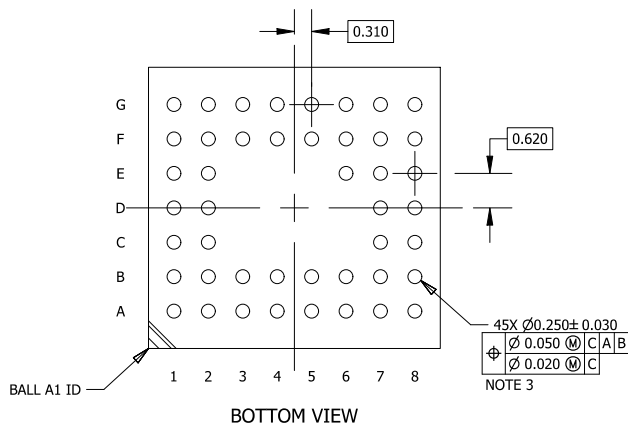
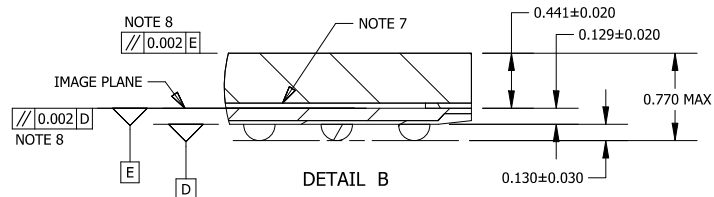
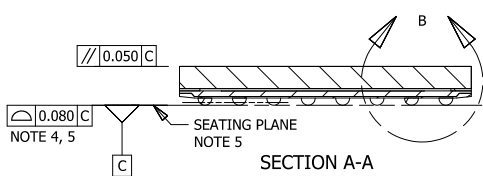

RECOMMENDED MOUNTING FOOTPRINT*
 *FOR ADDITIONAL INFORMATION ON OUR Pb-FREE STRATEGY AND SOLDERING DETAILS, PLEASE DOWNLOAD THE ON SEMICONDUCTOR SOLDERING AND MOUNTING TECHNIQUES REFERENCE MANUAL, SOLDERRM/D.

DOCUMENT NUMBER:	98AON96413F	Electronic versions are uncontrolled except when accessed directly from the Document Repository. Printed versions are uncontrolled except when stamped "CONTROLLED COPY" in red.
DESCRIPTION:	ODCSP54 5.263x5.072	PAGE 1 OF 1

ON Semiconductor and ON are trademarks of Semiconductor Components Industries, LLC dba ON Semiconductor or its subsidiaries in the United States and/or other countries. ON Semiconductor reserves the right to make changes without further notice to any products herein. ON Semiconductor makes no warranty, representation or guarantee regarding the suitability of its products for any particular purpose, nor does ON Semiconductor assume any liability arising out of the application or use of any product or circuit, and specifically disclaims any and all liability, including without limitation special, consequential or incidental damages. ON Semiconductor does not convey any license under its patent rights nor the rights of others.

onsemi, **Onsemi**, and other names, marks, and brands are registered and/or common law trademarks of Semiconductor Components Industries, LLC dba "**onsemi**" or its affiliates and/or subsidiaries in the United States and/or other countries. **onsemi** owns the rights to a number of patents, trademarks, copyrights, trade secrets, and other intellectual property. A listing of **onsemi**'s product/patent coverage may be accessed at www.onsemi.com/site/pdf/Patent-Marking.pdf. **onsemi** reserves the right to make changes at any time to any products or information herein, without notice. The information herein is provided "as-is" and **onsemi** makes no warranty, representation or guarantee regarding the accuracy of the information, product features, availability, functionality, or suitability of its products for any particular purpose, nor does **onsemi** assume any liability arising out of the application or use of any product or circuit, and specifically disclaims any and all liability, including without limitation special, consequential or incidental damages. Buyer is responsible for its products and applications using **onsemi** products, including compliance with all laws, regulations and safety requirements or standards, regardless of any support or applications information provided by **onsemi**. "Typical" parameters which may be provided in **onsemi** data sheets and/or specifications can and do vary in different applications and actual performance may vary over time. All operating parameters, including "Typicals" must be validated for each customer application by customer's technical experts. **onsemi** does not convey any license under any of its intellectual property rights nor the rights of others. **onsemi** products are not designed, intended, or authorized for use as a critical component in life support systems or any FDA Class 3 medical devices or medical devices with a same or similar classification in a foreign jurisdiction or any devices intended for implantation in the human body. Should Buyer purchase or use **onsemi** products for any such unintended or unauthorized application, Buyer shall indemnify and hold **onsemi** and its officers, employees, subsidiaries, affiliates, and distributors harmless against all claims, costs, damages, and expenses, and reasonable attorney fees arising out of, directly or indirectly, any claim of personal injury or death associated with such unintended or unauthorized use, even if such claim alleges that **onsemi** was negligent regarding the design or manufacture of the part. **onsemi** is an Equal Opportunity/Affirmative Action Employer. This literature is subject to all applicable copyright laws and is not for resale in any manner.

ADDITIONAL INFORMATION

TECHNICAL PUBLICATIONS:

Technical Library: www.onsemi.com/design/resources/technical-documentation
onsemi Website: www.onsemi.com

ONLINE SUPPORT: www.onsemi.com/support

For additional information, please contact your local Sales Representative at www.onsemi.com/support/sales

