

CSPEMI202FCTAG

2 Channel Headset Microphone EMI Filter with ESD Protection

Product Description

The CSPEMI202FCTAG is a dual low-pass filter array integrating two pi-style filters (C-R-C) that reduce EMI/RFI emissions while at the same time providing ESD protection. This part is custom-designed to interface with a microphone port on a cellular telephone or similar device. Each high quality filter provides more than 35 dB attenuation in the 800–2700 MHz range. These pi-style filters support bidirectional filtering, controlling EMI both to and from a microphone element. They also support bipolar signals, enabling audio signals to pass through without distortion.

In addition, the CSPEMI202AG provides a very high level of protection for sensitive electronic components that may be subjected to electrostatic discharge (ESD). The diodes safely dissipate ESD strikes of ± 8 kV, the maximum requirement of the IEC 61000-4-2 international standard. Using the MIL-STD-883 (Method 3015) specification for Human Body Model (HBM) ESD, the device provides protection for contact discharges to greater than ± 15 kV.

The CSPEMI202FCTAG is particularly well-suited for portable electronics (e.g. cellular telephones, PDAs, notebook computers) because of its small package format and low weight. The CSPEMI202FCTAG is available in a space-saving, low-profile Chip Scale Package with RoHS compliant lead-free finishing.

Features

- Two Channels of EMI Filtering
- Pi-Style EMI Filters in a Capacitor-Resistor-Capacitor (C-R-C) Network
- Greater than 40 dB Attenuation at 1 GHz
- ± 8 kV ESD Protection on each Channel (IEC 61000-4-2 Level 4, Contact Discharge)
- ± 15 kV ESD Protection on each Channel (HBM)
- Supports Bipolar Signals – Ideal for Audio Applications
- Chip Scale Package Features Extremely Low Lead Inductance for Optimum Filter and ESD Performance
- 5-Bump, 0.930 x 1.410 mm Footprint Chip Scale Package (CSP)
- These Devices are Pb-Free and are RoHS Compliant

Applications

- EMI Filtering and ESD Protection for Headset Microphone Ports
- Wireless Handsets
- Handheld PCs / PDAs
- MP3 Players
- Digital Camcorders
- Notebooks
- Desktop PCs



ON Semiconductor®

www.onsemi.com



WLCSP5
AG SUFFIX
CASE 567LT

ELECTRICAL SCHEMATIC

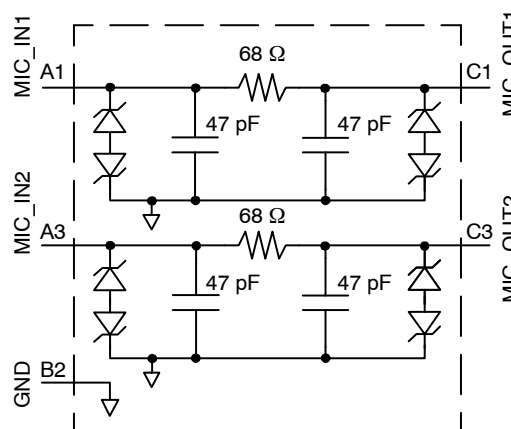

MARKING DIAGRAM



AE = CSPEMI202FC

ORDERING INFORMATION

| Device | Package | Shipping [†] |
|----------------|--------------------|-----------------------|
| CSPEMI202FCTAG | CSP-5 (Pb-Free) | 3500 / Tape & Reel |

[†]For information on tape and reel specifications, including part orientation and tape sizes, please refer to our Tape and Reel Packaging Specification Brochure, BRD8011/D.

CSPEMI202FCTAG

Table 1. PIN DESCRIPTIONS

| 5-bump CSP Package | | |
|--------------------|----------|--|
| Pin | Name | Description |
| A1 | MIC_IN1 | Microphone Input 1 (from microphone) |
| A3 | MIC_IN2 | Microphone Input 2 (from microphone) |
| B2 | GND | Device Ground |
| C1 | MIC_OUT1 | Microphone Output 1 (to audio circuitry) |
| C3 | MIC_OUT2 | Microphone Output 2 (to audio circuitry) |

PACKAGE / PINOUT DIAGRAMS

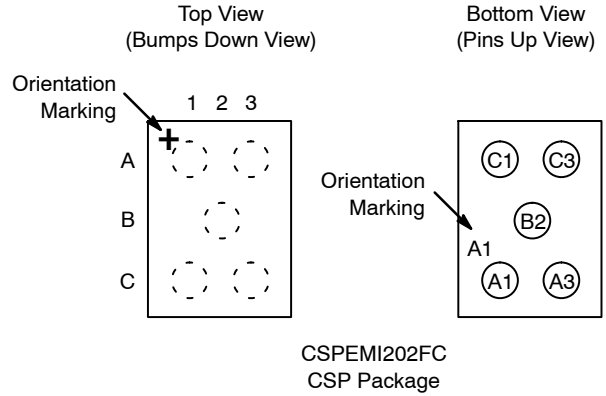

SPECIFICATIONS

Table 2. ABSOLUTE MAXIMUM RATINGS

| Parameter | Rating | Units |
|---------------------------|-------------|-------|
| Storage Temperature Range | -65 to +150 | °C |
| DC Power per Resistor | 100 | mW |
| DC Package Power Rating | 200 | mW |

Stresses exceeding those listed in the Maximum Ratings table may damage the device. If any of these limits are exceeded, device functionality should not be assumed, damage may occur and reliability may be affected.

Table 3. STANDARD OPERATING CONDITIONS

| Parameter | Rating | Units |
|-----------------------------|------------|-------|
| Operating Temperature Range | -40 to +85 | °C |

Table 4. ELECTRICAL OPERATING CHARACTERISTICS (Note 1)

| Symbol | Parameter | Conditions | Min | Typ | Max | Units |
|------------|--|---------------------------|---------------------|------------|----------|---------------|
| R_1 | Resistance | | 61 | 68 | 75 | Ω |
| C_1 | Channel Capacitance | | 76 | 94 | 112 | pF |
| I_{LEAK} | Diode Leakage Current | $V_{IN} = 5.0\text{ V}$ | | | 1.0 | μA |
| V_{SIG} | Signal Voltage Positive Clamp Negative Clamp | $I_{LOAD} = 10\text{ mA}$ | 5 -15 | 7 -10 | 15 -5 | V |
| V_{ESD} | In-system ESD Withstand Voltage a) Human Body Model, MIL-STD-883, Method 3015 b) Contact Discharge per IEC 61000-4-2 Level 4 | (Note 2) | ± 15 ± 8 | | | kV |
| V_{CL} | Clamping Voltage during ESD Discharge MIL-STD-883 (Method 3015), 8 kV Positive Transients Negative Transients | (Notes 2 and 3) | | +15 -19 | | V |
| f_C | Cut-off frequency $Z_{SOURCE} = 50\ \Omega$, $Z_{LOAD} = 50\ \Omega$ | | | 60 | | MHz |

Product parametric performance is indicated in the Electrical Characteristics for the listed test conditions, unless otherwise noted. Product performance may not be indicated by the Electrical Characteristics if operated under different conditions.

- $T_A = 25^\circ\text{C}$ unless otherwise specified.
- ESD applied to input and output pins with respect to GND, one at a time.
- Clamping voltage is measured at the opposite side of the EMI filter to the ESD pin. For example, if ESD is applied to Pin A1, then clamping voltage is measured at Pin C1.

CSPEMI202FCTAG

PERFORMANCE INFORMATION

Typical Filter Performance (nominal conditions unless specified otherwise, 50 Ω Environment)

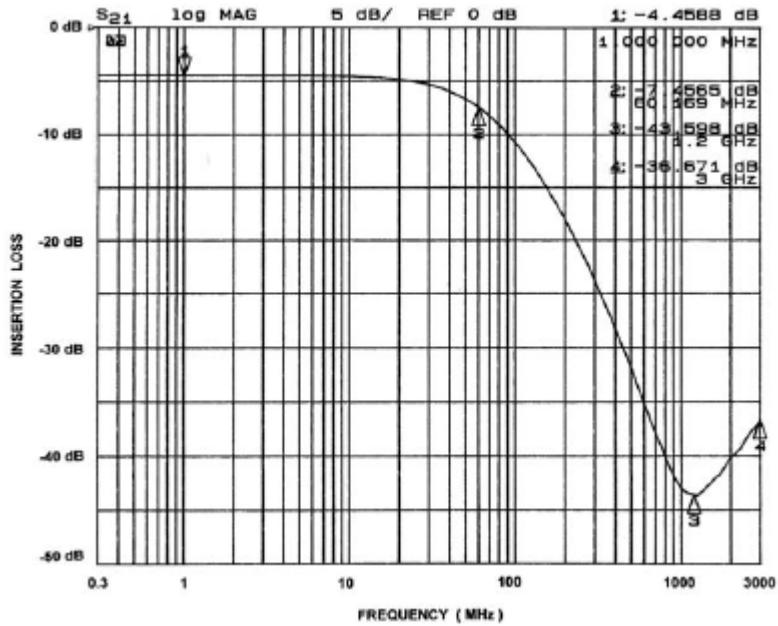

Figure 1. Insertion Loss vs. Frequency (A1-C1 to GND B2)

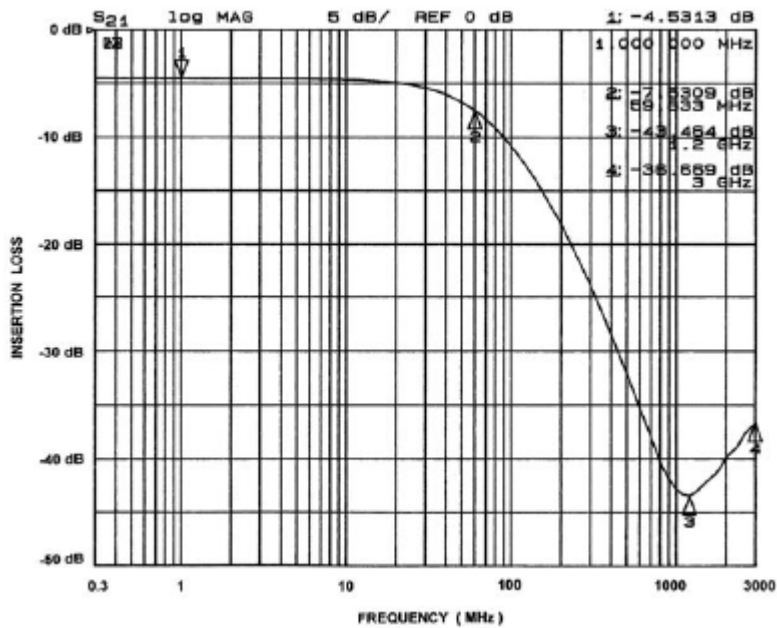

Figure 2. Insertion Loss vs. Frequency (A3-C3 to GND B2)

CSPEMI202FCTAG

APPLICATION INFORMATION

| Parameter | Value |
|--|------------------------------|
| Pad Size on PCB | 0.240 mm |
| Pad Shape | Round |
| Pad Definition | Non-Solder Mask defined pads |
| Solder Mask Opening | 0.290 mm Round |
| Solder Stencil Thickness | 0.125 mm – 0.150 mm |
| Solder Stencil Aperture Opening (laser cut, 5% tapered walls) | 0.300 mm Round |
| Solder Flux Ratio | 50/50 by volume |
| Solder Paste Type | No Clean |
| Pad Protective Finish | OSP (Entek Cu Plus 106A) |
| Tolerance – Edge To Corner Ball | ±50 µm |
| Solder Ball Side Coplanarity | ±20 µm |
| Maximum Dwell Time Above Liquidous | 60 seconds |
| Maximum Soldering Temperature for Lead-free Devices using a Lead-free Solder Paste | 260°C |

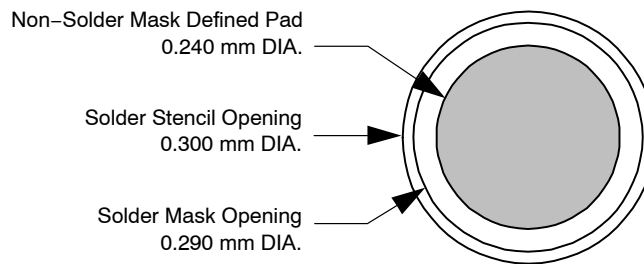

Figure 3. Recommended Non-Solder Mask Defined Pad Illustration

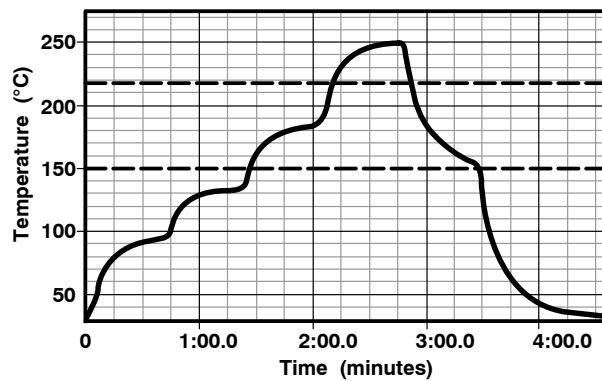

Figure 4. Lead-free (SnAgCu) Solder Ball Reflow Profile

MECHANICAL CASE OUTLINE

PACKAGE DIMENSIONS

ON Semiconductor®



SCALE 4:1

WLCSP5, 1.41x0.94
CASE 567LT
ISSUE O

DATE 05 JUN 2015

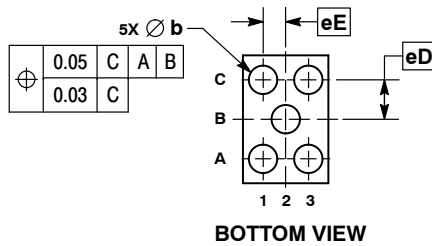
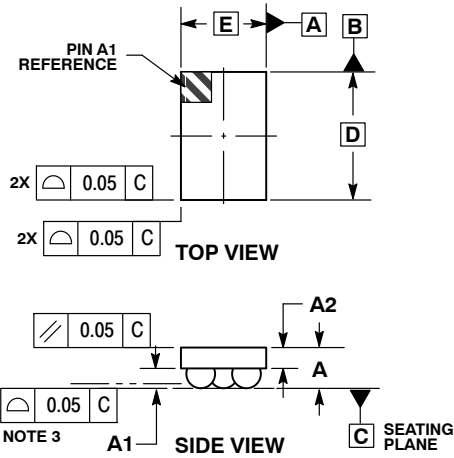

NOTES:

1. DIMENSIONING AND TOLERANCING PER ASME Y14.5M, 1994.
2. CONTROLLING DIMENSION: MILLIMETERS.
3. COPLANARITY APPLIES TO SPHERICAL CROWNS OF SOLDER BALLS.

| DIM | MILLIMETERS | |
|-----|-------------|------|
| | MIN | MAX |
| A | 0.40 | 0.50 |
| A1 | 0.21 | 0.27 |
| A2 | 0.23 | REF |
| b | 0.29 | 0.35 |
| D | 1.41 | BSC |
| E | 0.94 | BSC |
| eD | 0.435 | BSC |
| eE | 0.25 | BSC |

GENERIC MARKING DIAGRAM*



- X = Specific Device Code
- M = Month Code

*This information is generic. Please refer to device data sheet for actual part marking. Pb-Free indicator, "G" or microdot "▪", may or may not be present.

RECOMMENDED SOLDERING FOOTPRINT*

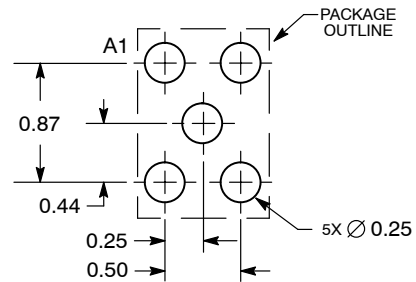

DIMENSIONS: MILLIMETERS

*For additional information on our Pb-Free strategy and soldering details, please download the ON Semiconductor Soldering and Mounting Techniques Reference Manual, SOLDERRM/D.

| | | |
|-------------------------|--------------------------|--|
| DOCUMENT NUMBER: | 98AON98954F | Electronic versions are uncontrolled except when accessed directly from the Document Repository. Printed versions are uncontrolled except when stamped "CONTROLLED COPY" in red. |
| DESCRIPTION: | WLCSP5, 1.41X0.94 | PAGE 1 OF 1 |

ON Semiconductor and are trademarks of Semiconductor Components Industries, LLC dba ON Semiconductor or its subsidiaries in the United States and/or other countries. ON Semiconductor reserves the right to make changes without further notice to any products herein. ON Semiconductor makes no warranty, representation or guarantee regarding the suitability of its products for any particular purpose, nor does ON Semiconductor assume any liability arising out of the application or use of any product or circuit, and specifically disclaims any and all liability, including without limitation special, consequential or incidental damages. ON Semiconductor does not convey any license under its patent rights nor the rights of others.

onsemi, **Onsemi**, and other names, marks, and brands are registered and/or common law trademarks of Semiconductor Components Industries, LLC dba "**onsemi**" or its affiliates and/or subsidiaries in the United States and/or other countries. **onsemi** owns the rights to a number of patents, trademarks, copyrights, trade secrets, and other intellectual property. A listing of **onsemi**'s product/patent coverage may be accessed at www.onsemi.com/site/pdf/Patent-Marking.pdf. **onsemi** reserves the right to make changes at any time to any products or information herein, without notice. The information herein is provided "as-is" and **onsemi** makes no warranty, representation or guarantee regarding the accuracy of the information, product features, availability, functionality, or suitability of its products for any particular purpose, nor does **onsemi** assume any liability arising out of the application or use of any product or circuit, and specifically disclaims any and all liability, including without limitation special, consequential or incidental damages. Buyer is responsible for its products and applications using **onsemi** products, including compliance with all laws, regulations and safety requirements or standards, regardless of any support or applications information provided by **onsemi**. "Typical" parameters which may be provided in **onsemi** data sheets and/or specifications can and do vary in different applications and actual performance may vary over time. All operating parameters, including "Typicals" must be validated for each customer application by customer's technical experts. **onsemi** does not convey any license under any of its intellectual property rights nor the rights of others. **onsemi** products are not designed, intended, or authorized for use as a critical component in life support systems or any FDA Class 3 medical devices or medical devices with a same or similar classification in a foreign jurisdiction or any devices intended for implantation in the human body. Should Buyer purchase or use **onsemi** products for any such unintended or unauthorized application, Buyer shall indemnify and hold **onsemi** and its officers, employees, subsidiaries, affiliates, and distributors harmless against all claims, costs, damages, and expenses, and reasonable attorney fees arising out of, directly or indirectly, any claim of personal injury or death associated with such unintended or unauthorized use, even if such claim alleges that **onsemi** was negligent regarding the design or manufacture of the part. **onsemi** is an Equal Opportunity/Affirmative Action Employer. This literature is subject to all applicable copyright laws and is not for resale in any manner.

ADDITIONAL INFORMATION

TECHNICAL PUBLICATIONS:

Technical Library: www.onsemi.com/design/resources/technical-documentation
onsemi Website: www.onsemi.com

ONLINE SUPPORT: www.onsemi.com/support

For additional information, please contact your local Sales Representative at www.onsemi.com/support/sales

