

# Schottky Power Rectifier, Switch-Mode, 10 A, 45 V

## MBRB1045G, MBRD1045G, SBRB1045G, SBRD81045T4G

This series of Power Rectifiers employs the Schottky Barrier principle in a large metal-to-silicon power diode. State-of-the-art geometry features epitaxial construction with oxide passivation and metal overlay contact. Ideally suited for use in low voltage, high frequency switching power supplies, free wheeling diodes, and polarity protection diodes.

### Features

- Guardring for Stress Protection
- Low Forward Voltage
- 175°C Operating Junction Temperature
- Epoxy Meets UL 94 V-0 @ 0.125 in
- Short Heat Sink Tab Manufactured – Not Sheared!
- SBRB and SBRD8 Prefixes for Automotive and Other Applications Requiring Unique Site and Control Change Requirements; AEC-Q101 Qualified and PPAP Capable
- These Devices are Pb-Free, Halogen Free/BFR Free and are RoHS Compliant

### Mechanical Characteristics:

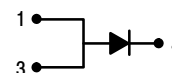
- Case: Epoxy, Molded, Epoxy Meets UL 94 V-0
- Weight: 1.7 grams for D<sup>2</sup>PAK (approximately)  
0.4 grams for DPAK (approximately)
- Finish: All External Surfaces Corrosion Resistant and Terminal Leads are Readily Solderable
- Lead and Mounting Surface Temperature for Soldering Purposes: 260°C Max. for 10 Seconds
- Device Meets MSL1 Requirements
- ESD Ratings:
  - ◆ Machine Model = C (> 400 V)
  - ◆ Human Body Model = 3B (> 8000 V)



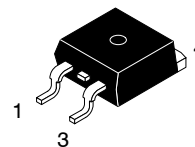
ON Semiconductor®

[www.onsemi.com](http://www.onsemi.com)

## SCHOTTKY BARRIER RECTIFIER 10 AMPERES, 45 VOLTS



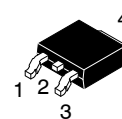
### MARKING DIAGRAM



D<sup>2</sup>PAK-3  
CASE 418B

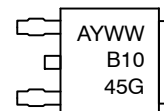


A = Assembly Location  
Y = Year  
WW = Work Week  
MBRB1045 = Device Code  
G = Pb-Free Package  
AKA = Diode Polarity



DPAK  
CASE 369C

### MARKING DIAGRAM



A = Assembly Location  
Y = Year  
WW = Work Week  
B1045 = Device Code  
G = Pb-Free Package

### ORDERING INFORMATION

See detailed ordering and shipping information in the package dimensions section on page 2 of this data sheet.

# MBRB1045G, MBRD1045G, SBRB1045G, SBRD81045T4G

## MAXIMUM RATINGS

| Rating   | Symbol                          | Value                                   | Unit                   |
|--|---------------------------------|---|------------------------|
| Peak Repetitive Reverse Voltage<br>Working Peak Reverse Voltage<br>DC Blocking Voltage                     | $V_{RRM}$<br>$V_{RWM}$<br>$V_R$ | 45                                      | V                      |
| Average Rectified Forward Current, $T_C = 135^\circ\text{C}$   | $I_{F(AV)}$                     | 10                                      | A                      |
| Peak Repetitive Forward Current<br>(Square Wave, Duty = 0.5) $T_C = 135^\circ\text{C}$                     | $I_{FRM}$                       | 20                                      | A                      |
| Nonrepetitive Peak Surge Current<br>(Surge applied at rated load conditions halfwave, single phase, 60 Hz) | $I_{FSM}$                       | 150<br>(MBRB/SBRB)<br>70<br>(MBRD/SBRD) | A                      |
| Operating Junction and Storage Temperature Range (Note 1)  | $T_J, T_{stg}$                  | -65 to +175                             | $^\circ\text{C}$       |
| Voltage Rate of Change (Rated $V_R$ )  | $dv/dt$                         | 10000                                   | $\text{V}/\mu\text{s}$ |

Stresses exceeding those listed in the Maximum Ratings table may damage the device. If any of these limits are exceeded, device functionality should not be assumed, damage may occur and reliability may be affected.

1. The heat generated must be less than the thermal conductivity from Junction-to-Ambient:  $dP_D/dT_J < 1/R_{\theta JA}$ .

## THERMAL CHARACTERISTICS

| Characteristic  | Symbol                             | Value      | Unit                      |
|---|------------------------------------|------------|---------------------------|
| Thermal Resistance,<br>(MBRB1045G)<br>Junction-to-Case (Note 2)<br>Junction-to-Ambient (Note 2) | $R_{\theta JC}$<br>$R_{\theta JA}$ | 1.0<br>50  | $^\circ\text{C}/\text{W}$ |
| (MBRD1045G)<br>Junction-to-Case (Note 2)<br>Junction-to-Ambient (Note 2)                        | $R_{\theta JC}$<br>$R_{\theta JA}$ | 2.43<br>68 |                           |

2. When mounted using minimum recommended pad size on FR-4 board.

## ELECTRICAL CHARACTERISTICS

| Characteristic  | Symbol | Value                | Unit |
|---|--------|----------------------|------|
| Maximum Instantaneous Forward Voltage (Note 3)<br>( $I_F = 10$ Amps, $T_J = 125^\circ\text{C}$ )<br>( $I_F = 20$ Amps, $T_J = 125^\circ\text{C}$ )<br>( $I_F = 20$ Amps, $T_J = 25^\circ\text{C}$ ) | $V_F$  | 0.57<br>0.72<br>0.84 | V    |
| Maximum Instantaneous Reverse Current (Note 3)<br>(Rated dc Voltage, $T_J = 125^\circ\text{C}$ )<br>(Rated dc Voltage, $T_J = 25^\circ\text{C}$ )   | $I_R$  | 15<br>0.1            | mA   |

Product parametric performance is indicated in the Electrical Characteristics for the listed test conditions, unless otherwise noted. Product performance may not be indicated by the Electrical Characteristics if operated under different conditions.

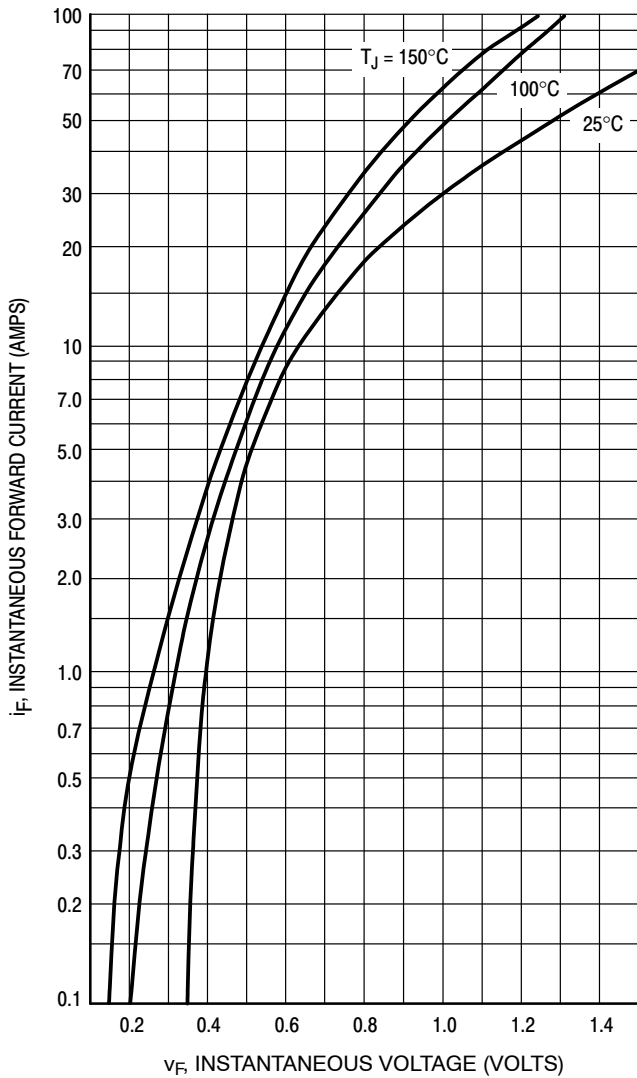
3. Pulse Test: Pulse Width = 300  $\mu\text{s}$ , Duty Cycle  $\leq 2.0\%$

## ORDERING INFORMATION

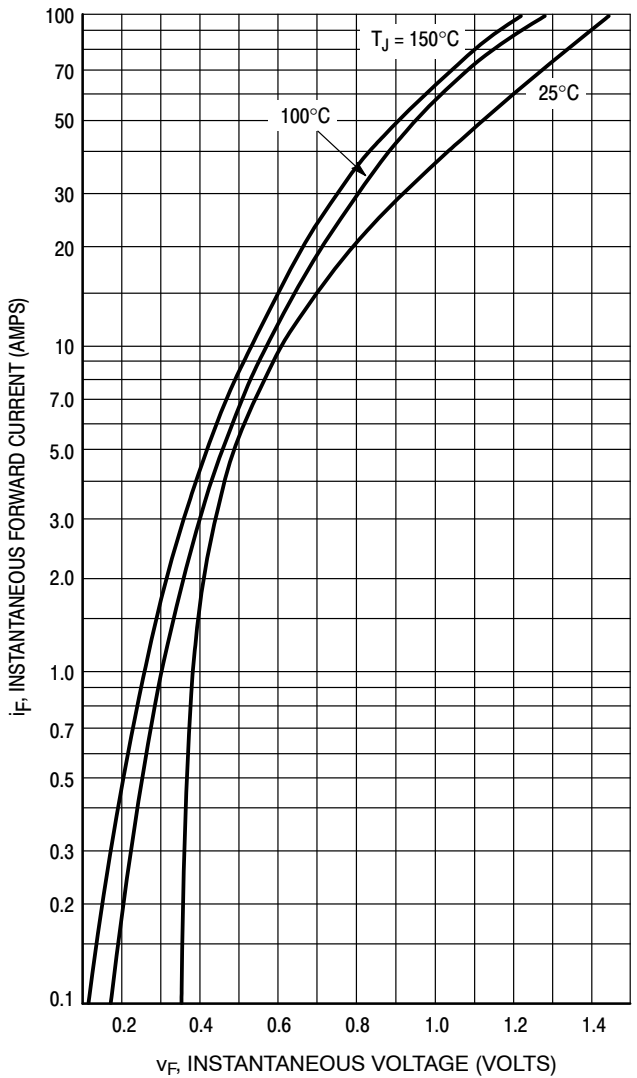
| Device        | Package                           | Shipping†                 |
|---------------|-----------------------------------|---------------------------|
| MBRB1045G     | D <sup>2</sup> PAK-3<br>(Pb-Free) | 50 Units / Rail           |
| SBRB1045G     |                                   | 50 Units / Rail           |
| MBRB1045T4G   |                                   | 800 Units / Tape & Reel   |
| SBRB1045T4G   |                                   | 800 Units / Tape & Reel   |
| MBRD1045G     | DPAK<br>(Pb-Free)                 | 50 Units / Rail           |
| MBRD1045T4G   |                                   | 2,500 Units / Tape & Reel |
| SBRD81045T4G  |                                   | 2,500 Units / Tape & Reel |
| SSBRD81045T4G |                                   | 2,500 Units / Tape & Reel |

†For information on tape and reel specifications, including part orientation and tape sizes, please refer to our Tape and Reel Packaging Specifications Brochure, BRD8011/D.

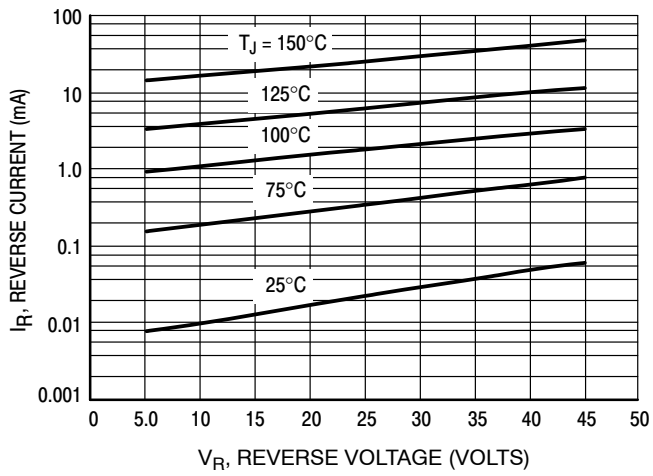
**MBRB1045G, MBRD1045G, SBRB1045G, SBRD81045T4G**



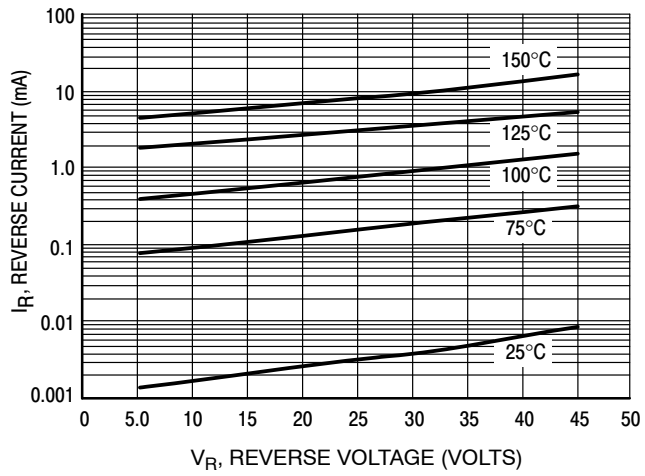
**Figure 1. Maximum Forward Voltage**



**Figure 2. Typical Forward Voltage**

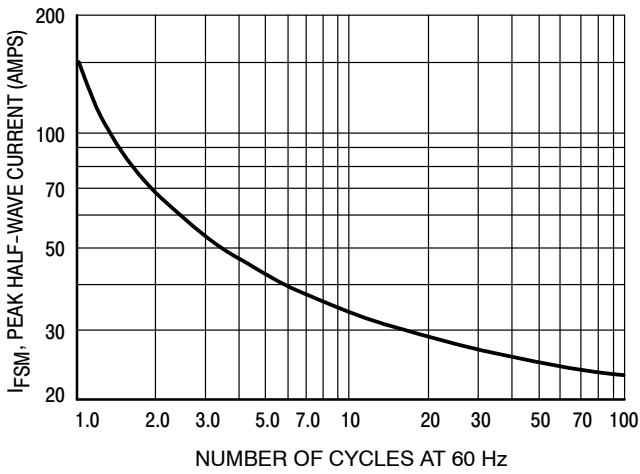


**Figure 3. Maximum Reverse Current**

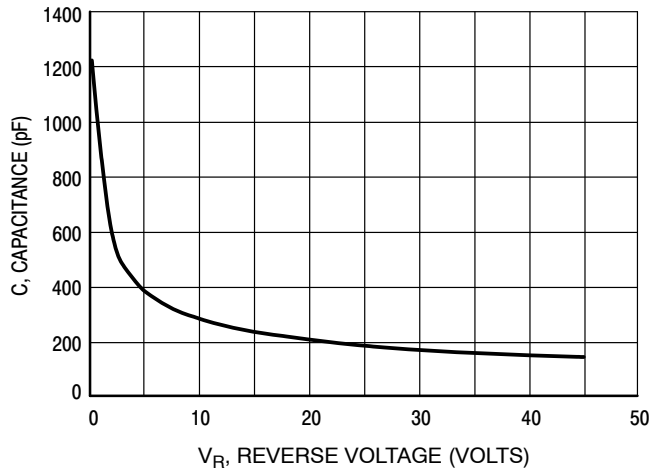


**Figure 4. Typical Reverse Current**

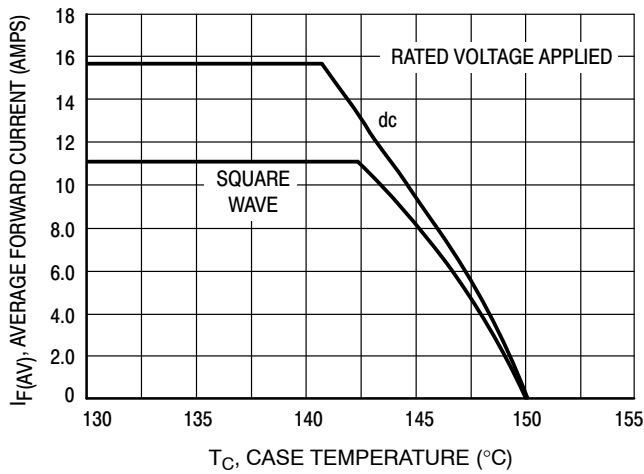
**MBRB1045G, MBRD1045G, SBRB1045G, SBRD81045T4G**



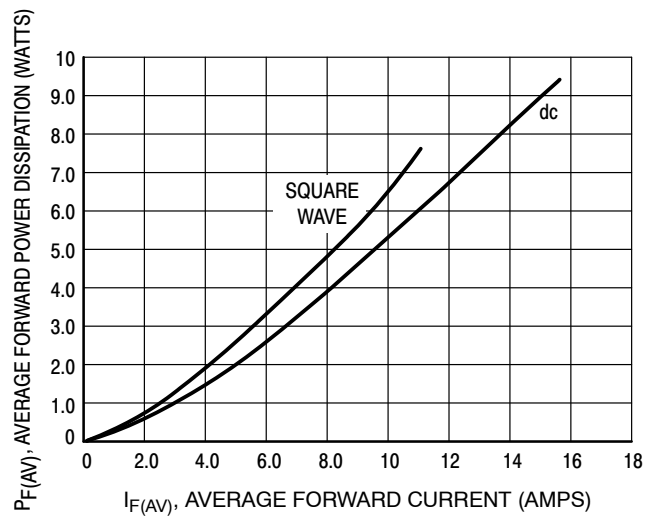
**Figure 8. Maximum Surge Capability**



**Figure 5. Typical Capacitance**

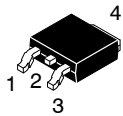


**Figure 6. Current Derating, Case,  
 $R_{\theta JC} = 1.0 \text{ } ^\circ\text{C/W}$**



**Figure 7. Forward Power Dissipation**

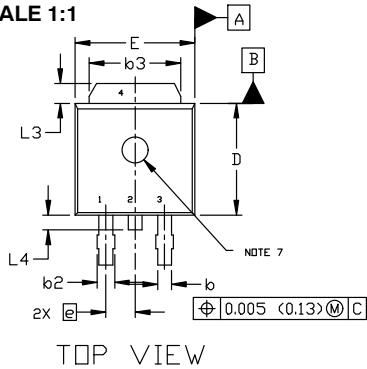
# MECHANICAL CASE OUTLINE PACKAGE DIMENSIONS



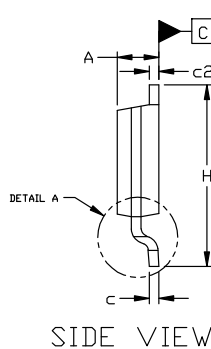
## DPAK (SINGLE GAUGE) CASE 369C ISSUE G

DATE 31 MAY 2023

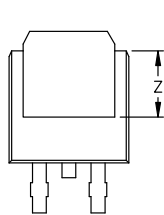
SCALE 1:1



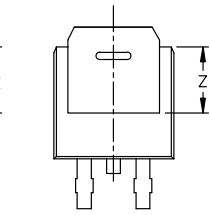
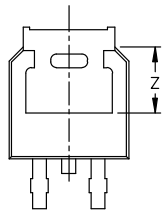
TOP VIEW



SIDE VIEW

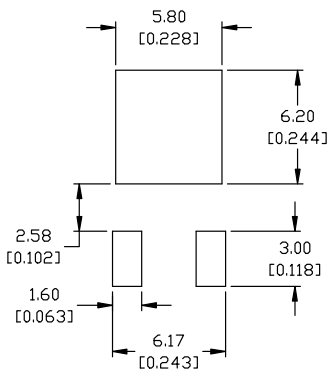


BOTTOM VIEW



BOTTOM VIEW

ALTERNATE CONSTRUCTIONS



### RECOMMENDED MOUNTING FOOTPRINT\*

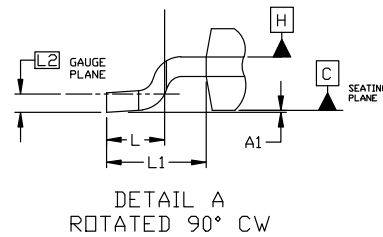
\*FOR ADDITIONAL INFORMATION ON OUR Pb-FREE STRATEGY AND SOLDERING DETAILS, PLEASE DOWNLOAD THE ON SEMICONDUCTOR SOLDERING AND MOUNTING TECHNIQUES REFERENCE MANUAL, SOLDERRM/D.

- |  |  |   |   |  |
|--|--|---|---|--|
| <b>STYLE 1:</b><br>PIN 1. BASE<br>2. COLLECTOR<br>3. EMITTER<br>4. COLLECTOR | <b>STYLE 2:</b><br>PIN 1. GATE<br>2. DRAIN<br>3. SOURCE<br>4. DRAIN          | <b>STYLE 3:</b><br>PIN 1. ANODE<br>2. CATHODE<br>3. ANODE<br>4. CATHODE | <b>STYLE 4:</b><br>PIN 1. CATHODE<br>2. ANODE<br>3. GATE<br>4. ANODE              | <b>STYLE 5:</b><br>PIN 1. GATE<br>2. ANODE<br>3. CATHODE<br>4. ANODE     |
| <b>STYLE 6:</b><br>PIN 1. MT1<br>2. MT2<br>3. GATE<br>4. MT2                 | <b>STYLE 7:</b><br>PIN 1. GATE<br>2. COLLECTOR<br>3. EMITTER<br>4. COLLECTOR | <b>STYLE 8:</b><br>PIN 1. N/C<br>2. CATHODE<br>3. ANODE<br>4. CATHODE   | <b>STYLE 9:</b><br>PIN 1. ANODE<br>2. CATHODE<br>3. RESISTOR ADJUST<br>4. CATHODE | <b>STYLE 10:</b><br>PIN 1. CATHODE<br>2. ANODE<br>3. CATHODE<br>4. ANODE |

### NOTES:

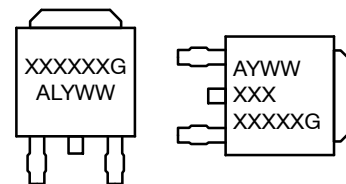
- DIMENSIONING AND TOLERANCING ASME Y14.5M, 1994.
- CONTROLLING DIMENSION: INCHES
- THERMAL PAD CONTOUR OPTIONAL WITHIN DIMENSIONS b3, L3, AND Z.
- DIMENSIONS D AND E DO NOT INCLUDE MOLD FLASH, PROTRUSIONS, OR BURRS. MOLD FLASH, PROTRUSIONS, OR GATE BURRS SHALL NOT EXCEED 0.006 INCHES PER SIDE.
- DIMENSIONS D AND E ARE DETERMINED AT THE OUTERMOST EXTREMES OF THE PLASTIC BODY.
- DATUMS A AND B ARE DETERMINED AT DATUM PLANE H.
- OPTIONAL MOLD FEATURE.

| DIM | INCHES |       | MILLIMETERS |       |
|-----|--------|-------|-------------|-------|
|     | MIN.   | MAX.  | MIN.        | MAX.  |
| A   | 0.086  | 0.094 | 2.18        | 2.38  |
| A1  | 0.000  | 0.005 | 0.00        | 0.13  |
| b   | 0.025  | 0.035 | 0.63        | 0.89  |
| b2  | 0.028  | 0.045 | 0.72        | 1.14  |
| b3  | 0.180  | 0.215 | 4.57        | 5.46  |
| c   | 0.018  | 0.024 | 0.46        | 0.61  |
| c2  | 0.018  | 0.024 | 0.46        | 0.61  |
| D   | 0.235  | 0.245 | 5.97        | 6.22  |
| E   | 0.250  | 0.265 | 6.35        | 6.73  |
| e   | 0.090  | BSC   | 2.29        | BSC   |
| H   | 0.370  | 0.410 | 9.40        | 10.41 |
| L   | 0.055  | 0.070 | 1.40        | 1.78  |
| L1  | 0.114  | REF   | 2.90        | REF   |
| L2  | 0.020  | BSC   | 0.51        | BSC   |
| L3  | 0.035  | 0.050 | 0.89        | 1.27  |
| L4  | ----   | 0.040 | ---         | 1.01  |
| Z   | 0.155  | ----  | 3.93        | ---   |



DETAIL A  
ROTATED 90° CW

### GENERIC MARKING DIAGRAM\*



- IC**  
 XXXXXX = Device Code  
 A = Assembly Location  
 L = Wafer Lot  
 Y = Year  
 WW = Work Week  
 G = Pb-Free Package
- Discrete**  
 AYWW  
 XXX  
 XXXXXG

\*This information is generic. Please refer to device data sheet for actual part marking. Pb-Free indicator, "G" or microdot "•", may or may not be present. Some products may not follow the Generic Marking.

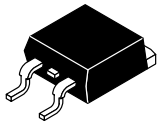
|                         |                            |   |
|-------------------------|----------------------------|---|
| <b>DOCUMENT NUMBER:</b> | <b>98AON10527D</b>         | Electronic versions are uncontrolled except when accessed directly from the Document Repository.<br>Printed versions are uncontrolled except when stamped "CONTROLLED COPY" in red. |
| <b>DESCRIPTION:</b>     | <b>DPAK (SINGLE GAUGE)</b> | <b>PAGE 1 OF 1</b>  |

onsemi and onsemi are trademarks of Semiconductor Components Industries, LLC dba onsemi or its subsidiaries in the United States and/or other countries. onsemi reserves the right to make changes without further notice to any products herein. onsemi makes no warranty, representation or guarantee regarding the suitability of its products for any particular purpose, nor does onsemi assume any liability arising out of the application or use of any product or circuit, and specifically disclaims any and all liability, including without limitation special, consequential or incidental damages. onsemi does not convey any license under its patent rights nor the rights of others.

# MECHANICAL CASE OUTLINE

## PACKAGE DIMENSIONS

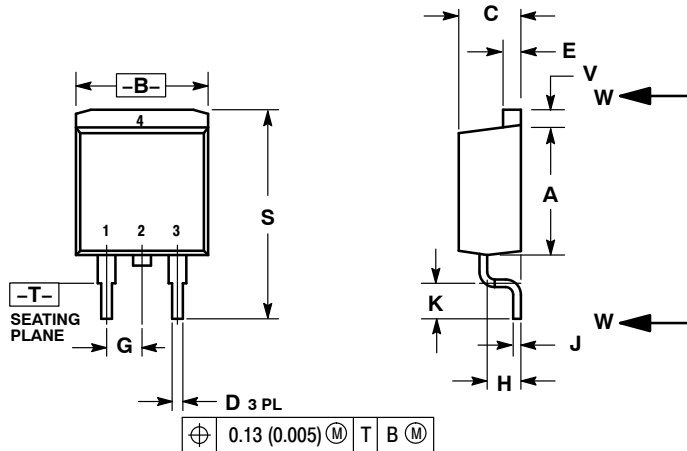
ON Semiconductor®



**D<sup>2</sup>PAK 3**  
CASE 418B-04  
ISSUE L

DATE 17 FEB 2015

SCALE 1:1

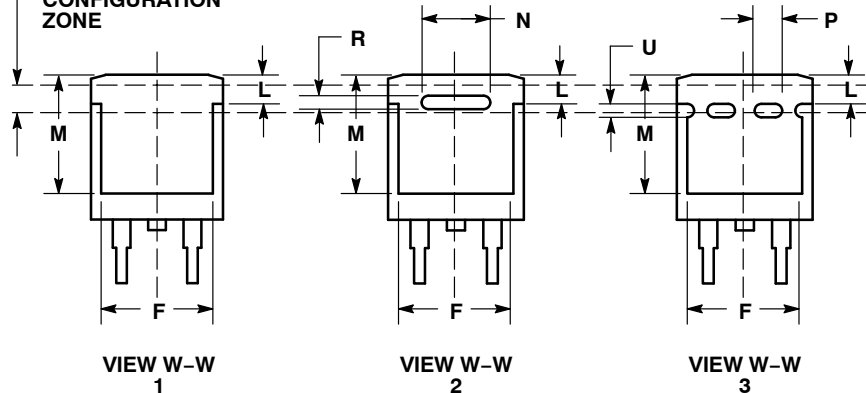


**NOTES:**

1. DIMENSIONING AND TOLERANCING PER ANSI Y14.5M, 1982.
2. CONTROLLING DIMENSION: INCH.
3. 418B-01 THRU 418B-03 OBSOLETE, NEW STANDARD 418B-04.

| DIM | INCHES |       | MILLIMETERS |       |
|-----|--------|-------|-------------|-------|
|     | MIN    | MAX   | MIN         | MAX   |
| A   | 0.340  | 0.380 | 8.64        | 9.65  |
| B   | 0.380  | 0.405 | 9.65        | 10.29 |
| C   | 0.160  | 0.190 | 4.06        | 4.83  |
| D   | 0.020  | 0.035 | 0.51        | 0.89  |
| E   | 0.045  | 0.055 | 1.14        | 1.40  |
| F   | 0.310  | 0.350 | 7.87        | 8.89  |
| G   | 0.100  | BSC   | 2.54        | BSC   |
| H   | 0.080  | 0.110 | 2.03        | 2.79  |
| J   | 0.018  | 0.025 | 0.46        | 0.64  |
| K   | 0.090  | 0.110 | 2.29        | 2.79  |
| L   | 0.052  | 0.072 | 1.32        | 1.83  |
| M   | 0.280  | 0.320 | 7.11        | 8.13  |
| N   | 0.197  | REF   | 5.00        | REF   |
| P   | 0.079  | REF   | 2.00        | REF   |
| R   | 0.039  | REF   | 0.99        | REF   |
| S   | 0.575  | 0.625 | 14.60       | 15.88 |
| V   | 0.045  | 0.055 | 1.14        | 1.40  |

**VARIABLE CONFIGURATION ZONE**



- |  |   |   |  |   |  |
|--|---|---|--|---|--|
| <b>STYLE 1:</b><br>PIN 1. BASE<br>2. COLLECTOR<br>3. EMITTER<br>4. COLLECTOR | <b>STYLE 2:</b><br>PIN 1. GATE<br>2. DRAIN<br>3. SOURCE<br>4. DRAIN | <b>STYLE 3:</b><br>PIN 1. ANODE<br>2. CATHODE<br>3. ANODE<br>4. CATHODE | <b>STYLE 4:</b><br>PIN 1. GATE<br>2. COLLECTOR<br>3. EMITTER<br>4. COLLECTOR | <b>STYLE 5:</b><br>PIN 1. CATHODE<br>2. ANODE<br>3. CATHODE<br>4. ANODE | <b>STYLE 6:</b><br>PIN 1. NO CONNECT<br>2. CATHODE<br>3. ANODE<br>4. CATHODE |
|--|---|---|--|---|--|

**MARKING INFORMATION AND FOOTPRINT ON PAGE 2**

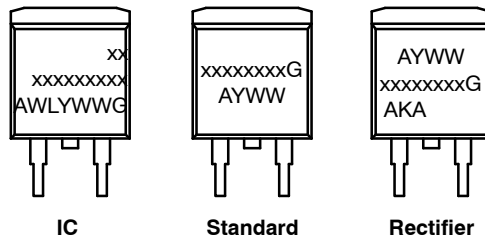
|                         |                           |  |
|-------------------------|---------------------------|--|
| <b>DOCUMENT NUMBER:</b> | <b>98ASB42761B</b>        | Electronic versions are uncontrolled except when accessed directly from the Document Repository. Printed versions are uncontrolled except when stamped "CONTROLLED COPY" in red. |
| <b>DESCRIPTION:</b>     | <b>D<sup>2</sup>PAK 3</b> | <b>PAGE 1 OF 2</b>   |

ON Semiconductor and are trademarks of Semiconductor Components Industries, LLC dba ON Semiconductor or its subsidiaries in the United States and/or other countries. ON Semiconductor reserves the right to make changes without further notice to any products herein. ON Semiconductor makes no warranty, representation or guarantee regarding the suitability of its products for any particular purpose, nor does ON Semiconductor assume any liability arising out of the application or use of any product or circuit, and specifically disclaims any and all liability, including without limitation special, consequential or incidental damages. ON Semiconductor does not convey any license under its patent rights nor the rights of others.

**D<sup>2</sup>PAK 3**  
CASE 418B-04  
ISSUE L

DATE 17 FEB 2015

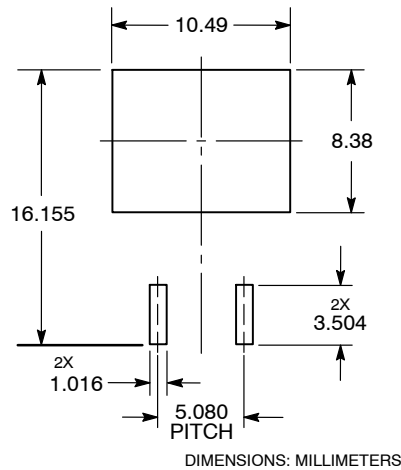
**GENERIC  
MARKING DIAGRAM\***



- xx = Specific Device Code
- A = Assembly Location
- WL = Wafer Lot
- Y = Year
- WW = Work Week
- G = Pb-Free Package
- AKA = Polarity Indicator

\*This information is generic. Please refer to device data sheet for actual part marking.  
Pb-Free indicator, "G" or microdot "▪", may or may not be present.

**SOLDERING FOOTPRINT\***



\*For additional information on our Pb-Free strategy and soldering details, please download the ON Semiconductor Soldering and Mounting Techniques Reference Manual, SOLDERRM/D.

|                         |                           |   |
|-------------------------|---------------------------|---|
| <b>DOCUMENT NUMBER:</b> | <b>98ASB42761B</b>        | Electronic versions are uncontrolled except when accessed directly from the Document Repository.<br>Printed versions are uncontrolled except when stamped "CONTROLLED COPY" in red. |
| <b>DESCRIPTION:</b>     | <b>D<sup>2</sup>PAK 3</b> | <b>PAGE 2 OF 2</b>  |

ON Semiconductor and are trademarks of Semiconductor Components Industries, LLC dba ON Semiconductor or its subsidiaries in the United States and/or other countries. ON Semiconductor reserves the right to make changes without further notice to any products herein. ON Semiconductor makes no warranty, representation or guarantee regarding the suitability of its products for any particular purpose, nor does ON Semiconductor assume any liability arising out of the application or use of any product or circuit, and specifically disclaims any and all liability, including without limitation special, consequential or incidental damages. ON Semiconductor does not convey any license under its patent rights nor the rights of others.

**onsemi**, **Onsemi**, and other names, marks, and brands are registered and/or common law trademarks of Semiconductor Components Industries, LLC dba "**onsemi**" or its affiliates and/or subsidiaries in the United States and/or other countries. **onsemi** owns the rights to a number of patents, trademarks, copyrights, trade secrets, and other intellectual property. A listing of **onsemi**'s product/patent coverage may be accessed at [www.onsemi.com/site/pdf/Patent-Marking.pdf](http://www.onsemi.com/site/pdf/Patent-Marking.pdf). **onsemi** reserves the right to make changes at any time to any products or information herein, without notice. The information herein is provided "as-is" and **onsemi** makes no warranty, representation or guarantee regarding the accuracy of the information, product features, availability, functionality, or suitability of its products for any particular purpose, nor does **onsemi** assume any liability arising out of the application or use of any product or circuit, and specifically disclaims any and all liability, including without limitation special, consequential or incidental damages. Buyer is responsible for its products and applications using **onsemi** products, including compliance with all laws, regulations and safety requirements or standards, regardless of any support or applications information provided by **onsemi**. "Typical" parameters which may be provided in **onsemi** data sheets and/or specifications can and do vary in different applications and actual performance may vary over time. All operating parameters, including "Typicals" must be validated for each customer application by customer's technical experts. **onsemi** does not convey any license under any of its intellectual property rights nor the rights of others. **onsemi** products are not designed, intended, or authorized for use as a critical component in life support systems or any FDA Class 3 medical devices or medical devices with a same or similar classification in a foreign jurisdiction or any devices intended for implantation in the human body. Should Buyer purchase or use **onsemi** products for any such unintended or unauthorized application, Buyer shall indemnify and hold **onsemi** and its officers, employees, subsidiaries, affiliates, and distributors harmless against all claims, costs, damages, and expenses, and reasonable attorney fees arising out of, directly or indirectly, any claim of personal injury or death associated with such unintended or unauthorized use, even if such claim alleges that **onsemi** was negligent regarding the design or manufacture of the part. **onsemi** is an Equal Opportunity/Affirmative Action Employer. This literature is subject to all applicable copyright laws and is not for resale in any manner.

---

## ADDITIONAL INFORMATION

### TECHNICAL PUBLICATIONS:

Technical Library: [www.onsemi.com/design/resources/technical-documentation](http://www.onsemi.com/design/resources/technical-documentation)  
onsemi Website: [www.onsemi.com](http://www.onsemi.com)

### ONLINE SUPPORT: [www.onsemi.com/support](http://www.onsemi.com/support)

For additional information, please contact your local Sales Representative at [www.onsemi.com/support/sales](http://www.onsemi.com/support/sales)