

8-Bit Shift Register with Output Latches

MM74HC595

General Description

The MM74HC595 high-speed shift register utilizes advanced silicon-gate CMOS technology. This device possesses the high noise immunity and low power consumption of standard CMOS integrated circuits, as well as the ability to drive 15 LS-TTL loads.

This device contains an eight-bit serial-in, parallel-out, shift register that feeds an eight-bit D-type storage register. The storage register has eight 3-state outputs. Separate clocks are provided for both the shift register and the storage register. The shift register has a direct-overriding clear, serial input, and serial output (standard) pins for cascading. Both the shift register and storage register use positive-edge triggered clocks. If both clocks are connected together, the shift register state is one clock pulse ahead of the storage register.

The 74HC logic family is speed, function, and pin-out compatible with the standard 74LS logic family. All inputs are protected from damage due to static discharge by internal diode clamps to V_{CC} and ground.

Features

- Low Quiescent Current: 160 μ A Maximum (74HC Series)
- Low Input Current: 1 μ A Maximum
- 8-Bit Serial-In, Parallel-Out Shift Register with Storage
- Wide Operating Voltage Range: 2 V–6 V
- Cascadable
- Shift Register has Direct Clear
- Guaranteed Shift Frequency: DC to 30 MHz
- This Device is Pb-Free and is RoHS Compliant

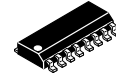

SOIC-16
CASE 751B-05

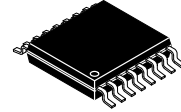

TSSOP 16
CASE 948AH-01

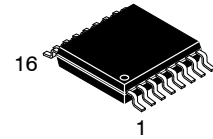

TSSOP-16
CASE 948F-01

MARKING DIAGRAMS

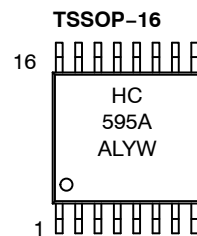
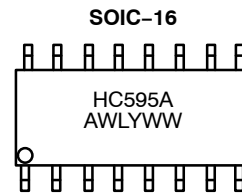

HC595A = Specific Device Code
A = Assembly Location
WL, L = Wafer Lot Number
Y = Year
WW, YW = Work Week

ORDERING INFORMATION

See detailed ordering and shipping information on page 8 of this data sheet.

MM74HC595

Block Diagram

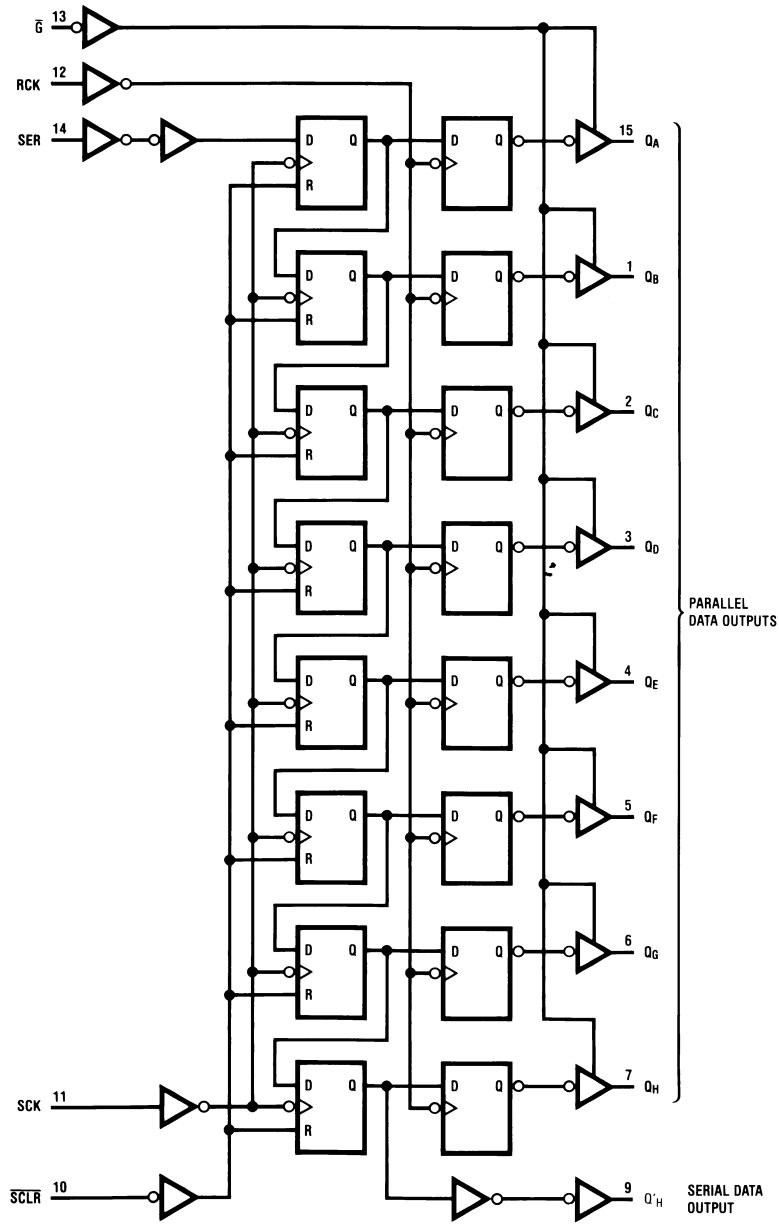

Figure 1. Logic Diagram (Positive Logic)

MM74HC595

Pin Configuration

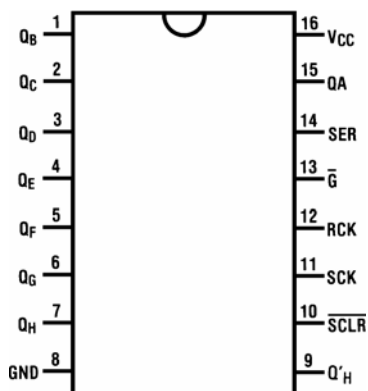

Figure 2. Pin Configuration

PIN DEFINITIONS

Pin No.	Symbol	Description
1	Q _B	Output Bit B
2	Q _C	Output Bit C
3	Q _D	Output Bit D
4	Q _E	Output Bit E
5	Q _F	Output Bit F
6	Q _G	Output Bit G
7	Q _H	Output Bit H
8	GND	Ground
9	Q' _H	Serial Data Output
10	SCLR	Shift Register Clear
11	SCK	Shift Register Clock Input
12	RCK	Storage Register Clock Input
13	Ḡ	Output Enable
14	SER	Serial Data Input
15	QA	Output Bit A
16	V _{CC}	Supply Voltage

TRUTH TABLE

RCK	SCK	SCLR	G	Function
X	X	X	H	QA through Q _H = 3-state
X	X	L	L	Shift register clocked; Q' _H = 0
X	↑	H	L	Shift register clocked; Q _N = Q _{n-1} , Q ₀ = SER
↑	X	H	L	Contents of shift; register transferred to output latches

NOTES: L = Logic Level LOW
H = Logic Level HIGH
X = Don't Care
↑ = Transition from LOW to HIGH level

MM74HC595

ABSOLUTE MAXIMUM RATINGS (Note 1)

Symbol	Rating	Min	Max	Unit	
V_{CC}	Supply Voltage	-0.5	7.0	V	
V_{IN}	DC Input Voltage	-0.5	$V_{CC} + 0.5$	V	
V_{OUT}	DC Output Voltage	-0.5	$V_{CC} + 0.5$	V	
I_{IK}, I_{OK}	Clamp Diode Current		± 20	mA	
I_{OUT}	DC Output Current, per pin		± 35	mA	
I_{CC}	DC VCC or GND Current, per pin		± 70	mA	
T_{STG}	Storage Temperature Range	-65	+150	°C	
P_D	Power Dissipation	SOIC Package only		500	mW
T_L	Lead Temperature		+260	°C	
ESD	Electrostatic Discharge Capability	Human Body Model, JESD22-A114		4000	V

Stresses exceeding those listed in the Maximum Ratings table may damage the device. If any of these limits are exceeded, device functionality should not be assumed, damage may occur and reliability may be affected.

1. Unless otherwise specified all voltages are referenced to ground.

RECOMMENDED OPERATING CONDITIONS

Symbol	Parameter	Min	Max	Unit	
V_{CC}	Supply Voltage	2	6	V	
V_{IN}, V_{OUT}	DC Input or Output Voltage	0	V_{CC}	V	
T_A	Operating Temperature Range	-55	+125	°C	
t_R, t_F	Input Rise and Fall Times	$V_{CC} = 2.0\text{ V}$	-	1000	ns
		$V_{CC} = 4.5\text{ V}$	-	500	
		$V_{CC} = 6.0\text{ V}$	-	400	

Functional operation above the stresses listed in the Recommended Operating Ranges is not implied. Extended exposure to stresses beyond the Recommended Operating Ranges limits may affect device reliability.

MM74HC595

ELECTRICAL CHARACTERISTICS (Note 2)

Symbol	Parameter	Conditions	V _{CC}	T _A = 25°C		T _A = -40 to 85°C	T _A = -55 to 125°C	Unit	
				Typ	Guaranteed Limits				
V _{IH}	Minimum HIGH Level Input Voltage		2.0 V		1.50	1.50	1.50	V	
			4.5 V		3.15	3.15	3.15	V	
			6.0 V		4.20	4.20	4.20	V	
V _{IL}	Minimum LOW Level Input Voltage		2.0 V		0.50	0.50	0.50	V	
			4.5 V		1.35	1.35	1.35	V	
			6.0 V		1.80	1.80	1.80	V	
V _{OH}	Minimum HIGH Level Output Voltage	V _{IN} = V _{IH} or V _{IL}	I _{OUT} ≤ 20 μA	2.0 V	2.00	1.90	1.90	1.90	V
				4.5 V	4.50	4.40	4.40	4.40	V
				6.0 V	6.00	5.90	5.90	5.90	V
Q' _H	Q' _H	V _{IN} = V _{IH} or V _{IL}	I _{OUT} ≤ 4.0 mA I _{OUT} ≤ 5.2 mA	4.5 V	4.20	3.98	3.84	3.70	V
				6.0 V	5.20	5.48	5.34	5.20	V
				QA through Q _H	V _{IN} = V _{IH} or V _{IL}	I _{OUT} ≤ 6.0 mA I _{OUT} ≤ 7.8 mA	4.5 V	4.20	3.98
6.0 V	5.70	5.48	5.34	5.20			V		
V _{OL}	Minimum LOW Level Output Voltage	V _{IN} = V _{IH} or V _{IL}	I _{OUT} ≤ 20 μA	2.0 V	0	0.10	0.10	0.10	V
				4.5 V	0	0.10	0.10	0.10	V
				6.0 V	0	0.10	0.10	0.10	V
Q' _H	Q' _H	V _{IN} = V _{IH} or V _{IL}	I _{OUT} ≤ 4.0 mA I _{OUT} ≤ 5.2 mA	4.5 V	0.20	0.26	0.33	0.40	V
				6.0 V	0.20	0.26	0.33	0.40	V
				QA through Q _H	V _{IN} = V _{IH} or V _{IL}	I _{OUT} ≤ 6.0 mA I _{OUT} ≤ 7.8 mA	4.5 V	0.20	0.26
6.0 V	0.20	0.26	0.33	0.40			V		
I _{IN}	Maximum Input Output Leakage	V _{IN} = V _{CC} or GND	6.0 V		±0.1	±1.0	±1.0	μA	
I _{OZ}	Maximum 3-STATE Output Leakage	V _{OUT} = V _{CC} or GND $\bar{G} = V_{IH}$	6.0 V		±0.5	±5.0	±10	μA	
I _{CC}	Maximum Quiescent Supply Current	V _{IN} = V _{CC} or GND I _{OUT} = 0 μA	6.0 V		8.0	80	160	μA	

Product parametric performance is indicated in the Electrical Characteristics for the listed test conditions, unless otherwise noted. Product performance may not be indicated by the Electrical Characteristics if operated under different conditions.

- For a power supply of 5 V ±10% the worst-case output voltages (V_{OH}, and V_{OL}) occur for HC at 4.5 V. The 4.5 V values should be used when designing with this supply. Worst-case V_{IH} and V_{IL} occur at V_{CC} = 5.5 V and 4.5 V, respectively; V_{IH} value at 5.5 V is 3.85 V. The worst case leakage current (I_{IN}, I_{CC}, and I_{OZ}) occur for CMOS at the higher voltage; so the 6.0 V values should be used.

AC ELECTRICAL CHARACTERISTICS

(V_{CC} = 5 V, T_A = 25°C, t_r = t_f = 6 ns)

Symbol	Parameter	Conditions	Typ	Guaranteed Limit	Unit
f _{MAX}	Maximum Operating Frequency of SCK		50	30	MHz
t _{PHL} , t _{PLH}	Maximum Propagation Delay, SCK to Q' _H	C _L = 45 pF	12	20	ns
	Maximum Propagation Delay, RCK to Q _A thru Q' _H				
t _{PZH} , t _{PZL}	Maximum Output Enable Time from \bar{G} to Q _A thru Q' _H	R _L = 1 kΩ C _L = 45 pF	17	28	ns
t _{PHZ} , t _{PLZ}	Maximum Output Disable Time from \bar{G} to Q _A thru Q' _H	R _L = 1 kΩ C _L = 45 pF	15	25	ns
t _S	Minimum Setup Time from SER to SCK			20	ns
	Minimum Setup Time from SCLR to SCK			20	ns
	Minimum Setup Time from SER to RCK (Note 3)			40	ns

MM74HC595

AC ELECTRICAL CHARACTERISTICS (continued)

($V_{CC} = 5\text{ V}$, $T_A = 25^\circ\text{C}$, $t_r = t_f = 6\text{ ns}$)

Symbol	Parameter	Conditions	Typ	Guaranteed Limit	Unit
t_H	Minimum Hold Time from SER to SCK			0	ns
t_W	Minimum Pulse Width of SCK or RCK			16	ns

Product parametric performance is indicated in the Electrical Characteristics for the listed test conditions, unless otherwise noted. Product performance may not be indicated by the Electrical Characteristics if operated under different conditions.

3. This setup time ensures the register will see stable data from the shift-register outputs. The clocks may be connected together in which case the storage register state will be one clock pulse behind the shift register.

ELECTRICAL CHARACTERISTICS

($V_{CC} = 2.0\text{ V} - 6.0\text{ V}$, $C_L = 50\text{ pF}$, $t_r = t_f = 6\text{ ns}$, unless otherwise specified)

Symbol	Parameter	Conditions	V_{CC}	$T_A = 25^\circ\text{C}$		$T_A = -40\text{ to }85^\circ\text{C}$	$T_A = -55\text{ to }125^\circ\text{C}$	Unit	
				Typ	Guaranteed Limits				
f_{MAX}	Maximum Operating Frequency	$C_L = 50\text{ pF}$	2.0 V	10.0	6.0	4.8	4.0	ns	
			4.5 V	45.0	30.0	24.0	20.0	ns	
			6.0 V	50.0	35.0	28.0	24.0	ns	
t_{PHL} , t_{PLH}	Maximum Propagation Delay, SCK to Q'_H	$C_L = 50\text{ pF}$	2.0 V	58.0	210.0	235.0	315.0	ns	
			2.0 V	83.0	294.0	367.0	441.0	ns	
		$C_L = 150\text{ pF}$	4.5 V	14.0	42.0	53.0	63.0	ns	
			4.5 V	17.0	58.0	74.0	88.0	ns	
		$C_L = 50\text{ pF}$	6.0 V	10.0	36.0	45.0	54.0	ns	
			6.0 V	14.0	50.0	63.0	76.0	ns	
	Maximum Propagation Delay, RCK to Q_A thru Q'_H	$C_L = 50\text{ pF}$	2.0 V	70.0	175.0	220.0	265.0	ns	
			2.0 V	105.0	245.0	306.0	368.0	ns	
		$C_L = 150\text{ pF}$	4.5 V	21.0	35.0	44.0	53.0	ns	
			4.5 V	28.0	49.0	61.0	74.0	ns	
		$C_L = 50\text{ pF}$	6.0 V	18.0	30.0	37.0	45.0	ns	
			6.0 V	26.0	42.0	53.0	63.0	ns	
Maximum Propagation Delay, \overline{SCLR} to Q'_H		2.0 V		175.0	221.0	261.0	ns		
		4.5 V		35.0	44.0	52.0	ns		
		6.0 V		30.0	37.0	44.0	ns		
t_{PZH} , t_{PZL}	Maximum Output Enable Time from \overline{G} to Q_A thru Q'_H	$R_L = 1\text{ k}\Omega$	$C_L = 50\text{ pF}$	2.0 V	75.0	175.0	220.0	265.0	ns
			$C_L = 150\text{ pF}$	2.0 V	100.0	245.0	306.0	368.0	ns
		$C_L = 50\text{ pF}$	4.5 V	15.0	35.0	44.0	53.0	ns	
			4.5 V	20.0	49.0	61.0	74.0	ns	
		$C_L = 150\text{ pF}$	6.0 V	13.0	30.0	37.0	45.0	ns	
			6.0 V	17.0	42.0	53.0	63.0	ns	
t_{PHZ} , t_{PLZ}	Maximum Output Disable Time from \overline{G} to Q_A thru Q'_H	$R_L = 1\text{ k}\Omega$	$C_L = 50\text{ pF}$	2.0 V	75.0	175.0	220.0	265.0	ns
			4.5 V	15.0	35.0	44.0	53.0	ns	
			6.0 V	13.0	30.0	37.0	45.0	ns	
t_S	Minimum Setup Time from SER to SCK	$R_L = 1\text{ k}\Omega$	$C_L = 50\text{ pF}$	2.0 V		100.0	125.0	150.0	ns
			4.5 V		20.0	25.0	30.0	ns	
			6.0 V		17.0	21.0	25.0	ns	
t_R	Minimum Removal Time from \overline{SCLR} to SCK		2.0 V		50.0	63.0	75.0	ns	
			4.5 V		10.0	13.0	15.0	ns	
			6.0 V		9.0	11.0	13.0	ns	
t_S	Minimum Setup Time from SCK to RCK		2.0 V		100.0	125.0	150.0	ns	
			4.5 V		20.0	25.0	30.0	ns	
			6.0 V		17.0	21.0	26.0	ns	

MM74HC595

ELECTRICAL CHARACTERISTICS (continued)

($V_{CC} = 2.0\text{ V} - 6.0\text{ V}$, $C_L = 50\text{ pF}$, $t_r = t_f = 6\text{ ns}$, unless otherwise specified)

Symbol	Parameter	Conditions	V_{CC}	$T_A = 25^\circ\text{C}$		$T_A = -40\text{ to }85^\circ\text{C}$	$T_A = -55\text{ to }125^\circ\text{C}$	Unit
				Typ	Guaranteed Limits			
t_H	Minimum Hold Time from SER to SCK		2.0 V		5.0	5.0	5.0	ns
			4.5 V		5.0	5.0	5.0	ns
			6.0 V		5.0	5.0	5.0	ns
t_W	Minimum Pulse Width of SCK or SCLR		2.0 V	30.0	80.0	100.0	120.0	ns
			4.5 V	9.0	16.0	20.0	24.0	ns
			6.0 V	8.0	14.0	18.0	22.0	ns
t_R, t_F	Maximum Input Rise and Fall Time, Clock		2.0 V		1000.0	1000.0	1000.0	ns
			4.5 V		500.0	500.0	500.0	ns
			6.0 V		400.0	400.0	400.0	ns
t_{THL}, t_{TLH}	Maximum Output Rise and Fall Time $Q_A - Q_H$		2.0 V	25.0	60.0	75.0	90.0	ns
			4.5 V	7.0	12.0	15.0	18.0	ns
			6.0 V	6.0	10.0	13.0	15.0	ns
	Maximum Output Rise and Fall Time Q'_H		2.0 V		75.0	95.0	110.0	ns
			4.5 V		15.0	19.0	22.0	ns
			6.0 V		13.0	16.0	19.0	ns
C_{PD}	Power Dissipation Capacitance, Outputs Enabled (Note 4)	$\bar{G} = V_{CC}$ $\bar{G} = \text{GND}$		90.0				pF
				150.0				pF
C_{IN}	Maximum Input Capacitance			5.0	10.0	10.0	10.0	pF
C_{OUT}	Maximum Output Capacitance			15.0	20.0	20.0	20.0	pF

Product parametric performance is indicated in the Electrical Characteristics for the listed test conditions, unless otherwise noted. Product performance may not be indicated by the Electrical Characteristics if operated under different conditions.

4. C_{PD} determines the no load dynamic power consumption, $P_D = C_{PD} V_{CC}^2 f + I_{CC} V_{CC}$, and the no load dynamic current consumption, $I_S = C_{PD} V_{CC} f + I_{CC}$.

Timing Diagram

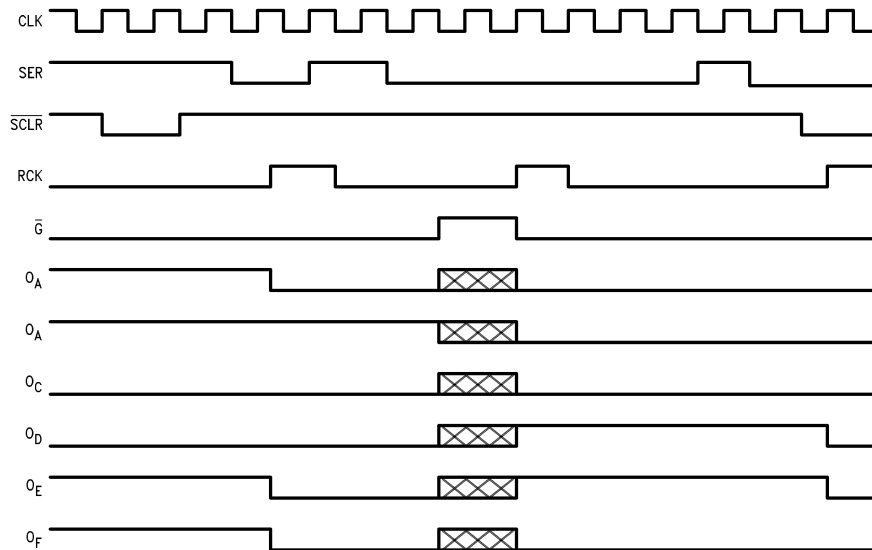

NOTE:

5.  Implies that the output is in 3-state mode.

Figure 3. Timing Diagram

MM74HC595

ORDERING INFORMATION

Device	Package	Shipping [†]
MM74HC595M	SOIC-16 (Pb-Free)	48 Units / Tube
MM74HC595MX		2500 / Tape & Reel
MM74HC595MTC	TSSOP-16 (Pb-Free and Halide Free)	96 Units / Tube
MM74HC595MTCX	TSSOP 16 (Pb-Free and Halide Free)	2500 / Tape & Reel

[†]For information on tape and reel specifications, including part orientation and tape sizes, please refer to our Tape and Reel Packaging Specifications Brochure, [BRD8011/D](#).

MECHANICAL CASE OUTLINE PACKAGE DIMENSIONS

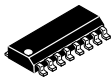

SCALE 1:1

SOIC-16
CASE 751B-05
ISSUE K

DATE 29 DEC 2006

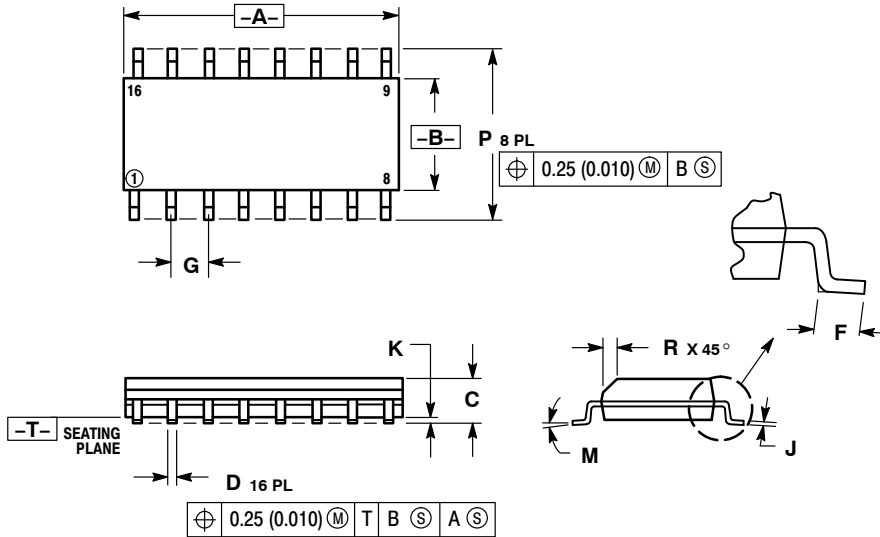

NOTES:

1. DIMENSIONING AND TOLERANCING PER ANSI Y14.5M, 1982.
2. CONTROLLING DIMENSION: MILLIMETER.
3. DIMENSIONS A AND B DO NOT INCLUDE MOLD PROTRUSION.
4. MAXIMUM MOLD PROTRUSION 0.15 (0.006) PER SIDE.
5. DIMENSION D DOES NOT INCLUDE DAMBAR PROTRUSION. ALLOWABLE DAMBAR PROTRUSION SHALL BE 0.127 (0.005) TOTAL IN EXCESS OF THE D DIMENSION AT MAXIMUM MATERIAL CONDITION.

DIM	MILLIMETERS		INCHES	
	MIN	MAX	MIN	MAX
A	9.80	10.00	0.386	0.393
B	3.80	4.00	0.150	0.157
C	1.35	1.75	0.054	0.068
D	0.35	0.49	0.014	0.019
F	0.40	1.25	0.016	0.049
G	1.27 BSC		0.050 BSC	
J	0.19	0.25	0.008	0.009
K	0.10	0.25	0.004	0.009
M	0° 7°		0° 7°	
P	5.80	6.20	0.229	0.244
R	0.25	0.50	0.010	0.019

- | | | | |
|----------------------------------------------------------------------------------------------------------------------------------------------------------------------------------------------------------------------------------------------------------------------------------------------------------------------------------------------------------------|--------------------------------------------------------------------------------------------------------------------------------------------------------------------------------------------------------------------------------------------------------------------------------------------------------------------------------------------|--------------------------------------------------------------------------------------------------------------------------------------------------------------------------------------------------------------------------------------------------------------------------------------------------------------------------------------------------------------------------------------------------------------------------------------------------------------------------------------------|----------------------------------------------------------------------------------------------------------------------------------------------------------------------------------------------------------------------------------------------------------------------------------------------------------------------------------------------------------------------------------------------------|
| <p>STYLE 1:</p> <p>PIN 1. COLLECTOR</p> <p>2. BASE</p> <p>3. EMITTER</p> <p>4. NO CONNECTION</p> <p>5. EMITTER</p> <p>6. BASE</p> <p>7. COLLECTOR</p> <p>8. COLLECTOR</p> <p>9. BASE</p> <p>10. EMITTER</p> <p>11. NO CONNECTION</p> <p>12. EMITTER</p> <p>13. BASE</p> <p>14. COLLECTOR</p> <p>15. EMITTER</p> <p>16. COLLECTOR</p> | <p>STYLE 2:</p> <p>PIN 1. CATHODE</p> <p>2. ANODE</p> <p>3. NO CONNECTION</p> <p>4. CATHODE</p> <p>5. CATHODE</p> <p>6. NO CONNECTION</p> <p>7. ANODE</p> <p>8. CATHODE</p> <p>9. CATHODE</p> <p>10. ANODE</p> <p>11. NO CONNECTION</p> <p>12. CATHODE</p> <p>13. CATHODE</p> <p>14. NO CONNECTION</p> <p>15. ANODE</p> <p>16. CATHODE</p> | <p>STYLE 3:</p> <p>PIN 1. COLLECTOR, DYE #1</p> <p>2. BASE, #1</p> <p>3. EMITTER, #1</p> <p>4. COLLECTOR, #1</p> <p>5. COLLECTOR, #2</p> <p>6. BASE, #2</p> <p>7. EMITTER, #2</p> <p>8. COLLECTOR, #2</p> <p>9. COLLECTOR, #3</p> <p>10. BASE, #3</p> <p>11. EMITTER, #3</p> <p>12. COLLECTOR, #3</p> <p>13. COLLECTOR, #4</p> <p>14. BASE, #4</p> <p>15. EMITTER, #4</p> <p>16. COLLECTOR, #4</p> | <p>STYLE 4:</p> <p>PIN 1. COLLECTOR, DYE #1</p> <p>2. COLLECTOR, #1</p> <p>3. COLLECTOR, #2</p> <p>4. COLLECTOR, #2</p> <p>5. COLLECTOR, #3</p> <p>6. COLLECTOR, #3</p> <p>7. COLLECTOR, #4</p> <p>8. COLLECTOR, #4</p> <p>9. BASE, #4</p> <p>10. EMITTER, #4</p> <p>11. BASE, #3</p> <p>12. EMITTER, #3</p> <p>13. BASE, #2</p> <p>14. EMITTER, #2</p> <p>15. BASE, #1</p> <p>16. EMITTER, #1</p> |
| <p>STYLE 5:</p> <p>PIN 1. DRAIN, DYE #1</p> <p>2. DRAIN, #1</p> <p>3. DRAIN, #2</p> <p>4. DRAIN, #2</p> <p>5. DRAIN, #3</p> <p>6. DRAIN, #3</p> <p>7. DRAIN, #4</p> <p>8. DRAIN, #4</p> <p>9. GATE, #4</p> <p>10. SOURCE, #4</p> <p>11. GATE, #3</p> <p>12. SOURCE, #3</p> <p>13. GATE, #2</p> <p>14. SOURCE, #2</p> <p>15. GATE, #1</p> <p>16. SOURCE, #1</p> | <p>STYLE 6:</p> <p>PIN 1. CATHODE</p> <p>2. CATHODE</p> <p>3. CATHODE</p> <p>4. CATHODE</p> <p>5. CATHODE</p> <p>6. CATHODE</p> <p>7. CATHODE</p> <p>8. CATHODE</p> <p>9. ANODE</p> <p>10. ANODE</p> <p>11. ANODE</p> <p>12. ANODE</p> <p>13. ANODE</p> <p>14. ANODE</p> <p>15. ANODE</p> <p>16. ANODE</p> | <p>STYLE 7:</p> <p>PIN 1. SOURCE N-CH</p> <p>2. COMMON DRAIN (OUTPUT)</p> <p>3. COMMON DRAIN (OUTPUT)</p> <p>4. GATE P-CH</p> <p>5. COMMON DRAIN (OUTPUT)</p> <p>6. COMMON DRAIN (OUTPUT)</p> <p>7. COMMON DRAIN (OUTPUT)</p> <p>8. SOURCE P-CH</p> <p>9. SOURCE P-CH</p> <p>10. COMMON DRAIN (OUTPUT)</p> <p>11. COMMON DRAIN (OUTPUT)</p> <p>12. COMMON DRAIN (OUTPUT)</p> <p>13. GATE N-CH</p> <p>14. COMMON DRAIN (OUTPUT)</p> <p>15. COMMON DRAIN (OUTPUT)</p> <p>16. SOURCE N-CH</p> | |

RECOMMENDED
SOLDERING FOOTPRINT*

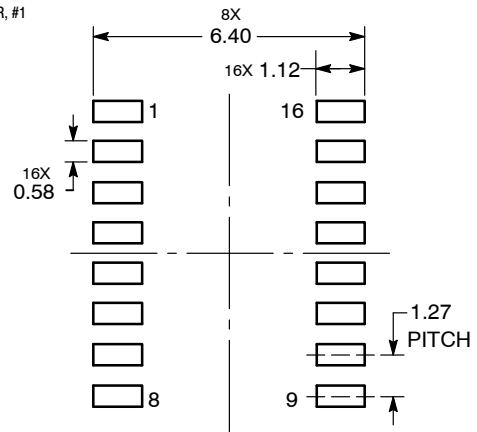

DIMENSIONS: MILLIMETERS

*For additional information on our Pb-Free strategy and soldering details, please download the onsemi Soldering and Mounting Techniques Reference Manual, SOLDERRM/D.

DOCUMENT NUMBER:	98ASB42566B	Electronic versions are uncontrolled except when accessed directly from the Document Repository. Printed versions are uncontrolled except when stamped "CONTROLLED COPY" in red.
DESCRIPTION:	SOIC-16	PAGE 1 OF 1

onsemi and onsemi are trademarks of Semiconductor Components Industries, LLC dba onsemi or its subsidiaries in the United States and/or other countries. onsemi reserves the right to make changes without further notice to any products herein. onsemi makes no warranty, representation or guarantee regarding the suitability of its products for any particular purpose, nor does onsemi assume any liability arising out of the application or use of any product or circuit, and specifically disclaims any and all liability, including without limitation special, consequential or incidental damages. onsemi does not convey any license under its patent rights nor the rights of others.

MECHANICAL CASE OUTLINE

PACKAGE DIMENSIONS

ON Semiconductor®



TSSOP 16
CASE 948AH-01
ISSUE O

DATE 19 SEP 2008

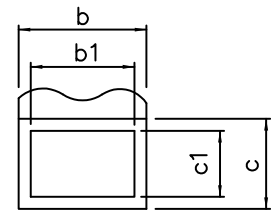
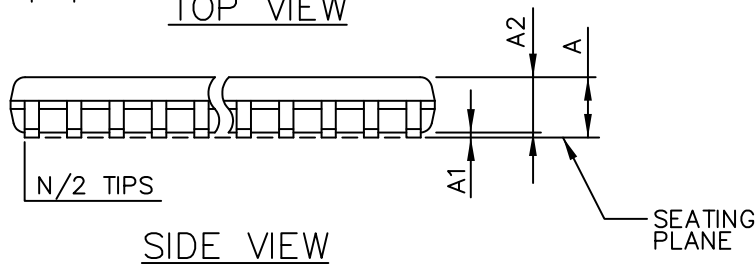
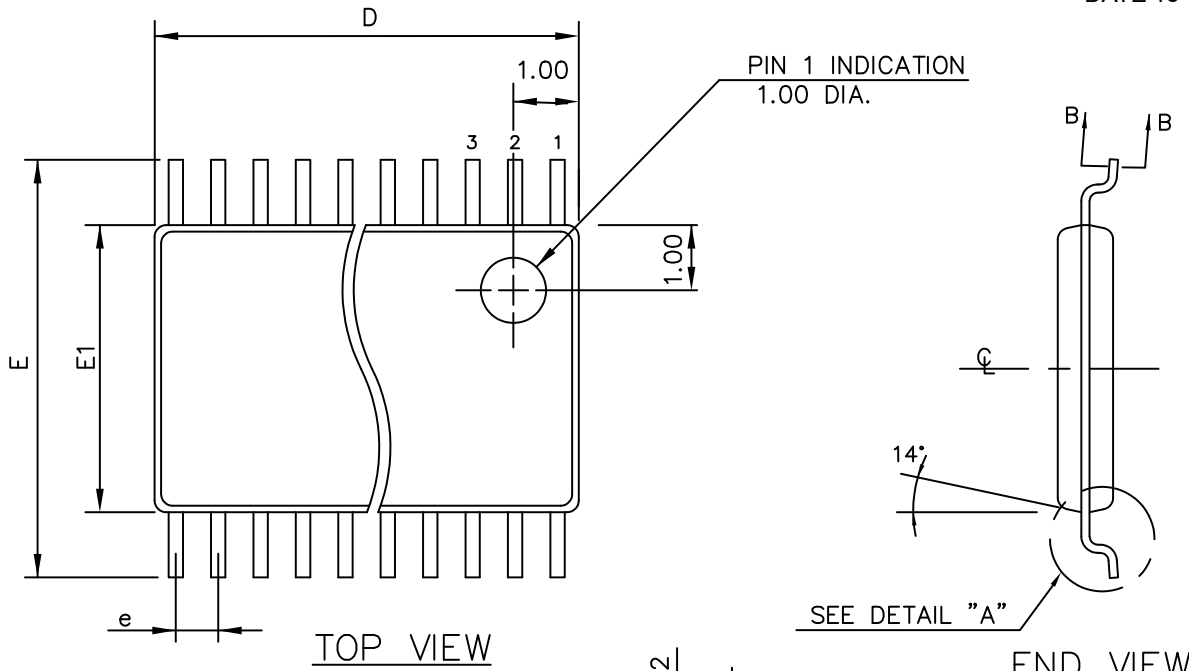

SECTION "B-B"

THIS TABLE FOR 0.65mm PITCH

SYMBOL	COMMON DIMENSIONS			NOTE VARIATIONS	D	N
	MIN.	NOM.	MAX.			
A	—	—	1.10	AA/AAT	3.00 BSC	8
A ₁	0.05	—	0.15	AB-1/ABT	5.00 BSC	14
A ₂	0.85	0.90	0.95	AB/ABT	5.00 BSC	16
b	0.19	—	0.30	AD/ADT	7.80 BSC	24
b ₁	0.19	0.22	0.25			
c	0.09	—	0.20			
c ₁	0.09	0.127	0.16			
D	SEE VARIATIONS					
E ₁	4.30	4.40	4.50			
e	0.65 BSC					
E	6.40 BSC					
L	0.50	0.60	0.70			
L ₁	1.00 REF					
N	SEE VARIATIONS					
X	0°	—	8°			

ALL DIMENSIONS IN MILLIMETERS

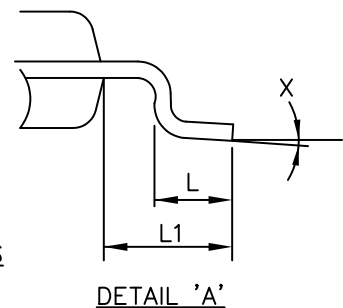

MOLD FLASH OR PROTRUSIONS SHALL NOT EXCEED 0.15mm ON D PER SIDE

DOCUMENT NUMBER:	98AON34923E	Electronic versions are uncontrolled except when accessed directly from the Document Repository. Printed versions are uncontrolled except when stamped "CONTROLLED COPY" in red.
DESCRIPTION:	TSSOP 16	PAGE 1 OF 1

ON Semiconductor and are trademarks of Semiconductor Components Industries, LLC dba ON Semiconductor or its subsidiaries in the United States and/or other countries. ON Semiconductor reserves the right to make changes without further notice to any products herein. ON Semiconductor makes no warranty, representation or guarantee regarding the suitability of its products for any particular purpose, nor does ON Semiconductor assume any liability arising out of the application or use of any product or circuit, and specifically disclaims any and all liability, including without limitation special, consequential or incidental damages. ON Semiconductor does not convey any license under its patent rights nor the rights of others.

MECHANICAL CASE OUTLINE PACKAGE DIMENSIONS

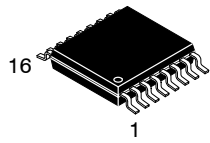

TSSOP-16 WB
CASE 948F
ISSUE B

DATE 19 OCT 2006



NOTES:

- DIMENSIONING AND TOLERANCING PER ANSI Y14.5M, 1982.
- CONTROLLING DIMENSION: MILLIMETER.
- DIMENSION A DOES NOT INCLUDE MOLD FLASH, PROTRUSIONS OR GATE BURRS. MOLD FLASH OR GATE BURRS SHALL NOT EXCEED 0.15 (0.006) PER SIDE.
- DIMENSION B DOES NOT INCLUDE INTERLEAD FLASH OR PROTRUSION. INTERLEAD FLASH OR PROTRUSION SHALL NOT EXCEED 0.25 (0.010) PER SIDE.
- DIMENSION K DOES NOT INCLUDE DAMBAR PROTRUSION. ALLOWABLE DAMBAR PROTRUSION SHALL BE 0.08 (0.003) TOTAL IN EXCESS OF THE K DIMENSION AT MAXIMUM MATERIAL CONDITION.
- TERMINAL NUMBERS ARE SHOWN FOR REFERENCE ONLY.
- DIMENSION A AND B ARE TO BE DETERMINED AT DATUM PLANE -W-.

DIM	MILLIMETERS		INCHES	
	MIN	MAX	MIN	MAX
A	4.90	5.10	0.193	0.200
B	4.30	4.50	0.169	0.177
C	---	1.20	---	0.047
D	0.05	0.15	0.002	0.006
F	0.50	0.75	0.020	0.030
G	0.65 BSC		0.026 BSC	
H	0.18	0.28	0.007	0.011
J	0.09	0.20	0.004	0.008
J1	0.09	0.16	0.004	0.006
K	0.19	0.30	0.007	0.012
K1	0.19	0.25	0.007	0.010
L	6.40 BSC		0.252 BSC	
M	0°	8°	0°	8°

RECOMMENDED
SOLDERING FOOTPRINT*

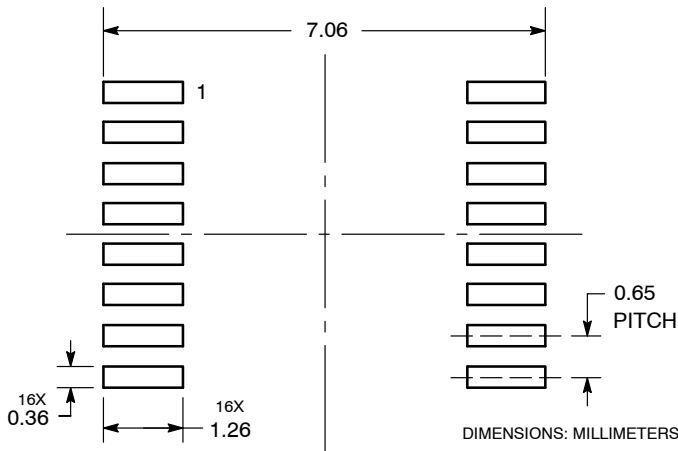

GENERIC
MARKING DIAGRAM*

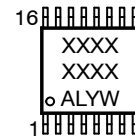

- XXXX = Specific Device Code
- A = Assembly Location
- L = Wafer Lot
- Y = Year
- W = Work Week
- G or ■ = Pb-Free Package

*This information is generic. Please refer to device data sheet for actual part marking. Pb-Free indicator, "G" or microdot "■", may or may not be present. Some products may not follow the Generic Marking.

*For additional information on our Pb-Free strategy and soldering details, please download the onsemi Soldering and Mounting Techniques Reference Manual, SOLDERRM/D.

DOCUMENT NUMBER:	98ASH70247A	Electronic versions are uncontrolled except when accessed directly from the Document Repository. Printed versions are uncontrolled except when stamped "CONTROLLED COPY" in red.
DESCRIPTION:	TSSOP-16	PAGE 1 OF 1

onsemi and onsemi are trademarks of Semiconductor Components Industries, LLC dba onsemi or its subsidiaries in the United States and/or other countries. onsemi reserves the right to make changes without further notice to any products herein. onsemi makes no warranty, representation or guarantee regarding the suitability of its products for any particular purpose, nor does onsemi assume any liability arising out of the application or use of any product or circuit, and specifically disclaims any and all liability, including without limitation special, consequential or incidental damages. onsemi does not convey any license under its patent rights nor the rights of others.

onsemi, **Onsemi**, and other names, marks, and brands are registered and/or common law trademarks of Semiconductor Components Industries, LLC dba "**onsemi**" or its affiliates and/or subsidiaries in the United States and/or other countries. **onsemi** owns the rights to a number of patents, trademarks, copyrights, trade secrets, and other intellectual property. A listing of **onsemi**'s product/patent coverage may be accessed at www.onsemi.com/site/pdf/Patent-Marking.pdf. **onsemi** reserves the right to make changes at any time to any products or information herein, without notice. The information herein is provided "as-is" and **onsemi** makes no warranty, representation or guarantee regarding the accuracy of the information, product features, availability, functionality, or suitability of its products for any particular purpose, nor does **onsemi** assume any liability arising out of the application or use of any product or circuit, and specifically disclaims any and all liability, including without limitation special, consequential or incidental damages. Buyer is responsible for its products and applications using **onsemi** products, including compliance with all laws, regulations and safety requirements or standards, regardless of any support or applications information provided by **onsemi**. "Typical" parameters which may be provided in **onsemi** data sheets and/or specifications can and do vary in different applications and actual performance may vary over time. All operating parameters, including "Typicals" must be validated for each customer application by customer's technical experts. **onsemi** does not convey any license under any of its intellectual property rights nor the rights of others. **onsemi** products are not designed, intended, or authorized for use as a critical component in life support systems or any FDA Class 3 medical devices or medical devices with a same or similar classification in a foreign jurisdiction or any devices intended for implantation in the human body. Should Buyer purchase or use **onsemi** products for any such unintended or unauthorized application, Buyer shall indemnify and hold **onsemi** and its officers, employees, subsidiaries, affiliates, and distributors harmless against all claims, costs, damages, and expenses, and reasonable attorney fees arising out of, directly or indirectly, any claim of personal injury or death associated with such unintended or unauthorized use, even if such claim alleges that **onsemi** was negligent regarding the design or manufacture of the part. **onsemi** is an Equal Opportunity/Affirmative Action Employer. This literature is subject to all applicable copyright laws and is not for resale in any manner.

ADDITIONAL INFORMATION

TECHNICAL PUBLICATIONS:

Technical Library: www.onsemi.com/design/resources/technical-documentation
onsemi Website: www.onsemi.com

ONLINE SUPPORT: www.onsemi.com/support

For additional information, please contact your local Sales Representative at www.onsemi.com/support/sales