

NCP699

LDO Regulator - CMOS, Low Iq, Enable, TSOP-5

150 mA

The NCP699 series of fixed output LDO's are designed for handheld communication equipment and portable battery powered applications which require low quiescent current. The NCP699 series features a very low ground current of 40 μ A, independent of load current. Each device contains a voltage reference unit, an error amplifier, a PMOS power transistor, internal resistors for setting output voltage, current limit, and temperature limit protection circuits.

The NCP699 has been designed to be used with low cost capacitors. The device is housed in the micro-miniature TSOP-5 surface mount package. Standard voltage versions are 1.3, 1.4, 1.5, 1.8, 2.5, 2.8, 2.9, 3.0, 3.1, 3.3, 3.4, 4.5 and 5.0 V. Other voltages are available in 100 mV steps.

Features

- Enable Control (Active High, Supports Sub 1 V Logic)
- Very Low Ground Current of 40 μ A Typical
- Low Dropout Voltage of 340 mV at 150 mA, and 3.0 V V_{out}
- Multiple Fixed Output Voltage Option
- Output Voltage Accuracy of 2.0%
- Operating Temperature Range of -40° C to 85° C
- Stable with 1 μ F Ceramic or Tantalum Capacitors
- These are Pb-Free Devices

Typical Applications

- Cellular Phones
- Battery Powered Consumer Products
- Hand-Held Instruments
- Camcorders and Cameras
- Printers and Office Equipment

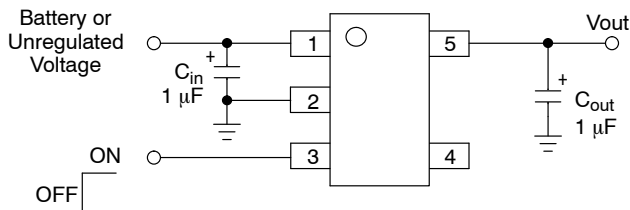

This device contains 86 active transistors

Figure 1. Typical Application Diagram



ON Semiconductor®

<http://onsemi.com>

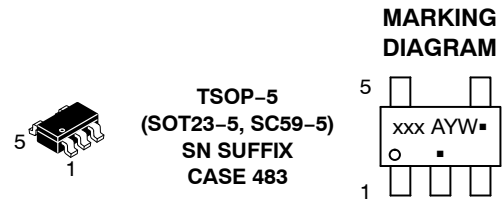

xxx = Specific Device Code
A = Assembly Location
Y = Year
W = Work Week
▪ = Pb-Free Package

(Note: Microdot may be in either location)

PIN CONNECTIONS

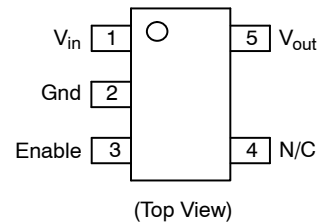

ORDERING INFORMATION

See detailed ordering and shipping information in the package dimensions section on page 7 of this data sheet.

NCP699

PIN FUNCTION DESCRIPTION

Pin No.	Pin Name	Description
1	Vin	Positive power supply input voltage.
2	Gnd	Power supply ground.
3	Enable	This input is used to place the device into low-power standby. When this input is pulled low, the device is disabled. If this function is not used, Enable should be connected to Vin.
4	N/C	No internal connection.
5	Vout	Regulated output voltage.

MAXIMUM RATINGS

Rating	Symbol	Value	Unit
Input Voltage	V_{in}	2.1 to 6.0	V
Enable Voltage	Enable	-0.3 to $V_{in} + 0.3$	V
Output Voltage	V_{out}	-0.3 to $V_{in} + 0.3$	V
Power Dissipation	P_D	Internally Limited	W
Operating Junction Temperature	T_J	+150	°C
Maximum Junction Temperature	$T_{J(max)}$	+150	°C
Operating Ambient Temperature	T_A	-40 to +85	°C
Storage Temperature	T_{stg}	-55 to +150	°C

Stresses exceeding Maximum Ratings may damage the device. Maximum Ratings are stress ratings only. Functional operation above the Recommended Operating Conditions is not implied. Extended exposure to stresses above the Recommended Operating Conditions may affect device reliability.

1. This device series contains ESD protection and exceeds the following tests:
Human Body Model 2000 V per MIL-STD-883, Method 3015
Machine Model Method 200 V
2. Latch-up capability (85°C) ± 200 mA DC with trigger voltage.

THERMAL CHARACTERISTICS

Rating	Symbol	Test Conditions	Typical Value	Unit
Junction-to-Ambient	$R_{\theta JA}$	1 oz Copper Thickness, 100 mm ²	250	°C/W
PSIJ-Lead 2	Ψ_{JL2}	1 oz Copper Thickness, 100 mm ²	68	°C/W

NOTE: Single component mounted on an 80 x 80 x 1.5 mm FR4 PCB with stated copper head spreading area. Using the following boundary conditions as stated in EIA/JESD 51-1, 2, 3, 7, 12.

NCP699

ELECTRICAL CHARACTERISTICS ($V_{in} = V_{out(nom.)} + 1.0\text{ V}$, $V_{enable} = V_{in}$, $C_{in} = 1.0\ \mu\text{F}$, $C_{out} = 1.0\ \mu\text{F}$, $T_A = 25^\circ\text{C}$, unless otherwise noted.)

Characteristic	Symbol	Min	Typ	Max	Unit
Output Voltage ($I_{out} = 10\text{ mA}$, $T_A = -40^\circ\text{C}$ to 85°C)	V_{out}				V
1.3 V		1.261	1.3	1.339	
1.4 V		1.358	1.4	1.442	
1.5 V		1.455	1.5	1.545	
1.8 V		1.746	1.8	1.854	
2.5 V		2.425	2.5	2.575	
2.8 V		2.716	2.8	2.884	
2.9 V		2.813	2.9	2.987	
3.0 V		2.910	3.0	3.090	
3.1 V		3.007	3.1	3.193	
3.3 V		3.201	3.3	3.399	
3.4 V		3.298	3.4	3.502	
4.5 V		4.365	4.5	4.635	
5.0 V		4.850	5.0	5.150	
Line Regulation ($I_{out} = 10\text{ mA}$)	Reg_{line}				mV/V
1.3 V–4.4 V ($V_{in} = V_{out(nom.)} + 1.0\text{ V}$ to 6.0 V)		–	1.0	3.0	
4.5 V–5.0 V ($V_{in} = 5.5\text{ V}$ to 6.0 V)		–	1.0	3.0	
Load Regulation ($I_{out} = 1.0\text{ mA}$ to 150 mA)	Reg_{load}	–	0.3	0.8	mV/mA
Output Current Limit	$I_{o(nom.)}$				mA
1.3 V–3.9 V ($V_{in} = V_{out(nom.)} + 2.0\text{ V}$)		150	240	–	
4.0 V–5.0 V ($V_{in} = 6.0\text{ V}$)		150	240	–	
Dropout Voltage ($I_{out} = 150\text{ mA}$, Measured at $V_{out} = V_{out(nom.)} - 3.0\%$)	$V_{in} - V_{out}$				mV
1.3 V		–	800	900	
1.4 V		–	750	850	
1.5 V		–	690	750	
1.8 V		–	570	620	
2.5 V		–	400	450	
2.8 V		–	360	420	
2.9 V		–	350	420	
3.0 V		–	340	400	
3.1 V		–	330	400	
3.3 V		–	320	360	
3.4 V		–	300	360	
4.5 V – 5.0 V		–	240	300	
Disable Current ($T_A = -40^\circ\text{C}$ to 85°C) (Enable Input = 0 V)	DIS	–	0.03	1.0	μA
Ground Current ($T_A = -40^\circ\text{C}$ to 85°C) (Enable Input = V_{in} , $I_{out} = 1.0\text{ mA}$ to $I_{o(nom.)}$)	I_{GND}	–	40	90	μA
Output Short Circuit Current ($V_{out} = 0\text{ V}$)	$I_{out(max)}$				mA
1.3 V–3.9 V ($V_{in} = V_{out(nom.)} + 2.0\text{ V}$)		150	300	600	
4.0 V–5.0 V ($V_{in} = 6.0\text{ V}$)		150	300	600	
Output Voltage Noise ($f = 100\text{ Hz}$ to 100 kHz) $I_{out} = 30\text{ mA}$, $C_{out} = 1\ \mu\text{F}$	V_n	–	100	–	μV_{rms}
Ripple Rejection ($f = 120\text{ Hz}$, 15 mA) ($f = 1.0\text{ kHz}$, 15 mA)	RR	–	55 50	–	dB
Enable Input Threshold Voltage ($T_A = -40^\circ\text{C}$ to 85°C) (Voltage Increasing, Output Turns On, Logic High) (Voltage Decreasing, Output Turns Off, Logic Low)	$V_{th(en)}$	0.95	–	– 0.3	V
Output Voltage Temperature Coefficient	T_C	–	± 100	–	ppm/ $^\circ\text{C}$

3. Maximum package power dissipation limits must be observed.

$$PD = \frac{T_J(max) - T_A}{R_{\theta JA}}$$

4. Low duty cycle pulse techniques are used during testing to maintain the junction temperature as close to ambient as possible.

NCP699

TYPICAL CHARACTERISTICS

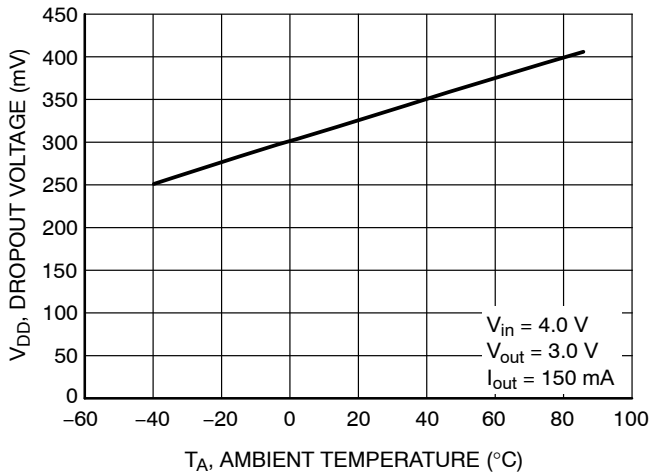

Figure 2. Dropout Voltage vs. Temperature

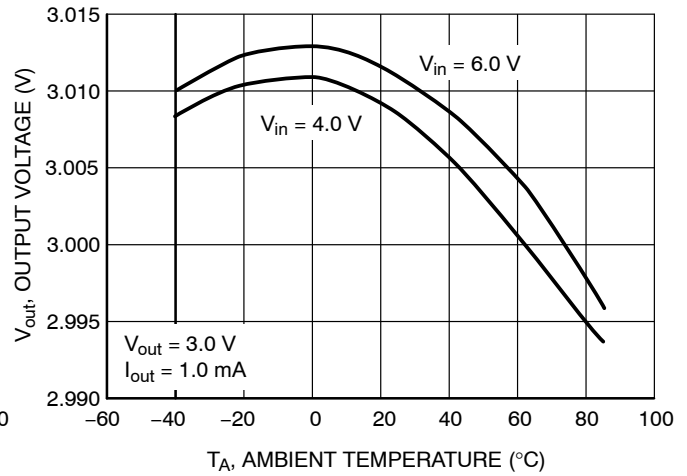

Figure 3. Output Voltage vs. Temperature

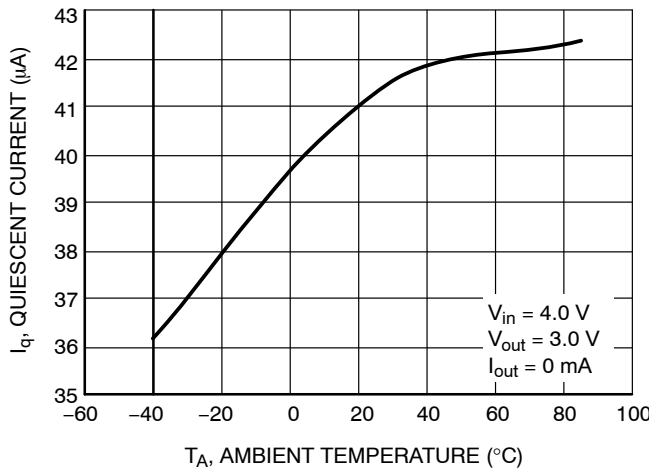

Figure 4. Quiescent Current vs. Temperature

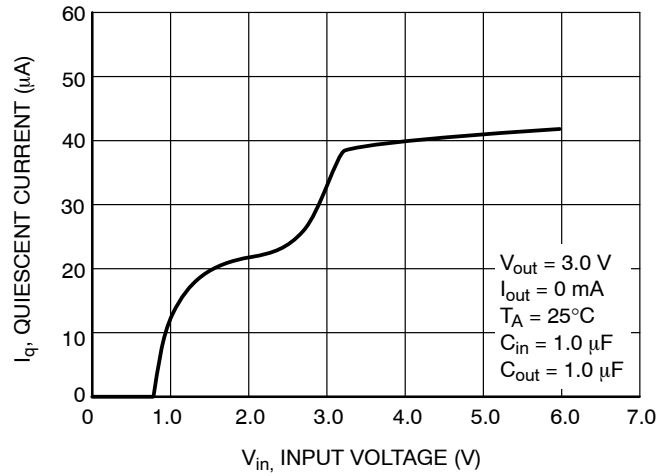

Figure 5. Quiescent Current vs. Input Voltage

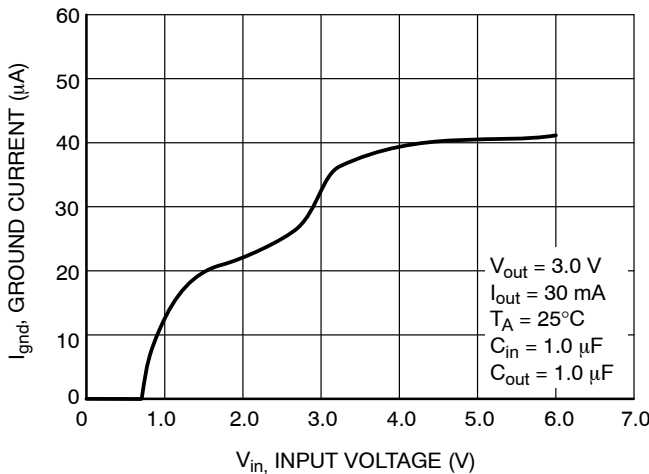

Figure 6. Ground Pin Current vs. Input Voltage

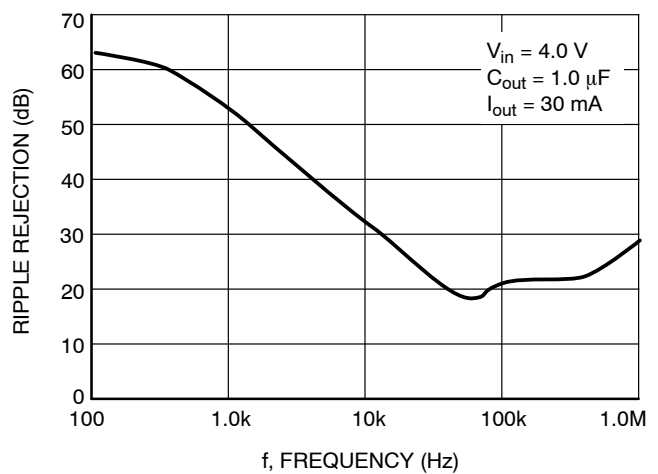

Figure 7. Ripple Rejection vs. Frequency

TYPICAL CHARACTERISTICS

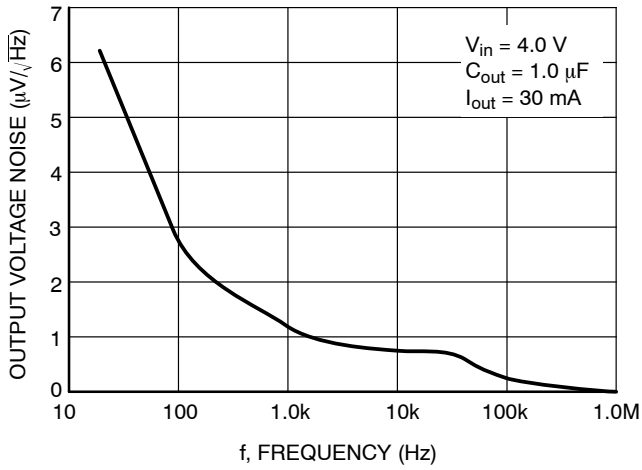

Figure 8. Output Noise Density

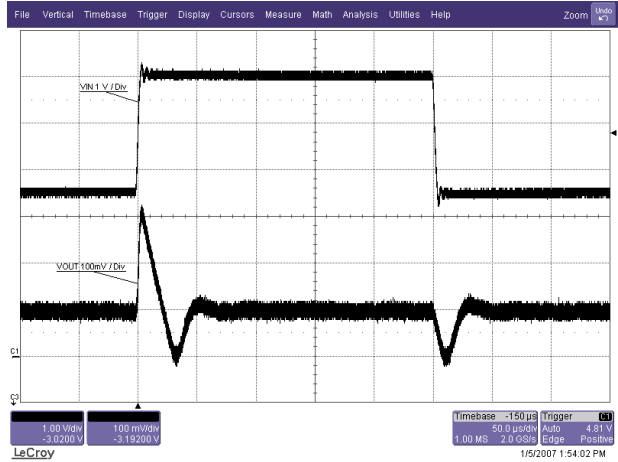

Figure 9. Line Transient Response

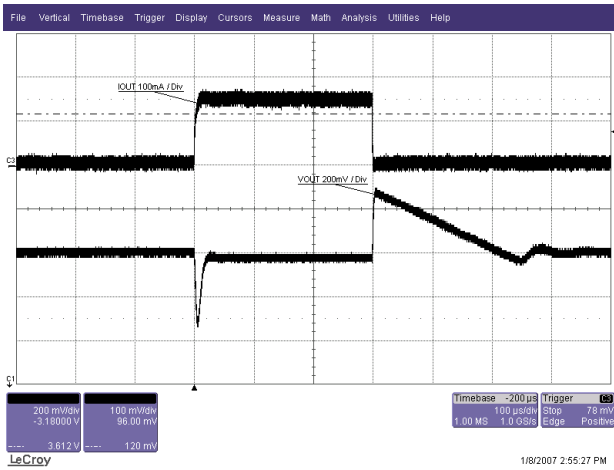

Figure 10. Load Transient Response

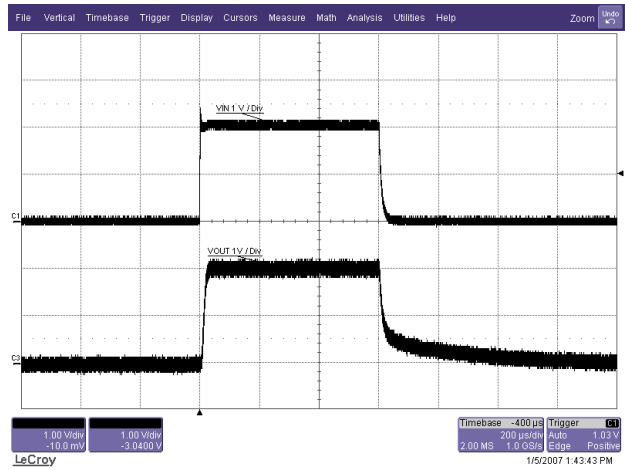

Figure 11. Turn-on Response

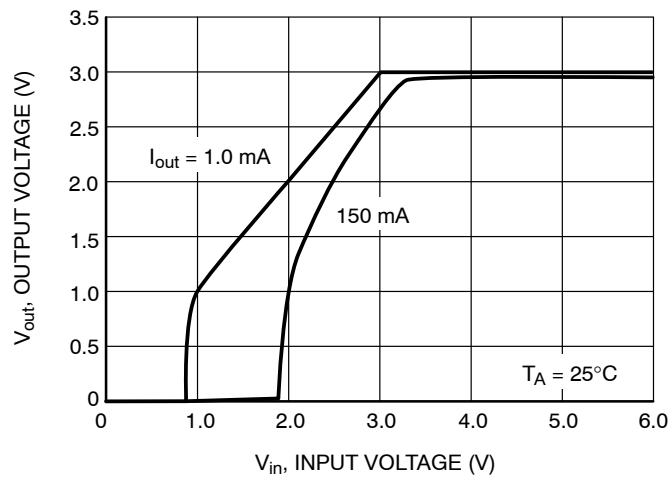

Figure 12. Output Voltage vs. Input Voltage

DEFINITIONS

Load Regulation

The change in output voltage for a change in output current at a constant temperature.

Dropout Voltage

The input/output differential at which the regulator output no longer maintains regulation against further reductions in input voltage. Measured when the output drops 3.0% below its nominal. The junction temperature, load current, and minimum input supply requirements affect the dropout level.

Maximum Power Dissipation

The maximum total dissipation for which the regulator will operate within its specifications.

Quiescent and Ground Current

The quiescent current is the current which flows through the ground when the LDO operates without a load on its output: internal IC operation, bias, etc. When the LDO becomes loaded, this term is called the Ground current. It is actually the difference between the input current (measured through the LDO input pin) and the output current.

Line Regulation

The change in output voltage for a change in input voltage. The measurement is made under conditions of low dissipation or by using pulse technique such that the average chip temperature is not significantly affected.

Line Transient Response

Typical over and undershoot response when input voltage is excited with a given slope.

Thermal Protection

Internal thermal shutdown circuitry is provided to protect the integrated circuit in the event that the maximum junction temperature is exceeded. When activated at typically 160°C, the regulator turns off. This feature is provided to prevent failures from accidental overheating.

Maximum Package Power Dissipation

The maximum power package dissipation is the power dissipation level at which the junction temperature reaches its maximum operating value, i.e. 125°C. Depending on the ambient power dissipation and thus the maximum available output current.

NCP699

APPLICATIONS INFORMATION

A typical application circuit for the NCP699 series is shown in Figure 1, front page.

Input Decoupling (C_{in})

A 1.0 μ F capacitor either ceramic or tantalum is recommended and should be connected close to the NCP699 package. Higher values and lower ESR will improve the overall line transient response.

TDK capacitor: C2012X5R1C105K, or C1608X5R1A105K

Output Decoupling (C_{out})

The NCP699 is a stable regulator and does not require any specific Equivalent Series Resistance (ESR) or a minimum output current. Capacitors exhibiting ESRs ranging from a few $m\Omega$ up to 5.0 Ω can thus safely be used. The minimum decoupling value is 1.0 μ F and can be augmented to fulfill stringent load transient requirements. The regulator accepts ceramic chip capacitors as well as tantalum capacitors. Larger values improve noise rejection and load regulation transient response.

TDK capacitor: C2012X5R1C105K, C1608X5R1A105K, or C3216X7R1C105K

Enable Operation

The enable pin will turn on the regulator when pulled high and turn off the regulator when pulled low. These limits of threshold are covered in the electrical specification section of this data sheet. If the enable is not used then the pin should be connected to V_{in} .

Hints

Please be sure the V_{in} and Gnd lines are sufficiently wide. When the impedance of these lines is high, there is a chance to pick up noise or cause the regulator to malfunction.

Set external components, especially the output capacitor, as close as possible to the circuit, and make leads as short as possible.

Thermal

As power across the NCP699 increases, it might become necessary to provide some thermal relief. The maximum power dissipation supported by the device is dependent upon board design and layout. Mounting pad configuration on the PCB, the board material and also the ambient temperature effect the rate of temperature rise for the part. This is stating that when the NCP699 has good thermal conductivity through the PCB, the junction temperature will be relatively low with high power dissipation applications.

The maximum dissipation the package can handle is given by:

$$PD = \frac{T_J(max) - T_A}{R_{\theta JA}}$$

If junction temperature is not allowed above the maximum 125°C, then the NCP699 can dissipate up to 400 mW @ 25°C.

The power dissipated by the NCP699 can be calculated from the following equation:

$$P_{tot} = [V_{in} * I_{gnd} (@I_{out})] + [V_{in} - V_{out}] * I_{out}$$

or

$$V_{inMAX} = \frac{P_{tot} + V_{out} * I_{out}}{I_{gnd}(@I_{out}) + I_{out}}$$

If an 150 mA output current is needed then the ground current from the data sheet is 40 μ A. For an NCP699 (3.0 V), the maximum input voltage will then be 5.65 V.

ORDERING INFORMATION

Device	Nominal Output Voltage*	Marking	Package	Shipping†
NCP699SN13T1G	1.3	LJY	TSOP-5 (Pb-Free)	3000 Units/ 7" Tape & Reel
NCP699SN14T1G	1.4	AA4		
NCP699SN15T1G	1.5	LJP		
NCP699SN18T1G	1.8	LJS		
NCP699SN25T1G	2.5	LJT		
NCP699SN28T1G	2.8	LJU		
NCP699SN29T1G	2.9	ACP		
NCP699SN30T1G	3.0	LJV		
NCP699SN31T1G	3.1	AAE		
NCP699SN33T1G	3.3	LJW		
NCP699SN34T1G	3.4	ACF		
NCP699SN45T1G	4.5	ACQ		
NCP699SN50T1G	5.0	LJX		

*Additional voltages in 100 mV steps are available upon request by contacting your ON Semiconductor representative.

†For information on tape and reel specifications, including part orientation and tape sizes, please refer to our Tape and Reel Packaging Specification Brochure, BRD8011/D.

MECHANICAL CASE OUTLINE PACKAGE DIMENSIONS

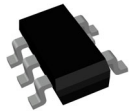

TSOP-5 3.00x1.50x0.95, 0.95P CASE 483 ISSUE P

DATE 01 APR 2024

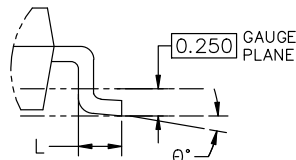
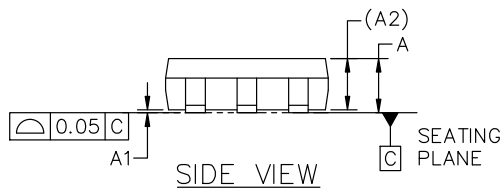
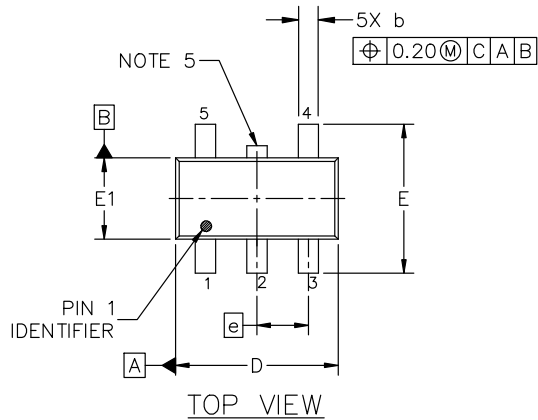

NOTES:

1. DIMENSIONING AND TOLERANCING CONFORM TO ASME Y14.5-2018.
2. ALL DIMENSION ARE IN MILLIMETERS (ANGLES IN DEGREES).
3. MAXIMUM LEAD THICKNESS INCLUDES LEAD FINISH THICKNESS. MINIMUM LEAD THICKNESS IS THE MINIMUM THICKNESS OF BASE MATERIAL.
4. DIMENSIONS D AND E1 DO NOT INCLUDE MOLD FLASH, PROTRUSIONS OF GATE BURRS. MOLD FLASH, PROTRUSIONS, OR GATE BURRS SHALL NOT EXCEED 0.15 PER SIDE. DIMENSION D.
5. OPTIONAL CONSTRUCTION: AN ADDITIONAL TRIMMED LEAD IS ALLOWED IN THIS LOCATION. TRIMMED LEAD NOT TO EXTEND MORE THAN 0.2 FROM BODY.

DIM	MILLIMETERS		
	MIN.	NOM.	MAX.
A	0.900	1.000	1.100
A1	0.010	0.055	0.100
A2	0.950 REF.		
b	0.250	0.375	0.500
c	0.100	0.180	0.260
D	2.850	3.000	3.150
E	2.500	2.750	3.000
E1	1.350	1.500	1.650
e	0.950 BSC		
L	0.200	0.400	0.600
θ	0°	5°	10°

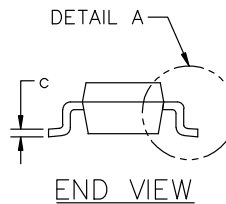

GENERIC MARKING DIAGRAM*

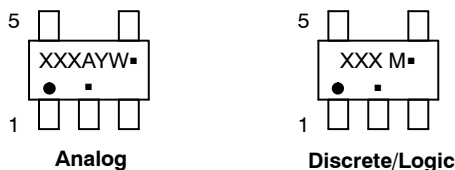

- XXX = Specific Device Code XXX = Specific Device Code
 A = Assembly Location M = Date Code
 Y = Year ▪ = Pb-Free Package
 W = Work Week

▪ = Pb-Free Package

(Note: Microdot may be in either location)

*This information is generic. Please refer to device data sheet for actual part marking. Pb-Free indicator, "G" or microdot "▪", may or may not be present. Some products may not follow the Generic Marking.

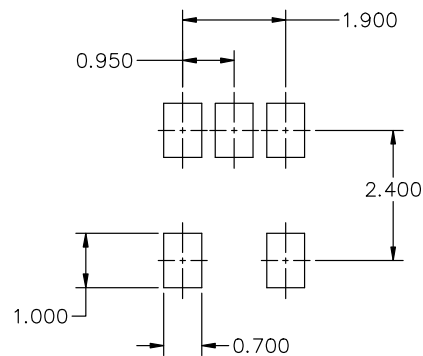

* FOR ADDITIONAL INFORMATION ON OUR Pb-FREE STRATEGY AND SOLDERING DETAILS, PLEASE DOWNLOAD THE ON SEMICONDUCTOR SOLDERING AND MOUNTING TECHNIQUES REFERENCE MANUAL, SOLDERM/D.

DOCUMENT NUMBER:	98ARB18753C	Electronic versions are uncontrolled except when accessed directly from the Document Repository. Printed versions are uncontrolled except when stamped "CONTROLLED COPY" in red.
DESCRIPTION:	TSOP-5 3.00x1.50x0.95, 0.95P	PAGE 1 OF 1

onsemi and ONSEMI are trademarks of Semiconductor Components Industries, LLC dba onsemi or its subsidiaries in the United States and/or other countries. onsemi reserves the right to make changes without further notice to any products herein. onsemi makes no warranty, representation or guarantee regarding the suitability of its products for any particular purpose, nor does onsemi assume any liability arising out of the application or use of any product or circuit, and specifically disclaims any and all liability, including without limitation special, consequential or incidental damages. onsemi does not convey any license under its patent rights nor the rights of others.

onsemi, **Onsemi**, and other names, marks, and brands are registered and/or common law trademarks of Semiconductor Components Industries, LLC dba "**onsemi**" or its affiliates and/or subsidiaries in the United States and/or other countries. **onsemi** owns the rights to a number of patents, trademarks, copyrights, trade secrets, and other intellectual property. A listing of **onsemi**'s product/patent coverage may be accessed at www.onsemi.com/site/pdf/Patent-Marking.pdf. **onsemi** reserves the right to make changes at any time to any products or information herein, without notice. The information herein is provided "as-is" and **onsemi** makes no warranty, representation or guarantee regarding the accuracy of the information, product features, availability, functionality, or suitability of its products for any particular purpose, nor does **onsemi** assume any liability arising out of the application or use of any product or circuit, and specifically disclaims any and all liability, including without limitation special, consequential or incidental damages. Buyer is responsible for its products and applications using **onsemi** products, including compliance with all laws, regulations and safety requirements or standards, regardless of any support or applications information provided by **onsemi**. "Typical" parameters which may be provided in **onsemi** data sheets and/or specifications can and do vary in different applications and actual performance may vary over time. All operating parameters, including "Typicals" must be validated for each customer application by customer's technical experts. **onsemi** does not convey any license under any of its intellectual property rights nor the rights of others. **onsemi** products are not designed, intended, or authorized for use as a critical component in life support systems or any FDA Class 3 medical devices or medical devices with a same or similar classification in a foreign jurisdiction or any devices intended for implantation in the human body. Should Buyer purchase or use **onsemi** products for any such unintended or unauthorized application, Buyer shall indemnify and hold **onsemi** and its officers, employees, subsidiaries, affiliates, and distributors harmless against all claims, costs, damages, and expenses, and reasonable attorney fees arising out of, directly or indirectly, any claim of personal injury or death associated with such unintended or unauthorized use, even if such claim alleges that **onsemi** was negligent regarding the design or manufacture of the part. **onsemi** is an Equal Opportunity/Affirmative Action Employer. This literature is subject to all applicable copyright laws and is not for resale in any manner.

ADDITIONAL INFORMATION

TECHNICAL PUBLICATIONS:

Technical Library: www.onsemi.com/design/resources/technical-documentation
onsemi Website: www.onsemi.com

ONLINE SUPPORT: www.onsemi.com/support

For additional information, please contact your local Sales Representative at www.onsemi.com/support/sales