

Integrated Load Switch

FDC6331L



TSOT-23-6
CASE 419BL

Description

This device is particularly suited for compact power management in portable electronic equipment where 2.5 V to 8 V input and 2.8 A output current capability are needed. This load switch integrates a small N-Channel power MOSFET (Q1) that drives a large P-Channel power MOSFET (Q2) in one tiny SUPERSOT™-6 package.

Features

- -2.8 A, -8 V
 - ♦ $R_{DS(on)} = 55\text{ m}\Omega @ V_{GS} = -4.5\text{ V}$
 - ♦ $R_{DS(on)} = 70\text{ m}\Omega @ V_{GS} = -2.5\text{ V}$
 - ♦ $R_{DS(on)} = 100\text{ m}\Omega @ V_{GS} = -1.8\text{ V}$
- Control MOSFET (Q1) Includes Zener Protection for ESD Ruggedness (>6 kV Human Body Model)
- High Performance Trench Technology for Extremely Low $R_{DS(on)}$
- This is a Pb-Free and Halide Free Device

Applications

- Load Switch
- Power Management

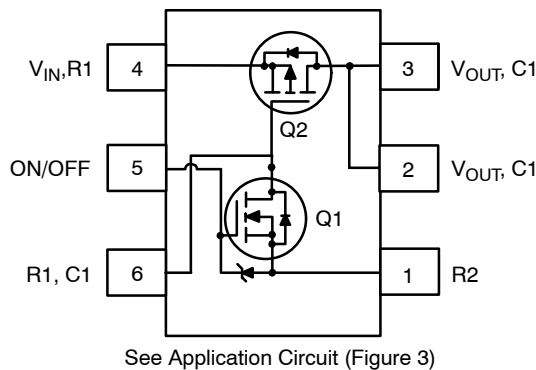

Figure 1.

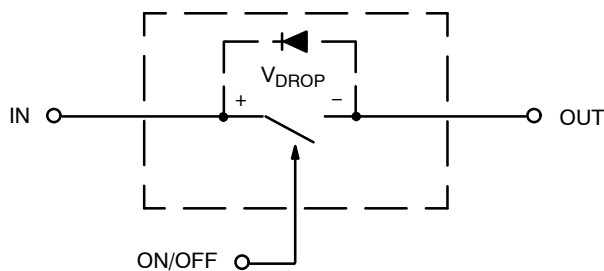
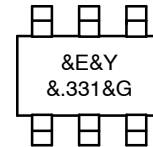

Figure 2. Equivalent Circuit

MARKING DIAGRAM



- &E = Designates Space
- &Y = Binary Calendar Year Coding Scheme
- &. = Pin One Dot
- 331 = Specific Device Code
- &G = Date Code

ORDERING INFORMATION

Device	Package	Shipping†
FDC6331L	TSOT-23-6 (Pb-Free)	3000 / Tape & Reel

†For information on tape and reel specifications, including part orientation and tape sizes, please refer to our Tape and Reel Packaging Specification Brochure, BRD8011/D.

FDC6331L

ABSOLUTE MAXIMUM RATINGS $T_A = 25^\circ\text{C}$ unless otherwise noted

Symbol	Parameter	Value	Unit
V_{IN}	Maximum Input Voltage	± 8	V
$V_{ON/OFF}$	High Level On/Off Voltage Range	-0.5 to 8	V
I_{Load}	Load Current – Continuous (Note 1)	2.8	A
	Load Current – Pulsed	9	
P_D	Maximum Power Dissipation (Note 1)	0.7	W
T_J, T_{STG}	Operating and Storage Junction Temperature Range	-55 to 150	$^\circ\text{C}$

Stresses exceeding those listed in the Maximum Ratings table may damage the device. If any of these limits are exceeded, device functionality should not be assumed, damage may occur and reliability may be affected.

THERMAL CHARACTERISTICS $T_A = 25^\circ\text{C}$ unless otherwise noted

Symbol	Parameter	Value	Unit
$R_{\theta JA}$	Thermal Resistance, Junction-to-Ambient (Note 1)	180	$^\circ\text{C}/\text{W}$
$R_{\theta JC}$	Thermal Resistance, Junction-to-Case (Note 1)	60	$^\circ\text{C}/\text{W}$

ELECTRICAL CHARACTERISTICS $T_A = 25^\circ\text{C}$ unless otherwise noted

Symbol	Parameter	Test Conditions	Min	Typ	Max	Unit
--------	-----------	-----------------	-----	-----	-----	------

OFF CHARACTERISTICS

BV_{IN}	V_{IN} Breakdown Voltage	$V_{ON/OFF} = 0\text{ V}, I_D = -250\ \mu\text{A}$	8	-	-	V
I_{Load}	Zero Gate Voltage Drain Current	$V_{IN} = 6.4\text{ V}, V_{ON/OFF} = 0\text{ V}$	-	-	-1	μA
I_{FL}	Leakage Current, Forward	$V_{ON/OFF} = 0\text{ V}, V_{IN} = 8\text{ V}$	-	-	-100	nA
I_{RL}	Leakage Current, Reverse	$V_{ON/OFF} = 0\text{ V}, V_{IN} = -8\text{ V}$	-	-	100	nA

ON CHARACTERISTICS (Note 2)

$V_{ON/OFF(th)}$	Gate Threshold Voltage	$V_{IN} = V_{ON/OFF}, I_D = -250\ \mu\text{A}$	0.4	0.9	1.5	V
$R_{DS(on)}$	Static Drain-Source On-Resistance (Q2)	$V_{GS} = -4.5\text{ V}, I_D = -2.8\text{ A}$	-	34	55	m Ω
		$V_{GS} = -2.5\text{ V}, I_D = -2.5\text{ A}$	-	45	70	
		$V_{GS} = -1.8\text{ V}, I_D = -2.0\text{ A}$	-	64	100	
$R_{DS(on)}$	Static Drain-Source On-Resistance (Q1)	$V_{GS} = 4.5\text{ V}, I_D = 0.4\text{ A}$	-	3.1	4	Ω
		$V_{GS} = 2.7\text{ V}, I_D = 0.2\text{ A}$	-	3.8	5	

DRAIN-SOURCE DIODE CHARACTERISTICS AND MAXIMUM RATINGS

I_S	Maximum Continuous Drain-Source Diode Forward Current		-	-	-0.6	A
V_{SD}	Drain-Source Diode Forward Voltage	$V_{ON/OFF} = 0\text{ V}, I_S = -0.6\text{ A}$ (Note 2)	-	-	-1.2	V

Product parametric performance is indicated in the Electrical Characteristics for the listed test conditions, unless otherwise noted. Product performance may not be indicated by the Electrical Characteristics if operated under different conditions.

NOTES:

- $R_{\theta JA}$ is the sum of the junction-to-case and case-to-ambient thermal resistance where the case thermal reference is defined as the solder mounting surface of the drain pins. $R_{\theta JC}$ is guaranteed by design while $R_{\theta JA}$ is determined by the user's board design.
- Pulse Test: Pulse Width < 300 μs , Duty Cycle < 2.0%.

FDC6331L

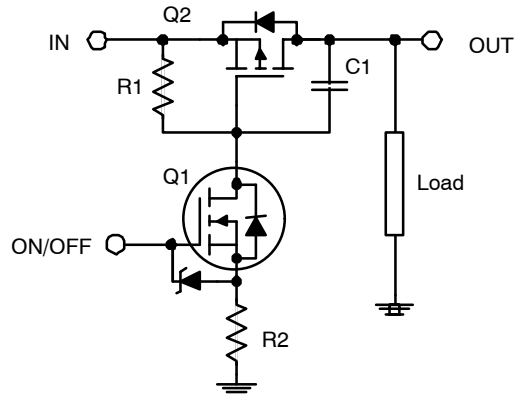

Figure 3. FDC6331L Load Switch Application Circuit

External Component Recommendation:

For additional in-rush current control, R2 and C1 can be added. For more information, see application note AN1030.

TYPICAL CHARACTERISTICS

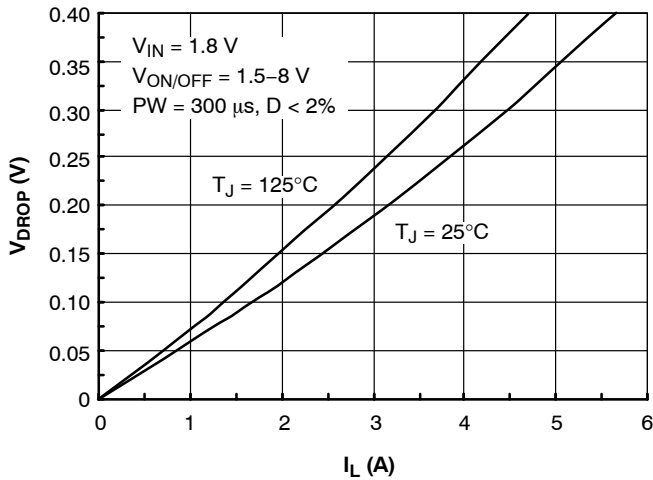

Figure 4. Conduction Voltage Drop Variation with Load Current

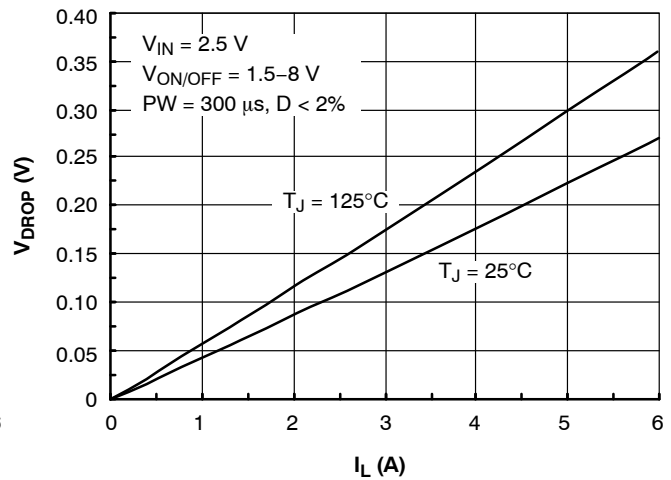

Figure 5. Conduction Voltage Drop Variation with Load Current

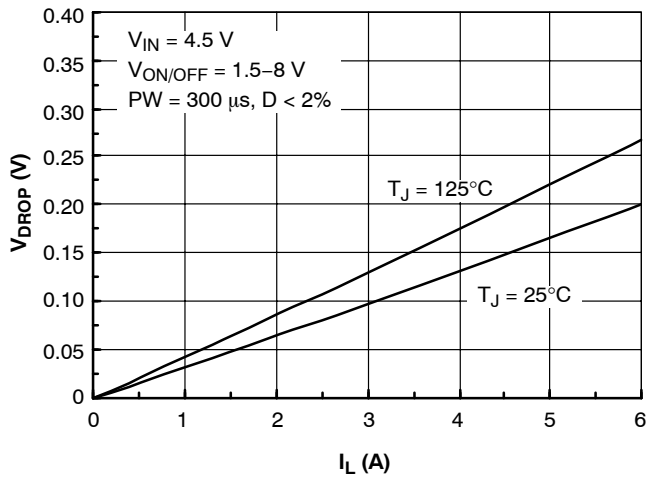

Figure 6. Conduction Voltage Drop Variation with Load Current

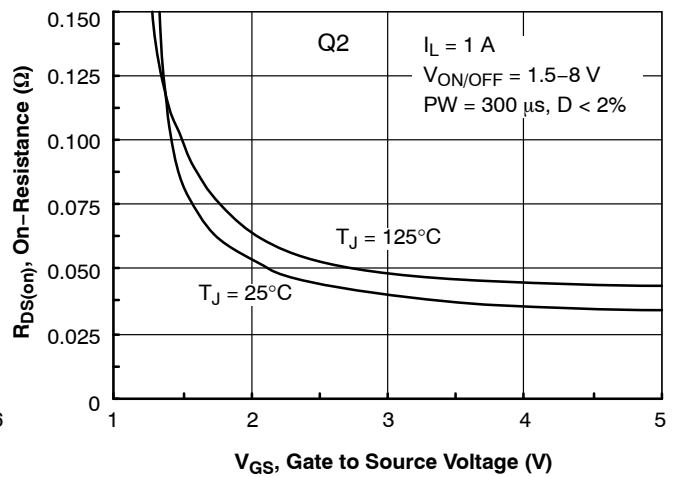

Figure 7. On-Resistance Variation with Input Voltage

FDC6331L

TYPICAL CHARACTERISTICS (continued)

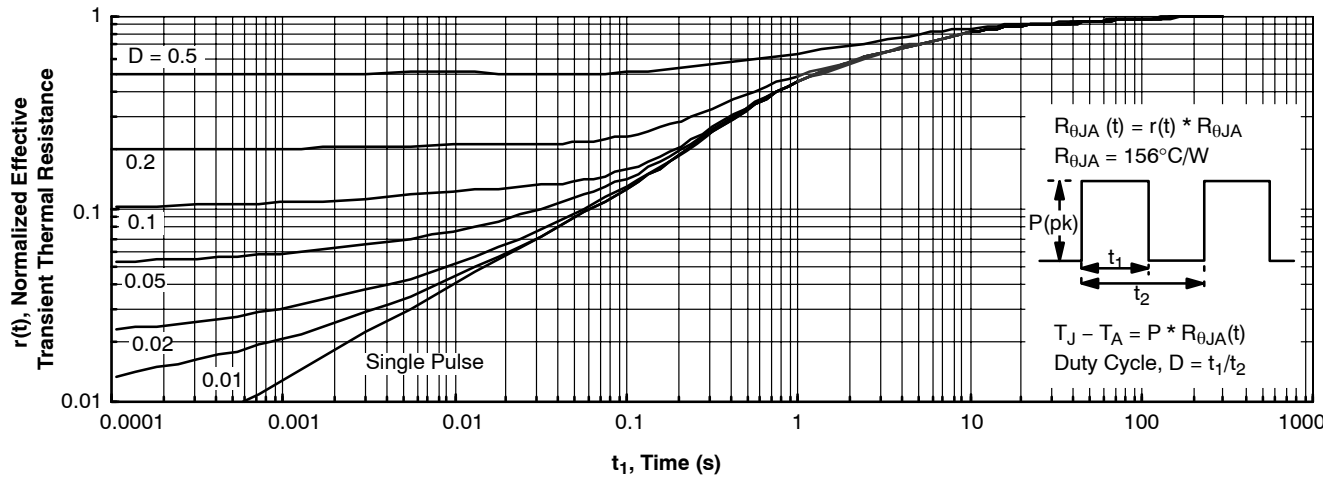

Figure 8. Transient Thermal Response Curve

NOTE: Thermal characterization performed on the conditions described in Note 2.
 Transient thermal response will change depends on the circuit board design.

SUPERSOT is a trademark of Semiconductor Components Industries, LLC dba "onsemi" or its affiliates and/or subsidiaries in the United States and/or other countries.



1
SCALE 2:1

TSOT23 6-Lead
CASE 419BL
ISSUE A

DATE 31 AUG 2020

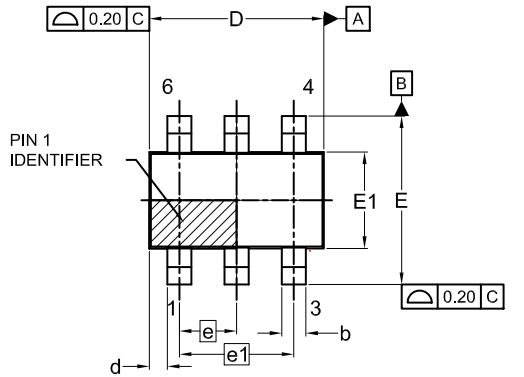

TOP VIEW

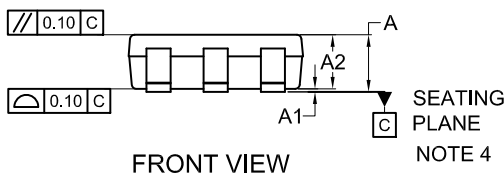

FRONT VIEW

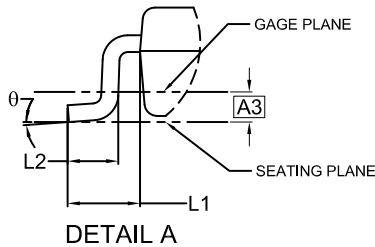

DETAIL A

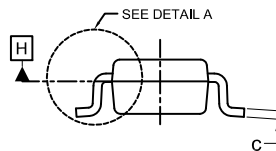

SIDE VIEW

SYMM
⌀

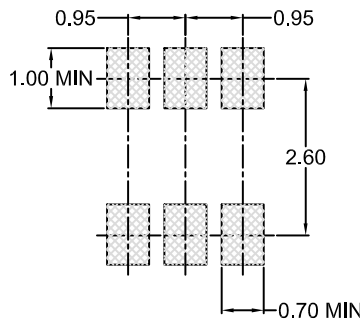

LAND PATTERN
RECOMMENDATION

*FOR ADDITIONAL INFORMATION ON OUR
Pb-FREE STRATEGY AND SOLDERING DETAILS,
PLEASE DOWNLOAD THE ON SEMICONDUCTOR
SOLDERING AND MOUNTING TECHNIQUES
REFERENCE MANUAL, SOLDERRM/D.

NOTES:

1. DIMENSIONING AND TOLERANCING PER ASME Y14.5M, 2009.
2. CONTROLLING DIMENSION: MILLIMETERS
3. DIMENSIONS D AND E1 DO NOT INCLUDE MOLD FLASH, PROTRUSIONS, OR GATE BURRS. MOLD FLASH, PROTRUSIONS OR GATE BURRS SHALL NOT EXCEED 0.25MM PER END. DIMENSIONS D AND E1 ARE DETERMINED AT DATUM H.
4. SEATING PLANE IS DEFINED BY THE TERMINALS. "A1" IS DEFINED AS THE DISTANCE FROM THE SEATING PLANE TO THE LOWEST POINT ON THE PACKAGE BODY.

DIM	MILLIMETERS		
	MIN.	NOM.	MAX.
A	0.90	1.00	1.10
A1	0.00	0.05	0.10
A2	0.70	0.85	1.00
A3	0.25 BSC		
b	0.25	0.38	0.50
c	0.10	0.18	0.26
D	2.80	2.95	3.10
d	0.30 REF		
E	2.50	2.75	3.00
E1	1.30	1.50	1.70
e	0.95 BSC		
e1	1.90 BSC		
L1	0.60 REF		
L2	0.20	0.40	0.60
⊖	0°	--	10°

GENERIC
MARKING DIAGRAM*

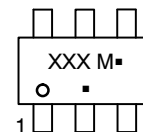

- XXX = Specific Device Code
- M = Date Code
- = Pb-Free Package

(Note: Microdot may be in either location)

*This information is generic. Please refer to device data sheet for actual part marking. Pb-Free indicator, "G" or microdot "▪", may or may not be present. Some products may not follow the Generic Marking.

DOCUMENT NUMBER:	98AON83292G	Electronic versions are uncontrolled except when accessed directly from the Document Repository. Printed versions are uncontrolled except when stamped "CONTROLLED COPY" in red.
DESCRIPTION:	TSOT23 6-Lead	PAGE 1 OF 1

onsemi and Onsemi are trademarks of Semiconductor Components Industries, LLC dba onsemi or its subsidiaries in the United States and/or other countries. onsemi reserves the right to make changes without further notice to any products herein. onsemi makes no warranty, representation or guarantee regarding the suitability of its products for any particular purpose, nor does onsemi assume any liability arising out of the application or use of any product or circuit, and specifically disclaims any and all liability, including without limitation special, consequential or incidental damages. onsemi does not convey any license under its patent rights nor the rights of others.

onsemi, **Onsemi**, and other names, marks, and brands are registered and/or common law trademarks of Semiconductor Components Industries, LLC dba "**onsemi**" or its affiliates and/or subsidiaries in the United States and/or other countries. **onsemi** owns the rights to a number of patents, trademarks, copyrights, trade secrets, and other intellectual property. A listing of **onsemi**'s product/patent coverage may be accessed at www.onsemi.com/site/pdf/Patent-Marking.pdf. **onsemi** reserves the right to make changes at any time to any products or information herein, without notice. The information herein is provided "as-is" and **onsemi** makes no warranty, representation or guarantee regarding the accuracy of the information, product features, availability, functionality, or suitability of its products for any particular purpose, nor does **onsemi** assume any liability arising out of the application or use of any product or circuit, and specifically disclaims any and all liability, including without limitation special, consequential or incidental damages. Buyer is responsible for its products and applications using **onsemi** products, including compliance with all laws, regulations and safety requirements or standards, regardless of any support or applications information provided by **onsemi**. "Typical" parameters which may be provided in **onsemi** data sheets and/or specifications can and do vary in different applications and actual performance may vary over time. All operating parameters, including "Typicals" must be validated for each customer application by customer's technical experts. **onsemi** does not convey any license under any of its intellectual property rights nor the rights of others. **onsemi** products are not designed, intended, or authorized for use as a critical component in life support systems or any FDA Class 3 medical devices or medical devices with a same or similar classification in a foreign jurisdiction or any devices intended for implantation in the human body. Should Buyer purchase or use **onsemi** products for any such unintended or unauthorized application, Buyer shall indemnify and hold **onsemi** and its officers, employees, subsidiaries, affiliates, and distributors harmless against all claims, costs, damages, and expenses, and reasonable attorney fees arising out of, directly or indirectly, any claim of personal injury or death associated with such unintended or unauthorized use, even if such claim alleges that **onsemi** was negligent regarding the design or manufacture of the part. **onsemi** is an Equal Opportunity/Affirmative Action Employer. This literature is subject to all applicable copyright laws and is not for resale in any manner.

ADDITIONAL INFORMATION

TECHNICAL PUBLICATIONS:

Technical Library: www.onsemi.com/design/resources/technical-documentation
onsemi Website: www.onsemi.com

ONLINE SUPPORT: www.onsemi.com/support

For additional information, please contact your local Sales Representative at www.onsemi.com/support/sales