

NCP2993

Audio Power Amplifier, 1.3 W, with Selectable Fast Turn-On Time

The NCP2993 is an audio power amplifier designed for portable communication device applications such as mobile phone applications. The NCP2993 is capable of delivering 1.3 W of continuous average power to an 8.0 Ω BTL load from a 5.0 V power supply, and 1.1 W to a 4.0 Ω BTL load from a 3.6 V power supply.

The NCP2993 provides high quality audio while requiring few external components and minimal power consumption. It features a low-power consumption shutdown mode, which is achieved by driving the SHUTDOWN pin with logic low.

The NCP2993 contains circuitry to prevent from “pop and click” noise that would otherwise occur during turn-on and turn-off transitions. It is a zero pop noise device when a single ended or a differential audio input is used.

For maximum flexibility, the NCP2993 provides an externally controlled gain (with resistors). In addition, it integrates 2 different Turn On times (15 ms or 30 ms) adjustable with the TON pin.

Due to its superior PSRR, it can be directly connected to the battery, saving the use of an LDO.

This device is available in a 9-Pin Flip-Chip CSP package with a 0.4mm pitch (Lead-Free).

Features

- 1.3 W to an 8.0 Ω BTL Load from a 5.0 V Power Supply
- Best-in-Class PSRR: up to -88 dB, Direct Connection to the Battery
- Zero Pop Noise Signature with a Single Ended Audio Input
- Ultra Low Current Shutdown Mode: 10 nA
- 2.5 V–5.5 V Operation
- External Gain Configuration Capability
- External Turn-on Time Configuration Capability: 15 ms or 30 ms
- Thermal Overload Protection Circuitry
- This is a Pb-Free Device*

Typical Applications

- Portable Electronic Devices
- PDAs
- Wireless Phones



ON Semiconductor®

<http://onsemi.com>

MARKING DIAGRAM



WLCSP9
FC SUFFIX
CASE 499BM

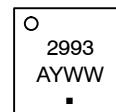

2993 = Specific Device Code
A = Assembly Location
Y = Year
WW = Work Week
▪ = Pb-Free Package

PIN CONNECTIONS

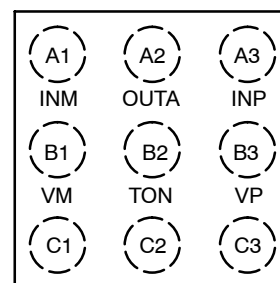

BYPASS OUTB SHUTDOWN
(Top View)

ORDERING INFORMATION

See detailed ordering and shipping information in the package dimensions section on page 11 of this data sheet.

*For additional information on our Pb-Free strategy and soldering details, please download the ON Semiconductor Soldering and Mounting Techniques Reference Manual, SOLDERRM/D.

NCP2993

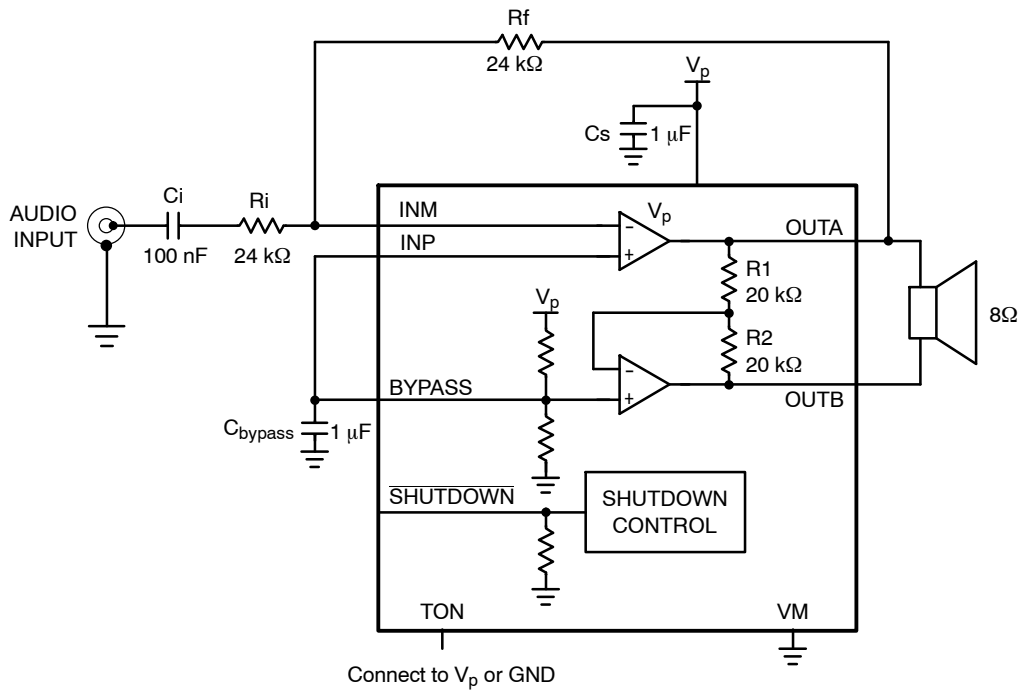

Figure 1. Typical Audio Amplifier Application Circuit with Single Ended Input

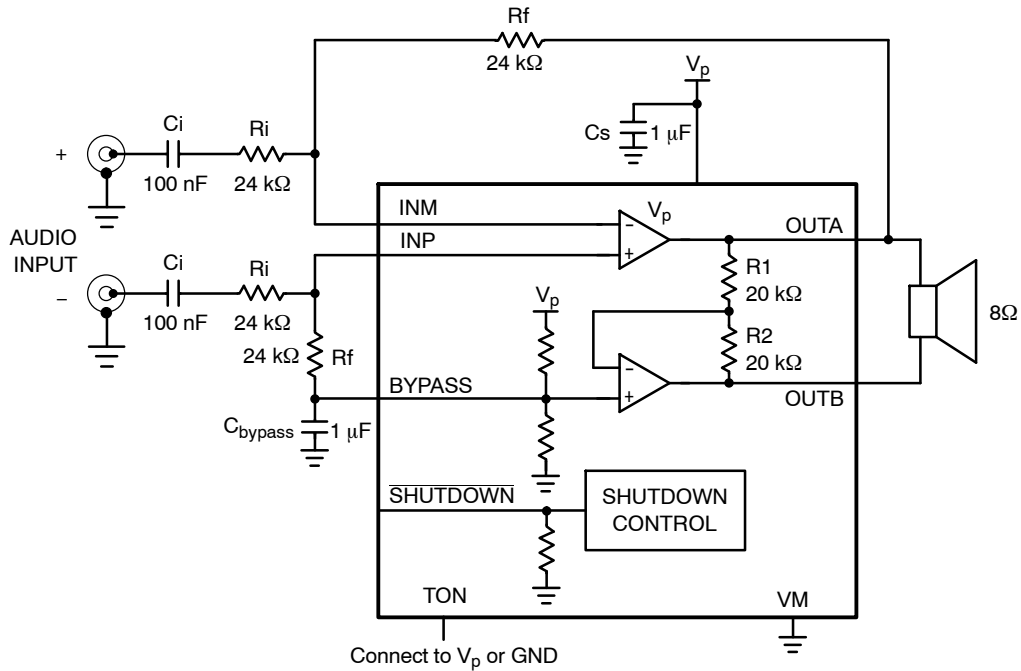

Figure 2. Typical Audio Amplifier Application Circuit with a Differential Input

NCP2993

PIN DESCRIPTION

Pin	Name	Type	Description
A1	INM	I	Negative input of the first amplifier, receives the audio input signal. Connected to the feedback resistor R_f and to the input resistor R_{in} .
A2	OUTA	O	Negative output of the NCP2993. Connected to the load and to the feedback resistor R_f .
A3	INP	I	Positive input of the first amplifier, receives the common mode voltage.
B1	VM	I	Analog Ground.
B2	TON	I	TON pin selects 2 different Turn On times: TON = GND → 30 ms TON = VP → 15 ms
B3	VP	I	Positive analog supply of the cell. Range: 2.5 V–5.5 V.
C1	BYPASS	I	Bypass capacitor pin which provides the common mode voltage ($V_p/2$).
C2	OUTB	O	Positive output of the NCP2993. Connected to the load.
C3	SHUTDOWN	I	The device enters in shutdown mode when a low level is applied on this pin.

MAXIMUM RATINGS (Note 1)

Rating	Symbol	Value	Unit
Supply Voltage	V_p	6.0	V
Operating Supply Voltage	Op V_p	2.5 to 5.5 V	–
Input Voltage	V_{in}	–0.3 to $V_{CC} + 0.3$	V
Power Dissipation (Note 2)	P_d	Internally Limited	–
Operating Ambient Temperature	T_A	–40 to +85	°C
Max Junction Temperature	T_J	150	°C
Storage Temperature Range	T_{stg}	–65 to +150	°C
Thermal Resistance Junction–to–Air	$R_{\theta JA}$	(Note 3)	°C/W
ESD Protection	Human Body Model (HBM) (Note 4)	2000	V
	Machine Model (MM) (Note 5)	200	
Latchup Current @ $T_A = 85^\circ\text{C}$ (Note 6)	–	± 100	mA

Stresses exceeding Maximum Ratings may damage the device. Maximum Ratings are stress ratings only. Functional operation above the Recommended Operating Conditions is not implied. Extended exposure to stresses above the Recommended Operating Conditions may affect device reliability.

1. Maximum electrical ratings are defined as those values beyond which damage to the device may occur at $T_A = +25^\circ\text{C}$.
2. The thermal shutdown set to 160°C (typical) avoids irreversible damage on the device due to power dissipation.
3. The $R_{\theta JA}$ is highly dependent of the PCB Heatsink area. For example, $R_{\theta JA}$ can equal 195°C/W with 50 mm^2 total area and also 135°C/W with 500 mm^2 . The bumps have the same thermal resistance and all need to be connected to optimize the power dissipation.
4. Human Body Model, 100 pF discharge through a $1.5\text{ k}\Omega$ resistor following specification JESD22/A114.
5. Machine Model, 200 pF discharged through all pins following specification JESD22/A115.

NCP2993

ELECTRICAL CHARACTERISTICS Limits apply for T_A between -40°C to $+85^{\circ}\text{C}$ (Unless otherwise noted).

Characteristic	Symbol	Conditions	Min (Note 6)	Typ	Max (Note 6)	Unit	
Supply Quiescent Current	I_{dd}	$V_p = 2.5\text{ V}$, No Load	-	1.8	3.5	mA	
		$V_p = 5.0\text{ V}$, No Load	-	1.95			
		$V_p = 2.5\text{ V}$, $8\ \Omega$ $V_p = 5.0\text{ V}$, $8\ \Omega$	-	1.8 1.95	3.5		
Common Mode Voltage	V_{cm}	-	-	$V_p/2$	-	V	
Shutdown Current	I_{SD}	-	-	0.02	0.5	μA	
Shutdown Pull-Down	R_{SD}	-	-	300	-	k Ω	
Shutdown Voltage High	V_{SDIH}	-	1.2	-	-	V	
Shutdown Voltage Low	V_{SDIL}	-	-	-	0.4	V	
Turn On Time (Note 8)	T_{WU}	TON = GND	-	30	-	ms	
		TON = VP	-	15			
Turn Off Time	T_{OFF}	-	-	1.0	-	μs	
Output Impedance in Shutdown Mode	Z_{SD}	-	-	8.5	-	k Ω	
Output Swing	$V_{loadpeak}$	$V_p = 2.5\text{ V}$, $R_L = 8.0\ \Omega$	1.9	2.3	-	V	
		$V_p = 5.0\text{ V}$, $R_L = 8.0\ \Omega$ (Note 7) $T_A = +25^{\circ}\text{C}$	3.8	4.6	-		
RMS Output Power	P_O	$V_p = 2.5\text{ V}$, $R_L = 4.0\ \Omega$ THD + N < 1%	-	0.5	-	W	
		$V_p = 2.5\text{ V}$, $R_L = 8.0\ \Omega$ THD + N < 1%	-	0.32	-		
		$V_p = 5.0\text{ V}$, $R_L = 8.0\ \Omega$ THD + N < 1%	-	1.3	-		
Maximum Power Dissipation (Note 8)	P_{Dmax}	$V_p = 5.0\text{ V}$, $R_L = 8.0\ \Omega$	-	-	0.65	W	
Output Offset Voltage	V_{OS}	$V_p = 2.5\text{ V}$ $V_p = 5.0\text{ V}$	-	1.0	-	mV	
Signal-to-Noise Ratio	SNR	$V_p = 2.5\text{ V}$, $G = 2.0$ 20 Hz < F < 20 kHz	-	91	-	dB	
Positive Supply Rejection Ratio	PSRR V+	$G = 2.0$, $R_L = 8.0\ \Omega$ $C_{by} = 1.0\ \mu\text{F}$ Input Grounded F = 217 Hz	-	-88	-	dB	
			$V_p = 5.0\text{ V}$	-	-88		-
			$V_p = 4.2\text{ V}$	-	-88		-
		$V_p = 3.0\text{ V}$	-	-88	-		
		F = 1.0 kHz	-	-88	-		
			$V_p = 5.0\text{ V}$	-	-88		-
$V_p = 4.2\text{ V}$	-		-88	-			
Efficiency	η	$V_p = 2.5\text{ V}$, $P_{orms} = 320\text{ mW}$	-	70	-	%	
		$V_p = 5.0\text{ V}$, $P_{orms} = 1.0\text{ W}$	-	60	-		
Thermal Shutdown Temperature	T_{sd}	-	-	160	-	$^{\circ}\text{C}$	
Total Harmonic Distortion	THD	$V_p = 2.5\text{ V}$, F = 1.0 kHz $R_L = 4.0\ \Omega$, $A_V = 2.0$ $P_O = 0.32\text{ W}$	-	-	-	%	
			-	0.015	-		
		$V_p = 5.0\text{ V}$, F = 1.0 kHz $R_L = 8.0\ \Omega$, $A_V = 2.0$ $P_O = 1.0\text{ W}$	-	-	-		
			-	0.01	-		

6. Min/Max limits are guaranteed by design, test or statistical analysis.

7. This parameter is guaranteed but not tested in production in case of a 5.0 V power supply.

8. See page 10 for a theoretical approach of this parameter.

TYPICAL CHARACTERISTICS

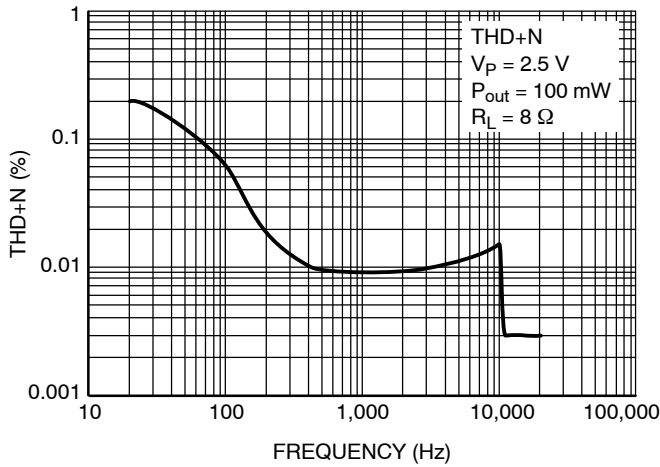

Figure 3. THD+N vs. Frequency, Single-Ended Input

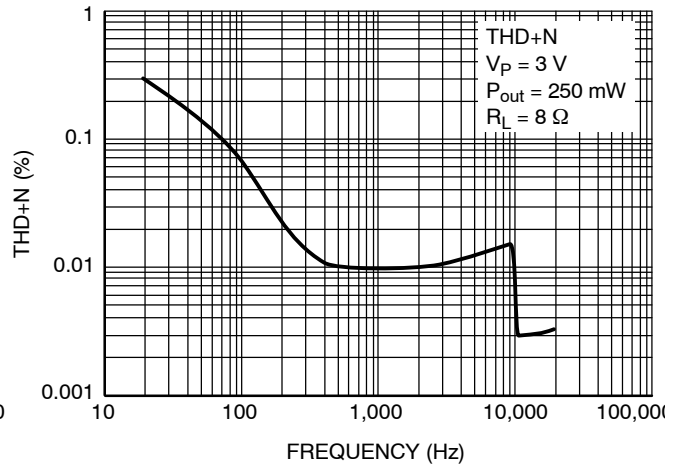

Figure 4. THD+N vs. Frequency, Single-Ended Input

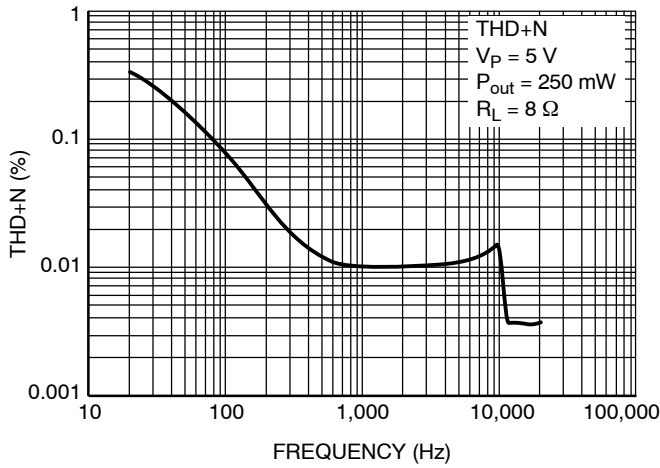

Figure 5. THD+N vs. Frequency, Single-Ended Input

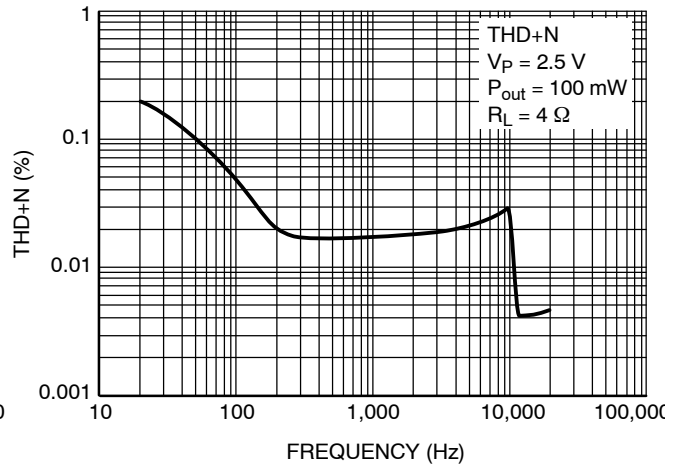

Figure 6. THD+N vs. Frequency, Single-Ended Input

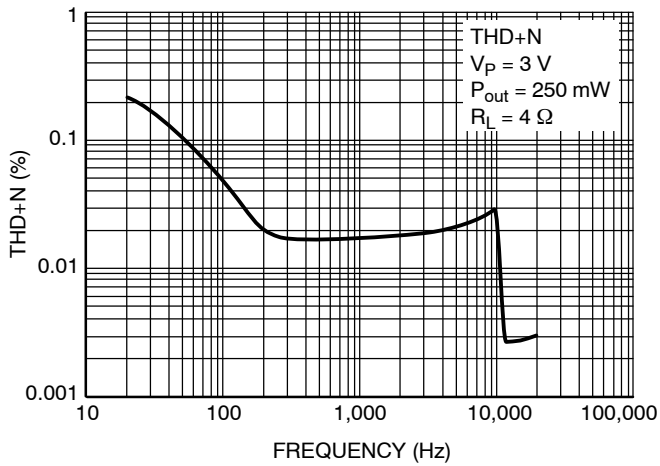

Figure 7. THD+N vs. Frequency, Single-Ended Input

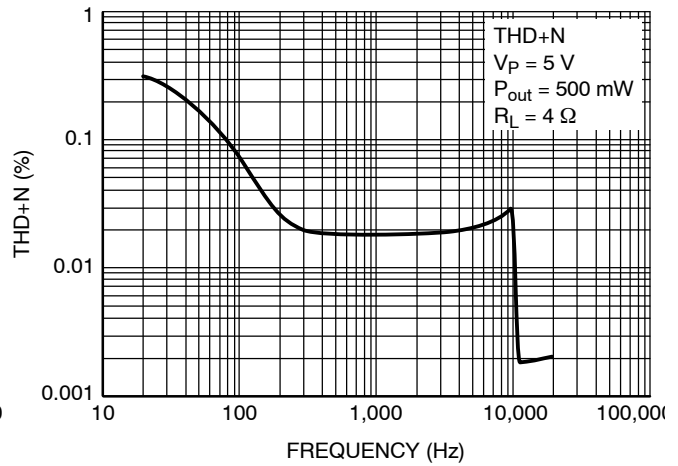

Figure 8. THD+N vs. Frequency, Single-Ended Input

TYPICAL CHARACTERISTICS

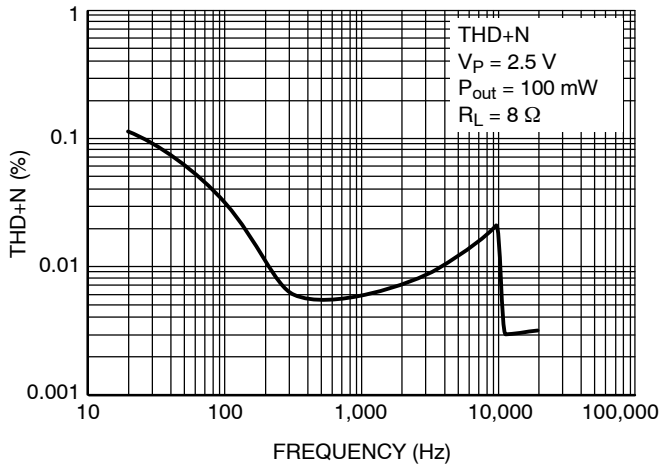

Figure 9. THD+N vs. Frequency, Differential Input

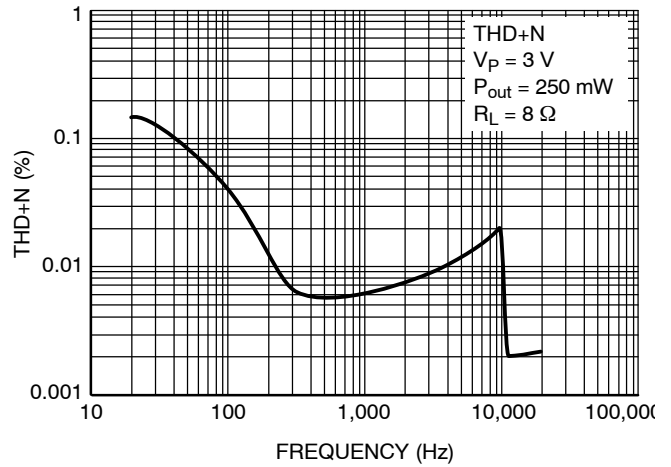

Figure 10. THD+N vs. Frequency, Differential Input

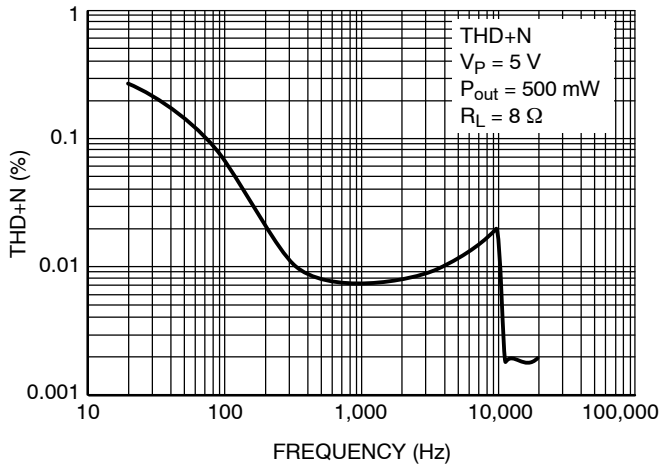

Figure 11. THD+N vs. Frequency, Differential Input

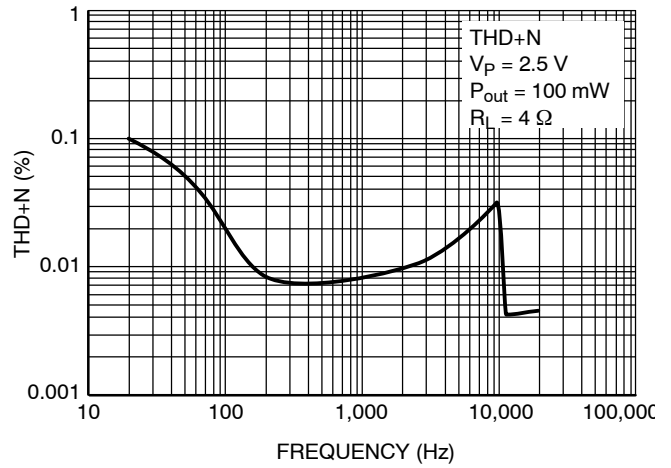

Figure 12. THD+N vs. Frequency, Differential Input

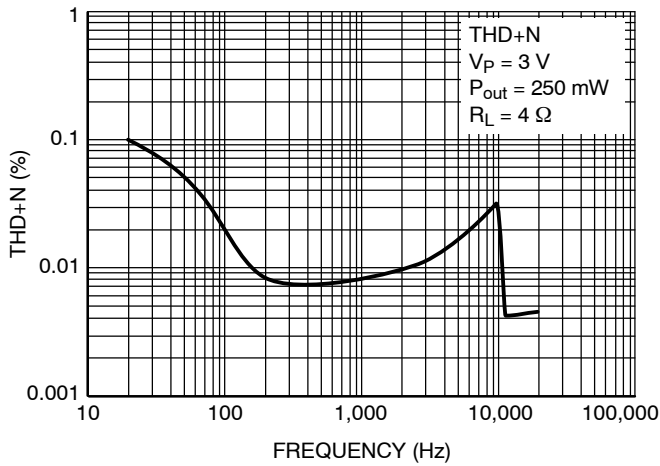

Figure 13. THD+N vs. Frequency, Differential Input

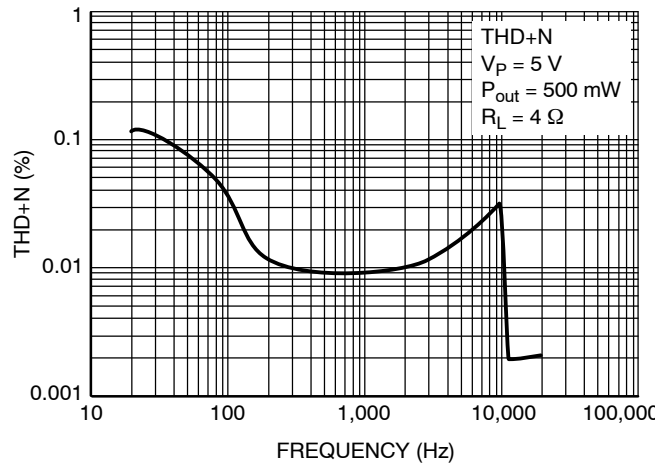

Figure 14. THD+N vs. Frequency, Differential Input

NCP2993

TYPICAL CHARACTERISTICS

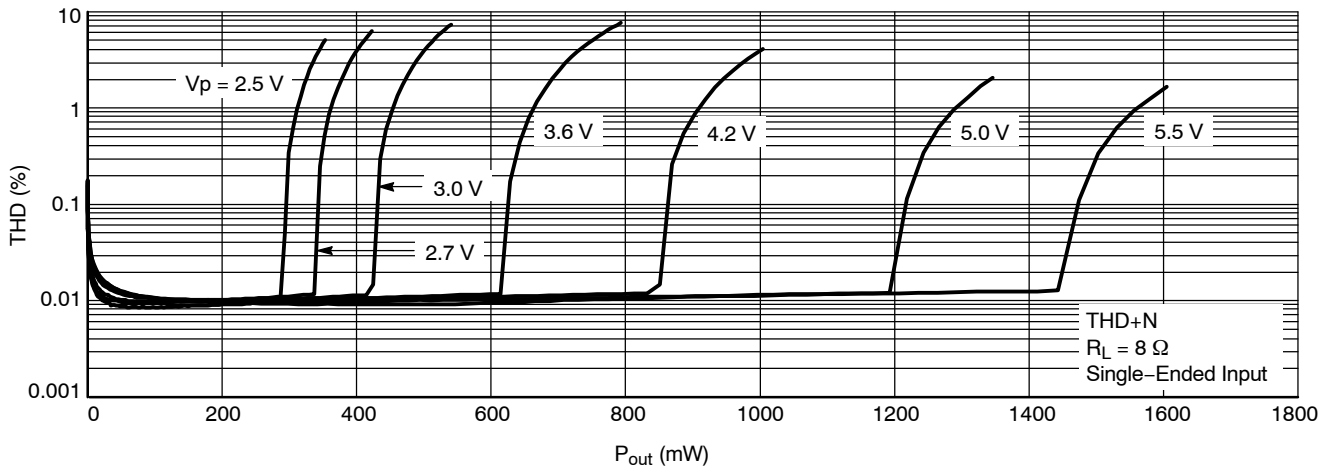

Figure 15. THD+N vs. P_{out}

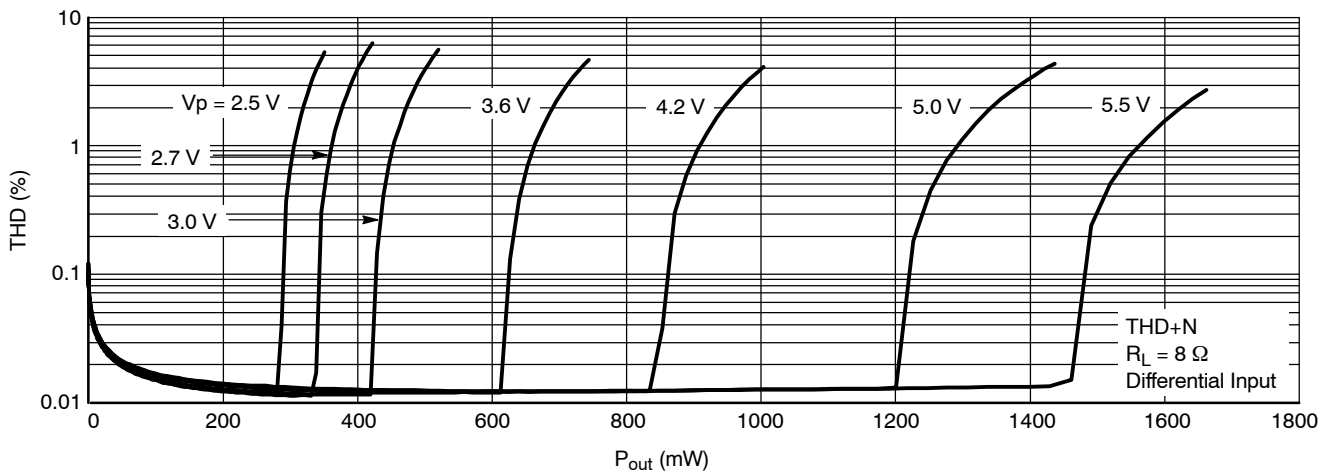

Figure 16. THD+N vs. P_{out}

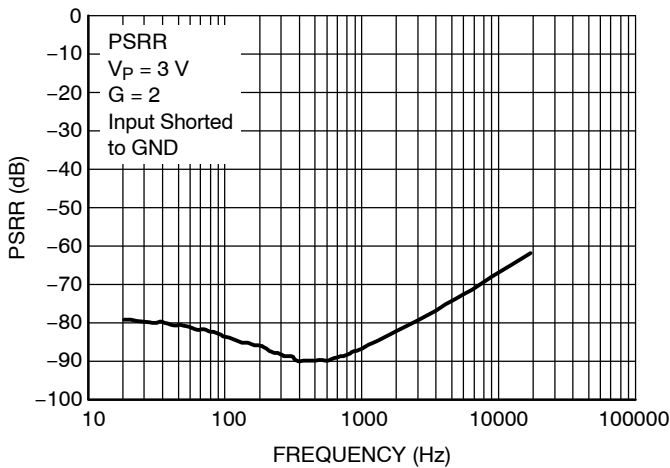

Figure 17. PSRR vs. Frequency

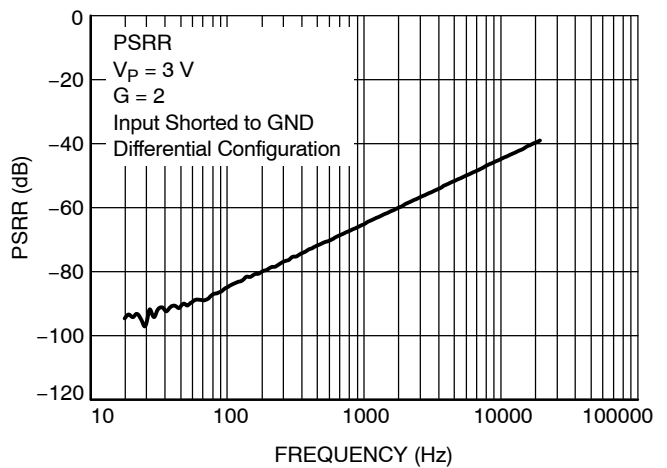

Figure 18. PSRR vs. Frequency

NCP2993

TYPICAL CHARACTERISTICS

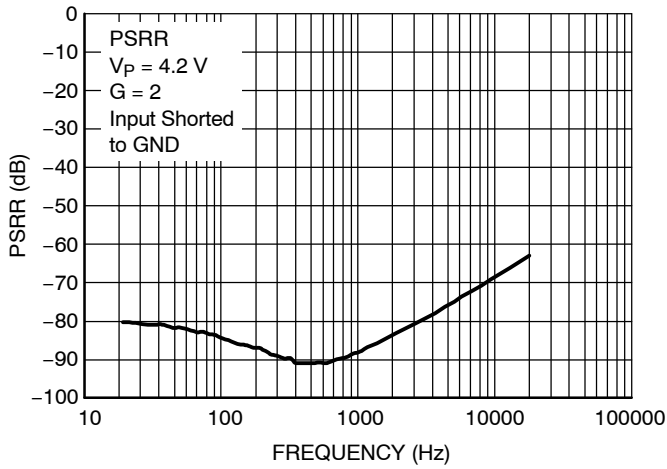

Figure 19. PSRR vs. Frequency

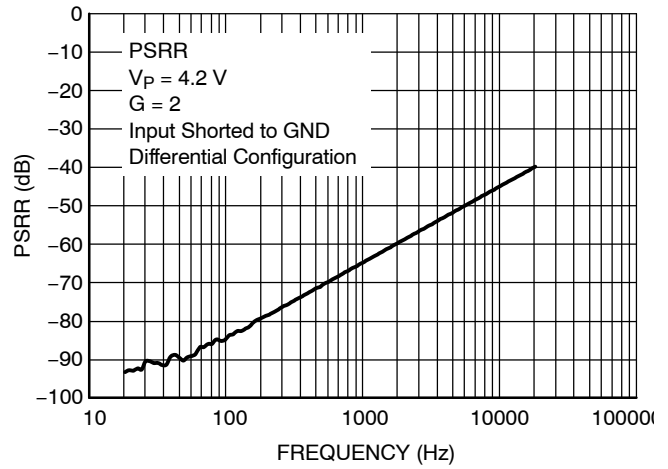

Figure 20. PSRR vs. Frequency

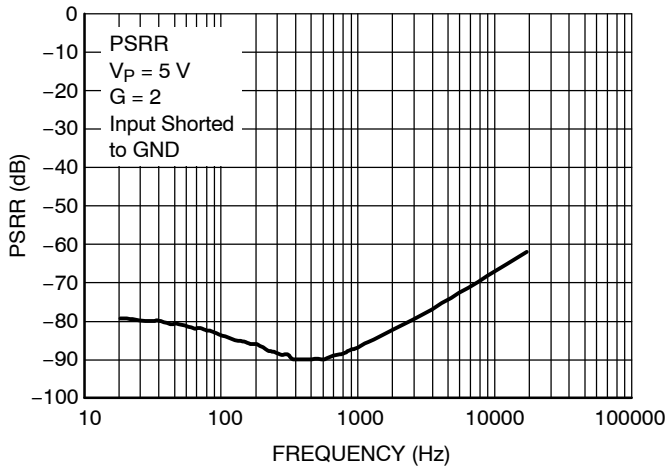

Figure 21. PSRR vs. Frequency

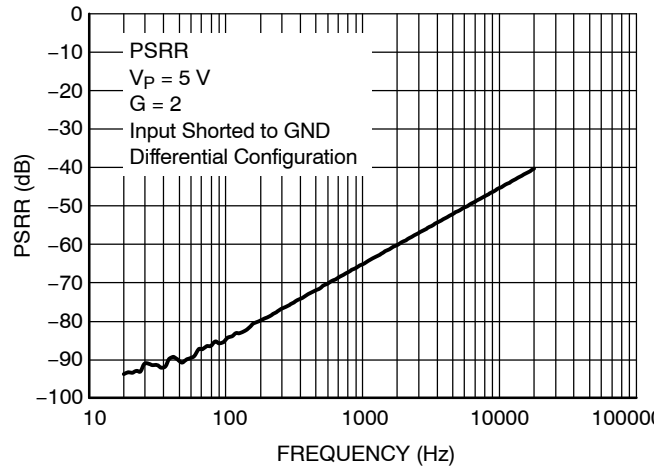

Figure 22. PSRR vs. Frequency

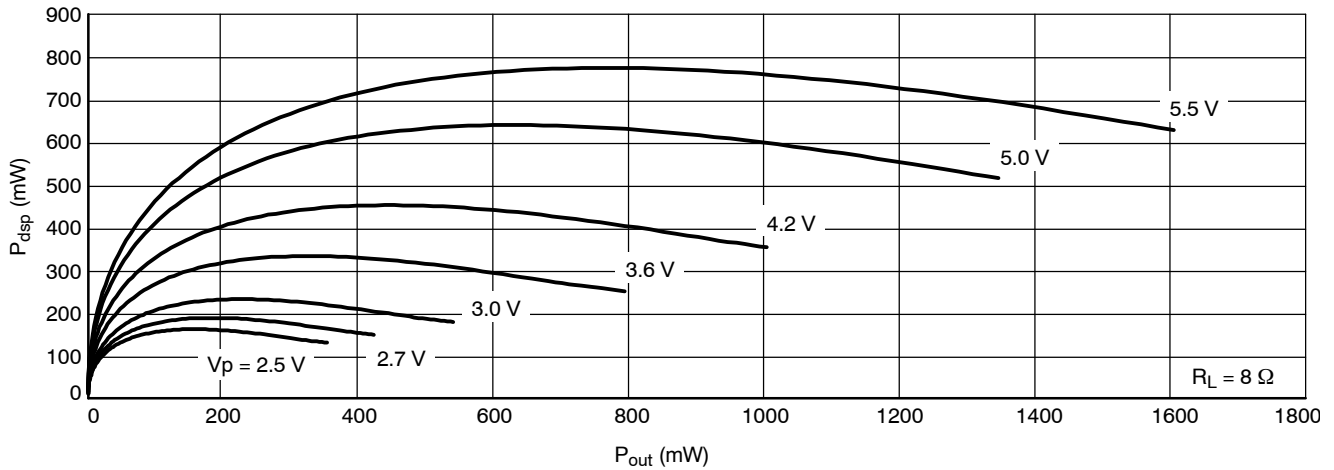

Figure 23. Power Dissipation vs. P_{out}

NCP2993

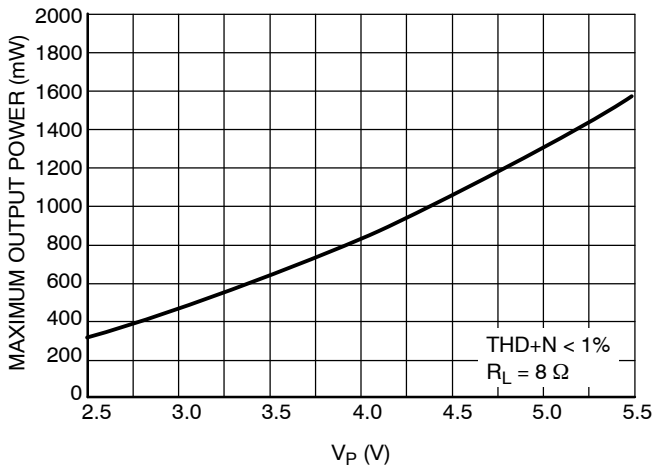

Figure 24. Maximum Output Power vs. V_P

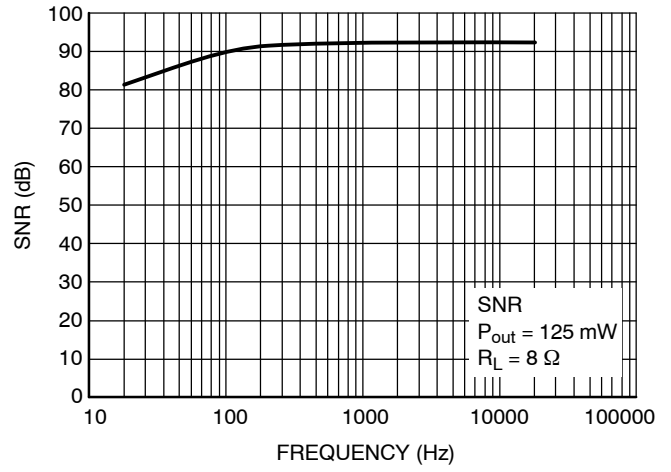

Figure 25. SNR vs. Frequency

APPLICATION INFORMATION

Detailed Description

The NCP2993 audio amplifier can operate under 2.5 V until 5.5 V power supply. With less than 1% THD + N, it can deliver up to 1.35 W RMS output power to an 8.0 Ω load ($V_P = 5.0$ V). If application allows to reach 10% THD + N, then 1.65 W can be provided using a 5.0 V power supply.

The structure of the NCP2993 is basically composed of two identical internal power amplifiers; the first one is externally configurable with gain-setting resistors R_{in} and R_f (the closed-loop gain is fixed by the ratios of these resistors) and the second is internally fixed in an inverting unity-gain configuration by two resistors of 20 k Ω . So the load is driven differentially through OUTA and OUTB outputs. This configuration eliminates the need for an output coupling capacitor.

Internal Power Amplifier

The output PMOS and NMOS transistors of the amplifier were designed to deliver the output power of the specifications without clipping. The channel resistance (R_{on}) of the NMOS and PMOS transistors does not exceed 0.6 Ω when they drive current.

The structure of the internal power amplifier is composed of three symmetrical gain stages, first and medium gain stages are transconductance gain stages to obtain maximum bandwidth and DC gain.

Turn-On and Turn-Off Transitions

When a shutdown low level is applied, the output level is tied to Ground on each output after 10 μ s.

With $T_{ON} = GND$, turn on time is set to 30 ms. With $T_{ON} = V_P$, turn on time is set to 15 ms. To avoid any pop and click noises, $R_{in} * C_{in} < 2.4$ ms with $T_{ON} = GND$ and $R_{in} * C_{in} < 1.2$ ms with $T_{ON} = V_P$. The electrical characteristics are identical with the 2 configurations. This fast turn on time added to a very low shutdown current saves battery life and brings flexibility when designing the audio section of the final application.

NCP2993 is a zero pop noise device when using a single-ended or differential audio input configuration.

Shutdown Function

The device enters shutdown mode when shutdown signal is low. During the shutdown mode, the DC quiescent current of the circuit does not exceed 100 nA. In this configuration, the output impedance is 8.5 k Ω on each output.

Current Limit Circuit

The maximum output power of the circuit ($P_{orms} = 1.0$ W, $V_P = 5.0$ V, $R_L = 8.0$ Ω) requires a peak current in the load of 500 mA.

In order to limit the excessive power dissipation in the load when a short-circuit occurs, the current limit in the load is fixed to 1.1 A. The current in the four output MOS

transistors are real-time controlled, and when one current exceeds 1.1 A, the gate voltage of the MOS transistor is clipped and no more current can be delivered.

Thermal Overload Protection

Internal amplifiers are switched off when the temperature exceeds 160°C, and will be switched on again only when the temperature decreases fewer than 140°C.

The NCP2993 is unity-gain stable and requires no external components besides gain-setting resistors, an input coupling capacitor and a proper bypassing capacitor in the typical application.

The first amplifier is externally configurable (R_f and R_{in}), while the second is fixed in an inverting unity gain configuration.

The differential-ended amplifier presents two major advantages:

- The possible output power is four times larger (the output swing is doubled) as compared to a single-ended amplifier under the same conditions.
- Output pins (OUTA and OUTB) are biased at the same potential $V_P/2$, this eliminates the need for an output coupling capacitor required with a single-ended amplifier configuration.

The differential closed loop-gain of the amplifier is given by $A_{vd} = 2 * \frac{R_f}{R_{in}} = \frac{V_{orms}}{V_{inrms}}$.

Output power delivered to the load is given by $P_{orms} = \frac{(V_{opeak})^2}{2 * R_L}$ (V_{opeak} is the peak differential output voltage).

When choosing gain configuration to obtain the desired output power, check that the amplifier is not current limited or clipped.

The maximum current which can be delivered to the load is 500 mA $I_{opeak} = \frac{V_{opeak}}{R_L}$.

Gain-Setting Resistor Selection (R_{in} and R_f)

R_{in} and R_f set the closed-loop gain of the amplifier.

In order to optimize device and system performance, the NCP2993 should be used in low gain configurations.

The low gain configuration minimizes THD + noise values and maximizes the signal to noise ratio, and the amplifier can still be used without running into the bandwidth limitations.

A closed loop gain in the range from 2 to 5 is recommended to optimize overall system performance.

An input resistor (R_{in}) value of 24 k Ω is realistic in most of applications, and doesn't require the use of a too large capacitor C_{in} .

Input Capacitor Selection (C_{in})

The input coupling capacitor blocks the DC voltage at the amplifier input terminal. This capacitor creates a

NCP2993

high-pass filter with R_{in} , the cut-off frequency is given by

$$f_c = \frac{1}{2 * \pi * R_{in} * C_{in}}$$

The size of the capacitor must be large enough to couple in low frequencies without severe attenuation.

IEC 61000-4-2 Level 4

In some particular applications, NCP2993 may need extra ESD protection to pass IEC 61000-4-2 Level 4 qualification.

Depending on the test, user can consider different level of protection:

- up to 22 pF capacitor connected between each amplifier output terminals and ground.
- Dedicated IEC filters such as ESD7.0 series from ON Semiconductor.

In any case, the protection should be placed as close as possible to the ESD stress entry point. Proper and carefull layout is a key factor to ensure optimum protection level is achieved. Designer should make sure the connection impedance between protection and ground / protection and NCP2993 is as low as possible.

ORDERING INFORMATION

Device	Package	Shipping†
NCP2993FCT2G	9-Pin Flip-Chip (Pb-Free)	3000 / Tape & Reel

†For information on tape and reel specifications, including part orientation and tape sizes, please refer to our Tape and Reel Packaging Specifications Brochure, BRD8011/D.

MECHANICAL CASE OUTLINE

PACKAGE DIMENSIONS

ON Semiconductor®



SCALE 4:1

WLCSP9, 1.22x1.22
CASE 499BM-01
ISSUE O

DATE 27 SEP 2010

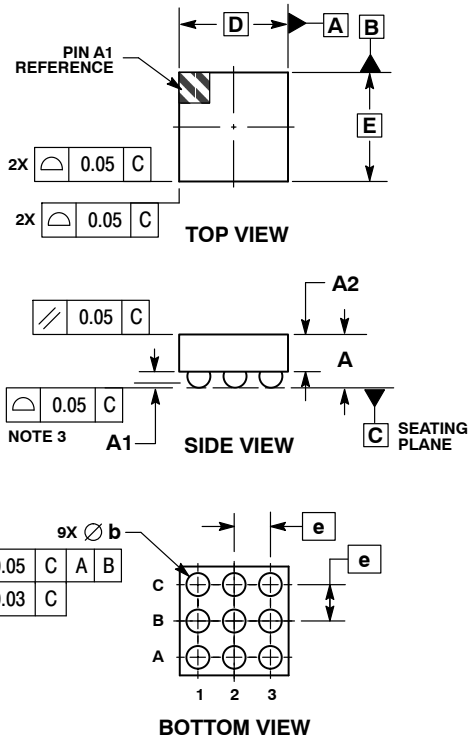

NOTES:

1. DIMENSIONING AND TOLERANCING PER ASME Y14.5M, 1994.
2. CONTROLLING DIMENSION: MILLIMETERS.
3. COPLANARITY APPLIES TO SPHERICAL CROWNS OF SOLDER BALLS.

DIM	MILLIMETERS	
	MIN	MAX
A	---	0.66
A1	0.17	0.24
A2	0.40 REF	
b	0.24	0.29
D	1.22 BSC	
E	1.22 BSC	
e	0.40 BSC	

GENERIC MARKING DIAGRAM*

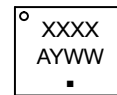

- XXXX = Specific Device Code
- A = Assembly Location
- Y = Year
- WW = Work Week
- = Pb-Free Package

*This information is generic. Please refer to device data sheet for actual part marking.
Pb-Free indicator, "G" or microdot "▪", may or may not be present.

RECOMMENDED SOLDERING FOOTPRINT*

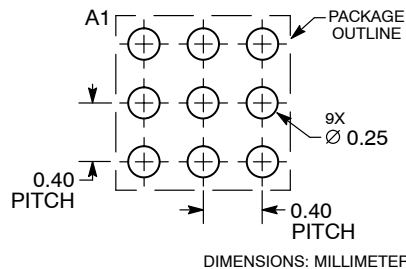

*For additional information on our Pb-Free strategy and soldering details, please download the ON Semiconductor Soldering and Mounting Techniques Reference Manual, SOLDERRM/D.

DOCUMENT NUMBER:	98AON53177E	Electronic versions are uncontrolled except when accessed directly from the Document Repository. Printed versions are uncontrolled except when stamped "CONTROLLED COPY" in red.
DESCRIPTION:	WLCSP9, 1.22X1.22	PAGE 1 OF 1

ON Semiconductor and are trademarks of Semiconductor Components Industries, LLC dba ON Semiconductor or its subsidiaries in the United States and/or other countries. ON Semiconductor reserves the right to make changes without further notice to any products herein. ON Semiconductor makes no warranty, representation or guarantee regarding the suitability of its products for any particular purpose, nor does ON Semiconductor assume any liability arising out of the application or use of any product or circuit, and specifically disclaims any and all liability, including without limitation special, consequential or incidental damages. ON Semiconductor does not convey any license under its patent rights nor the rights of others.

onsemi, **Onsemi**, and other names, marks, and brands are registered and/or common law trademarks of Semiconductor Components Industries, LLC dba "**onsemi**" or its affiliates and/or subsidiaries in the United States and/or other countries. **onsemi** owns the rights to a number of patents, trademarks, copyrights, trade secrets, and other intellectual property. A listing of **onsemi**'s product/patent coverage may be accessed at www.onsemi.com/site/pdf/Patent-Marking.pdf. **onsemi** reserves the right to make changes at any time to any products or information herein, without notice. The information herein is provided "as-is" and **onsemi** makes no warranty, representation or guarantee regarding the accuracy of the information, product features, availability, functionality, or suitability of its products for any particular purpose, nor does **onsemi** assume any liability arising out of the application or use of any product or circuit, and specifically disclaims any and all liability, including without limitation special, consequential or incidental damages. Buyer is responsible for its products and applications using **onsemi** products, including compliance with all laws, regulations and safety requirements or standards, regardless of any support or applications information provided by **onsemi**. "Typical" parameters which may be provided in **onsemi** data sheets and/or specifications can and do vary in different applications and actual performance may vary over time. All operating parameters, including "Typicals" must be validated for each customer application by customer's technical experts. **onsemi** does not convey any license under any of its intellectual property rights nor the rights of others. **onsemi** products are not designed, intended, or authorized for use as a critical component in life support systems or any FDA Class 3 medical devices or medical devices with a same or similar classification in a foreign jurisdiction or any devices intended for implantation in the human body. Should Buyer purchase or use **onsemi** products for any such unintended or unauthorized application, Buyer shall indemnify and hold **onsemi** and its officers, employees, subsidiaries, affiliates, and distributors harmless against all claims, costs, damages, and expenses, and reasonable attorney fees arising out of, directly or indirectly, any claim of personal injury or death associated with such unintended or unauthorized use, even if such claim alleges that **onsemi** was negligent regarding the design or manufacture of the part. **onsemi** is an Equal Opportunity/Affirmative Action Employer. This literature is subject to all applicable copyright laws and is not for resale in any manner.

ADDITIONAL INFORMATION

TECHNICAL PUBLICATIONS:

Technical Library: www.onsemi.com/design/resources/technical-documentation
onsemi Website: www.onsemi.com

ONLINE SUPPORT: www.onsemi.com/support

For additional information, please contact your local Sales Representative at www.onsemi.com/support/sales