

# NTGD3147F

## Power MOSFET and Schottky Diode

-20 V, -2.5 A, P-Channel with Schottky Barrier Diode, TSOP-6

### Features

- Fast Switching
- Low Gate Change
- Low  $R_{DS(on)}$
- Low  $V_F$  Schottky Diode
- Independently Connected Devices to Provide Design Flexibility
- This is a Pb-Free Device

### Applications

- DC-DC Converters
- Portable Devices like PDA's, Cellular Phones, and Hard Drives

### MAXIMUM RATINGS ( $T_J = 25^\circ\text{C}$ unless otherwise noted)

Parameter		Symbol	Value	Unit	
Drain-to-Source Voltage		$V_{DSS}$	-20	V	
Gate-to-Source Voltage		$V_{GS}$	$\pm 12$	V	
Continuous Drain Current (Note 1)	Steady State	$I_D$	$T_A = 25^\circ\text{C}$ $T_A = 85^\circ\text{C}$	-2.2 -1.6	A
	$t \leq 5$ s		$T_A = 25^\circ\text{C}$	-2.5	
Power Dissipation (Note 1)	Steady State	$P_D$	$T_A = 25^\circ\text{C}$	1.0	W
	$t \leq 5$ s			1.3	
Pulsed Drain Current		$I_{DM}$	-7.5	A	
Operating Junction and Storage Temperature		$T_J, T_{STG}$	-25 to 150	$^\circ\text{C}$	
Source Current (Body Diode)		$I_S$	-0.8	A	
Lead Temperature for Soldering Purposes (1/8" from case for 10 s)		$T_L$	260	$^\circ\text{C}$	

### SCHOTTKY MAXIMUM RATINGS ( $T_J = 25^\circ\text{C}$ unless otherwise stated)

Parameter	Symbol	Value	Unit
Peak Repetitive Reverse Voltage	$V_{RRM}$	20	V
DC Blocking Voltage	$V_R$	20	V
Average Rectified Forward Current	$I_F$	1	A

### THERMAL RESISTANCE RATINGS

Parameter	Symbol	Value	Unit
Junction-to-Ambient - Steady-State (Note 1)	$R_{\theta JA}$	125	$^\circ\text{C}/\text{W}$
Junction-to-Ambient - $t \leq 5$ s (Note 1)	$R_{\theta JA}$	100	$^\circ\text{C}/\text{W}$
Junction-to-Ambient Steady-State (Note 2)	$R_{\theta JA}$	235	$^\circ\text{C}/\text{W}$

Stresses exceeding Maximum Ratings may damage the device. Maximum Ratings are stress ratings only. Functional operation above the Recommended Operating Conditions is not implied. Extended exposure to stresses above the Recommended Operating Conditions may affect device reliability.

1. Surface Mounted on FR4 Board using 1 in sq pad size (Cu area = 1.127 in sq [2 oz] including traces).
2. Surface Mounted on FR4 Board using the minimum recommended pad size (Cu area = 30 mm<sup>2</sup> [2 oz] including traces).



ON Semiconductor®

<http://onsemi.com>

### P-CHANNEL MOSFET

$V_{(BR)DSS}$	$R_{DS(on)}$ Max	$I_D$ Max
-20 V	145 m $\Omega$ @ -4.5 V	-2.2 A
	200 m $\Omega$ @ -2.5 V	-1.6 A

### SCHOTTKY DIODE

$V_R$ Max	$V_F$ Max	$I_F$ Max
20 V	0.45 V	1.0 A

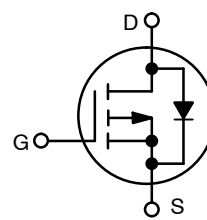

P-Channel MOSFET



Schottky Diode



TSOP-6  
CASE 318G  
STYLE 15

### MARKING DIAGRAM

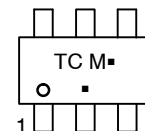

TC = Specific Device Code

M = Date Code

■ = Pb-Free Package

(Note: Microdot may be in either location)

### PIN CONNECTION

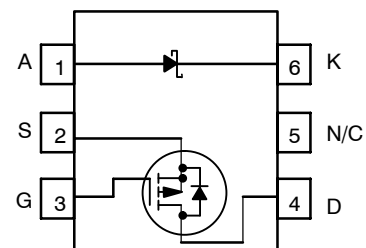

(Top View)

### ORDERING INFORMATION

See detailed ordering and shipping information in the package dimensions section on page 6 of this data sheet.

# NTGD3147F

## MOSFET ELECTRICAL CHARACTERISTICS ( $T_J = 25^\circ\text{C}$ unless otherwise noted)

Characteristic	Symbol	Test Condition	Min	Typ	Max	Unit
----------------	--------	----------------	-----	-----	-----	------

### OFF CHARACTERISTICS

Drain-to-Source Breakdown Voltage	$V_{(BR)DSS}$	$V_{GS} = 0\text{ V}, I_D = 250\ \mu\text{A}$	-20			V	
Drain-to-Source Breakdown Voltage Temperature Coefficient	$V_{(BR)DSS}/T_J$			14.2		mV/ $^\circ\text{C}$	
Zero Gate Voltage Drain Current	$I_{DSS}$	$V_{GS} = 0\text{ V}, V_{DS} = -16\text{ V}$	$T_J = 25^\circ\text{C}$			-1.0	$\mu\text{A}$
			$T_J = 85^\circ\text{C}$			-10	
Gate-to-Source Leakage Current	$I_{GSS}$	$V_{DS} = 0\text{ V}, V_{GS} = \pm 12\text{ V}$			$\pm 100$	nA	

### ON CHARACTERISTICS (Note 3)

Gate Threshold Voltage	$V_{GS(TH)}$	$V_{GS} = V_{DS}, I_D = -250\ \mu\text{A}$	-0.5	-0.95	-1.5	V
Gate Threshold Temperature Coefficient	$V_{GS(TH)}/T_J$			3.0		mV/ $^\circ\text{C}$
Drain-to-Source On Resistance	$R_{DS(on)}$	$V_{GS} = -4.5\text{ V}, I_D = -2.2\text{ A}$		90	145	m $\Omega$
		$V_{GS} = -2.5\text{ V}, I_D = -1.6\text{ A}$		140	200	
Forward Transconductance	$g_{FS}$	$V_{DS} = -5.0\text{ V}, I_D = -2.2\text{ A}$		4.5		S

### CHARGES, CAPACITANCES AND GATE RESISTANCE

Input Capacitance	$C_{ISS}$	$V_{GS} = 0\text{ V}, f = 1.0\text{ MHz}, V_{DS} = -10\text{ V}$		400		pF
Output Capacitance	$C_{OSS}$			75		
Reverse Transfer Capacitance	$C_{RSS}$			40		
Total Gate Charge	$Q_{G(TOT)}$	$V_{GS} = -4.5\text{ V}, V_{DS} = -10\text{ V}, I_D = -2.2\text{ A}$		3.8	5.5	nC
Threshold Gate Charge	$Q_{G(TH)}$			0.5		
Gate-to-Source Charge	$Q_{GS}$			0.9		
Gate-to-Drain Charge	$Q_{GD}$			1.0		

### SWITCHING CHARACTERISTICS (Note 4)

Turn-On Delay Time	$t_{d(ON)}$	$V_{GS} = -4.5\text{ V}, V_{DS} = -10\text{ V}, I_D = -1.0\text{ A}, R_G = 6.0\ \Omega$		7.5		ns
Rise Time	$t_r$			6.2		
Turn-Off Delay Time	$t_{d(OFF)}$			14.5		
Fall Time	$t_f$			18.4		

### DRAIN-TO-SOURCE CHARACTERISTICS

Forward Diode Voltage	$V_{SD}$	$V_{GS} = 0\text{ V}, I_D = -0.8\text{ A}$	$T_J = 25^\circ\text{C}$		-0.8	1.2	V
Reverse Recovery Time	$t_{RR}$	$V_{GS} = 0\text{ V}, dI_S/dt = 100\text{ A}/\mu\text{s}, I_S = -0.8\text{ A}$			12		ns
Charge Time	$T_a$				8.0		
Discharge Time	$T_b$				4.0		
Reverse Recovery Time	$Q_{RR}$				4.0		nC

3. Pulse Test: pulse width  $\leq 300\ \mu\text{s}$ , duty cycle  $\leq 2\%$ .

4. Switching characteristics are independent of operating junction temperatures.

# NTGD3147F

## SCHOTTKY DIODE ELECTRICAL CHARACTERISTICS ( $T_J = 25^\circ\text{C}$ unless otherwise noted)

Parameter	Symbol	Test Conditions	Min	Typ	Max	Unit
Maximum Instantaneous Forward Voltage	$V_F$	$I_F = 0.5 \text{ A}$		0.32	0.4	V
		$I_F = 1.0 \text{ A}$		0.36	0.45	
Maximum Instantaneous Reverse Current	$I_R$	$V_R = 10 \text{ V}$		0.04	1.0	mA
		$V_R = 20 \text{ V}$		0.21	5.0	

## SCHOTTKY DIODE ELECTRICAL CHARACTERISTICS ( $T_J = 75^\circ\text{C}$ unless otherwise noted)

Parameter	Symbol	Test Conditions	Min	Typ	Max	Unit
Maximum Instantaneous Forward Voltage	$V_F$	$I_F = 0.5 \text{ A}$		0.27		V
		$I_F = 1.0 \text{ A}$		0.31		
Maximum Instantaneous Reverse Current	$I_R$	$V_R = 10 \text{ V}$		0.77		mA
		$V_R = 20 \text{ V}$		2.65		

## SCHOTTKY DIODE ELECTRICAL CHARACTERISTICS ( $T_J = 125^\circ\text{C}$ unless otherwise noted)

Parameter	Symbol	Test Conditions	Min	Typ	Max	Unit
Maximum Instantaneous Forward Voltage	$V_F$	$I_F = 0.5 \text{ A}$		0.22		V
		$I_F = 1.0 \text{ A}$		0.27		
Maximum Instantaneous Reverse Current	$I_R$	$V_R = 10 \text{ V}$		8.75		mA
		$V_R = 20 \text{ V}$		37.37		

TYPICAL PERFORMANCE CHARACTERISTICS

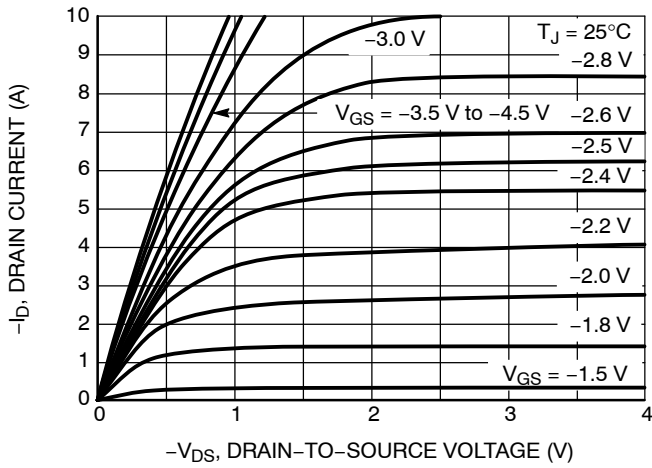

Figure 1. On-Region Characteristics

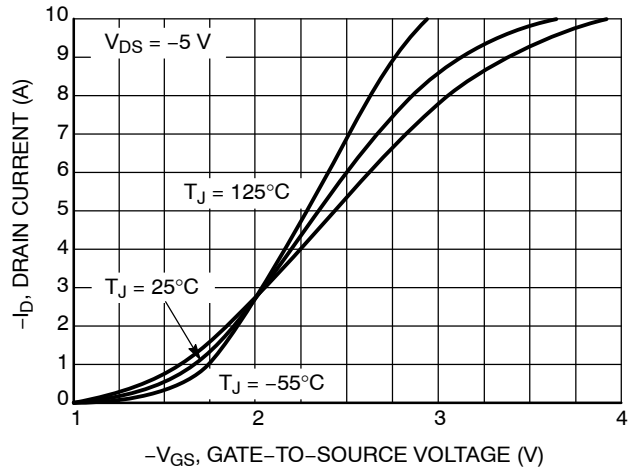

Figure 2. Transfer Characteristics

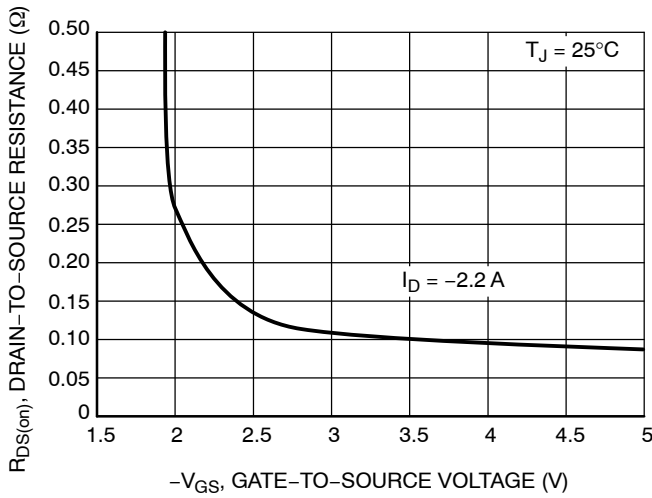

Figure 3. On-Resistance versus Gate-to-Source Voltage

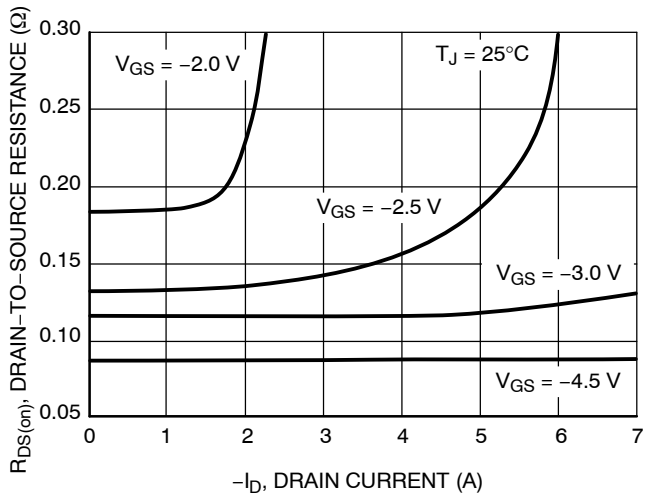

Figure 4. On-Resistance versus Drain Current and Gate Voltage

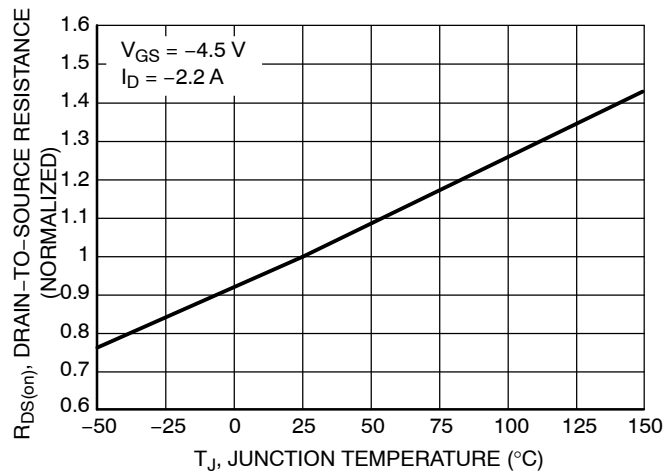

Figure 5. On-Resistance Variation with Temperature

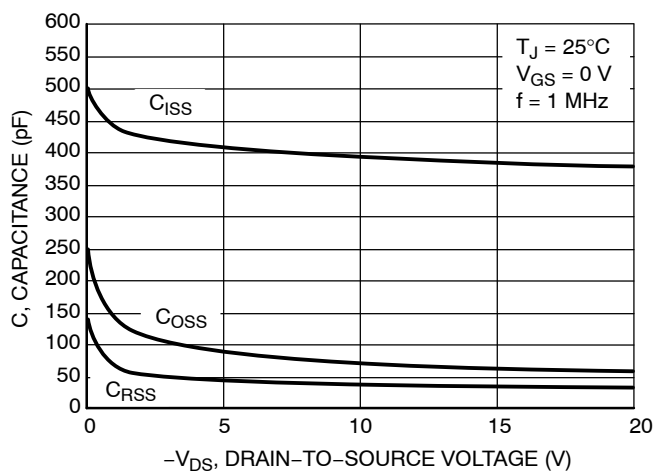

Figure 6. Capacitance Variation

TYPICAL PERFORMANCE CHARACTERISTICS

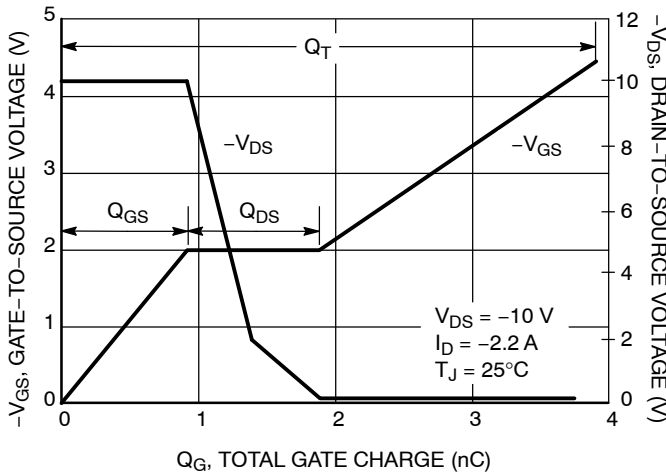

Figure 7. Gate-to-Source and Drain-to-Source Voltage versus Total Charge

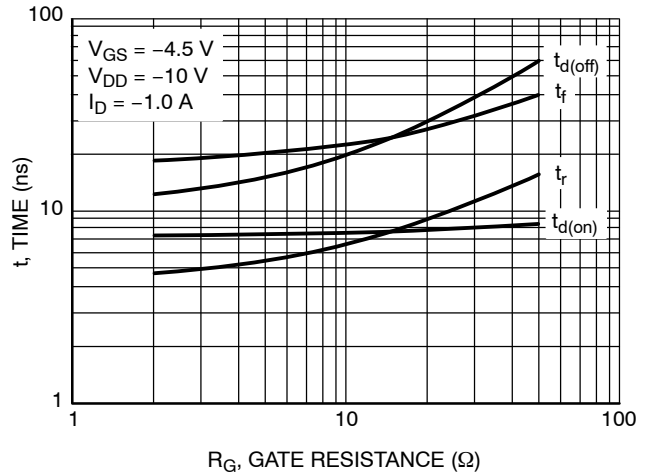

Figure 8. Resistive Switching Time Variation versus Gate Resistance

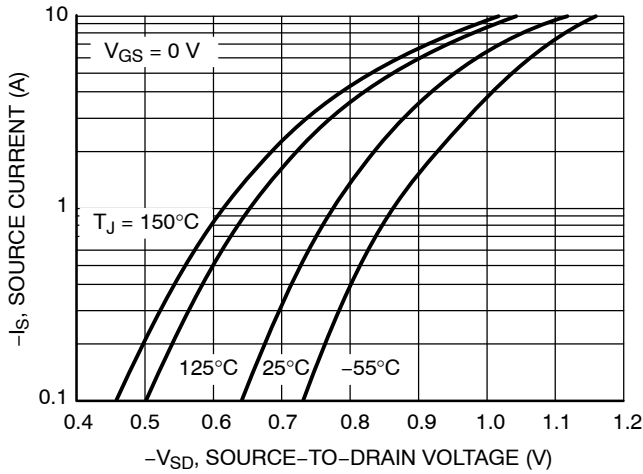

Figure 9. Diode Forward Voltage versus Current

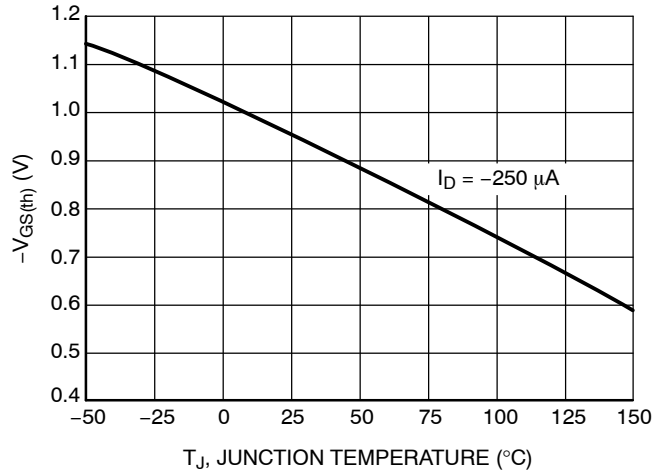

Figure 10. Threshold Voltage

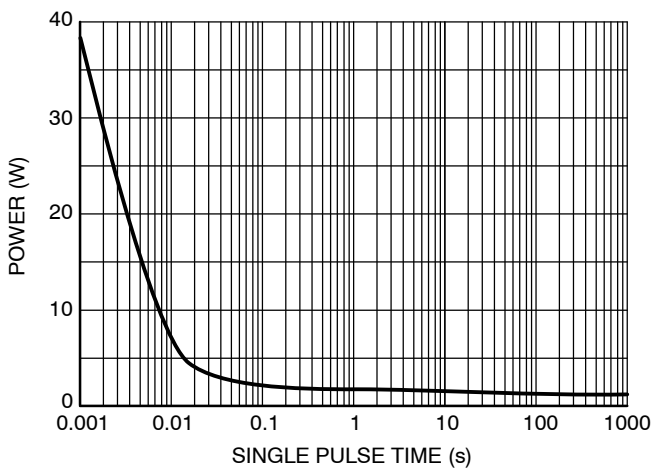

Figure 11. Single Pulse Maximum Power Dissipation

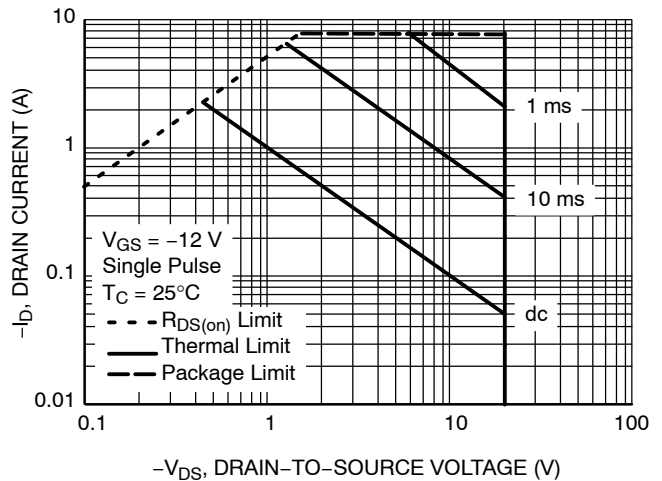

Figure 12. Maximum Rated Forward Biased Safe Operating Area

# NTGD3147F

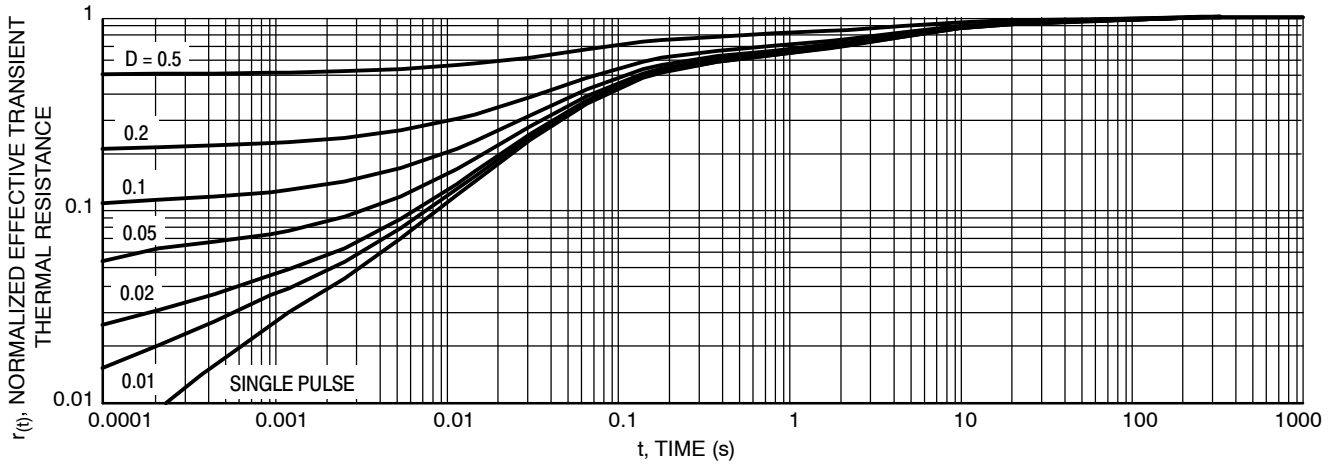

Figure 13. Thermal Response

## TYPICAL SCHOTTKY CHARACTERISTICS

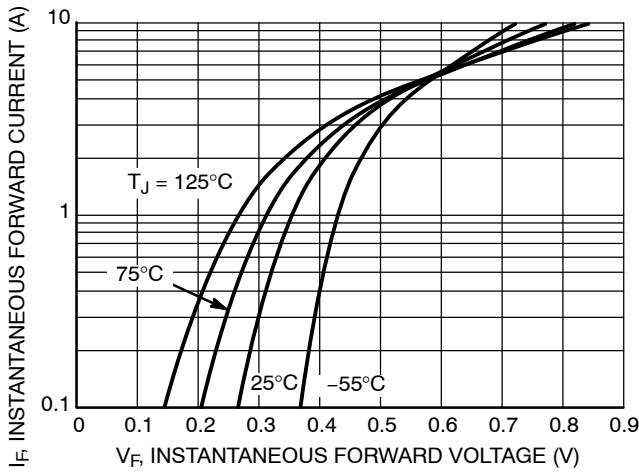

Figure 14. Typical Forward Voltage

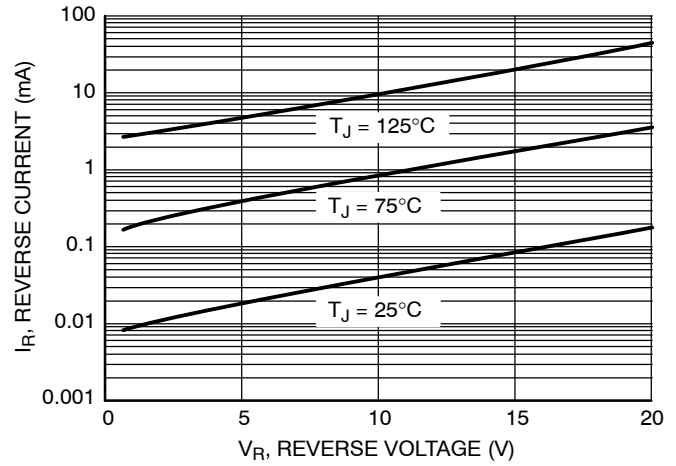
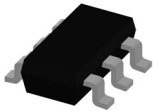

Figure 15. Typical Reverse Current

### ORDERING INFORMATION

Device	Package	Shipping <sup>†</sup>
NTGD3147FT1G	TSOP-6 (Pb-Free)	3000 / Tape & Reel

<sup>†</sup>For information on tape and reel specifications, including part orientation and tape sizes, please refer to our Tape and Reel Packaging Specifications Brochure, BRD8011/D.



**TSOP-6 3.00x1.50x0.90, 0.95P**  
**CASE 318G**  
**ISSUE W**

DATE 26 FEB 2024

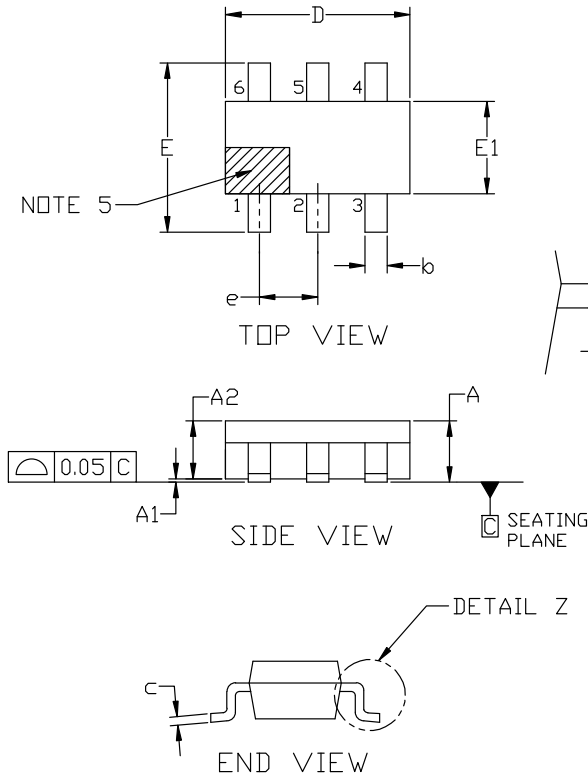

NOTES:

1. DIMENSIONING AND TOLERANCING PER ASME Y14.5M, 2018.
2. CONTROLLING DIMENSION: MILLIMETERS.
3. MAXIMUM LEAD THICKNESS INCLUDES LEAD FINISH. MINIMUM LEAD THICKNESS IS THE MINIMUM THICKNESS OF BASE MATERIAL.
4. DIMENSIONS D AND E1 DO NOT INCLUDE MOLD FLASH, PROTRUSIONS, OR GATE BURRS. MOLD FLASH, PROTRUSIONS, OR GATE BURRS SHALL NOT EXCEED 0.15 PER SIDE. DIMENSIONS D AND E1 ARE DETERMINED AT DATUM H.
5. PIN 1 INDICATOR MUST BE LOCATED IN THE INDICATED ZONE

MILLIMETERS			
DIM	MIN	NOM	MAX
A	0.90	1.00	1.10
A1	0.01	0.06	0.10
A2	0.80	0.90	1.00
b	0.25	0.38	0.50
c	0.10	0.18	0.26
D	2.90	3.00	3.10
E	2.50	2.75	3.00
E1	1.30	1.50	1.70
e	0.85	0.95	1.05
L	0.20	0.40	0.60
L2	0.25 BSC		
M	0°	---	10°

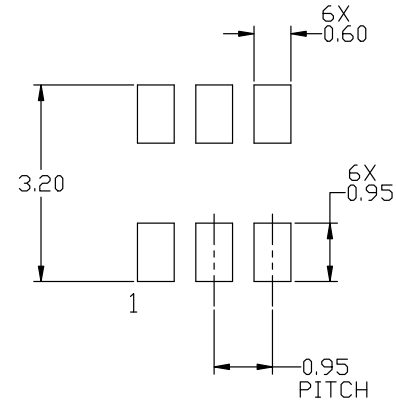
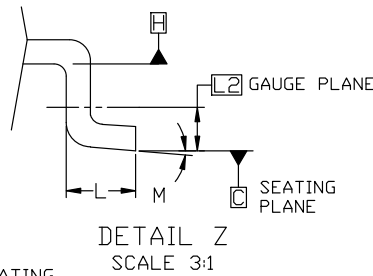

RECOMMENDED MOUNTING FOOTPRINT

\*For additional information on our Pb-Free strategy and soldering details, please download the ON Semiconductor Soldering and Mounting Techniques Reference manual, SOLDERRM/D.

<b>DOCUMENT NUMBER:</b>	<b>98ASB14888C</b>	Electronic versions are uncontrolled except when accessed directly from the Document Repository. Printed versions are uncontrolled except when stamped "CONTROLLED COPY" in red.
<b>DESCRIPTION:</b>	<b>TSOP-6 3.00x1.50x0.90, 0.95P</b>	<b>PAGE 1 OF 2</b>

onsemi and ONSEMI are trademarks of Semiconductor Components Industries, LLC dba onsemi or its subsidiaries in the United States and/or other countries. onsemi reserves the right to make changes without further notice to any products herein. onsemi makes no warranty, representation or guarantee regarding the suitability of its products for any particular purpose, nor does onsemi assume any liability arising out of the application or use of any product or circuit, and specifically disclaims any and all liability, including without limitation special, consequential or incidental damages. onsemi does not convey any license under its patent rights nor the rights of others.

**TSOP-6 3.00x1.50x0.90, 0.95P**  
**CASE 318G**  
**ISSUE W**

DATE 26 FEB 2024

**GENERIC  
MARKING DIAGRAM\***

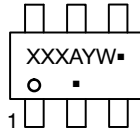

**IC**

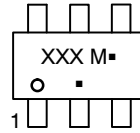

**STANDARD**

XXX = Specific Device Code	XXX = Specific Device Code
A = Assembly Location	M = Date Code
Y = Year	▪ = Pb-Free Package
W = Work Week	
▪ = Pb-Free Package	

\*This information is generic. Please refer to device data sheet for actual part marking. Pb-Free indicator, "G" or microdot "▪", may or may not be present. Some products may not follow the Generic Marking.

- |  |  |   |   |   |  |
|--|--|---|---|---|--|
| <p>STYLE 1:<br/> PIN 1. DRAIN<br/> 2. DRAIN<br/> 3. GATE<br/> 4. SOURCE<br/> 5. DRAIN<br/> 6. DRAIN</p>              | <p>STYLE 2:<br/> PIN 1. EMITTER 2<br/> 2. BASE 1<br/> 3. COLLECTOR 1<br/> 4. EMITTER 1<br/> 5. BASE 2<br/> 6. COLLECTOR 2</p>    | <p>STYLE 3:<br/> PIN 1. ENABLE<br/> 2. N/C<br/> 3. R BOOST<br/> 4. Vz<br/> 5. V in<br/> 6. V out</p>                            | <p>STYLE 4:<br/> PIN 1. N/C<br/> 2. V in<br/> 3. NOT USED<br/> 4. GROUND<br/> 5. ENABLE<br/> 6. LOAD</p>                | <p>STYLE 5:<br/> PIN 1. EMITTER 2<br/> 2. BASE 2<br/> 3. COLLECTOR 1<br/> 4. EMITTER 1<br/> 5. BASE 1<br/> 6. COLLECTOR 2</p> | <p>STYLE 6:<br/> PIN 1. COLLECTOR<br/> 2. COLLECTOR<br/> 3. BASE<br/> 4. EMITTER<br/> 5. COLLECTOR<br/> 6. COLLECTOR</p> |
| <p>STYLE 7:<br/> PIN 1. COLLECTOR<br/> 2. COLLECTOR<br/> 3. BASE<br/> 4. N/C<br/> 5. COLLECTOR<br/> 6. EMITTER</p>   | <p>STYLE 8:<br/> PIN 1. Vbus<br/> 2. D(in)<br/> 3. D(in)+<br/> 4. D(out)+<br/> 5. D(out)<br/> 6. GND</p>                         | <p>STYLE 9:<br/> PIN 1. LOW VOLTAGE GATE<br/> 2. DRAIN<br/> 3. SOURCE<br/> 4. DRAIN<br/> 5. DRAIN<br/> 6. HIGH VOLTAGE GATE</p> | <p>STYLE 10:<br/> PIN 1. D(OUT)+<br/> 2. GND<br/> 3. D(OUT)-<br/> 4. D(IN)-<br/> 5. VBUS<br/> 6. D(IN)+</p>             | <p>STYLE 11:<br/> PIN 1. SOURCE 1<br/> 2. DRAIN 2<br/> 3. DRAIN 2<br/> 4. SOURCE 2<br/> 5. GATE 1<br/> 6. DRAIN 1/GATE 2</p>  | <p>STYLE 12:<br/> PIN 1. I/O<br/> 2. GROUND<br/> 3. I/O<br/> 4. I/O<br/> 5. VCC<br/> 6. I/O</p>                          |
| <p>STYLE 13:<br/> PIN 1. GATE 1<br/> 2. SOURCE 2<br/> 3. GATE 2<br/> 4. DRAIN 2<br/> 5. SOURCE 1<br/> 6. DRAIN 1</p> | <p>STYLE 14:<br/> PIN 1. ANODE<br/> 2. SOURCE<br/> 3. GATE<br/> 4. CATHODE/DRAIN<br/> 5. CATHODE/DRAIN<br/> 6. CATHODE/DRAIN</p> | <p>STYLE 15:<br/> PIN 1. ANODE<br/> 2. SOURCE<br/> 3. GATE<br/> 4. DRAIN<br/> 5. N/C<br/> 6. CATHODE</p>                        | <p>STYLE 16:<br/> PIN 1. ANODE/CATHODE<br/> 2. BASE<br/> 3. EMITTER<br/> 4. COLLECTOR<br/> 5. ANODE<br/> 6. CATHODE</p> | <p>STYLE 17:<br/> PIN 1. EMITTER<br/> 2. BASE<br/> 3. ANODE/CATHODE<br/> 4. ANODE<br/> 5. CATHODE<br/> 6. COLLECTOR</p>       |  |

<b>DOCUMENT NUMBER:</b>	<b>98ASB14888C</b>	Electronic versions are uncontrolled except when accessed directly from the Document Repository. Printed versions are uncontrolled except when stamped "CONTROLLED COPY" in red.
<b>DESCRIPTION:</b>	<b>TSOP-6 3.00x1.50x0.90, 0.95P</b>	<b>PAGE 2 OF 2</b>

**onsemi** and **ONSEMI** are trademarks of Semiconductor Components Industries, LLC dba **onsemi** or its subsidiaries in the United States and/or other countries. **onsemi** reserves the right to make changes without further notice to any products herein. **onsemi** makes no warranty, representation or guarantee regarding the suitability of its products for any particular purpose, nor does **onsemi** assume any liability arising out of the application or use of any product or circuit, and specifically disclaims any and all liability, including without limitation special, consequential or incidental damages. **onsemi** does not convey any license under its patent rights nor the rights of others.



**onsemi**, **Onsemi**, and other names, marks, and brands are registered and/or common law trademarks of Semiconductor Components Industries, LLC dba "**onsemi**" or its affiliates and/or subsidiaries in the United States and/or other countries. **onsemi** owns the rights to a number of patents, trademarks, copyrights, trade secrets, and other intellectual property. A listing of **onsemi**'s product/patent coverage may be accessed at [www.onsemi.com/site/pdf/Patent-Marking.pdf](http://www.onsemi.com/site/pdf/Patent-Marking.pdf). **onsemi** reserves the right to make changes at any time to any products or information herein, without notice. The information herein is provided "as-is" and **onsemi** makes no warranty, representation or guarantee regarding the accuracy of the information, product features, availability, functionality, or suitability of its products for any particular purpose, nor does **onsemi** assume any liability arising out of the application or use of any product or circuit, and specifically disclaims any and all liability, including without limitation special, consequential or incidental damages. Buyer is responsible for its products and applications using **onsemi** products, including compliance with all laws, regulations and safety requirements or standards, regardless of any support or applications information provided by **onsemi**. "Typical" parameters which may be provided in **onsemi** data sheets and/or specifications can and do vary in different applications and actual performance may vary over time. All operating parameters, including "Typicals" must be validated for each customer application by customer's technical experts. **onsemi** does not convey any license under any of its intellectual property rights nor the rights of others. **onsemi** products are not designed, intended, or authorized for use as a critical component in life support systems or any FDA Class 3 medical devices or medical devices with a same or similar classification in a foreign jurisdiction or any devices intended for implantation in the human body. Should Buyer purchase or use **onsemi** products for any such unintended or unauthorized application, Buyer shall indemnify and hold **onsemi** and its officers, employees, subsidiaries, affiliates, and distributors harmless against all claims, costs, damages, and expenses, and reasonable attorney fees arising out of, directly or indirectly, any claim of personal injury or death associated with such unintended or unauthorized use, even if such claim alleges that **onsemi** was negligent regarding the design or manufacture of the part. **onsemi** is an Equal Opportunity/Affirmative Action Employer. This literature is subject to all applicable copyright laws and is not for resale in any manner.

## ADDITIONAL INFORMATION

### TECHNICAL PUBLICATIONS:

Technical Library: [www.onsemi.com/design/resources/technical-documentation](http://www.onsemi.com/design/resources/technical-documentation)  
onsemi Website: [www.onsemi.com](http://www.onsemi.com)

### ONLINE SUPPORT: [www.onsemi.com/support](http://www.onsemi.com/support)

For additional information, please contact your local Sales Representative at [www.onsemi.com/support/sales](http://www.onsemi.com/support/sales)