

Switch-mode Power Rectifier

DPAK Surface Mount Package

MBRD835L, SBRD8835L

This switch-mode power rectifier which uses the Schottky Barrier principle with a proprietary barrier metal, is designed for use as output rectifiers, free wheeling, protection and steering diodes in switching power supplies, inverters and other inductive switching circuits.

Features

- Low Forward Voltage
- 150°C Operating Junction Temperature
- Epoxy Meets UL 94 V-0 @ 0.125 in
- Compact Size
- Lead Formed for Surface Mount
- SBRD8 Prefix for Automotive and Other Applications Requiring Unique Site and Control Change Requirements; AEC-Q101 Qualified and PPAP Capable
- These Devices are Pb-Free and are RoHS Compliant

Mechanical Characteristics

- Case: Epoxy, Molded
- Weight: 0.4 Gram (Approximately)
- Finish: All External Surfaces Corrosion Resistant and Terminal Leads are Readily Solderable
- Lead and Mounting Surface Temperature for Soldering Purposes: 260°C Max. for 10 Seconds
- Shipped 75 Units Per Plastic Tube
- ESD Rating:
 - ◆ Machine Model = C (> 400 V)
 - ◆ Human Body Model = 3B (> 8000 V)



ON Semiconductor®

www.onsemi.com

SCHOTTKY BARRIER RECTIFIER

8.0 AMPERES, 35 VOLTS

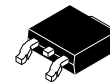

**DPAK
CASE 369C**

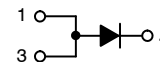

MARKING DIAGRAM

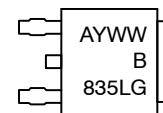

B835LG = Specific Device Number
 A = Assembly Location*
 Y = Year
 WW = Work Week
 G = Pb-Free Device

* The Assembly Location Code (A) is front side optional. In cases where the Assembly Location is stamped in the package bottom (molding ejector pin), the front side assembly code may be blank.

ORDERING INFORMATION

Device	Package	Shipping†
MBRD835LG	DPAK (Pb-Free)	75 Units / Rail
SBRD8835LG	DPAK (Pb-Free)	75 Units / Rail
SBRD8835LG-VF01	DPAK (Pb-Free)	75 Units / Rail
MBRD835LT4G	DPAK (Pb-Free)	2,500 / Tape & Reel
SBRD835LT4G-VF01	DPAK (Pb-Free)	2,500 / Tape & Reel
SBRD8835LT4G	DPAK (Pb-Free)	2,500 / Tape & Reel
SBRD8835LT4G-VF01	DPAK (Pb-Free)	2,500 / Tape & Reel

†For information on tape and reel specifications, including part orientation and tape sizes, please refer to our Tape and Reel Packaging Specifications Brochure BRD8011/D

MBRD835L, SBRD8835L

MAXIMUM RATINGS

Rating	Symbol	Value	Unit
Peak Repetitive Reverse Voltage Working Peak Reverse Voltage DC Blocking Voltage	V_{RRM} V_{RWM} V_R	35	V
Average Rectified Forward Current ($T_C = 88^\circ\text{C}$)	$I_{F(AV)}$	8.0	A
Peak Repetitive Forward Current (Square Wave, Duty = 0.5, $T_C = 80^\circ\text{C}$)	I_{FRM}	16	A
Non-Repetitive Peak Surge Current (Surge applied at rated load conditions, halfwave, single phase, 60 Hz)	I_{FSM}	75	A
Repetitive Avalanche Current (Current Decaying Linearly to Zero in 1 μs , Frequency Limited by T_{Jmax})	I_{AR}	2.0	A
Storage / Operating Case Temperature	T_{stg}	-65 to +150	$^\circ\text{C}$
Operating Junction Temperature (Note 1)	T_J	-65 to +150	$^\circ\text{C}$
Voltage Rate of Change (Rated V_R)	dv/dt	10,000	V/ μs

Stresses exceeding those listed in the Maximum Ratings table may damage the device. If any of these limits are exceeded, device functionality should not be assumed, damage may occur and reliability may be affected.

1. The heat generated must be less than the thermal conductivity from Junction-to-Ambient: $dP_D/dT_J < 1/R_{\theta JA}$.

THERMAL CHARACTERISTICS

Characteristic	Symbol	Value	Unit
Thermal Resistance – Junction-to-Case	$R_{\theta JC}$	2.8	$^\circ\text{C/W}$
Thermal Resistance – Junction-to-Ambient (Note 2)	$R_{\theta JA}$	80	$^\circ\text{C/W}$

2. Rating applies when surface mounted on the minimum pad size recommended.

ELECTRICAL CHARACTERISTICS

Characteristic	Symbol	Value	Unit
Maximum Instantaneous Forward Voltage (Note 3) ($I_F = 8$ Amps, $T_C = +25^\circ\text{C}$) ($I_F = 8$ Amps, $T_C = +125^\circ\text{C}$)	V_F	0.51 0.41	V
Maximum Instantaneous Reverse Current (Note 3) (Rated dc Voltage, $T_C = +25^\circ\text{C}$) (Rated dc Voltage, $T_C = +100^\circ\text{C}$)	I_R	1.4 35	mA

Product parametric performance is indicated in the Electrical Characteristics for the listed test conditions, unless otherwise noted. Product performance may not be indicated by the Electrical Characteristics if operated under different conditions.

3. Pulse Test: Pulse Width = 300 μs , Duty Cycle $\leq 2\%$.

MBRD835L, SBRD8835L

TYPICAL CHARACTERISTICS

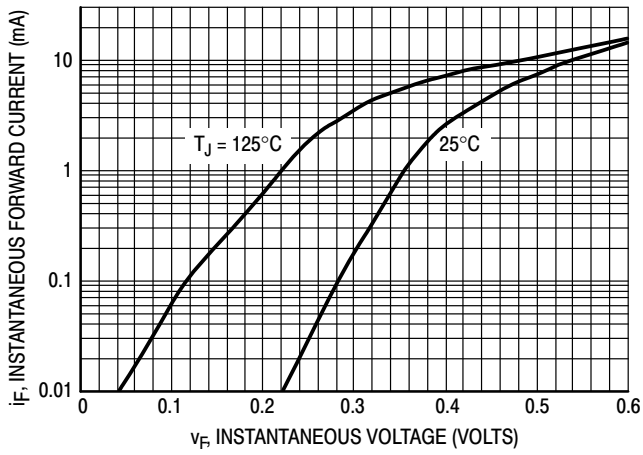

Figure 1. Maximum Forward Voltage

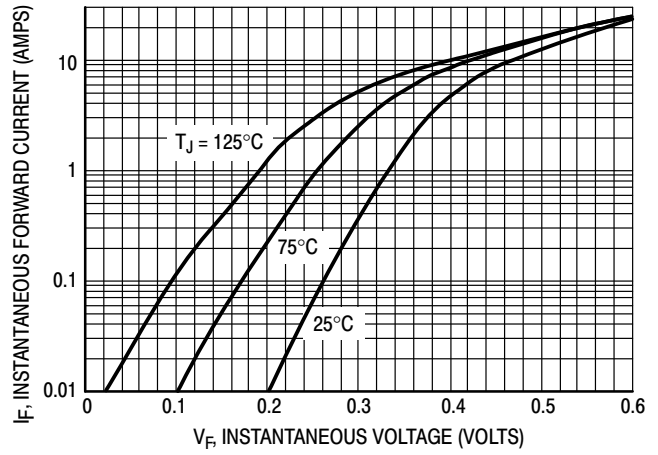

Figure 2. Typical Forward Voltage

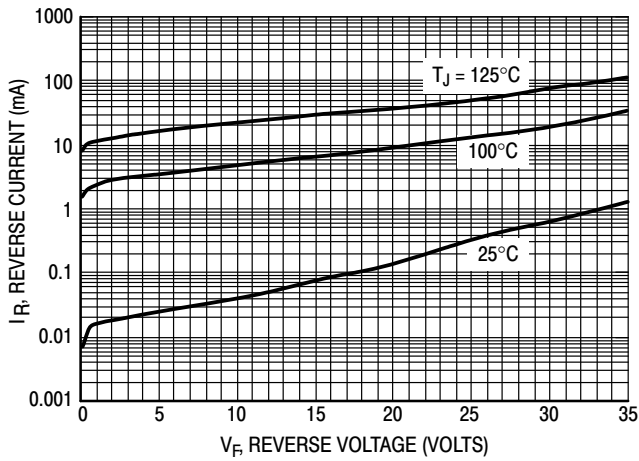

Figure 3. Maximum Reverse Current

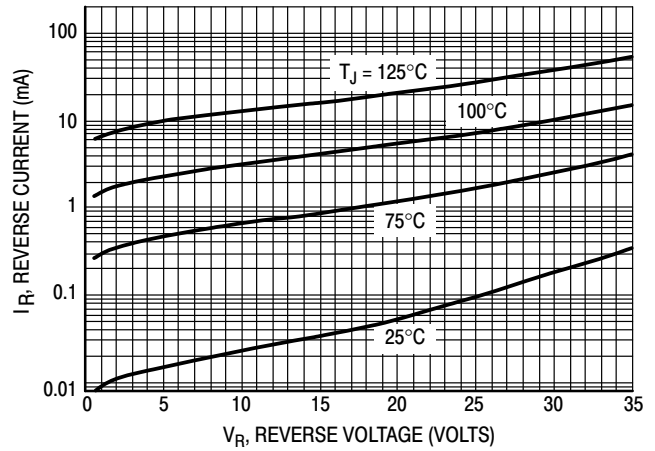

Figure 4. Typical Reverse Current

MBRD835L, SBRD8835L

TYPICAL CHARACTERISTICS

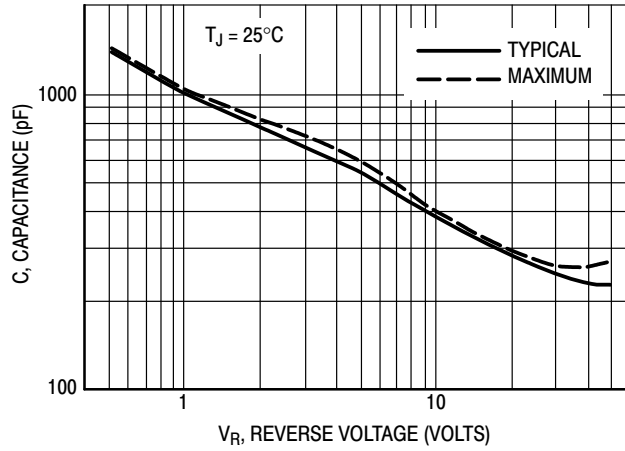

Figure 5. Maximum and Typical Capacitance

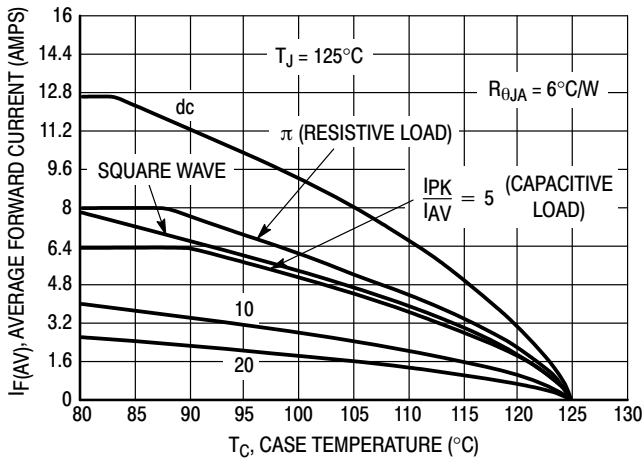

Figure 6. Current Derating, Infinite Heatsink

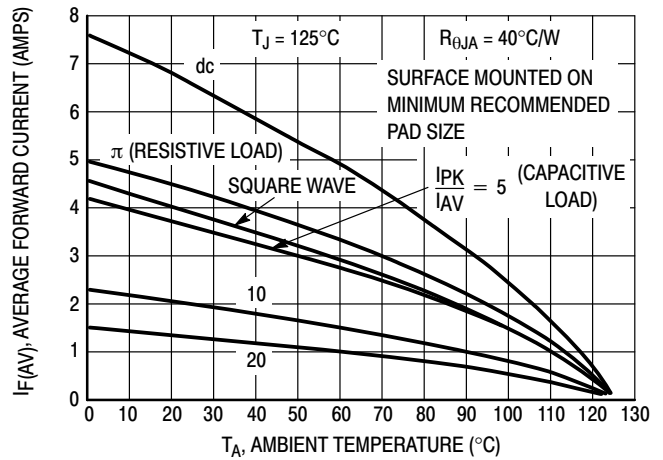

Figure 7. Current Derating

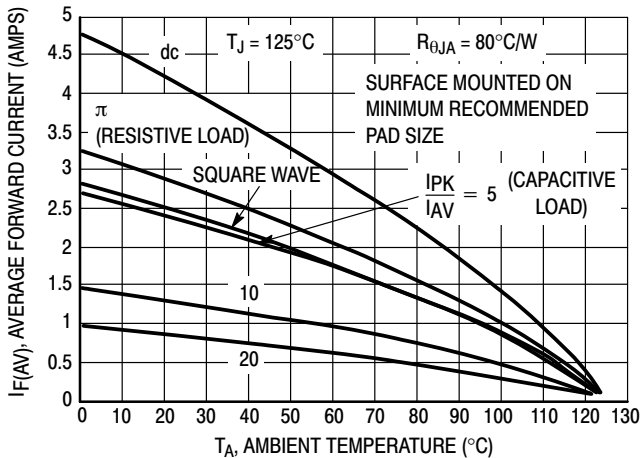

Figure 8. Current Derating, Free Air

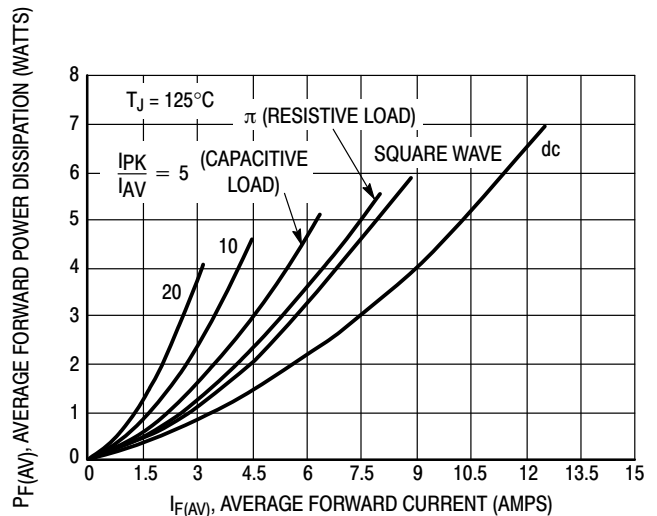
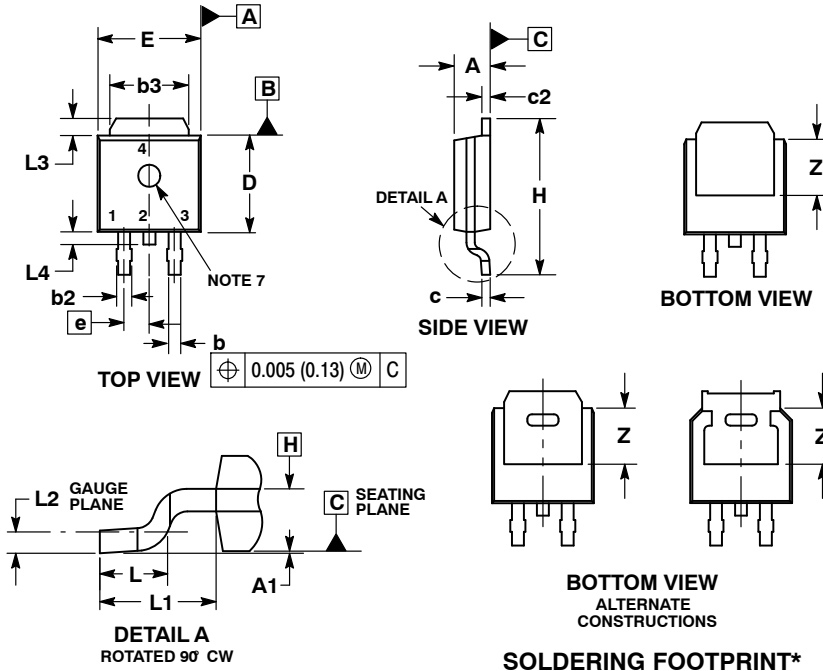

Figure 9. Forward Power Dissipation

MBRD835L, SBRD8835L

PACKAGE DIMENSIONS

DPAK (SINGLE GAUGE) CASE 369C ISSUE F



NOTES:

1. DIMENSIONING AND TOLERANCING PER ASME Y14.5M, 1994.
2. CONTROLLING DIMENSION: INCHES.
3. THERMAL PAD CONTOUR OPTIONAL WITHIN DIMENSIONS b3, L3 and Z.
4. DIMENSIONS D AND E DO NOT INCLUDE MOLD FLASH, PROTRUSIONS, OR BURRS. MOLD FLASH, PROTRUSIONS, OR GATE BURRS SHALL NOT EXCEED 0.006 INCHES PER SIDE.
5. DIMENSIONS D AND E ARE DETERMINED AT THE OUTERMOST EXTREMES OF THE PLASTIC BODY.
6. DATUMS A AND B ARE DETERMINED AT DATUM PLANE H.
7. OPTIONAL MOLD FEATURE.

DIM	INCHES		MILLIMETERS	
	MIN	MAX	MIN	MAX
A	0.086	0.094	2.18	2.38
A1	0.000	0.005	0.00	0.13
b	0.025	0.035	0.63	0.89
b2	0.028	0.045	0.72	1.14
b3	0.180	0.215	4.57	5.46
c	0.018	0.024	0.46	0.61
c2	0.018	0.024	0.46	0.61
D	0.235	0.245	5.97	6.22
E	0.250	0.265	6.35	6.73
e	0.090 BSC		2.29 BSC	
H	0.370	0.410	9.40	10.41
L	0.055	0.070	1.40	1.78
L1	0.114 REF		2.90 REF	
L2	0.020 BSC		0.51 BSC	
L3	0.035	0.050	0.89	1.27
L4	---	0.040	---	1.01
Z	0.155	---	3.93	---

SOLDERING FOOTPRINT*

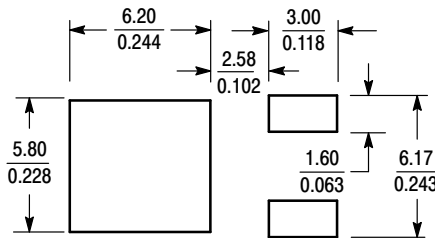

SCALE 3:1 $\left(\frac{\text{mm}}{\text{inches}}\right)$

*For additional information on our Pb-Free strategy and soldering details, please download the ON Semiconductor Soldering and Mounting Techniques Reference Manual, SOLDERRM/D.

ON Semiconductor and are trademarks of Semiconductor Components Industries, LLC dba ON Semiconductor or its subsidiaries in the United States and/or other countries. ON Semiconductor owns the rights to a number of patents, trademarks, copyrights, trade secrets, and other intellectual property. A listing of ON Semiconductor's product/patent coverage may be accessed at www.onsemi.com/site/pdf/Patent-Marking.pdf. ON Semiconductor reserves the right to make changes without further notice to any products herein. ON Semiconductor makes no warranty, representation or guarantee regarding the suitability of its products for any particular purpose, nor does ON Semiconductor assume any liability arising out of the application or use of any product or circuit, and specifically disclaims any and all liability, including without limitation special, consequential or incidental damages. Buyer is responsible for its products and applications using ON Semiconductor products, including compliance with all laws, regulations and safety requirements or standards, regardless of any support or applications information provided by ON Semiconductor. "Typical" parameters which may be provided in ON Semiconductor data sheets and/or specifications can and do vary in different applications and actual performance may vary over time. All operating parameters, including "Typicals" must be validated for each customer application by customer's technical experts. ON Semiconductor does not convey any license under its patent rights nor the rights of others. ON Semiconductor products are not designed, intended, or authorized for use as a critical component in life support systems or any FDA Class 3 medical devices or medical devices with a same or similar classification in a foreign jurisdiction or any devices intended for implantation in the human body. Should Buyer purchase or use ON Semiconductor products for any such unintended or unauthorized application, Buyer shall indemnify and hold ON Semiconductor and its officers, employees, subsidiaries, affiliates, and distributors harmless against all claims, costs, damages, and expenses, and reasonable attorney fees arising out of, directly or indirectly, any claim of personal injury or death associated with such unintended or unauthorized use, even if such claim alleges that ON Semiconductor was negligent regarding the design or manufacture of the part. ON Semiconductor is an Equal Opportunity/Affirmative Action Employer. This literature is subject to all applicable copyright laws and is not for resale in any manner.

PUBLICATION ORDERING INFORMATION

LITERATURE FULFILLMENT:
Email Requests to: orderlit@onsemi.com

TECHNICAL SUPPORT
North American Technical Support:
Voice Mail: 1 800-282-9855 Toll Free USA/Canada
Phone: 011 421 33 790 2910

Europe, Middle East and Africa Technical Support:
Phone: 00421 33 790 2910
For additional information, please contact your local Sales Representative