

# Octal Bidirectional Transceiver with 3-STATE Inputs/Outputs

## 74AC245, 74ACT245

### Description

The AC/ACT245 contains eight non-inverting bidirectional buffers with 3-STATE outputs and is intended for bus-oriented applications. Current sinking capability is 24 mA at both the A and B ports. The Transmit/Receive (T/R) input determines the direction of data flow through the bidirectional transceiver. Transmit (active-HIGH) enables data from A ports to B ports; Receive (active-LOW) enables data from B ports to A ports. The Output Enable input, when HIGH, disables both A and B ports by placing them in a HIGH Z condition.

### Features

- $I_{CC}$  and  $I_{OZ}$  Reduced by 50%
- Non-Inverting Buffer
- Bidirectional Data Path
- A and B Outputs Source/Sink 24 mA
- ACT245 has TTL-Compatible Inputs
- These are Pb-Free Devices

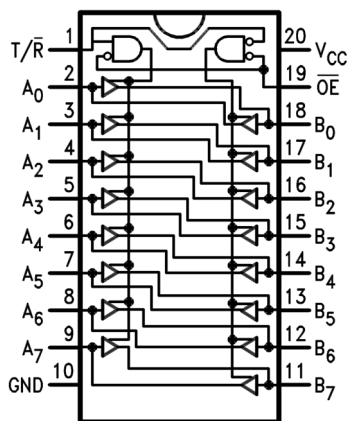
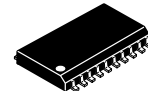
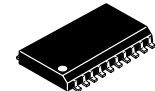

Figure 1. Connection Diagram



SOIC-20 WB  
CASE 751D-05



SOIC-20, 300 mils  
CASE 751BJ-01

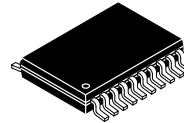

TSSOP-20 WB  
CASE 948E

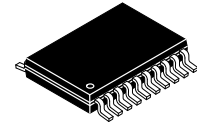

TSSOP20, 4.4x6.5  
CASE 948AQ-01

### MARKING DIAGRAM

#### SOIC-20

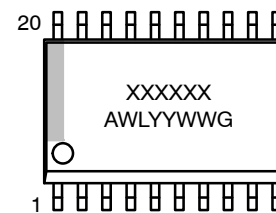

- XXXXXX = Specific Device Code
- A = Assembly Location
- WL = Wafer Lot
- YY = Year
- WW = Work Week
- G = Pb-Free Package

#### TSSOP-20

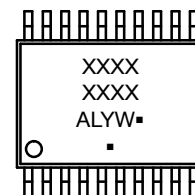

- XXXX = Specific Device Code
- A = Assembly Location
- L = Wafer Lot
- Y = Year
- W = Work Week
- = Pb-Free Package

(Note: Microdot may be in either location)

### ORDERING INFORMATION

See detailed ordering and shipping information in the package dimensions section on page 5 of this data sheet.

# 74AC245, 74ACT245

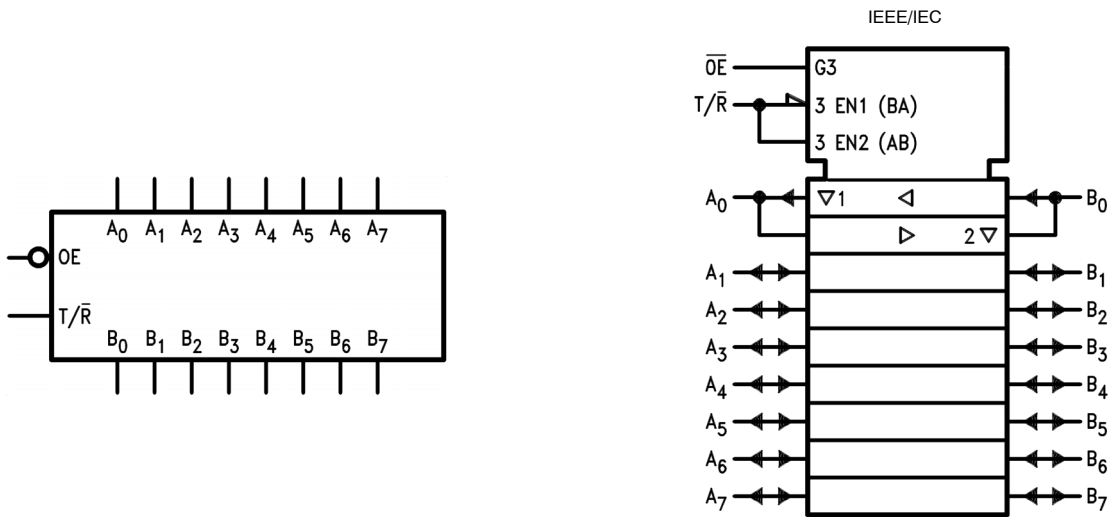

Figure 2. Logic Symbol

### PIN DESCRIPTIONS

| Pin Name         | Description                              |
|------------------|--|
| $\overline{OE}$  | Output Enable Input                      |
| $T/\overline{R}$ | Transmit / Receive Input                 |
| $A_0$ – $A_7$    | Side A 3–STATE Inputs or 3–STATE Outputs |
| $B_0$ – $B_7$    | Side B 3–STATE Inputs or 3–STATE Outputs |

### TRUTH TABLE

| Input           |    | Output              |
|-----------------|----|---------------------|
| $\overline{OE}$ | TR |                     |
| L               | L  | Bus B Data to Bus A |
| L               | H  | Bus A Data to Bus B |
| H               | X  | HIGH-Z State        |

H = HIGH Voltage Level  
L = LOW Voltage Level  
X = Immaterial

### ABSOLUTE MAXIMUM RATINGS

| Symbol                | Parameter                                    | Rating                 | Unit |
|-----------------------|--|------------------------|------|
| $V_{CC}$              | Supply Voltage                               | -0.5 to +6.5           | V    |
| $I_{IK}$              | DC Input Diode Current<br>$V_I = -0.5$ V     | -20                    | mA   |
|                       | $V_I = V_{CC} + 0.5$                         | +20                    | mA   |
| $V_I$                 | DC Input Voltage                             | -0.5 to $V_{CC} + 0.5$ | V    |
| $I_{OK}$              | DC Output Diode Current<br>$V_O = -0.5$ V    | -20                    | mA   |
|                       | $V_O = V_{CC} + 0.5$ V                       | +20                    | mA   |
| $V_O$                 | DC Output Voltage                            | -0.5 to $V_{CC} + 0.5$ | V    |
| $I_O$                 | DC Output Source or Sink Current             | $\pm 50$               | mA   |
| $I_{CC}$ or $I_{GND}$ | DC $V_{CC}$ or Ground Current per Output Pin | $\pm 50$               | mA   |
| $T_{STG}$             | Storage Temperature                          | -65 to +150            | °C   |
| $T_J$                 | Junction Temperature                         | 140                    | °C   |

Stresses exceeding those listed in the Maximum Ratings table may damage the device. If any of these limits are exceeded, device functionality should not be assumed, damage may occur and reliability may be affected.

# 74AC245, 74ACT245

## RECOMMENDED OPERATING CONDITIONS

| Symbol          | Parameter  | Rating               | Unit  |
|-----------------|--|----------------------|-------|
| V <sub>CC</sub> | Supply Voltage<br>AC   | 2.0 to 6.0           | V     |
|                 | ACT  | 4.5 to 5.5           | V     |
| V <sub>I</sub>  | Input Voltage  | 0 to V <sub>CC</sub> | V     |
| V <sub>O</sub>  | Output Voltage   | 0 to V <sub>CC</sub> | V     |
| T <sub>A</sub>  | Operating Temperature  | -40 to +85           | °C    |
| ΔV / Δt         | Minimum Input Edge Rate, AC Devices:<br>V <sub>IN</sub> from 30% to 70% of V <sub>CC</sub> , V <sub>CC</sub> @ 3.3 V, 4.5 V, 5.5 V | 125                  | mV/ns |
| ΔV / Δt         | Minimum Input Edge Rate, ACT Devices:<br>V <sub>IN</sub> from 0.8 V to 2.0 V, V <sub>CC</sub> @ 4.5 V, 5.5 V                       | 125                  | mV/ns |

Functional operation above the stresses listed in the Recommended Operating Ranges is not implied. Extended exposure to stresses beyond the Recommended Operating Ranges limits may affect device reliability.

## DC ELECTRICAL CHARACTERISTICS FOR AC

| Symbol                      | Parameter                                  | V <sub>CC</sub> (V) | Conditions  | T <sub>A</sub> = +25°C |                   | T <sub>A</sub> = -40°C to +85°C |  | Unit |
|-----------------------------|--|---------------------|---|------------------------|-------------------|---------------------------------|--|------|
|                             |  |                     |   | Typ.                   | Guaranteed Limits |                                 |  |      |
| V <sub>IH</sub>             | Minimum HIGH Level Input Voltage           | 3.0                 | V <sub>OUT</sub> = 0.1 V or V <sub>CC</sub> - 0.1 V   | 1.5                    | 2.1               | 2.1                             |  | V    |
|                             |  | 4.5                 |   | 2.25                   | 3.15              | 3.15                            |  |      |
|                             |  | 5.5                 |   | 2.75                   | 3.85              | 3.85                            |  |      |
| V <sub>IL</sub>             | Maximum LOW Level Input Voltage            | 3.0                 | V <sub>OUT</sub> = 0.1 V or V <sub>CC</sub> - 0.1 V   | 1.5                    | 0.9               | 0.9                             |  | V    |
|                             |  | 4.5                 |   | 2.25                   | 1.35              | 1.35                            |  |      |
|                             |  | 5.5                 |   | 2.75                   | 1.65              | 1.65                            |  |      |
| V <sub>OH</sub>             | Minimum HIGH Level Output Voltage          | 3.0                 | I <sub>OUT</sub> = -50 μA   | 2.99                   | 2.9               | 2.9                             |  | V    |
|                             |  | 4.5                 |   | 4.49                   | 4.4               | 4.4                             |  |      |
|                             |  | 5.5                 |   | 5.49                   | 5.4               | 5.4                             |  |      |
|                             |  | 3.0                 | V <sub>IN</sub> = V <sub>IL</sub> or V <sub>IH</sub> , I <sub>OH</sub> = -12 mA   | -                      | 2.56              | 2.46                            |  |      |
|                             |  | 4.5                 |   | -                      | 3.86              | 3.76                            |  |      |
|                             |  | 5.5                 |   | -                      | 4.86              | 4.76                            |  |      |
| V <sub>OL</sub>             | Maximum LOW Level Output Voltage           | 3.0                 | I <sub>OUT</sub> = 50 μA  | 0.002                  | 0.1               | 0.1                             |  | V    |
|                             |  | 4.5                 |   | 0.001                  | 0.1               | 0.1                             |  |      |
|                             |  | 5.5                 |   | 0.001                  | 0.1               | 0.1                             |  |      |
|                             |  | 3.0                 | V <sub>IN</sub> = V <sub>IL</sub> or V <sub>IH</sub> , I <sub>OL</sub> = 12 mA  | -                      | 0.36              | 0.44                            |  |      |
|                             |  | 4.5                 |   | -                      | 0.36              | 0.44                            |  |      |
|                             |  | 5.5                 |   | -                      | 0.36              | 0.44                            |  |      |
| I <sub>IN</sub><br>(Note 2) | Maximum Input Leakage Current              | 5.5                 | V <sub>I</sub> = V <sub>CC</sub> , GND  | -                      | ±0.1              | ±1.0                            |  | μA   |
| I <sub>OLD</sub>            | Minimum Dynamic Output Current<br>(Note 3) | 5.5                 | V <sub>OLD</sub> = 1.65 V Max.  | -                      | -                 | 75                              |  | mA   |
| I <sub>OHD</sub>            |  | 5.5                 | V <sub>OHD</sub> = 3.85 V Min.  | -                      | -                 | -75                             |  | mA   |
| I <sub>CC</sub><br>(Note 2) | Maximum Quiescent Supply Current           | 5.5                 | V <sub>IN</sub> = V <sub>CC</sub> or GND  | -                      | 4.0               | 40.0                            |  | μA   |
| I <sub>OZT</sub>            | Maximum I/O Leakage Current                | 5.5                 | V <sub>I</sub> (OE) = V <sub>IL</sub> , V <sub>IH</sub><br>V <sub>I</sub> = V <sub>CC</sub> , GND<br>V <sub>O</sub> = V <sub>CC</sub> , GND | -                      | ±0.3              | ±0.3                            |  | μA   |

Product parametric performance is indicated in the Electrical Characteristics for the listed test conditions, unless otherwise noted. Product performance may not be indicated by the Electrical Characteristics if operated under different conditions.

- All outputs loaded; thresholds on input associated with output under test.
- I<sub>IN</sub> and I<sub>CC</sub> @ 3.0 V are guaranteed to be less than or equal to the respective limit @ 5.5 V V<sub>CC</sub>.
- Maximum test duration 2.0 ms, one output loaded at a time.

## 74AC245, 74ACT245

### DC ELECTRICAL CHARACTERISTICS FOR ACT

| Symbol           | Parameter                                  | V <sub>CC</sub> (V) | Conditions  | T <sub>A</sub> = +25°C |                   | T <sub>A</sub> = -40°C to +85°C |  | Unit |
|------------------|--|---------------------|---|------------------------|-------------------|---------------------------------|--|------|
|                  |  |                     |   | Typ.                   | Guaranteed Limits |                                 |  |      |
|                  |  |                     |   |                        |                   |                                 |  |      |
| V <sub>IH</sub>  | Minimum HIGH Level Input Voltage           | 4.5                 | V <sub>OUT</sub> = 0.1 V or V <sub>CC</sub> - 0.1 V   | 1.5                    | 2.0               | 2.0                             |  | V    |
|                  |  | 5.5                 |   | 1.5                    | 2.0               | 2.0                             |  |      |
| V <sub>IL</sub>  | Maximum LOW Level Input Voltage            | 4.5                 | V <sub>OUT</sub> = 0.1 V or V <sub>CC</sub> - 0.1 V   | 1.5                    | 0.8               | 0.8                             |  | V    |
|                  |  | 5.5                 |   | 1.5                    | 0.8               | 0.8                             |  |      |
| V <sub>OH</sub>  | Minimum HIGH Level Output Voltage          | 4.5                 | I <sub>OUT</sub> = -50 μA   | 4.49                   | 4.4               | 4.4                             |  | V    |
|                  |  | 5.5                 |   | 5.49                   | 5.4               | 5.4                             |  |      |
|                  |  | 4.5                 | V <sub>IN</sub> = V <sub>IL</sub> or V <sub>IH</sub> ,<br>I <sub>OH</sub> = -24 mA  | -                      | 3.86              | 3.76                            |  |      |
|                  |  | 5.5                 | V <sub>IN</sub> = V <sub>IL</sub> or V <sub>IH</sub> , I <sub>OH</sub> = -24mA<br>(Note 4)  | -                      | 4.86              | 4.76                            |  |      |
| V <sub>OL</sub>  | Maximum LOW Level Output Voltage           | 4.5                 | I <sub>OUT</sub> = 50 μA  | 0.001                  | 0.1               | 0.1                             |  | V    |
|                  |  | 5.5                 |   | 0.001                  | 0.1               | 0.1                             |  |      |
|                  |  | 4.5                 | V <sub>IN</sub> = V <sub>IL</sub> or V <sub>IH</sub> , I <sub>OL</sub> = 24 mA  | -                      | 0.36              | 0.44                            |  |      |
|                  |  | 5.5                 | V <sub>IN</sub> = V <sub>IL</sub> or V <sub>IH</sub> , I <sub>OL</sub> = 24 mA<br>(Note 4)  | -                      | 0.36              | 0.44                            |  |      |
| I <sub>IN</sub>  | Maximum Input Leakage Current              | 5.5                 | V <sub>I</sub> = V <sub>CC</sub> , GND  | -                      | ±0.1              | ±1.0                            |  | μA   |
| I <sub>CCT</sub> | Maximum I <sub>CC</sub> /Input             | 5.5                 | V <sub>I</sub> = V <sub>CC</sub> - 2.1V   | 0.6                    | -                 | 1.5                             |  | mA   |
| I <sub>OLD</sub> | Minimum Dynamic Output Current<br>(Note 5) | 5.5                 | V <sub>OLD</sub> = 1.65 V Max.  | -                      | -                 | 75                              |  | mA   |
|                  |  | 5.5                 | V <sub>OH</sub> D = 3.85 V Min.   | -                      | -                 | -75                             |  |      |
| I <sub>CC</sub>  | Maximum Quiescent Supply Current           | 5.5                 | V <sub>IN</sub> = V <sub>CC</sub> or GND  | -                      | 4.0               | 40.0                            |  | μA   |
| I <sub>OZT</sub> | Maximum I/O Leakage Current                | 5.5                 | V <sub>I</sub> (OE) = V <sub>IL</sub> , V <sub>IH</sub> ; V <sub>I</sub> = V <sub>CC</sub> ,<br>GND; V <sub>O</sub> = V <sub>CC</sub> , GND | -                      | ±0.3              | ±3.0                            |  | μA   |

Product parametric performance is indicated in the Electrical Characteristics for the listed test conditions, unless otherwise noted. Product performance may not be indicated by the Electrical Characteristics if operated under different conditions.

4. All outputs loaded; thresholds on input associated with output under test.  
5. Maximum test duration 2.0 ms, one output loaded at a time.

### AC ELECTRICAL CHARACTERISTICS FOR AC

| Symbol           | Parameter   | V <sub>CC</sub> (V)<br>(Note 6) | T <sub>A</sub> = +25°C<br>C <sub>L</sub> = 50 pF |   |      | T <sub>A</sub> = -40°C to +85°C<br>C <sub>L</sub> = 50 pF |      | Unit |
|------------------|---|---------------------------------|--|---|------|---|------|------|
|                  |   |                                 | Min.   | Typ.  | Max. | Min.  | Max. |      |
|                  |   |                                 | t <sub>PLH</sub>                                 | Propagation Delay, A <sub>n</sub> to B <sub>n</sub> or B <sub>n</sub> to A <sub>n</sub> | 3.3  | 1.5   | 5.0  |      |
| 5.0              | 1.5   | 3.5                             |  |   | 6.5  | 1.0   | 7.0  |      |
| t <sub>PHL</sub> | Propagation Delay, A <sub>n</sub> to B <sub>n</sub> or B <sub>n</sub> to A <sub>n</sub> | 3.3                             | 1.5  | 5.0   | 8.5  | 1.0   | 9.0  | ns   |
|                  |   | 5.0                             | 1.5  | 3.5   | 6.0  | 1.0   | 7.0  |      |
| t <sub>PZH</sub> | Output Enable Time  | 3.3                             | 2.5  | 7.0   | 11.5 | 2.0   | 12.5 | ns   |
|                  |   | 5.0                             | 1.5  | 5.0   | 8.5  | 1.0   | 9.0  |      |
| t <sub>PZL</sub> | Output Enable Time  | 3.3                             | 2.5  | 7.5   | 12.0 | 2.0   | 13.5 | ns   |
|                  |   | 5.0                             | 1.5  | 5.5   | 9.0  | 1.0   | 9.5  |      |
| t <sub>PHZ</sub> | Output Disable Time   | 3.3                             | 2.0  | 6.5   | 12.0 | 1.0   | 12.5 | ns   |
|                  |   | 5.0                             | 1.5  | 5.5   | 9.0  | 1.0   | 10.0 |      |
| t <sub>PLZ</sub> | Output Disable Time   | 3.3                             | 2.0  | 7.0   | 11.5 | 1.5   | 13.0 | ns   |
|                  |   | 5.0                             | 1.5  | 5.5   | 9.0  | 1.0   | 10.0 |      |

Product parametric performance is indicated in the Electrical Characteristics for the listed test conditions, unless otherwise noted. Product performance may not be indicated by the Electrical Characteristics if operated under different conditions.

6. Voltage range 3.3 is 3.3 V ± 0.3 V. Voltage range 5.0 is 5.0 V ± 0.5 V.

# 74AC245, 74ACT245

## AC ELECTRICAL CHARACTERISTICS FOR ACT

| Symbol           | Parameter   | V <sub>CC</sub> (V)<br>(Note 7) | T <sub>A</sub> = +25°C<br>C <sub>L</sub> = 50 pF |      |      | T <sub>A</sub> = -40°C to +85°C<br>C <sub>L</sub> = 50 pF |      | Unit |
|------------------|---|---------------------------------|--|------|------|---|------|------|
|                  |   |                                 | Min.   | Typ. | Max. | Min.  | Max. |      |
| t <sub>PLH</sub> | Propagation Delay, A <sub>n</sub> to B <sub>n</sub> or B <sub>n</sub> to A <sub>n</sub> | 5.0                             | 1.5  | 4.0  | 7.5  | 1.5   | 8.0  | ns   |
| t <sub>PHL</sub> | Propagation Delay, A <sub>n</sub> to B <sub>n</sub> or B <sub>n</sub> to A <sub>n</sub> | 5.0                             | 1.5  | 4.0  | 8.0  | 1.0   | 9.0  | ns   |
| t <sub>PZH</sub> | Output Enable Time  | 5.0                             | 1.5  | 5.0  | 10.0 | 1.5   | 11.0 | ns   |
| t <sub>PZL</sub> | Output Enable Time  | 5.0                             | 1.5  | 5.5  | 10.0 | 1.5   | 12.0 | ns   |
| t <sub>PHZ</sub> | Output Disable Time   | 5.0                             | 1.5  | 5.5  | 10.0 | 1.0   | 11.0 | ns   |
| t <sub>PLZ</sub> | Output Disable Time   | 5.0                             | 2.0  | 5.0  | 10.0 | 1.5   | 11.0 | ns   |

Product parametric performance is indicated in the Electrical Characteristics for the listed test conditions, unless otherwise noted. Product performance may not be indicated by the Electrical Characteristics if operated under different conditions.

7. Voltage Range 5.0 is 5.0 V ±0.5 V.

## CAPACITANCE

| Symbol           | Parameter                     | Conditions              | Typ. | Unit |
|------------------|-------------------------------|-------------------------|------|------|
| C <sub>IN</sub>  | Input Capacitance             | V <sub>CC</sub> = OPEN  | 4.5  | pF   |
| C <sub>I/O</sub> | Input/Output Capacitance      | V <sub>CC</sub> = 5.0 V | 15.0 | pF   |
| C <sub>PD</sub>  | Power Dissipation Capacitance | V <sub>CC</sub> = 5.0 V | 45.0 | pF   |

## ORDERING INFORMATION

| Device       | Marking    | Package  | Shipping†          |
|--------------|------------|----------|--------------------|
| 74AC245MTC   | AC<br>245  | TSSOP-20 | 75 Units / Tube    |
| 74AC245MTCX  | AC<br>245  | TSSOP-20 | 2500 / Tape & Reel |
| 74AC245SCX   | AC245      | SOIC-20  | 1000 / Tape & Reel |
| 74ACT245MTCX | ACT<br>245 | TSSOP-20 | 2500 / Tape & Reel |
| 74ACT245SC   | ACT245     | SOIC-20  | 38 Units / Tube    |
| 74ACT245SCX  | ACT245     | SOIC-20  | 1000 / Tape & Reel |

†For information on tape and reel specifications, including part orientation and tape sizes, please refer to our Tape and Reel Packaging Specifications Brochure, [BRD8011/D](#).

**SOIC-20, 300 mils**  
**CASE 751BJ**  
**ISSUE O**

DATE 19 DEC 2008

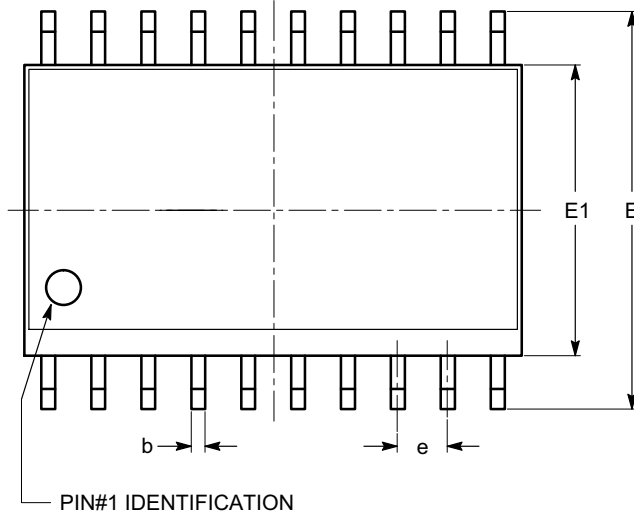

**TOP VIEW**

| SYMBOL     | MIN      | NOM   | MAX   |
|------------|----------|-------|-------|
| A          | 2.36     | 2.49  | 2.64  |
| A1         | 0.10     |       | 0.30  |
| A2         | 2.05     |       | 2.55  |
| b          | 0.31     | 0.41  | 0.51  |
| c          | 0.20     | 0.27  | 0.33  |
| D          | 12.60    | 12.80 | 13.00 |
| E          | 10.01    | 10.30 | 10.64 |
| E1         | 7.40     | 7.50  | 7.60  |
| e          | 1.27 BSC |       |       |
| h          | 0.25     |       | 0.75  |
| L          | 0.40     | 0.81  | 1.27  |
| $\theta$   | 0°       |       | 8°    |
| $\theta_1$ | 5°       |       | 15°   |

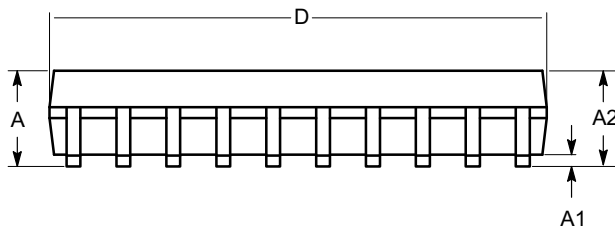

**SIDE VIEW**

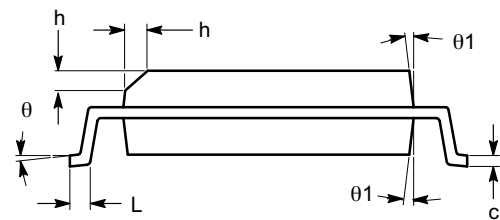

**END VIEW**

**Notes:**

- (1) All dimensions are in millimeters. Angles in degrees.
- (2) Complies with JEDEC MS-013.

|                         |                          |  |
|-------------------------|--------------------------|--|
| <b>DOCUMENT NUMBER:</b> | <b>98AON34287E</b>       | Electronic versions are uncontrolled except when accessed directly from the Document Repository. Printed versions are uncontrolled except when stamped "CONTROLLED COPY" in red. |
| <b>DESCRIPTION:</b>     | <b>SOIC-20, 300 MILS</b> | <b>PAGE 1 OF 1</b>   |

onsemi and ONSEMI are trademarks of Semiconductor Components Industries, LLC dba onsemi or its subsidiaries in the United States and/or other countries. onsemi reserves the right to make changes without further notice to any products herein. onsemi makes no warranty, representation or guarantee regarding the suitability of its products for any particular purpose, nor does onsemi assume any liability arising out of the application or use of any product or circuit, and specifically disclaims any and all liability, including without limitation special, consequential or incidental damages. onsemi does not convey any license under its patent rights nor the rights of others.



SCALE 1:1

SOIC-20 WB  
CASE 751D-05  
ISSUE H

DATE 22 APR 2015

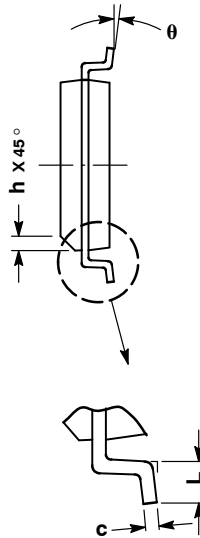
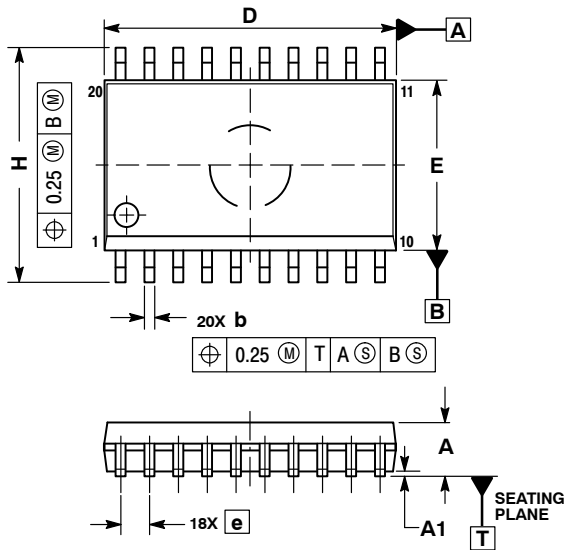

NOTES:

1. DIMENSIONS ARE IN MILLIMETERS.
2. INTERPRET DIMENSIONS AND TOLERANCES PER ASME Y14.5M, 1994.
3. DIMENSIONS D AND E DO NOT INCLUDE MOLD PROTRUSION.
4. MAXIMUM MOLD PROTRUSION 0.15 PER SIDE.
5. DIMENSION B DOES NOT INCLUDE DAMBAR PROTRUSION. ALLOWABLE PROTRUSION SHALL BE 0.13 TOTAL IN EXCESS OF B DIMENSION AT MAXIMUM MATERIAL CONDITION.

| DIM | MILLIMETERS |       |
|-----|-------------|-------|
|     | MIN         | MAX   |
| A   | 2.35        | 2.65  |
| A1  | 0.10        | 0.25  |
| b   | 0.35        | 0.49  |
| c   | 0.23        | 0.32  |
| D   | 12.65       | 12.95 |
| E   | 7.40        | 7.60  |
| e   | 1.27 BSC    |       |
| H   | 10.05       | 10.55 |
| h   | 0.25        | 0.75  |
| L   | 0.50        | 0.90  |
| θ   | 0°          | 7°    |

RECOMMENDED  
SOLDERING FOOTPRINT\*

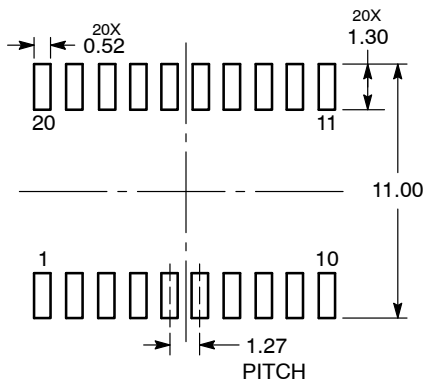

DIMENSIONS: MILLIMETERS

\*For additional information on our Pb-Free strategy and soldering details, please download the onsemi Soldering and Mounting Techniques Reference Manual, SOLDERRM/D.

GENERIC  
MARKING DIAGRAM\*

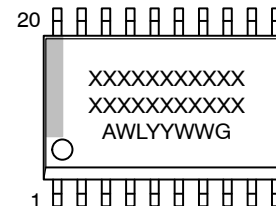

- XXXXXX = Specific Device Code
- A = Assembly Location
- WL = Wafer Lot
- YY = Year
- WW = Work Week
- G = Pb-Free Package

\*This information is generic. Please refer to device data sheet for actual part marking. Pb-Free indicator, "G" or microdot "•", may or may not be present. Some products may not follow the Generic Marking.

|                  |             |   |
|------------------|-------------|---|
| DOCUMENT NUMBER: | 98ASB42343B | Electronic versions are uncontrolled except when accessed directly from the Document Repository.<br>Printed versions are uncontrolled except when stamped "CONTROLLED COPY" in red. |
| DESCRIPTION:     | SOIC-20 WB  | PAGE 1 OF 1   |

onsemi and onsemi are trademarks of Semiconductor Components Industries, LLC dba onsemi or its subsidiaries in the United States and/or other countries. onsemi reserves the right to make changes without further notice to any products herein. onsemi makes no warranty, representation or guarantee regarding the suitability of its products for any particular purpose, nor does onsemi assume any liability arising out of the application or use of any product or circuit, and specifically disclaims any and all liability, including without limitation special, consequential or incidental damages. onsemi does not convey any license under its patent rights nor the rights of others.

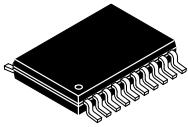

TSSOP-20 WB  
CASE 948E  
ISSUE D

DATE 17 FEB 2016

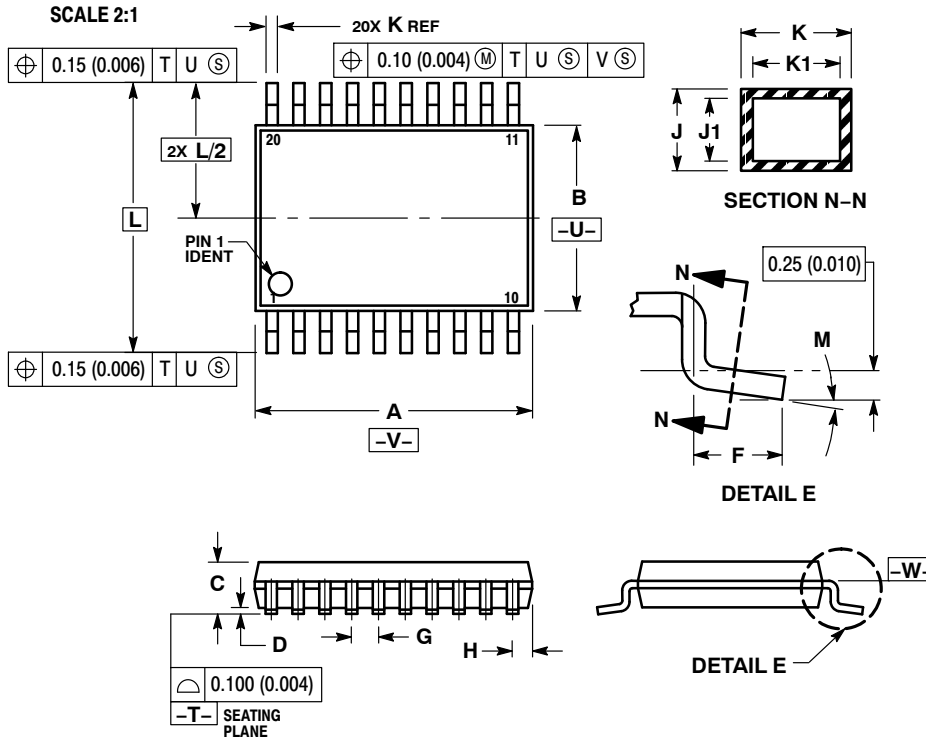

NOTES:

1. DIMENSIONING AND TOLERANCING PER ANSI Y14.5M, 1982.
2. CONTROLLING DIMENSION: MILLIMETER.
3. DIMENSION A DOES NOT INCLUDE MOLD FLASH, PROTRUSIONS OR GATE BURRS. MOLD FLASH OR GATE BURRS SHALL NOT EXCEED 0.15 (0.006) PER SIDE.
4. DIMENSION B DOES NOT INCLUDE INTERLEAD FLASH OR PROTRUSION. INTERLEAD FLASH OR PROTRUSION SHALL NOT EXCEED 0.25 (0.010) PER SIDE.
5. DIMENSION K DOES NOT INCLUDE DAMBAR PROTRUSION. ALLOWABLE DAMBAR PROTRUSION SHALL BE 0.08 (0.003) TOTAL IN EXCESS OF THE K DIMENSION AT MAXIMUM MATERIAL CONDITION.
6. TERMINAL NUMBERS ARE SHOWN FOR REFERENCE ONLY.
7. DIMENSION A AND B ARE TO BE DETERMINED AT DATUM PLANE -W-.

| DIM | MILLIMETERS |      | INCHES    |       |
|-----|-------------|------|-----------|-------|
|     | MIN         | MAX  | MIN       | MAX   |
| A   | 6.40        | 6.60 | 0.252     | 0.260 |
| B   | 4.30        | 4.50 | 0.169     | 0.177 |
| C   | ---         | 1.20 | ---       | 0.047 |
| D   | 0.05        | 0.15 | 0.002     | 0.006 |
| F   | 0.50        | 0.75 | 0.020     | 0.030 |
| G   | 0.65 BSC    |      | 0.026 BSC |       |
| H   | 0.27        | 0.37 | 0.011     | 0.015 |
| J   | 0.09        | 0.20 | 0.004     | 0.008 |
| J1  | 0.09        | 0.16 | 0.004     | 0.006 |
| K   | 0.19        | 0.30 | 0.007     | 0.012 |
| K1  | 0.19        | 0.25 | 0.007     | 0.010 |
| L   | 6.40 BSC    |      | 0.252 BSC |       |
| M   | 0°          | 8°   | 0°        | 8°    |

RECOMMENDED  
SOLDERING FOOTPRINT\*

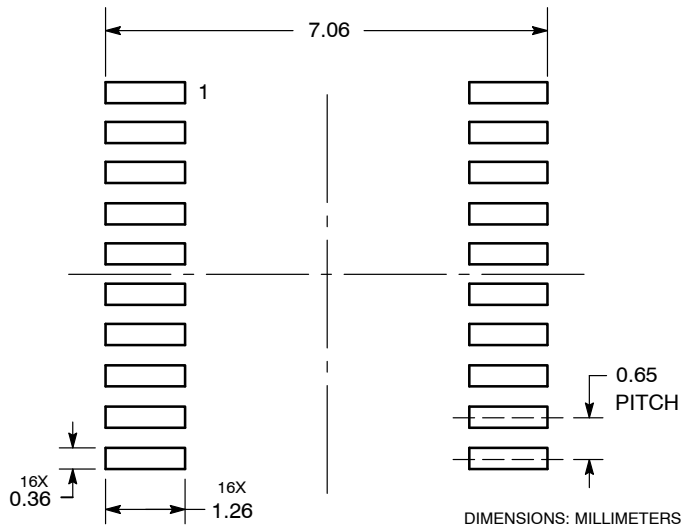

\*For additional information on our Pb-Free strategy and soldering details, please download the onsemi Soldering and Mounting Techniques Reference Manual, SOLDERRM/D.

GENERIC  
MARKING DIAGRAM\*

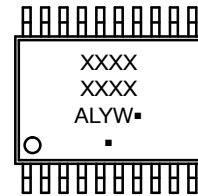

- A = Assembly Location
- L = Wafer Lot
- Y = Year
- W = Work Week
- = Pb-Free Package

(Note: Microdot may be in either location)

\*This information is generic. Please refer to device data sheet for actual part marking. Pb-Free indicator, "G" or microdot "▪", may or may not be present. Some products may not follow the Generic Marking.

|                  |             |  |
|------------------|-------------|--|
| DOCUMENT NUMBER: | 98ASH70169A | Electronic versions are uncontrolled except when accessed directly from the Document Repository. Printed versions are uncontrolled except when stamped "CONTROLLED COPY" in red. |
| DESCRIPTION:     | TSSOP-20 WB | PAGE 1 OF 1  |

onsemi and onsemi are trademarks of Semiconductor Components Industries, LLC dba onsemi or its subsidiaries in the United States and/or other countries. onsemi reserves the right to make changes without further notice to any products herein. onsemi makes no warranty, representation or guarantee regarding the suitability of its products for any particular purpose, nor does onsemi assume any liability arising out of the application or use of any product or circuit, and specifically disclaims any and all liability, including without limitation special, consequential or incidental damages. onsemi does not convey any license under its patent rights nor the rights of others.



**TSSOP20, 4.4x6.5**  
**CASE 948AQ**  
**ISSUE A**

DATE 19 MAR 2009

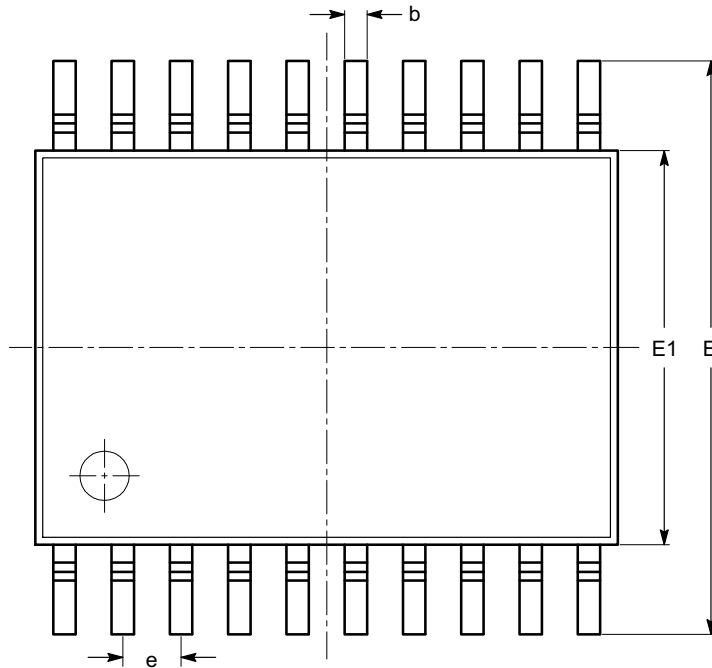

**TOP VIEW**

| SYMBOL   | MIN      | NOM  | MAX  |
|----------|----------|------|------|
| A        |          |      | 1.20 |
| A1       | 0.05     |      | 0.15 |
| A2       | 0.80     |      | 1.05 |
| b        | 0.19     |      | 0.30 |
| c        | 0.09     |      | 0.20 |
| D        | 6.40     | 6.50 | 6.60 |
| E        | 6.30     | 6.40 | 6.50 |
| E1       | 4.30     | 4.40 | 4.50 |
| e        | 0.65 BSC |      |      |
| L        | 0.45     | 0.60 | 0.75 |
| L1       | 1.00 REF |      |      |
| $\theta$ | 0°       |      | 8°   |

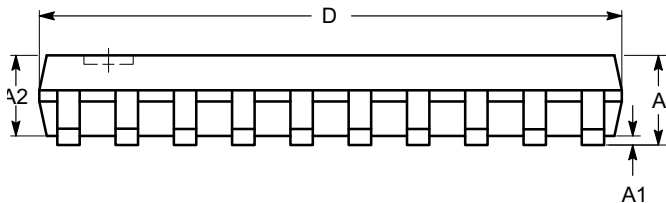

**SIDE VIEW**

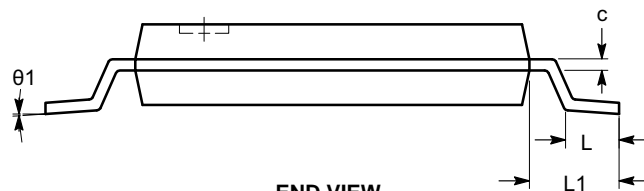

**END VIEW**

**Notes:**

- (1) All dimensions are in millimeters. Angles in degrees.
- (2) Complies with JEDEC MO-153.

|                         |                         |   |
|-------------------------|-------------------------|---|
| <b>DOCUMENT NUMBER:</b> | <b>98AON34453E</b>      | Electronic versions are uncontrolled except when accessed directly from the Document Repository.<br>Printed versions are uncontrolled except when stamped "CONTROLLED COPY" in red. |
| <b>DESCRIPTION:</b>     | <b>TSSOP20, 4.4X6.5</b> | <b>PAGE 1 OF 1</b>  |

onsemi and ONSEMI are trademarks of Semiconductor Components Industries, LLC dba onsemi or its subsidiaries in the United States and/or other countries. onsemi reserves the right to make changes without further notice to any products herein. onsemi makes no warranty, representation or guarantee regarding the suitability of its products for any particular purpose, nor does onsemi assume any liability arising out of the application or use of any product or circuit, and specifically disclaims any and all liability, including without limitation special, consequential or incidental damages. onsemi does not convey any license under its patent rights nor the rights of others.

**onsemi**, **Onsemi**, and other names, marks, and brands are registered and/or common law trademarks of Semiconductor Components Industries, LLC dba "**onsemi**" or its affiliates and/or subsidiaries in the United States and/or other countries. **onsemi** owns the rights to a number of patents, trademarks, copyrights, trade secrets, and other intellectual property. A listing of **onsemi**'s product/patent coverage may be accessed at [www.onsemi.com/site/pdf/Patent-Marking.pdf](http://www.onsemi.com/site/pdf/Patent-Marking.pdf). **onsemi** reserves the right to make changes at any time to any products or information herein, without notice. The information herein is provided "as-is" and **onsemi** makes no warranty, representation or guarantee regarding the accuracy of the information, product features, availability, functionality, or suitability of its products for any particular purpose, nor does **onsemi** assume any liability arising out of the application or use of any product or circuit, and specifically disclaims any and all liability, including without limitation special, consequential or incidental damages. Buyer is responsible for its products and applications using **onsemi** products, including compliance with all laws, regulations and safety requirements or standards, regardless of any support or applications information provided by **onsemi**. "Typical" parameters which may be provided in **onsemi** data sheets and/or specifications can and do vary in different applications and actual performance may vary over time. All operating parameters, including "Typicals" must be validated for each customer application by customer's technical experts. **onsemi** does not convey any license under any of its intellectual property rights nor the rights of others. **onsemi** products are not designed, intended, or authorized for use as a critical component in life support systems or any FDA Class 3 medical devices or medical devices with a same or similar classification in a foreign jurisdiction or any devices intended for implantation in the human body. Should Buyer purchase or use **onsemi** products for any such unintended or unauthorized application, Buyer shall indemnify and hold **onsemi** and its officers, employees, subsidiaries, affiliates, and distributors harmless against all claims, costs, damages, and expenses, and reasonable attorney fees arising out of, directly or indirectly, any claim of personal injury or death associated with such unintended or unauthorized use, even if such claim alleges that **onsemi** was negligent regarding the design or manufacture of the part. **onsemi** is an Equal Opportunity/Affirmative Action Employer. This literature is subject to all applicable copyright laws and is not for resale in any manner.

## ADDITIONAL INFORMATION

### TECHNICAL PUBLICATIONS:

Technical Library: [www.onsemi.com/design/resources/technical-documentation](http://www.onsemi.com/design/resources/technical-documentation)  
onsemi Website: [www.onsemi.com](http://www.onsemi.com)

### ONLINE SUPPORT: [www.onsemi.com/support](http://www.onsemi.com/support)

For additional information, please contact your local Sales Representative at [www.onsemi.com/support/sales](http://www.onsemi.com/support/sales)