

IGBT for Automotive Applications

650 V, 40 A

AFGB40T65RQDN

Using novel field stop IGBT technology, onsemi's new series of FS4 IGBTs offer the optimum performance for automotive applications. This technology is Short circuit rated and offers high figure of merit with low conduction and switching losses.

Features

- Maximum Junction Temperature: $T_J = 175^\circ\text{C}$
- Positive Temperature Coefficient for Easy Parallel Operation
- High Current Capability
- Low Saturation Voltage: $V_{CE(Sat)} = 1.55\text{ V (Typ.) @ } I_C = 40\text{ A}$
- 100% of the Parts Tested for ILM (Note 2)
- High Input Impedance
- Fast Switching
- Tightened Parameter Distribution
- This Device is Pb-Free and RoHS Compliant

Typical Applications

- E-compressor for HEV/EV
- PTC Heater for HEV/EV

BV_{CES}	$V_{CE(sat)}$ TYP	I_C
650 V	1.55 V	40 A

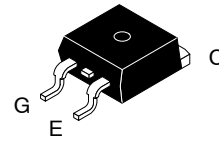
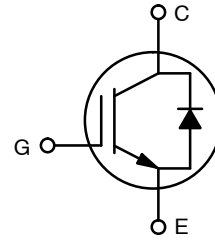

D2PAK
3 LEAD
CASE 418AJ

MARKING DIAGRAM

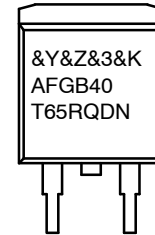

- &Y = Logo
- &Z = Assembly Plant Code
- &3 = 3-Digit Date Code
- &K = 2-Digit Lot Traceability Code
- AFGB40T65RQDN = Specific Device Code

ORDERING INFORMATION

Device	Package	Shipping†
AFGB40T65RQDN	D2PAK (TO-263)	800 Units / Tape & Reel

†For information on tape and reel specifications, including part orientation and tape sizes, please refer to our Tape and Reel Packaging Specification Brochure, BRD8011/D.

AFGB40T65RQDN

MAXIMUM RATINGS ($T_C = 25^\circ\text{C}$ unless otherwise stated)

Parameter	Symbol	Value	Unit
Collector to Emitter Voltage	V_{CES}	650	V
Gate to Emitter Voltage Transient Gate to Emitter Voltage $T_{\text{pulse}} = 5 \mu\text{s}$, $D < 0.10$	V_{GES}	± 20 ± 30	V
Collector Current (Note 1) @ $T_C = 25^\circ\text{C}$ @ $T_C = 100^\circ\text{C}$	I_C	68 40	A
Pulsed Collector Current (Note 2)	I_{LM}	160	A
Pulsed Collector Current (Note 3)	I_{CM}	160	A
Diode Forward Current (Note 1) @ $T_C = 25^\circ\text{C}$ @ $T_C = 100^\circ\text{C}$	I_F	68 40	A
Pulsed Diode Maximum Forward Current	I_{FM}	160	A
Non-Repetitive Forward Surge Current (Half-Sine Pulse, $t_p = 8.3 \text{ ms}$, $T_C = 25^\circ\text{C}$) (Half-Sine Pulse, $t_p = 8.3 \text{ ms}$, $T_C = 150^\circ\text{C}$)	$I_{F, SM}$	136 118	A
Short Circuit Withstand Time $V_{GE} = 15 \text{ V}$, $V_{CC} = 400 \text{ V}$, $T_C = 150^\circ\text{C}$	T_{SC}	5	μs
Maximum Power Dissipation @ $T_C = 25^\circ\text{C}$ @ $T_C = 100^\circ\text{C}$	P_D	339.37 169.68	W
Operating Junction and Storage Temperature Range	T_J, T_{STG}	-55 to +175	$^\circ\text{C}$
Maximum Lead Temp. for Soldering Purposes, 1/8" from case for 5 seconds	T_L	265	$^\circ\text{C}$

Stresses exceeding those listed in the Maximum Ratings table may damage the device. If any of these limits are exceeded, device functionality should not be assumed, damage may occur and reliability may be affected.

- Value limited by bond wire.
- $V_{CC} = 400 \text{ V}$, $V_{GE} = 15 \text{ V}$, $I_C = 120 \text{ A}$, $R_G = 100 \Omega$, Inductive Load, 100% Tested.
- Repetitive rating: pulse width limited by max. Junction temperature.

THERMAL RESISTANCE RATINGS

Parameter	Symbol	Min	Typ	Max	Unit
Thermal Resistance Junction-to-Case, for IGBT	$R_{\theta JC}$	-	0.34	0.44	$^\circ\text{C/W}$
Thermal Resistance Junction-to-Case, for Diode	$R_{\theta JC}$	-	0.79	1.03	
Thermal Resistance Junction-to-Ambient	$R_{\theta JA}$	-	-	40	

AFGB40T65RQDN

ELECTRICAL CHARACTERISTICS (T_J = 25°C unless otherwise stated)

Parameter	Symbol	Test Condition	Min	Typ	Max	Unit
-----------	--------	----------------	-----	-----	-----	------

OFF CHARACTERISTICS

Collector-to-Emitter Breakdown Voltage, Gate-Emitter Short-Circuited	BV _{CES}	V _{GE} = 0 V, I _C = 1 mA	650	-	-	V
Temperature Coefficient of Breakdown Voltage	ΔBV _{CES} /ΔT _J	V _{GE} = 0 V, I _C = 1 mA	-	0.62	-	V/°C
Collector-Emitter Cut-Off Current, Gate-Emitter Short-Circuited	I _{CES}	V _{CE} = V _{CES} , V _{GE} = 0 V	-	-	30	μA
Gate Leakage Current, Collector-Emitter Short-Circuited	I _{GES}	V _{GE} = V _{GES} , V _{CE} = 0 V	-	-	±400	nA

ON CHARACTERISTICS

Gate-Emitter Threshold Voltage	V _{GE(th)}	V _{GE} = V _{CE} , I _C = 40 mA	3.75	4.90	6.05	V
Collector-Emitter Saturation Voltage	V _{CE(sat)}	I _C = 40 A, V _{GE} = 15 V, T _J = 25°C	-	1.55	1.82	V
		I _C = 40 A, V _{GE} = 15 V, T _J = 175°C	-	1.90	-	V

DYNAMIC CHARACTERISTICS

Input Capacitance	C _{ies}	V _{CE} = 30 V, V _{GE} = 0 V, f = 1 MHz	-	2100	-	pF
Output Capacitance	C _{oes}		-	71	-	
Reverse Transfer Capacitance	C _{res}		-	9	-	
Gate Resistance	R _g	FREQ = 1 MHz	-	14	-	Ω
Gate Charge Total	Q _g	V _{CE} = 400 V, I _C = 40 A, V _{GE} = 15 V	-	51	-	nC
Gate-Emitter Charge	Q _{ge}		-	17	-	
Gate-Collector Charge	Q _{gc}		-	14	-	

SWITCHING CHARACTERISTICS, INDUCTIVE LOAD

Turn-On Delay Time	t _{d(on)}	T _J = 25°C, V _{CC} = 400 V, I _C = 20 A, R _g = 3 Ω, V _{GE} = 15 V, Inductive Load	-	21	-	ns	
Rise Time	t _r		-	21	-		
Turn-Off Delay Time	t _{d(off)}		-	77	-		
Fall Time	t _f		-	94	-		
Turn-On Switching Loss	E _{on}		T _J = 25°C, V _{CC} = 400 V, I _C = 40 A, R _g = 3 Ω, V _{GE} = 15 V, Inductive Load	-	0.47	-	mJ
Turn-Off Switching Loss	E _{off}			-	0.42	-	
Total Switching Loss	E _{ts}			-	0.89	-	
Turn-On Delay Time	t _{d(on)}	T _J = 25°C, V _{CC} = 400 V, I _C = 40 A, R _g = 3 Ω, V _{GE} = 15 V, Inductive Load		-	22	-	ns
Rise Time	t _r			-	45	-	
Turn-Off Delay Time	t _{d(off)}			-	66	-	
Fall Time	t _f			-	74	-	
Turn-On Switching Loss	E _{on}		T _J = 175°C, V _{CC} = 400 V, I _C = 20 A, R _g = 3 Ω, V _{GE} = 15 V, Inductive Load	-	1.18	-	mJ
Turn-Off Switching Loss	E _{off}			-	0.75	-	
Total Switching Loss	E _{ts}			-	1.93	-	
Turn-On Delay Time	t _{d(on)}	T _J = 175°C, V _{CC} = 400 V, I _C = 20 A, R _g = 3 Ω, V _{GE} = 15 V, Inductive Load		-	20	-	ns
Rise Time	t _r			-	24	-	
Turn-Off Delay Time	t _{d(off)}			-	96	-	
Fall Time	t _f			-	192	-	
Turn-On Switching Loss	E _{on}		T _J = 175°C, V _{CC} = 400 V, I _C = 20 A, R _g = 3 Ω, V _{GE} = 15 V, Inductive Load	-	0.79	-	mJ
Turn-Off Switching Loss	E _{off}			-	0.88	-	
Total Switching Loss	E _{ts}			-	1.67	-	

AFGB40T65RQDN

ELECTRICAL CHARACTERISTICS ($T_J = 25^\circ\text{C}$ unless otherwise stated) (continued)

Parameter	Symbol	Test Condition	Min	Typ	Max	Unit
-----------	--------	----------------	-----	-----	-----	------

SWITCHING CHARACTERISTICS, INDUCTIVE LOAD

Turn-On Delay Time	$t_{d(on)}$	$T_J = 175^\circ\text{C}$, $V_{CC} = 400\text{ V}$, $I_C = 40\text{ A}$, $R_g = 3\ \Omega$, $V_{GE} = 15\text{ V}$, Inductive Load	–	24	–	ns
Rise Time	t_r		–	51	–	
Turn-Off Delay Time	$t_{d(off)}$		–	80	–	
Fall Time	t_f		–	152	–	
Turn-On Switching Loss	E_{on}		–	1.71	–	mJ
Turn-Off Switching Loss	E_{off}		–	1.37	–	
Total Switching Loss	E_{ts}		–	3.08	–	

DIODE CHARACTERISTICS

Diode Forward Voltage	V_F	$T_J = 25^\circ\text{C}$, $I_F = 40\text{ A}$	–	1.68	2.10	V
		$T_J = 175^\circ\text{C}$, $I_F = 40\text{ A}$	–	1.75	–	

DIODE SWITCHING CHARACTERISTIC, INDUCTIVE LOAD

Reverse Recovery Energy	E_{REC}	$T_J = 25^\circ\text{C}$, $V_R = 400\text{ V}$, $I_F = 20\text{ A}$, $di_F/dt = 1000\text{ A}/\mu\text{s}$	–	59	–	μJ
Diode Reverse Recovery Time	T_{rr}		–	40	–	ns
Diode Reverse Recovery Charge	Q_{rr}		–	413	–	nC
Reverse Recovery Energy	E_{REC}	$T_J = 25^\circ\text{C}$, $V_R = 400\text{ V}$, $I_F = 40\text{ A}$, $di_F/dt = 1000\text{ A}/\mu\text{s}$	–	85	–	μJ
Diode Reverse Recovery Time	T_{rr}		–	52	–	ns
Diode Reverse Recovery Charge	Q_{rr}		–	543	–	nC
Reverse Recovery Energy	E_{REC}	$T_J = 175^\circ\text{C}$, $V_R = 400\text{ V}$, $I_F = 20\text{ A}$, $di_F/dt = 1000\text{ A}/\mu\text{s}$	–	203	–	μJ
Diode Reverse Recovery Time	T_{rr}		–	73	–	ns
Diode Reverse Recovery Charge	Q_{rr}		–	984	–	nC
Reverse Recovery Energy	E_{REC}	$T_J = 175^\circ\text{C}$, $V_R = 400\text{ V}$, $I_F = 40\text{ A}$, $di_F/dt = 1000\text{ A}/\mu\text{s}$	–	282	–	μJ
Diode Reverse Recovery Time	T_{rr}		–	96	–	ns
Diode Reverse Recovery Charge	Q_{rr}		–	1334	–	nC

Product parametric performance is indicated in the Electrical Characteristics for the listed test conditions, unless otherwise noted. Product performance may not be indicated by the Electrical Characteristics if operated under different conditions.

AFGB40T65RQDN

TYPICAL CHARACTERISTICS

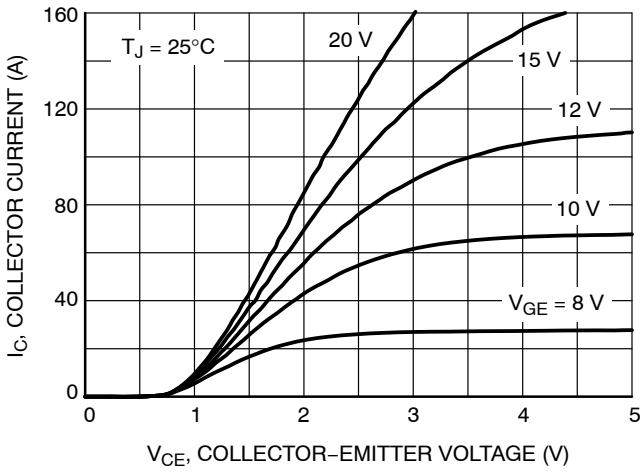

Figure 1. Typical Output Characteristics (25°C)

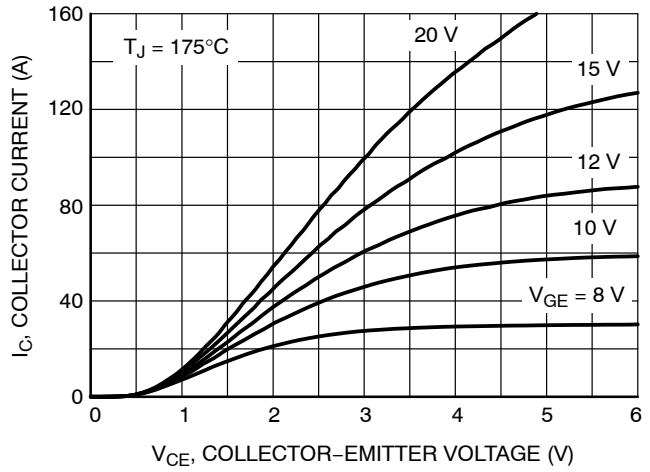

Figure 2. Typical Output Characteristics (175°C)

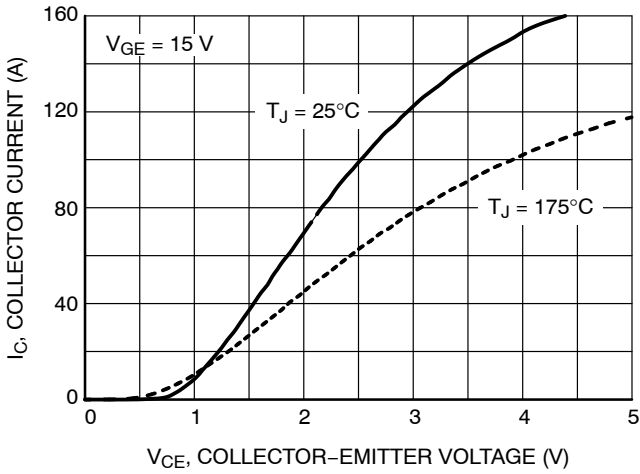

Figure 3. Typical Saturation Voltage Characteristics

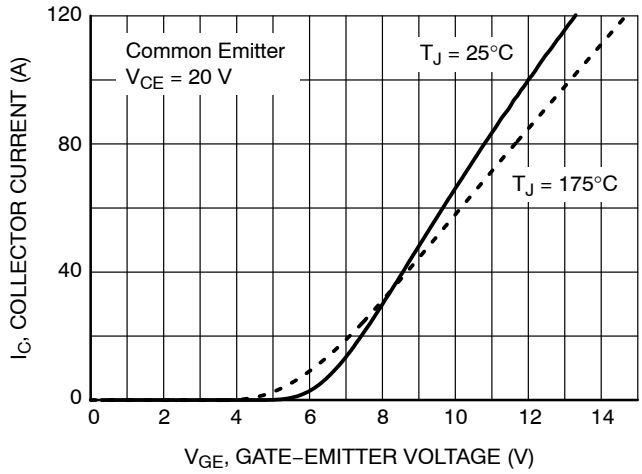

Figure 4. Typical Transfer Characteristics

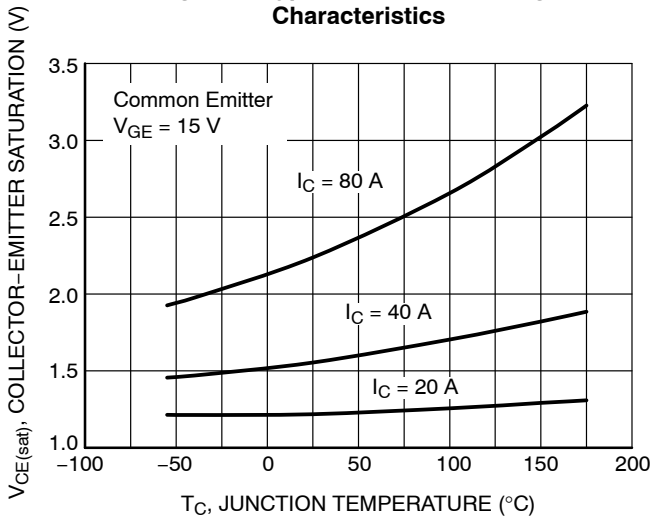

Figure 5. Saturation Voltage vs. Case

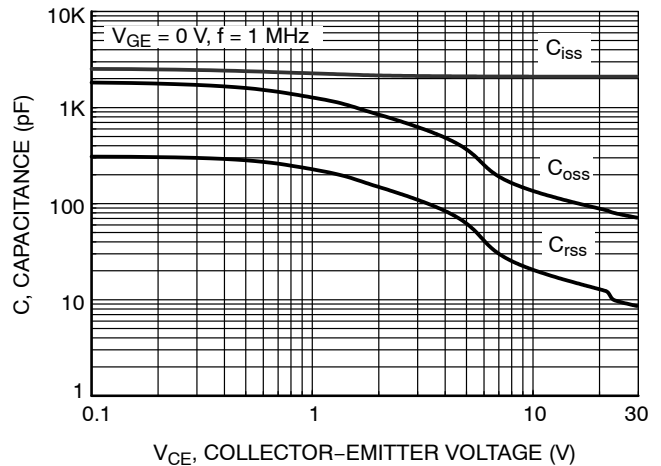

Figure 6. Capacitance Characteristics

AFGB40T65RQDN

TYPICAL CHARACTERISTICS (Continued)

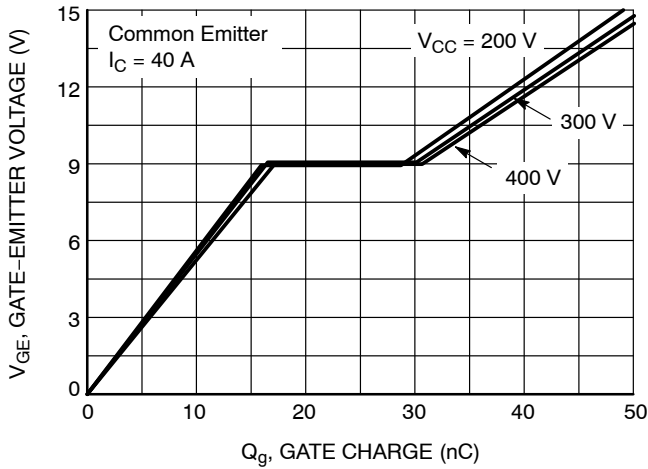

Figure 7. Gate Charge Characteristics

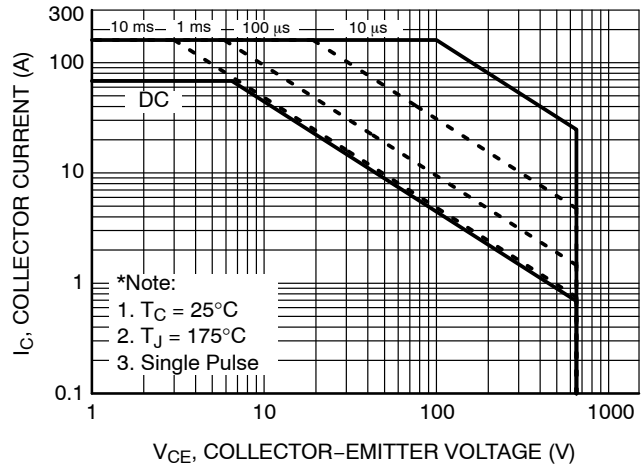

Figure 8. SOA Characteristics

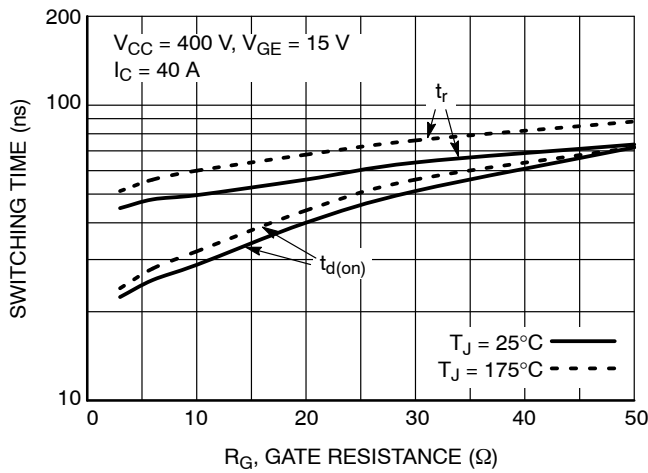

Figure 9. Turn-On Characteristics vs. Gate Resistance

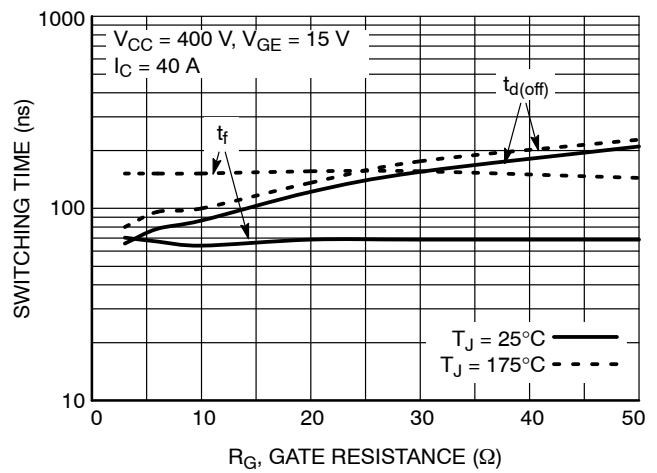

Figure 10. Turn-Off Characteristics vs. Gate Resistance

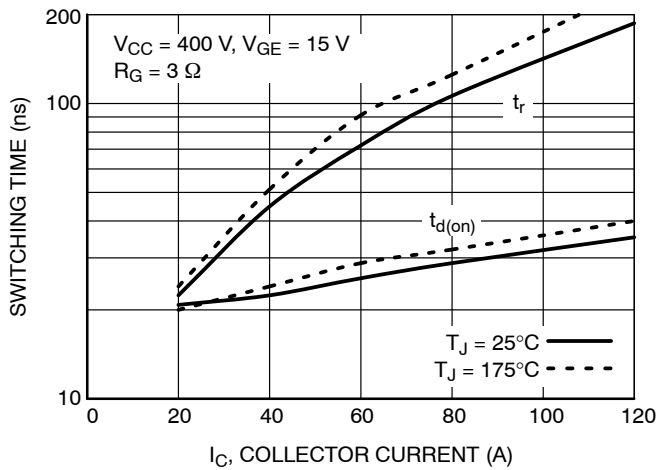

Figure 11. Turn-On Characteristics vs. Collector Current

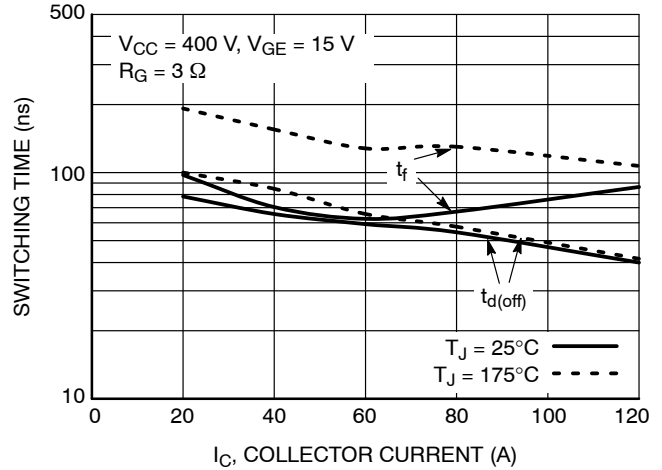

Figure 12. Turn-Off Characteristics vs. Collector Current

AFGB40T65RQDN

TYPICAL CHARACTERISTICS (Continued)

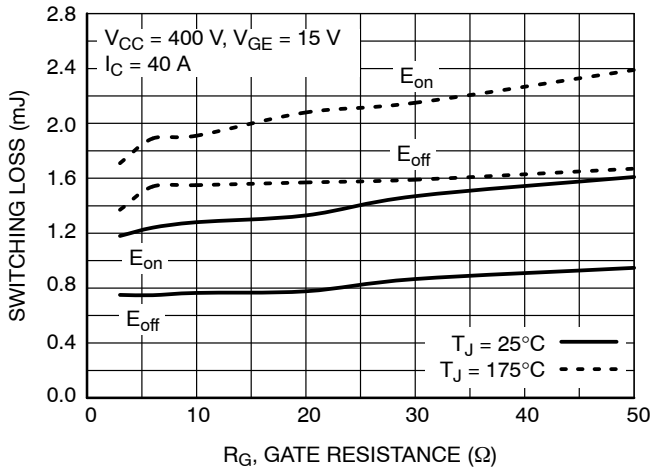

Figure 13. Switching Loss vs. Gate Resistance

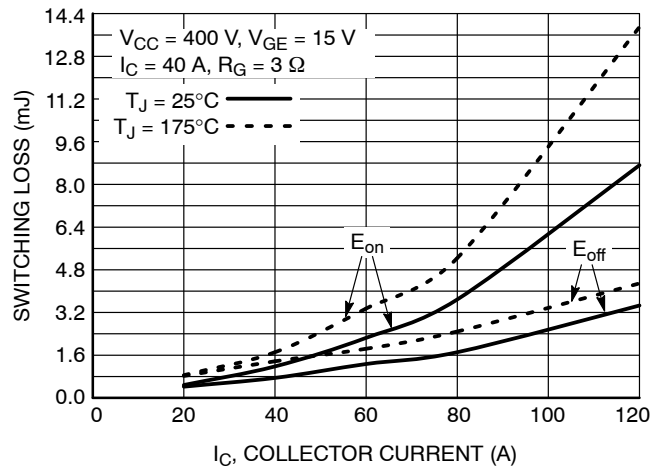

Figure 14. Switching Loss vs. Collector Current

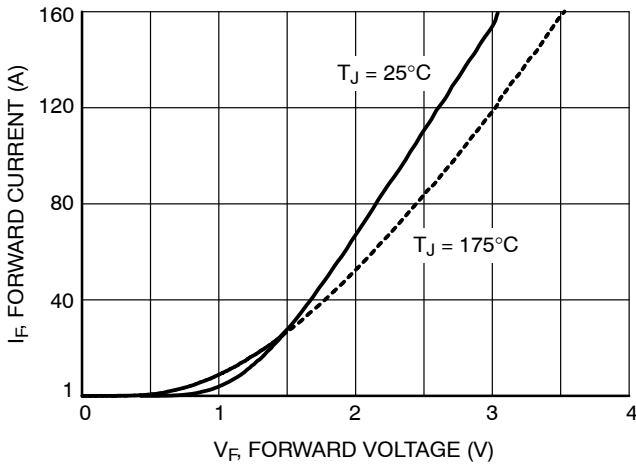

Figure 15. Forward Characteristics

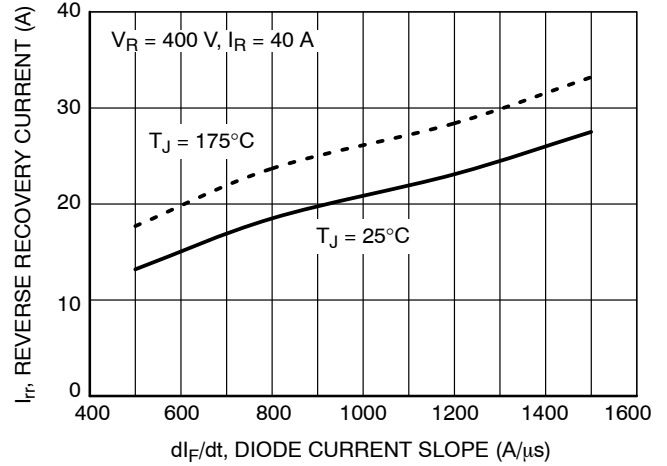

Figure 16. Reverse Recovery Current

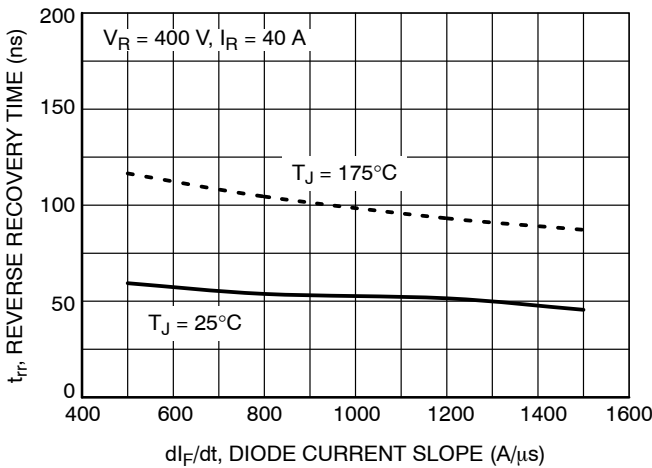

Figure 17. Reverse Recovery Time

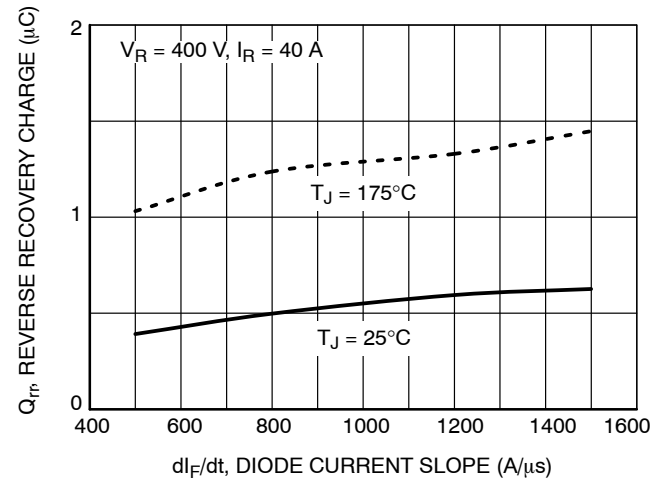

Figure 18. Stored Charge

AFGB40T65RQDN

TYPICAL CHARACTERISTICS (Continued)

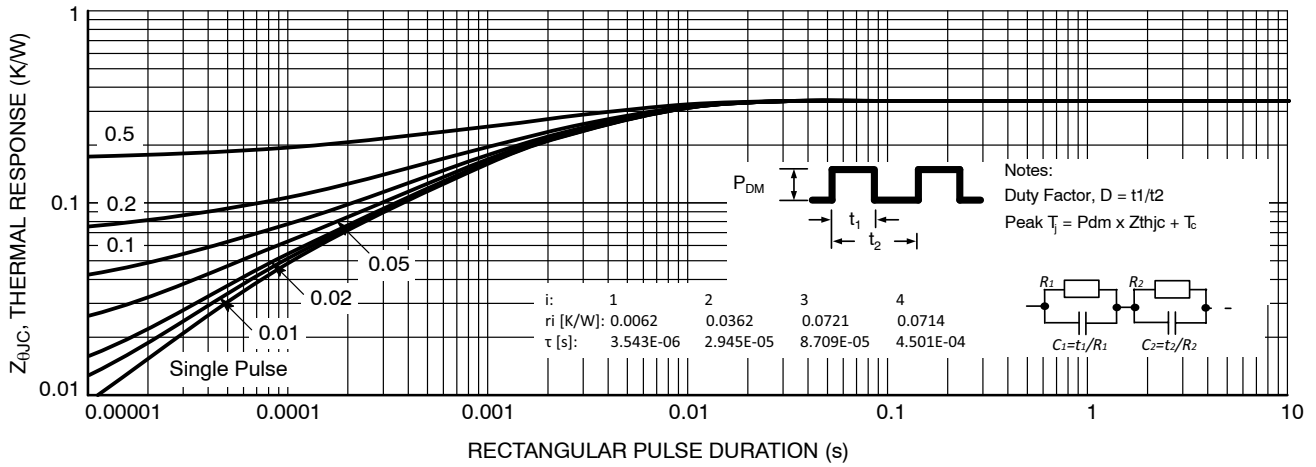

Figure 19. Transient Thermal Impedance of IGBT

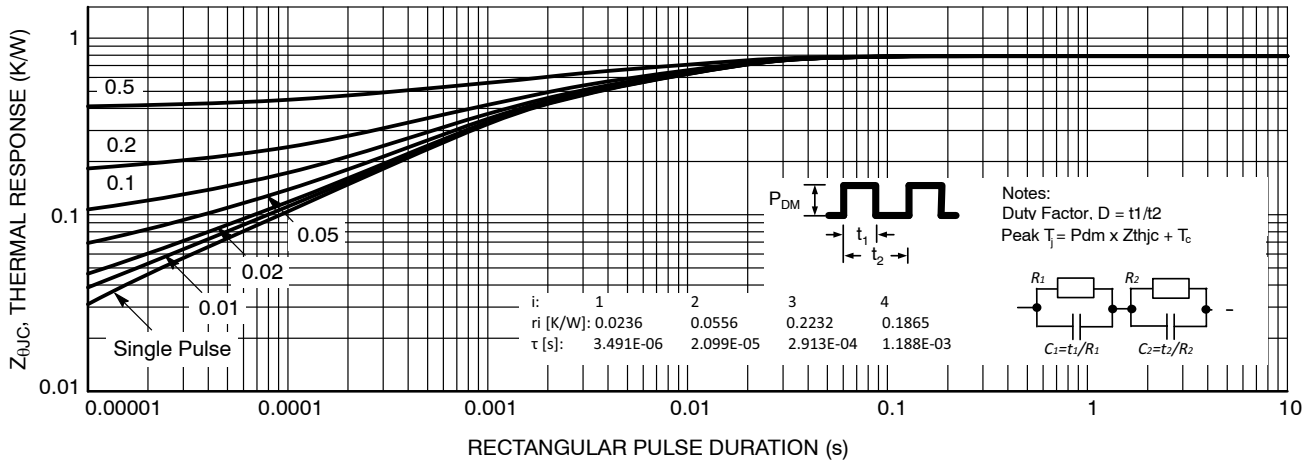
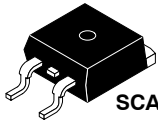

Figure 20. Transient Thermal Impedance of Diode



SCALE 1:1

D²PAK-3 (TO-263, 3-LEAD)
CASE 418AJ
ISSUE F

DATE 11 MAR 2021

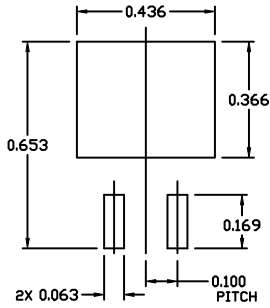

RECOMMENDED
MOUNTING FOOTPRINT

For additional information on our Pb-free strategy and soldering details, please download the IN Semiconductor Soldering and Mounting Techniques Reference Manual, SOLDERM/D.

NOTES:

- DIMENSIONING AND TOLERANCING PER ASME Y14.5M, 2009.
- CONTROLLING DIMENSION: INCHES
- CHAMFER OPTIONAL.
- DIMENSIONS D AND E DO NOT INCLUDE MOLD FLASH. MOLD FLASH SHALL NOT EXCEED 0.005 PER SIDE. THESE DIMENSIONS ARE MEASURED AT THE OUTERMOST EXTREMES OF THE PLASTIC BODY AT DATUM H.
- THERMAL PAD CONTOUR IS OPTIONAL WITHIN DIMENSIONS E, L1, D1, AND E1.
- OPTIONAL MOLD FEATURE.
- ①, ② ... OPTIONAL CONSTRUCTION FEATURE CALL OUTS.

DIM	INCHES		MILLIMETERS	
	MIN.	MAX.	MIN.	MAX.
A	0.160	0.190	4.06	4.83
A1	0.000	0.010	0.00	0.25
b	0.020	0.039	0.51	0.99
c	0.012	0.029	0.30	0.74
c2	0.045	0.065	1.14	1.65
D	0.330	0.380	8.38	9.65
D1	0.260	---	6.60	---
E	0.380	0.420	9.65	10.67
E1	0.245	---	6.22	---
e	0.100 BSC	---	2.54 BSC	---
H	0.575	0.625	14.60	15.88
L	0.070	0.110	1.78	2.79
L1	---	0.066	---	1.68
L2	---	0.070	---	1.78
L3	0.010 BSC	---	0.25 BSC	---
M	0°	8°	0°	8°

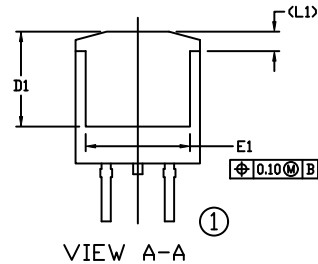
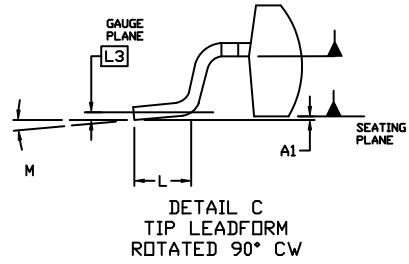
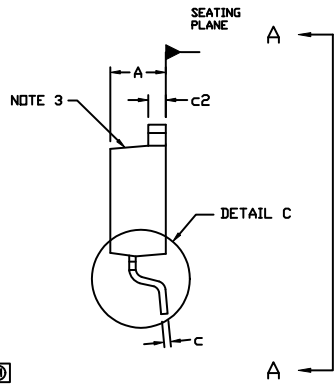
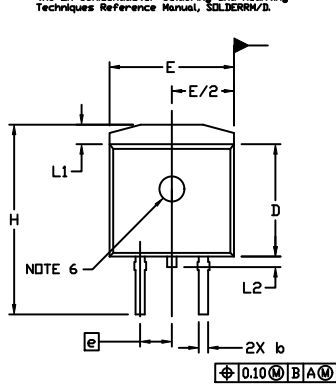

VIEW A-A

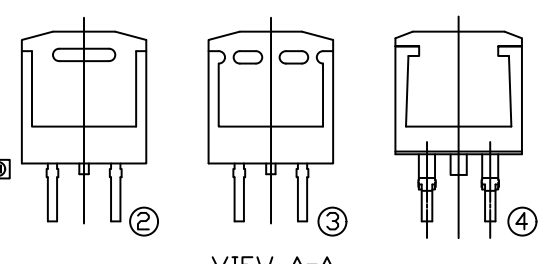

VIEW A-A
OPTIONAL CONSTRUCTIONS

GENERIC MARKING DIAGRAMS*

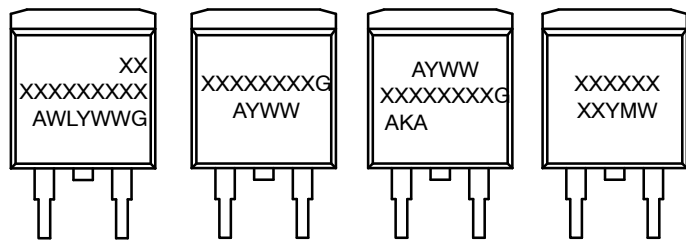

IC Standard Rectifier SSG

XXXXXX = Specific Device Code
 A = Assembly Location
 WL = Wafer Lot
 Y = Year
 WW = Work Week
 W = Week Code (SSG)
 M = Month Code (SSG)
 G = Pb-Free Package
 AKA = Polarity Indicator

*This information is generic. Please refer to device data sheet for actual part marking. Pb-Free indicator, "G" or microdot "▪", may or may not be present. Some products may not follow the Generic Marking.

DOCUMENT NUMBER:	98AON56370E	Electronic versions are uncontrolled except when accessed directly from the Document Repository. Printed versions are uncontrolled except when stamped "CONTROLLED COPY" in red.
DESCRIPTION:	D ² PAK-3 (TO-263, 3-LEAD)	PAGE 1 OF 1

onsemi and ONSEMI are trademarks of Semiconductor Components Industries, LLC dba onsemi or its subsidiaries in the United States and/or other countries. onsemi reserves the right to make changes without further notice to any products herein. onsemi makes no warranty, representation or guarantee regarding the suitability of its products for any particular purpose, nor does onsemi assume any liability arising out of the application or use of any product or circuit, and specifically disclaims any and all liability, including without limitation special, consequential or incidental damages. onsemi does not convey any license under its patent rights nor the rights of others.

onsemi, **Onsemi**, and other names, marks, and brands are registered and/or common law trademarks of Semiconductor Components Industries, LLC dba "**onsemi**" or its affiliates and/or subsidiaries in the United States and/or other countries. **onsemi** owns the rights to a number of patents, trademarks, copyrights, trade secrets, and other intellectual property. A listing of **onsemi**'s product/patent coverage may be accessed at www.onsemi.com/site/pdf/Patent-Marking.pdf. **onsemi** reserves the right to make changes at any time to any products or information herein, without notice. The information herein is provided "as-is" and **onsemi** makes no warranty, representation or guarantee regarding the accuracy of the information, product features, availability, functionality, or suitability of its products for any particular purpose, nor does **onsemi** assume any liability arising out of the application or use of any product or circuit, and specifically disclaims any and all liability, including without limitation special, consequential or incidental damages. Buyer is responsible for its products and applications using **onsemi** products, including compliance with all laws, regulations and safety requirements or standards, regardless of any support or applications information provided by **onsemi**. "Typical" parameters which may be provided in **onsemi** data sheets and/or specifications can and do vary in different applications and actual performance may vary over time. All operating parameters, including "Typicals" must be validated for each customer application by customer's technical experts. **onsemi** does not convey any license under any of its intellectual property rights nor the rights of others. **onsemi** products are not designed, intended, or authorized for use as a critical component in life support systems or any FDA Class 3 medical devices or medical devices with a same or similar classification in a foreign jurisdiction or any devices intended for implantation in the human body. Should Buyer purchase or use **onsemi** products for any such unintended or unauthorized application, Buyer shall indemnify and hold **onsemi** and its officers, employees, subsidiaries, affiliates, and distributors harmless against all claims, costs, damages, and expenses, and reasonable attorney fees arising out of, directly or indirectly, any claim of personal injury or death associated with such unintended or unauthorized use, even if such claim alleges that **onsemi** was negligent regarding the design or manufacture of the part. **onsemi** is an Equal Opportunity/Affirmative Action Employer. This literature is subject to all applicable copyright laws and is not for resale in any manner.

ADDITIONAL INFORMATION

TECHNICAL PUBLICATIONS:

Technical Library: www.onsemi.com/design/resources/technical-documentation
onsemi Website: www.onsemi.com

ONLINE SUPPORT: www.onsemi.com/support

For additional information, please contact your local Sales Representative at www.onsemi.com/support/sales

