

CM6305

EMI Filter with ESD Protection for SIM Card Applications

Product Description

The CM6305 is a 3 x 3, 8-bump EMI filter with ESD protection device for SIM card applications in a 0.4 mm pitch CSP form factor. It is fully compliant with IEC 61000-4-2. The CM6305 is also RoHS II compliant.



ON Semiconductor®

<http://onsemi.com>



WLCSP8
CASE 567CE

MARKING DIAGRAM

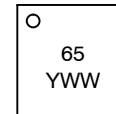

65 = CM6305
YWW = Date Code

ELECTRICAL SCHEMATIC

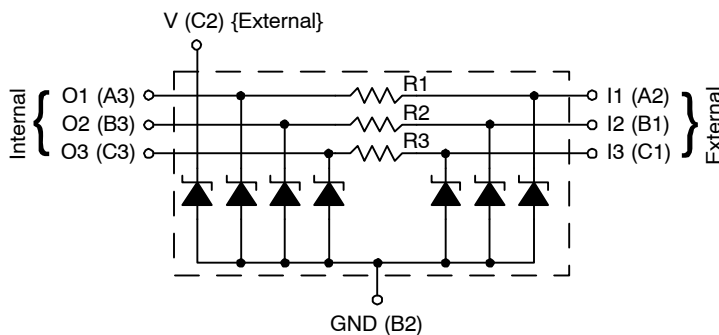

PACKAGE / PINOUT DIAGRAMS

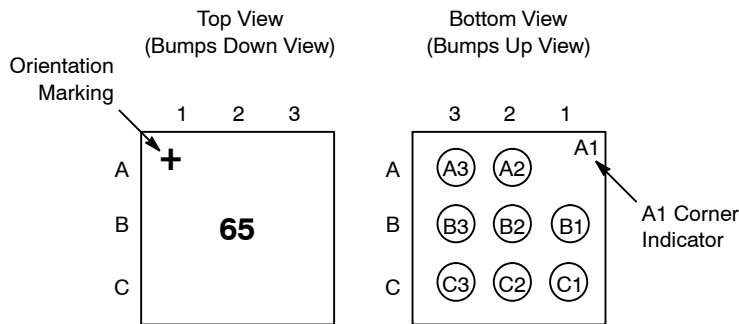

ORDERING INFORMATION

Device	Package	Shipping†
CM6305	WLCSP-8 (Pb-Free)	5000/Tape & Reel

†For information on tape and reel specifications, including part orientation and tape sizes, please refer to our Tape and Reel Packaging Specification Brochure, BRD8011/D.

Table 1. PIN DESCRIPTIONS

Pin	Description	Pin	Description
A2	Channel 1 External	A3	Channel 1 Internal
B1	Channel 2 External	B3	Channel 2 Internal
C1	Channel 3 External	C3	Channel 3 Internal
B2	GND	C2	V External

CM6305

ELECTRICAL SPECIFICATIONS AND CONDITIONS

Table 2. PARAMETERS AND OPERATING CONDITIONS

Parameter	Rating	Units
Storage Temperature Range	-55 to +150	°C
Operating Temperature Range	-40 to +85	°C
Power Dissipation at 70°C per Channel	60	mW

Table 3. ELECTRICAL OPERATING CHARACTERISTICS (Note 1)

Symbol	Parameter	Conditions	Min	Typ	Max	Units
R ₁	Resistance		80	100	120	Ω
R ₂	Resistance		37.6	47	56.4	Ω
R ₃	Resistance		80	100	120	Ω
I _{LEAK}	Leakage Current per Channel	V _{IN} = 3.0 V		10	100	nA
C	Capacitance on Filter Channels 1, 2 and 3	At 1 MHz, V _{IN} = 0 V	8	10	12	pF
	Capacitance on Clamp Channel (pin C2)	At 1 MHz, V _{IN} = 0 V	8	10	12	pF
V _B	Breakdown Voltage (Positive)	I _R = 1 mA	6	7	9	V
V _{ESD}	ESD Protection Peak Discharge Voltage at A2, B1 and C1 pins a) Contact Discharge per IEC 61000-4-2 standard b) Air Discharge per IEC 61000-4-2 standard	(Note 2)	±8 ±15			kV
	ESD Protection Peak Discharge Voltage at C2 pin a) Contact Discharge per IEC 61000-4-2 standard b) Air Discharge per IEC 61000-4-2 standard	(Note 2)	±15 ±15			kV
	ESD Protection Peak Discharge Voltage at A3, B3 and C3 pins a) Contact Discharge per IEC 61000-4-2 standard b) Air Discharge per IEC 61000-4-2 standard	(Note 2)	±2 ±2			kV

1. All parameters specified at T_A = 25°C unless otherwise noted.
2. Standard IEC 61000-4-2 with C_{Discharge} = 150 pF, R_{Discharge} = 330 Ω.

Table 4. CSP TAPE AND REEL SPECIFICATIONS †

Part Number	Chip Size (mm)	Pocket Size (mm) B ₀ X A ₀ X K ₀	Tape Width W	Reel Dia.	Qty Per Reel	P ₀	P ₁
CM6305	1.16 X 1.16 X 0.60	1.27 X 1.27 X 0.69	8 mm	178 mm (7")	5000	4 mm	4 mm

†For information on tape and reel specifications, including part orientation and tape sizes, please refer to our Tape and Reel Packaging Specification Brochure, BRD8011/D.

CM6305

RF CHARACTERISTICS

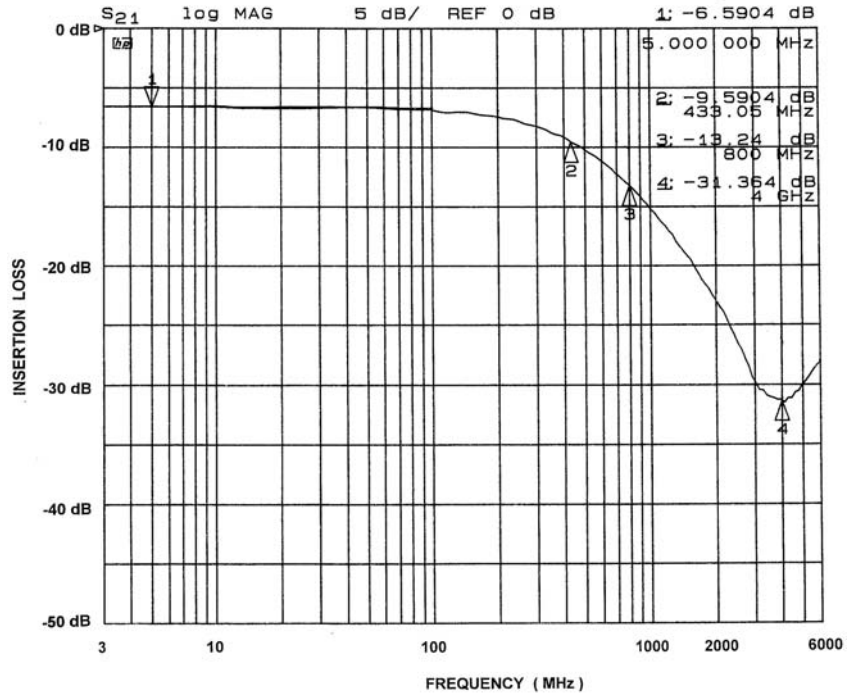

Figure 1. Insertion Loss, Filter 1 (pins A2, A3) and Filter 3 (pins C1, C3) (Bias = 0 V, $T_A = 25^\circ\text{C}$)

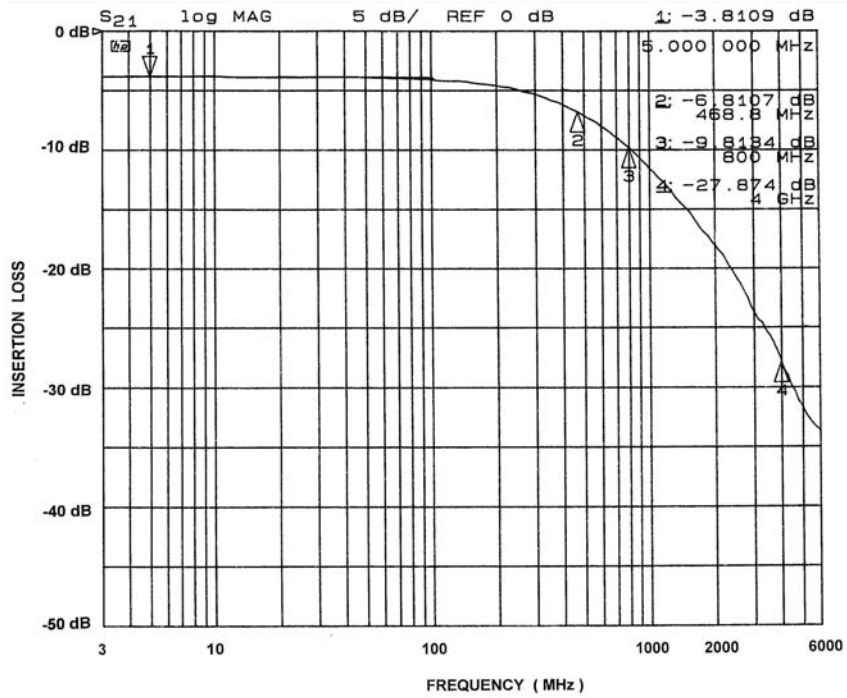

Figure 2. Insertion Loss, Filter 2 (pins B1, B3) (Bias = 0 V, $T_A = 25^\circ\text{C}$)

MECHANICAL CASE OUTLINE PACKAGE DIMENSIONS

ON Semiconductor®



SCALE 4:1

WLCSP8, 1.16x1.16
CASE 567CE-01
ISSUE O

DATE 27 JUL 2010

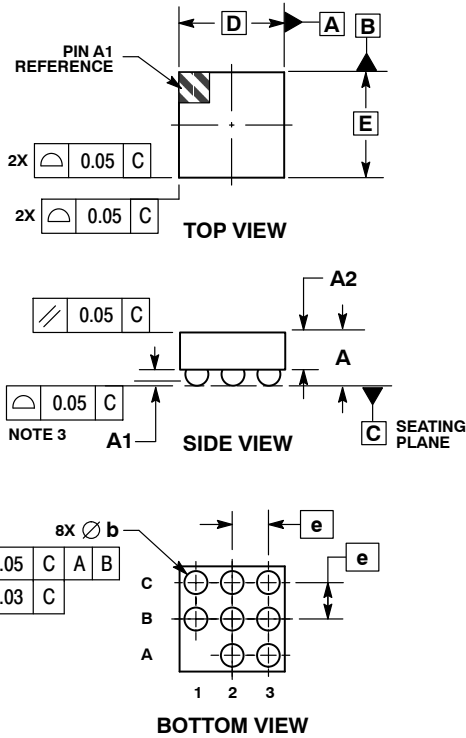

NOTES:

1. DIMENSIONING AND TOLERANCING PER ASME Y14.5M, 1994.
2. CONTROLLING DIMENSION: MILLIMETERS.
3. COPLANARITY APPLIES TO SPHERICAL CROWNS OF SOLDER BALLS.

DIM	MILLIMETERS	
	MIN	MAX
A	0.57	0.63
A1	0.17	0.24
A2	0.41 REF	
b	0.24	0.29
D	1.16 BSC	
E	1.16 BSC	
e	0.40 BSC	

**RECOMMENDED
SOLDERING FOOTPRINT***

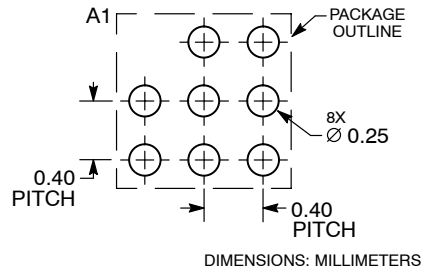

*For additional information on our Pb-Free strategy and soldering details, please download the ON Semiconductor Soldering and Mounting Techniques Reference Manual, SOLDERRM/D.

DOCUMENT NUMBER:	98AON50308E	Electronic versions are uncontrolled except when accessed directly from the Document Repository. Printed versions are uncontrolled except when stamped "CONTROLLED COPY" in red.
DESCRIPTION:	WLCSP8, 1.16X1.16	PAGE 1 OF 1

ON Semiconductor and are trademarks of Semiconductor Components Industries, LLC dba ON Semiconductor or its subsidiaries in the United States and/or other countries. ON Semiconductor reserves the right to make changes without further notice to any products herein. ON Semiconductor makes no warranty, representation or guarantee regarding the suitability of its products for any particular purpose, nor does ON Semiconductor assume any liability arising out of the application or use of any product or circuit, and specifically disclaims any and all liability, including without limitation special, consequential or incidental damages. ON Semiconductor does not convey any license under its patent rights nor the rights of others.

onsemi, **Onsemi**, and other names, marks, and brands are registered and/or common law trademarks of Semiconductor Components Industries, LLC dba "**onsemi**" or its affiliates and/or subsidiaries in the United States and/or other countries. **onsemi** owns the rights to a number of patents, trademarks, copyrights, trade secrets, and other intellectual property. A listing of **onsemi**'s product/patent coverage may be accessed at www.onsemi.com/site/pdf/Patent-Marking.pdf. **onsemi** reserves the right to make changes at any time to any products or information herein, without notice. The information herein is provided "as-is" and **onsemi** makes no warranty, representation or guarantee regarding the accuracy of the information, product features, availability, functionality, or suitability of its products for any particular purpose, nor does **onsemi** assume any liability arising out of the application or use of any product or circuit, and specifically disclaims any and all liability, including without limitation special, consequential or incidental damages. Buyer is responsible for its products and applications using **onsemi** products, including compliance with all laws, regulations and safety requirements or standards, regardless of any support or applications information provided by **onsemi**. "Typical" parameters which may be provided in **onsemi** data sheets and/or specifications can and do vary in different applications and actual performance may vary over time. All operating parameters, including "Typicals" must be validated for each customer application by customer's technical experts. **onsemi** does not convey any license under any of its intellectual property rights nor the rights of others. **onsemi** products are not designed, intended, or authorized for use as a critical component in life support systems or any FDA Class 3 medical devices or medical devices with a same or similar classification in a foreign jurisdiction or any devices intended for implantation in the human body. Should Buyer purchase or use **onsemi** products for any such unintended or unauthorized application, Buyer shall indemnify and hold **onsemi** and its officers, employees, subsidiaries, affiliates, and distributors harmless against all claims, costs, damages, and expenses, and reasonable attorney fees arising out of, directly or indirectly, any claim of personal injury or death associated with such unintended or unauthorized use, even if such claim alleges that **onsemi** was negligent regarding the design or manufacture of the part. **onsemi** is an Equal Opportunity/Affirmative Action Employer. This literature is subject to all applicable copyright laws and is not for resale in any manner.

ADDITIONAL INFORMATION

TECHNICAL PUBLICATIONS:

Technical Library: www.onsemi.com/design/resources/technical-documentation
onsemi Website: www.onsemi.com

ONLINE SUPPORT: www.onsemi.com/support

For additional information, please contact your local Sales Representative at www.onsemi.com/support/sales