

# H-Bridge in APM16 Series for LLC and Phase-shifted DC-DC Converter

## FAM65HR51XS1, FAM65HR51XS2

### Features

- SIP or DIP H-Bridge Power Module for On-board Charger (OBC) in EV or PHEV
- 5 kV/1 sec Electrically Isolated Substrate for Easy Assembly
- Creepage and Clearance per IEC60664-1, IEC 60950-1
- Compact Design for Low Total Module Resistance
- Module Serialization for Full Traceability
- Lead Free, RoHS and UL94V-0 Compliant
- Automotive Qualified per AEC Q101 and AQC324 Guidelines

### Applications

- DC-DC Converter for On-board Charger in EV or PHEV

### Benefits

- Enable Design of Small, Efficient and Reliable System for Reduced Vehicle Fuel Consumption and CO<sub>2</sub> Emission
- Simplified Assembly, Optimized Layout, High Level of Integration, and Improved Thermal Performance

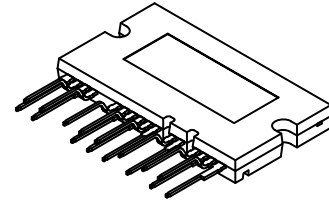

APMCA-A16  
 16 LEAD  
 CASE MODGF

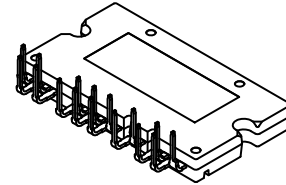

APMCA-B16  
 16 LEAD  
 CASE MODGJ

### MARKING DIAGRAM

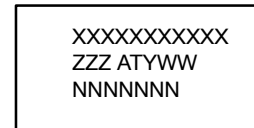

XXXX = Specific Device Code  
 ZZZ = Lot ID  
 AT = Assembly & Test Location  
 Y = Year  
 W = Work Week  
 NNN = Serial Number

### ORDERING INFORMATION

See detailed ordering, marking and shipping information on page 2 of this data sheet.

# FAM65HR51XS1, FAM65HR51XS2

## ORDERING INFORMATION

Part Number	Package	Lead Forming	Snubber Capacitor Inside	DBC Material	Pb-Free and RoHS Compliant	Operating Temperature (T <sub>A</sub> )	Packing Method
FAM65HR51XS1	APM16-CAA	Y-Shape	Yes	ALN	Yes	-40°C ~ 125°C	Tube
FAM65HR51XS2	APM16-CAB	L-Shape	Yes	ALN	Yes	-40°C ~ 125°C	Tube

## Pin Configuration and Description

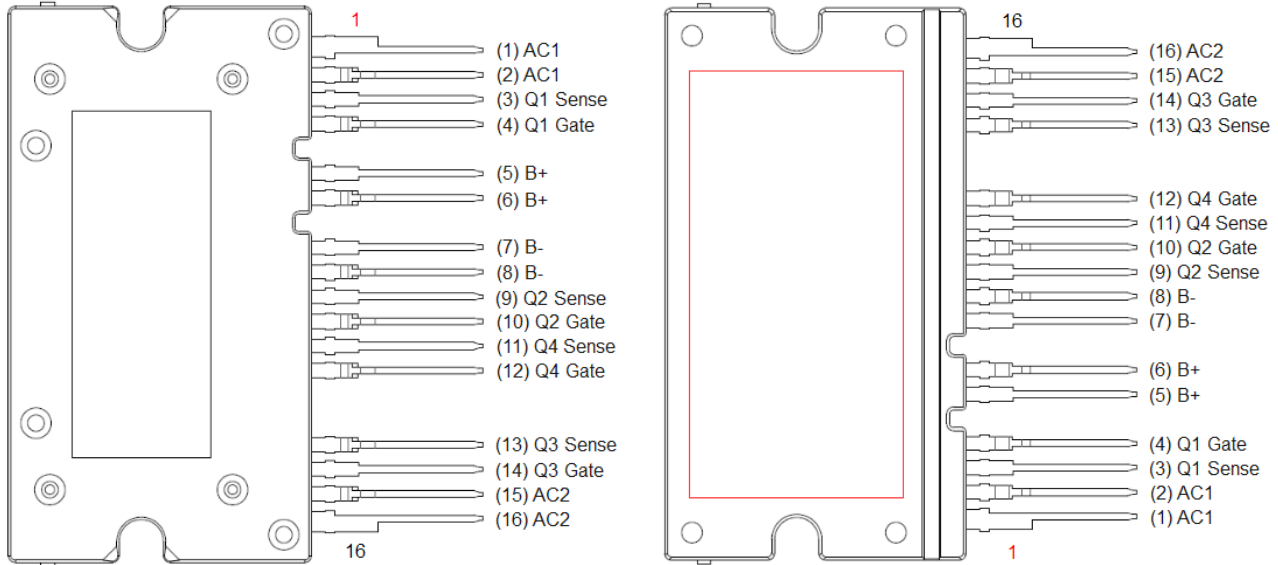

Figure 1. Pin Configuration

Table 1. PIN DESCRIPTION

Pin Number	Pin Name	Pin Description
1, 2	AC1	Phase 1 Leg of the H-Bridge
3	Q1 Sense	Source Sense of Q1
4	Q1 Gate	Gate Terminal of Q1
5, 6	B+	Positive Battery Terminal
7, 8	B-	Negative Battery Terminal
9	Q2 Sense	Source Sense of Q2
10	Q2 Gate	Gate Terminal of Q2
11	Q4 Sense	Source Sense of Q4
12	Q4 Gate	Gate Terminal of Q4
13	Q3 Sense	Source Sense of Q3
14	Q3 Gate	Gate Terminal of Q3
15, 16	AC2	Phase 2 Leg of the H-Bridge

# FAM65HR51XS1, FAM65HR51XS2

## INTERNAL EQUIVALENT CIRCUIT

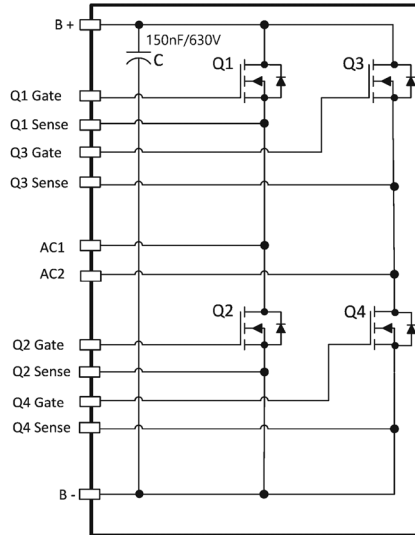

Figure 2. Internal Block Diagram

Table 2. ABSOLUTE MAXIMUM RATINGS ( $T_J = 25^\circ\text{C}$ , Unless Otherwise Specified)

Symbol	Parameter	Max	Unit
$V_{DS}$ (Q1~Q4)	Drain-to-Source Voltage	650	V
$V_{GS}$ (Q1~Q4)	Gate-to-Source Voltage	$\pm 20$	V
$I_D$ (Q1~Q4)	Drain Current Continuous ( $T_C = 25^\circ\text{C}$ , $V_{GS} = 10\text{ V}$ ) (Note 1)	64	A
	Drain Current Continuous ( $T_C = 100^\circ\text{C}$ , $V_{GS} = 10\text{ V}$ ) (Note 1)	40	A
$E_{AS}$ (Q1~Q4)	Single Pulse Avalanche Energy (Note 2)	623	mJ
$E_{AS}$ (Q1~Q4)	Single Pulse Avalanche Energy (Note 2)	21	mJ
$I_{AS}$	Avalanche Current	6.5	A
$P_D$	Power Dissipation (Note 1)	463	W
$T_J$	Maximum Junction Temperature	-55 to +150	$^\circ\text{C}$
$T_C$	Maximum Case Temperature	-40 to +125	$^\circ\text{C}$
$T_{STG}$	Storage Temperature	-40 to +125	$^\circ\text{C}$

Stresses exceeding those listed in the Maximum Ratings table may damage the device. If any of these limits are exceeded, device functionality should not be assumed, damage may occur and reliability may be affected.

1. Maximum continuous current and power, without switching losses, to reach  $T_J = 150^\circ\text{C}$  respectively at  $T_C = 25^\circ\text{C}$  and  $T_C = 100^\circ\text{C}$ ; defined by design based on MOSFET  $R_{DS(ON)}$  and  $R_{\theta JC}$  and not subject to production test
2. 623 mJ is characterized at  $T_J = 25^\circ\text{C}$ ,  $L = 29.5\text{ mH}$ ,  $I_{AS} = 6.5\text{ A}$ ,  $V_{DD} = 145\text{ V}$ .  
21 mJ is 100% tested at  $L = 1\text{ mH}$ ,  $I_{AS} = 6.5\text{ A}$ .

Table 3. COMPONENTS (Note 3)

Device	Parameter	Condition	Min	Typ	Max	Unit
Capacitor (Snubber) AEC Q200 qualified	Capacitance	$T_J = 25^\circ\text{C}$	135	150	165	nF
	Rated Voltage		-	630	-	V

3. These values are obtained from the specification provided by the manufacturer.

### DBC Substrate

0.63 mm ALN alumina with 0.3 mm copper on both sides.  
DBC substrate is NOT nickel plated.

### Lead Frame

OFC copper alloy, 0.50 mm thick. Plated with 8  $\mu\text{m}$  to 25.4  $\mu\text{m}$  thick Matte Tin

### Flammability Information

All materials present in the power module meet UL flammability rating class 94V-0.

### Compliance to RoHS Directives

The power module is 100% lead free and RoHS compliant 2000/53/C directive.

### Solder

Solder used is a lead free SnAgCu alloy.

## FAM65HR51XS1, FAM65HR51XS2

Solder presents high risk to melt at temperature beyond 210°C. Base of the leads, at the interface with the package body, should not be exposed to more than 200°C during

mounting on the PCB or during welding to prevent the re-melting of the solder joints.

**Table 4. ELECTRICAL SPECIFICATIONS** ( $T_J = 25^\circ\text{C}$ , Unless Otherwise Specified)

Symbol	Parameter	Conditions	Min	Typ	Max	Unit
$BV_{DSS}$	Drain-to-Source Breakdown Voltage	$I_D = 1 \text{ mA}, V_{GS} = 0 \text{ V}$	650	–	–	V
$V_{GS(th)}$	Gate to Source Threshold Voltage	$V_{GS} = V_{DS}, I_D = 3.3 \text{ mA}$	3.0	–	5.0	V
$R_{DS(ON)}$	Q1 – Q4 MOSFET On Resistance	$V_{GS} = 10 \text{ V}, I_D = 20 \text{ A}$	–	44	51	m $\Omega$
$R_{DS(ON)}$	Q1 – Q4 MOSFET On Resistance	$V_{GS} = 10 \text{ V}, I_D = 20 \text{ A}, T_J = 125^\circ\text{C}$ (Note 4)	–	79	–	m $\Omega$
$g_{FS}$	Forward Transconductance	$V_{DS} = 20 \text{ V}, I_D = 20 \text{ A}$ (Note 4)	–	30	–	S
$I_{GSS}$	Gate-to-Source Leakage Current	$V_{GS} = \pm 20 \text{ V}, V_{DS} = 0 \text{ V}$	–100	–	+100	nA
$I_{DSS}$	Drain-to-Source Leakage Current	$V_{DS} = 650 \text{ V}, V_{GS} = 0 \text{ V}$	–	–	10	$\mu\text{A}$

### DYNAMIC CHARACTERISTICS (Note 4)

$C_{iss}$	Input Capacitance	$V_{DS} = 400 \text{ V}$ $V_{GS} = 0 \text{ V}$ $f = 1 \text{ MHz}$	–	4864	–	pF
$C_{oss}$	Output Capacitance		–	109	–	pF
$C_{rss}$	Reverse Transfer Capacitance		–	16	–	pF
$C_{oss(eff)}$	Effective Output Capacitance	$V_{DS} = 0 \text{ to } 520 \text{ V}, V_{GS} = 0 \text{ V}$	–	652	–	pF
$R_g$	Gate Resistance	$f = 1 \text{ MHz}$	–	2	–	$\Omega$
$Q_{g(tot)}$	Total Gate Charge	$V_{DS} = 380 \text{ V}$ $I_D = 20 \text{ A}$ $V_{GS} = 0 \text{ to } 10 \text{ V}$	–	123	–	nC
$Q_{gs}$	Gate-to-Source Gate Charge		–	37.5	–	nC
$Q_{gd}$	Gate-to-Drain "Miller" Charge		–	49	–	nC

### SWITCHING CHARACTERISTICS (Note 4)

$t_{on}$	Turn-on Time	$V_{DS} = 400 \text{ V}$ $I_D = 20 \text{ A}$ $V_{GS} = 10 \text{ V}$ $R_G = 4.7 \text{ }\Omega$	–	87	–	ns
$t_{d(on)}$	Turn-on Delay Time		–	47	–	ns
$t_r$	Turn-on Rise Time		–	43	–	ns
$t_{off}$	Turn-off Time		–	148	–	ns
$t_{d(off)}$	Turn-off Delay Time		–	118	–	ns
$t_f$	Turn-off Fall Time		–	29	–	ns

### BODY DIODE CHARACTERISTICS

$V_{SD}$	Source-to-Drain Diode Voltage	$I_{SD} = 20 \text{ A}, V_{GS} = 0 \text{ V}$	–	0.95	–	V
$T_{rr}$	Reverse Recovery Time	$V_{DS} = 520 \text{ V}, I_D = 20 \text{ A},$ $dI/dt = 100 \text{ A}/\mu\text{s}$ (Note 4)	–	133	–	ns
$Q_{rr}$	Reverse Recovery Charge		–	669	–	nC

Product parametric performance is indicated in the Electrical Characteristics for the listed test conditions, unless otherwise noted. Product performance may not be indicated by the Electrical Characteristics if operated under different conditions.

4. Defined by design, not subject to production test

**Table 5. THERMAL RESISTANCE**

Parameters		Min	Typ	Max	Unit
$R_{\theta JC}$ (per chip)	Q1–Q4 Thermal Resistance Junction-to-Case (Note 5)	–	0.19	0.27	$^\circ\text{C}/\text{W}$
$R_{\theta JS}$ (per chip)	Q1–Q4 Thermal Resistance Junction-to-Sink (Note 6)	–	0.75	–	$^\circ\text{C}/\text{W}$

5. Test method compliant with MIL STD 883–1012.1, from case temperature under the chip to case temperature measured below the package at the chip center, Cosmetic oxidation and discoloration on the DBC surface allowed

6. Defined by thermal simulation assuming the module is mounted on a 5 mm Al–360 die casting material with 30  $\mu\text{m}$  of 1.8 W/mK thermal interface material

**Table 6. ISOLATION** (Isolation resistance at tested voltage from the base plate to control pins or power terminals.)

Test	Test Conditions	Isolation Resistance	Unit
Leakage @ Isolation Voltage (Hi–Pot)	$V_{AC} = 5 \text{ kV}, 50 \text{ Hz}$	100M <	$\Omega$

# FAM65HR51XS1, FAM65HR51XS2

## PARAMETER DEFINITIONS

Reference to Table 4: Parameter of Electrical Specifications

$BV_{DSS}$	<p>Q1 – Q4 MOSFET Drain-to-Source Breakdown Voltage</p> <p>The maximum drain-to-source voltage the MOSFET can endure without the avalanche breakdown of the body- drain P-N junction in off state.</p> <p>The measurement conditions are to be found in Table 4.</p> <p>The typ. Temperature behavior is described in Figure 13</p>
$V_{GS(th)}$	<p>Q1 – Q4 MOSFET Gate to Source Threshold Voltage</p> <p>The gate-to-source voltage measurement is triggered by a threshold ID current given in conditions at Table 3.</p> <p>The typ. Temperature behavior can be found in Figure 12</p>
$R_{DS(on)}$	<p>Q1 – Q4 MOSFET On Resistance</p> <p><math>R_{DS(on)}</math> is the total resistance between the source and the drain during the on state.</p> <p>The measurement conditions are to be found in Table 4.</p> <p>The typ behavior can be found in Figure 10 and Figure 11 as well as Figure 17</p>
$g_{fs}$	<p>Q1 – Q4 MOSFET Forward Transconductance</p> <p>Transconductance is the gain in the MOSFET, expressed in the Equation below.</p> <p>It describes the change in drain current by the change in the gate-source bias voltage: <math>g_{fs} = [ \Delta I_{DS} / \Delta V_{GS} ]_{V_{DS}}</math></p>
$I_{GSS}$	<p>Q1 – Q4 MOSFET Gate-to-Source Leakage Current</p> <p>The current flowing from Gate to Source at the maximum allowed VGS</p> <p>The measurement conditions are described in the Table 4.</p>
$I_{DSS}$	<p>Q1 – Q4 MOSFET Drain-to-Source Leakage Current</p> <p>Drain – Source current is measured in off state while providing the maximum allowed drain-to-source voltage and the gate is shorted to the source.</p> <p>IDSS has a positive temperature coefficient.</p>

## FAM65HR51XS1, FAM65HR51XS2

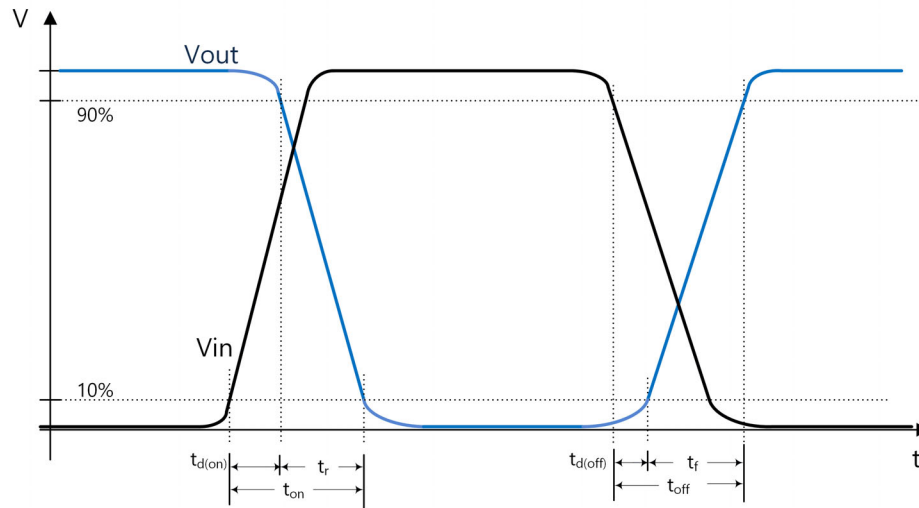

**Figure 3. Timing Measurement Variable Definition**

**Table 7. PARAMETER OF SWITCHING CHARACTERISTICS**

Turn-On Delay ( $t_{d(on)}$ )	This is the time needed to charge the input capacitance, $C_{iss}$ , before the load current $I_D$ starts flowing. The measurement conditions are described in the Table 4. For signal definition please check Figure 3 above.
Rise Time ( $t_r$ )	The rise time is the time to discharge output capacitance, $C_{oss}$ . After that time the MOSFET conducts the given load current $I_D$ . The measurement conditions are described in the Table 4. For signal definition please check Figure 3 above.
Turn-On Time ( $t_{on}$ )	Is the sum of turn-on-delay and rise time
Turn-Off Delay ( $t_{d(off)}$ )	$t_{d(off)}$ is the time to discharge $C_{iss}$ after the MOSFET is turned off. During this time the load current $I_D$ is still flowing. The measurement conditions are described in the Table 4. For signal definition please check Figure 3 above.
Fall Time ( $t_f$ )	The fall time, $t_f$ , is the time to charge the output capacitance, $C_{oss}$ . During this time the load current drops down and the voltage $V_{DS}$ rises accordingly. The measurement conditions are described in the Table 4. For signal definition please check Figure 3 above.
Turn-Off Time ( $t_{off}$ )	Is the sum of turn-off-delay and fall time

# FAM65HR51XS1, FAM65HR51XS2

## TYPICAL CHARACTERISTICS

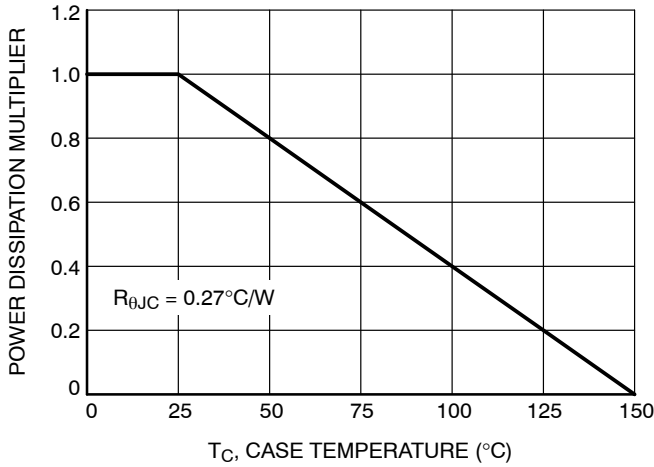

**Figure 4. Normalized Power Dissipation vs. Case**

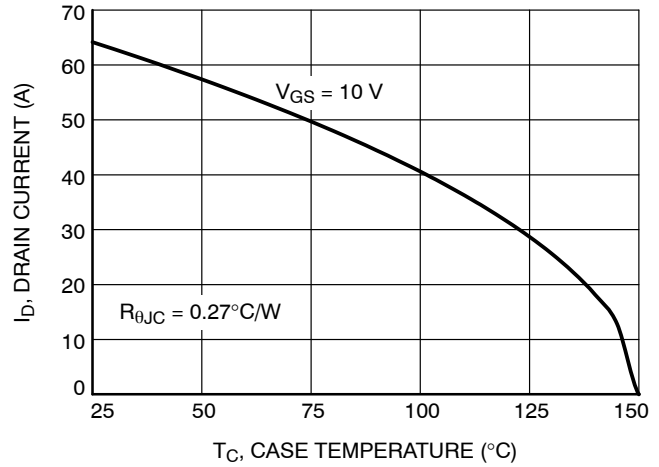

**Figure 5. Maximum Continuous  $I_D$  vs. Case Temperature**

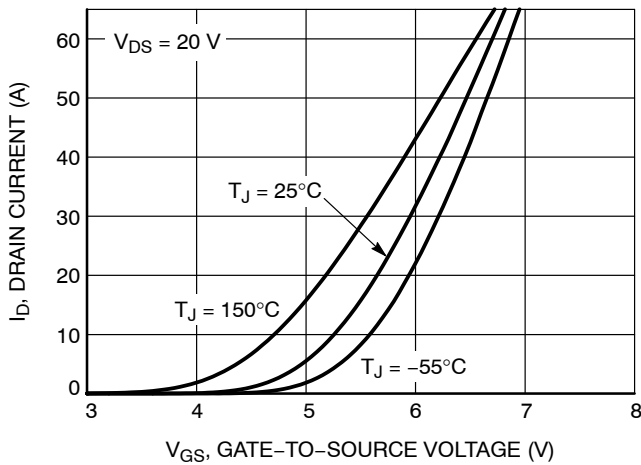

**Figure 6. Transfer Characteristics**

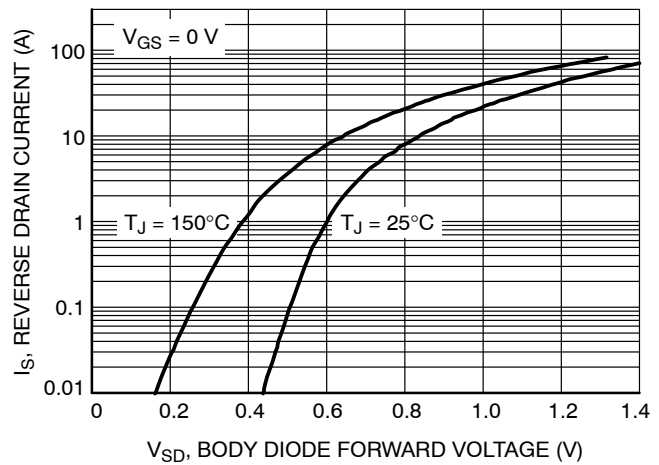

**Figure 7. Forward Diode**

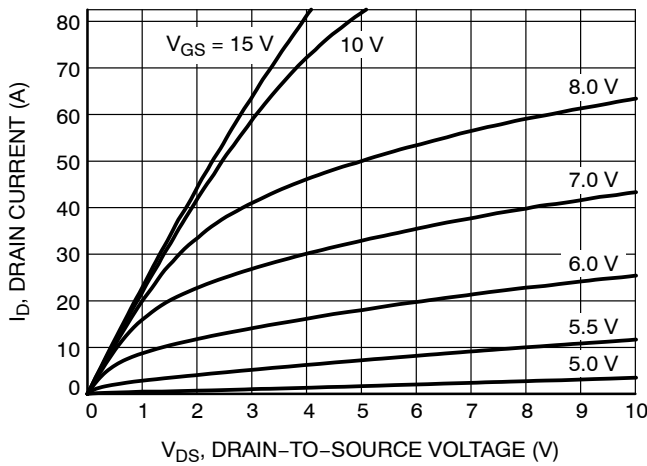

**Figure 8. On Region Characteristics ( $25^{\circ}\text{C}$ )**

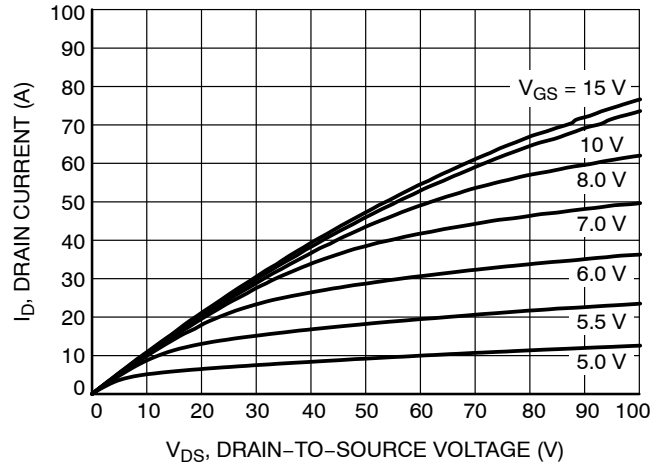

**Figure 9. On Region Characteristics ( $150^{\circ}\text{C}$ )**

# FAM65HR51XS1, FAM65HR51XS2

## TYPICAL CHARACTERISTICS

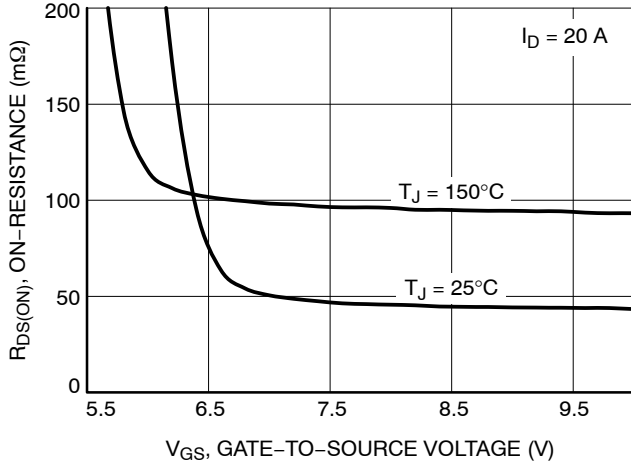

**Figure 10. On-Resistance vs. Gate-to-Source Voltage**

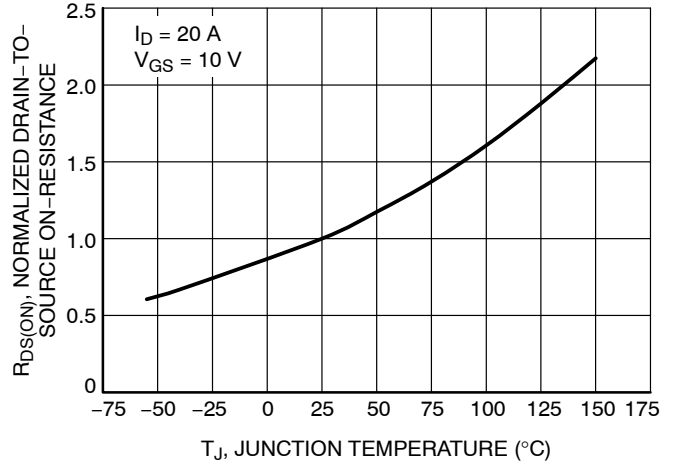

**Figure 11.  $R_{DS(norm)}$  vs. Junction Temperature**

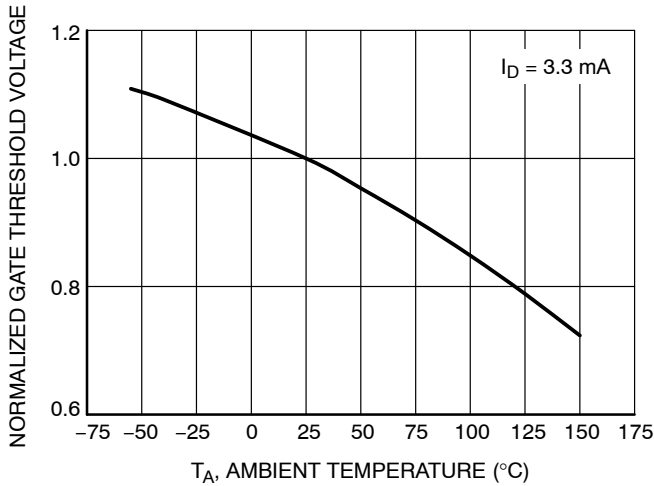

**Figure 12. Normalized Gate Threshold Voltage vs. Temperature**

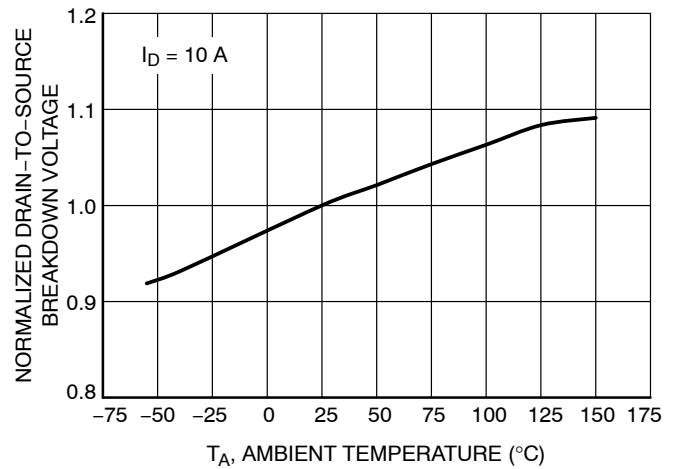

**Figure 13. Normalized Breakdown Voltage vs. Temperature**

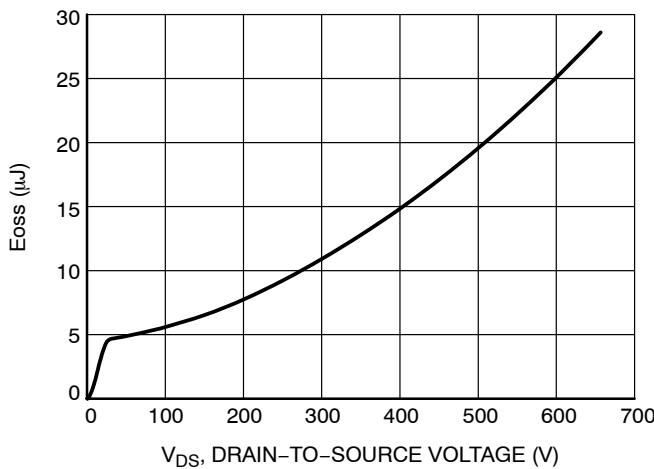

**Figure 14.  $E_{oss}$  vs. Drain-to-Source Voltage**

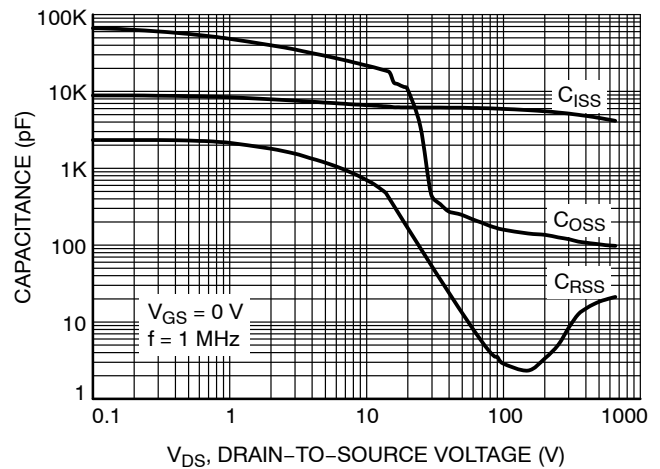

**Figure 15. Capacitance Variation**



TYPICAL CHARACTERISTICS

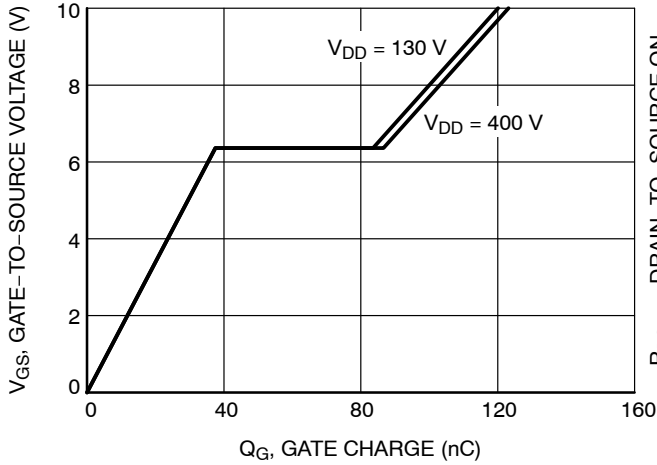

Figure 16. Gate Charge Characteristics

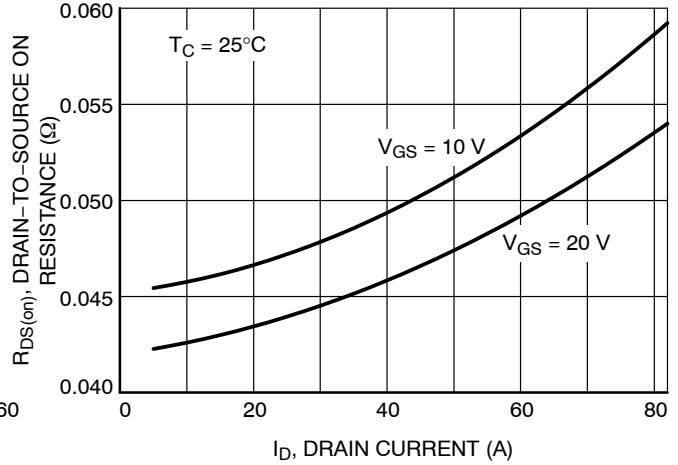

Figure 17. ON-Resistance Variation with Drain Current and Gate Voltage

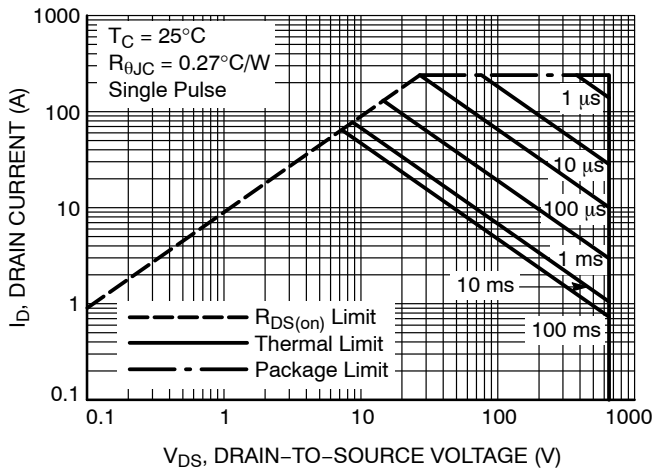

Figure 18. Safe Operating Area

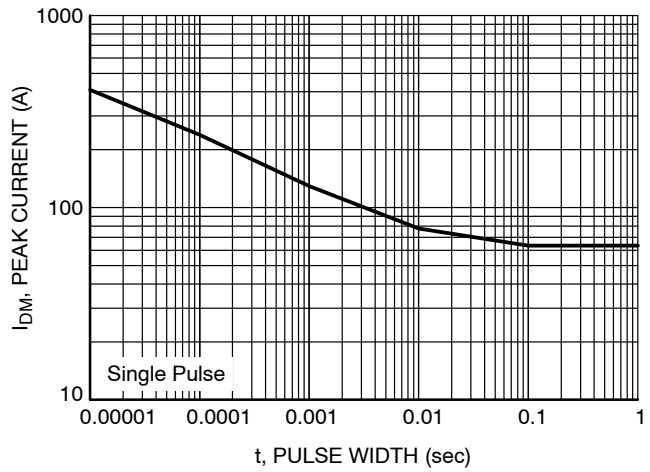

Figure 19. Peak Current Capability

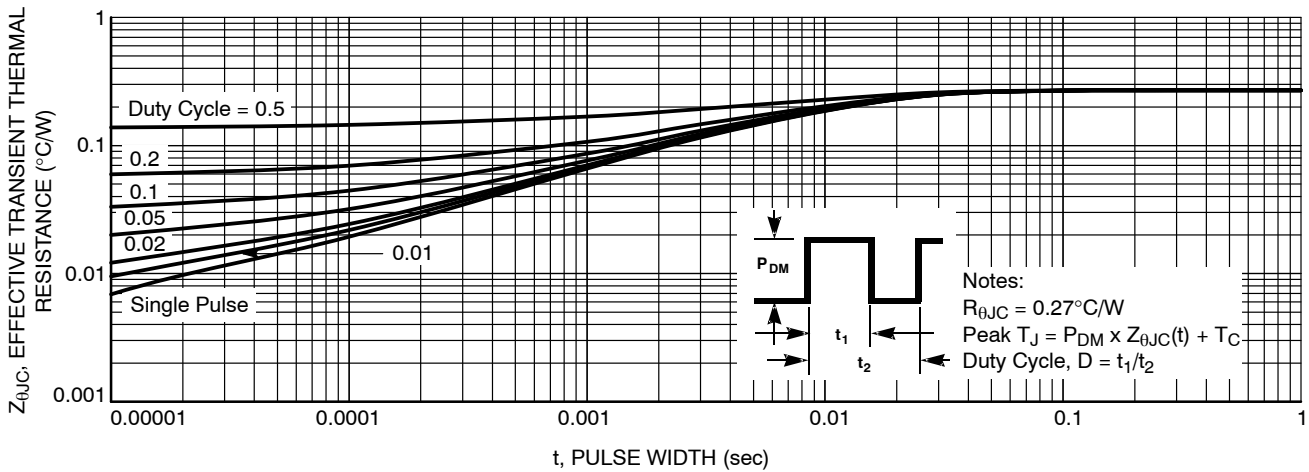
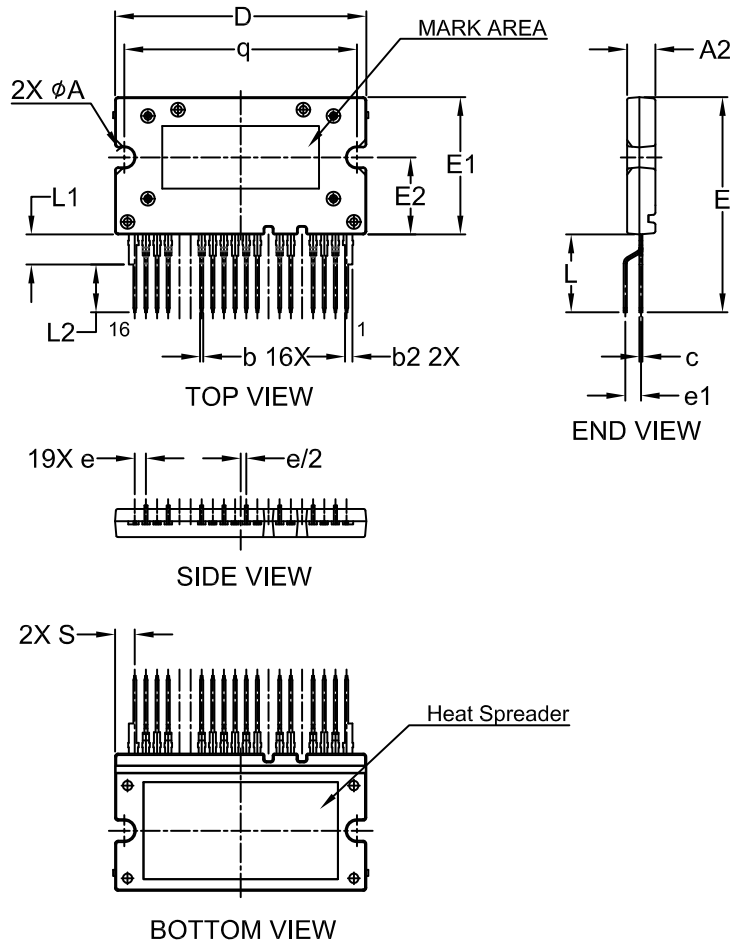
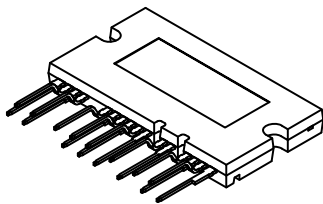

Figure 20. Transient Thermal Impedance

**APMCA-A16 / 16LD, AUTOMOTIVE MODULE**  
CASE MODGF  
ISSUE C

DATE 03 NOV 2021



NOTES:

1. DIMENSIONING AND TOLERANCING PER. ASME Y14.5M, 2009.
2. CONTROLLING DIMENSION: MILLIMETERS
3. DIMENSIONS ARE EXCLUSIVE OF BURRS, MOLD FLASH AND TIE BAR EXTRUSIONS.

DIM	MILLIMETERS		
	MIN.	NOM.	MAX.
A2	4.30	4.50	4.70
b	0.45	0.50	0.60
b2	1.15	1.20	1.30
c	0.45	0.50	0.60
D	39.90	40.10	40.30
E	33.80	34.30	34.80
E1	21.70	21.90	22.10
E2	12.10	12.30	12.50
e	1.478	1.778	2.078
e1	2.20	2.50	2.80
L	12.10	12.40	12.70
L1	4.80 REF		
L2	7.30	7.60	7.90
q	36.85	37.10	37.35
S	3.159 REF		
φA	3.00	3.20	3.40

**GENERIC MARKING DIAGRAM\***

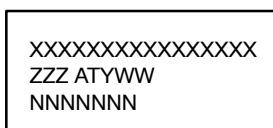

XXXX = Specific Device Code  
 ZZZ = Lot ID  
 AT = Assembly & Test Location  
 Y = Year  
 W = Work Week  
 NNN = Serial Number

\*This information is generic. Please refer to device data sheet for actual part marking. Pb-Free indicator, "G" or microdot "μ", may or may not be present. Some products may not follow the Generic Marking.

<b>DOCUMENT NUMBER:</b>	<b>98AON94732G</b>	Electronic versions are uncontrolled except when accessed directly from the Document Repository. Printed versions are uncontrolled except when stamped "CONTROLLED COPY" in red.
<b>DESCRIPTION:</b>	<b>APMCA-A16 / 16LD, AUTOMOTIVE MODULE</b>	<b>PAGE 1 OF 1</b>

onsemi and Onsemi are trademarks of Semiconductor Components Industries, LLC dba onsemi or its subsidiaries in the United States and/or other countries. onsemi reserves the right to make changes without further notice to any products herein. onsemi makes no warranty, representation or guarantee regarding the suitability of its products for any particular purpose, nor does onsemi assume any liability arising out of the application or use of any product or circuit, and specifically disclaims any and all liability, including without limitation special, consequential or incidental damages. onsemi does not convey any license under its patent rights nor the rights of others.

**PIM16 40.10x21.90x4.50  
CASE MODGJ  
ISSUE D**

DATE 17 JAN 2024

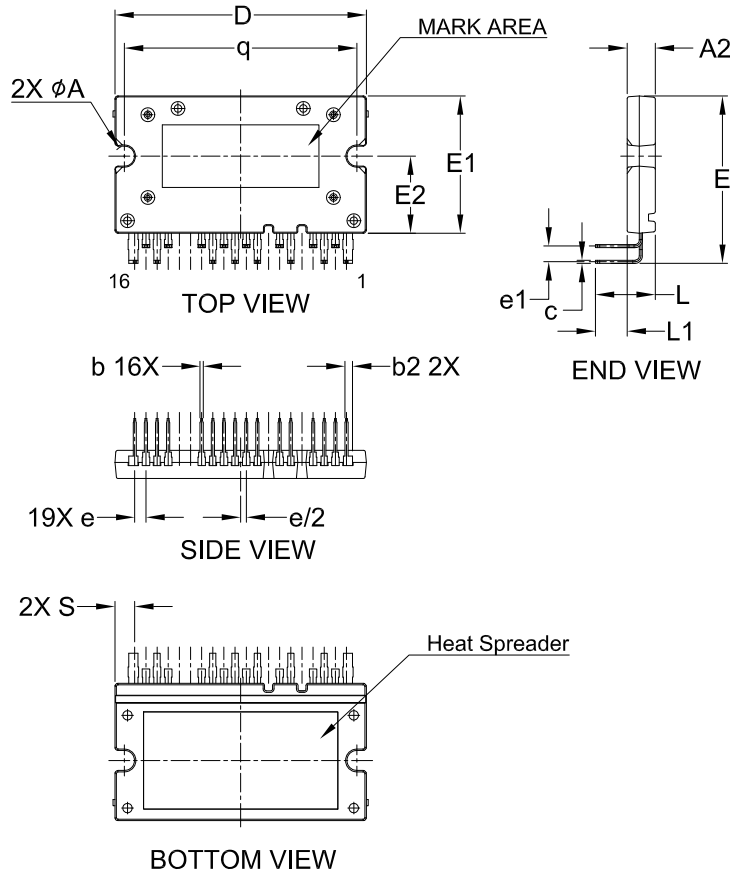
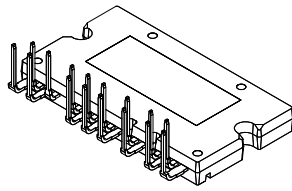

**NOTES:**

1. DIMENSIONING AND TOLERANCING PER ASME Y14.5M, 2009.
2. CONTROLLING DIMENSION: MILLIMETERS
3. DIMENSIONS ARE EXCLUSIVE OF BURRS, MOLD FLASH AND TIE BAR EXTRUSIONS.

DIM	MILLIMETERS		
	MIN.	NOM.	MAX.
A2	4.30	4.50	4.70
b	0.45	0.50	0.60
b2	1.15	1.20	1.30
c	0.45	0.50	0.60
D	39.90	40.10	40.30
E	26.20	26.70	27.20
E1	21.70	21.90	22.10
E2	12.10	12.30	12.50
e	1.478	1.778	2.078
e1	2.20	2.50	2.80
L	9.20	9.55	9.90
L1	5.05 REF		
q	36.85	37.10	37.35
S	3.159 REF		
$\phi A$	3.00	3.20	3.40

**GENERIC MARKING DIAGRAM\***

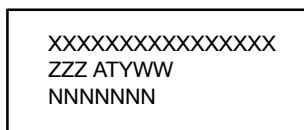

- XXXX = Specific Device Code
- ZZZ = Lot ID
- AT = Assembly & Test Location
- Y = Year
- W = Work Week
- NNN = Serial Number

\*This information is generic. Please refer to device data sheet for actual part marking. Pb-Free indicator, "G" or microdot "μ", may or may not be present. Some products may not follow the Generic Marking.

<b>DOCUMENT NUMBER:</b>	<b>98AON97133G</b>	Electronic versions are uncontrolled except when accessed directly from the Document Repository. Printed versions are uncontrolled except when stamped "CONTROLLED COPY" in red.
<b>DESCRIPTION:</b>	<b>PIM16 40.10x21.90x4.50</b>	<b>PAGE 1 OF 1</b>

onsemi and Onsemi are trademarks of Semiconductor Components Industries, LLC dba onsemi or its subsidiaries in the United States and/or other countries. onsemi reserves the right to make changes without further notice to any products herein. onsemi makes no warranty, representation or guarantee regarding the suitability of its products for any particular purpose, nor does onsemi assume any liability arising out of the application or use of any product or circuit, and specifically disclaims any and all liability, including without limitation special, consequential or incidental damages. onsemi does not convey any license under its patent rights nor the rights of others.

**onsemi**, **Onsemi**, and other names, marks, and brands are registered and/or common law trademarks of Semiconductor Components Industries, LLC dba "**onsemi**" or its affiliates and/or subsidiaries in the United States and/or other countries. **onsemi** owns the rights to a number of patents, trademarks, copyrights, trade secrets, and other intellectual property. A listing of **onsemi**'s product/patent coverage may be accessed at [www.onsemi.com/site/pdf/Patent-Marking.pdf](http://www.onsemi.com/site/pdf/Patent-Marking.pdf). **onsemi** reserves the right to make changes at any time to any products or information herein, without notice. The information herein is provided "as-is" and **onsemi** makes no warranty, representation or guarantee regarding the accuracy of the information, product features, availability, functionality, or suitability of its products for any particular purpose, nor does **onsemi** assume any liability arising out of the application or use of any product or circuit, and specifically disclaims any and all liability, including without limitation special, consequential or incidental damages. Buyer is responsible for its products and applications using **onsemi** products, including compliance with all laws, regulations and safety requirements or standards, regardless of any support or applications information provided by **onsemi**. "Typical" parameters which may be provided in **onsemi** data sheets and/or specifications can and do vary in different applications and actual performance may vary over time. All operating parameters, including "Typicals" must be validated for each customer application by customer's technical experts. **onsemi** does not convey any license under any of its intellectual property rights nor the rights of others. **onsemi** products are not designed, intended, or authorized for use as a critical component in life support systems or any FDA Class 3 medical devices or medical devices with a same or similar classification in a foreign jurisdiction or any devices intended for implantation in the human body. Should Buyer purchase or use **onsemi** products for any such unintended or unauthorized application, Buyer shall indemnify and hold **onsemi** and its officers, employees, subsidiaries, affiliates, and distributors harmless against all claims, costs, damages, and expenses, and reasonable attorney fees arising out of, directly or indirectly, any claim of personal injury or death associated with such unintended or unauthorized use, even if such claim alleges that **onsemi** was negligent regarding the design or manufacture of the part. **onsemi** is an Equal Opportunity/Affirmative Action Employer. This literature is subject to all applicable copyright laws and is not for resale in any manner.

## ADDITIONAL INFORMATION

### TECHNICAL PUBLICATIONS:

Technical Library: [www.onsemi.com/design/resources/technical-documentation](http://www.onsemi.com/design/resources/technical-documentation)  
onsemi Website: [www.onsemi.com](http://www.onsemi.com)

### ONLINE SUPPORT: [www.onsemi.com/support](http://www.onsemi.com/support)

For additional information, please contact your local Sales Representative at [www.onsemi.com/support/sales](http://www.onsemi.com/support/sales)