

MOSFET – N-Channel, SUPERFET® II

600 V, 22 A, 170 mΩ

FCH170N60

Description

SUPERFET II MOSFET is onsemi’s brand-new high voltage super-junction (SJ) MOSFET family that is utilizing charge balance technology for outstanding low on-resistance and lower gate charge performance. This advanced technology is tailored to minimize conduction loss, provide superior switching performance, and withstand extreme dv/dt rate and higher avalanche energy. Consequently, SUPERFET II MOSFET is suitable for various AC/DC power conversion for system miniaturization and higher efficiency.

Features

- 650 V @ $T_J = 150^\circ\text{C}$
- Typ. $R_{DS(on)} = 150\text{ m}\Omega$
- Ultra Low Gate Charge (Typ. $Q_g = 42\text{ nC}$)
- Low Effective Output Capacitance (Typ. $C_{oss(eff.)} = 190\text{ pF}$)
- 100% Avalanche Tested
- This Device is Pb-Free, Halide Free and is RoHS Compliant

Applications

- Telecom / Server Power Supplies
- Industrial Power Supplies
- AC-DC Power Supply

V_{DSS}	$R_{DS(ON)}\text{ MAX}$	$I_D\text{ MAX}$
600 V	170 mΩ	22 A

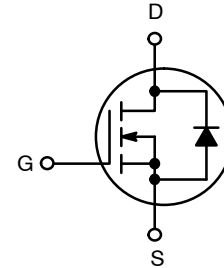

N-Channel MOSFET

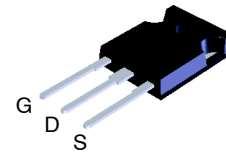

TO-247
CASE 340CK

MARKING DIAGRAM

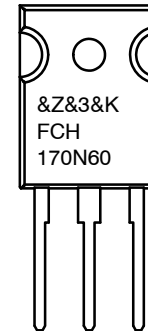

- &Z = Assembly Plant Code
- &3 = Data Code (Year & Week)
- &K = Lot Code
- FCH170N60 = Specific Device Code

ORDERING INFORMATION

See detailed ordering and shipping information on page 2 of this data sheet.

FCH170N60

ABSOLUTE MAXIMUM RATINGS (T_C = 25°C, Unless otherwise noted)

Symbol	Parameter	Value	Unit
V _{DSS}	Drain to Source Voltage	600	V
V _{GSS}	Gate to Source Voltage	-DC	±20
		-AC (f > 1 Hz)	±30
I _D	Drain Current	-Continuous (T _C = 25°C)	22
		-Continuous (T _C = 100°C)	14
I _{DM}	Drain Current	-Pulsed (Note 1)	66
E _{AS}	Single Pulsed Avalanche Energy (Note 2)	525	mJ
I _{AS}	Avalanche Current	5	A
E _{AR}	Repetitive Avalanche Energy (Note 1)	2.27	mJ
dv/dt	MOSFET dv/dt (Note 3)	100	V/ns
	Peak Diode Recovery dv/dt	20	
P _D	Power Dissipation	(T _C = 25°C)	227
		-Derate Above 25°C	1.82
T _J , T _{STG}	Operating and Storage Temperature Range	-55 to +150	°C
T _L	Maximum Lead Temperature for Soldering, 1/8" from Case for 5 s	300	°C

Stresses exceeding those listed in the Maximum Ratings table may damage the device. If any of these limits are exceeded, device functionality should not be assumed, damage may occur and reliability may be affected.

1. Repetitive rating: pulse-width limited by maximum junction temperature.
2. I_{AS} = 5 A, R_G = 25 Ω, Starting T_J = 25°C.
3. I_{SD} ≤ 11 A, di/dt ≤ 200 A/μs, V_{DD} ≤ 380 V, Starting T_J = 25°C.

THERMAL CHARACTERISTICS

Symbol	Parameter	Value	Unit
R _{θJC}	Thermal Resistance, Junction to Case, Max.	0.55	°C/W
R _{θJA}	Thermal Resistance, Junction to Ambient, Max.	40	

PACKAGE MARKING AND ORDERING INFORMATION

Part Number	Top Marking	Package	Reel Size	Tape Width	Quantity
FCH170N60	FCH170N60	TO-247	-	-	30 Units

FCH170N60

ELECTRICAL CHARACTERISTICS ($T_C = 25^\circ\text{C}$ unless otherwise noted)

Symbol	Parameter	Test Conditions	Min	Typ	Max	Unit
--------	-----------	-----------------	-----	-----	-----	------

OFF CHARACTERISTICS

BV _{DSS}	Drain to Source Breakdown Voltage	V _{GS} = 0 V, I _D = 10 mA, T _J = 25°C	600	–	–	V
		V _{GS} = 0 V, I _D = 10 mA, T _J = 150°C	650	–	–	V
ΔBV _{DSS} /ΔT _J	Breakdown Voltage Temperature Coefficient	I _D = 10 mA, Referenced to 25°C	–	0.67	–	V/°C
I _{DSS}	Zero Gate Voltage Drain Current	V _{DS} = 600 V, V _{GS} = 0 V	–	–	1	μA
		V _{DS} = 480 V, V _{GS} = 0 V, T _C = 125°C	–	1.2	–	
I _{GSS}	Gate to Body Leakage Current	V _{GS} = ±20 V, V _{DS} = 0 V	–	–	±100	nA

ON CHARACTERISTICS

V _{GS(th)}	Gate Threshold Voltage	V _{GS} = V _{DS} , I _D = 250 μA	2.5	–	3.5	V
R _{DS(on)}	Static Drain to Source On Resistance	V _{GS} = 10 V, I _D = 11 A	–	150	170	mΩ
g _{FS}	Forward Transconductance	V _{DS} = 20 V, I _D = 11 A	–	17	–	S

DYNAMIC CHARACTERISTICS

C _{iss}	Input Capacitance	V _{DS} = 380 V, V _{GS} = 0 V, f = 1 MHz	–	2150	2860	pF
C _{oss}	Output Capacitance		–	60	80	pF
C _{rss}	Reverse Transfer Capacitance		–	2.65	–	pF
C _{oss(eff.)}	Effective Output Capacitance	V _{DS} = 0 V to 480 V, V _{GS} = 0 V	–	190	–	pF
Q _{g(tot)}	Total Gate Charge at 10 V	V _{DS} = 380 V, I _D = 11 A, V _{GS} = 10 V (Note 4)	–	42	55	nC
Q _{gs}	Gate to Source Gate Charge		–	9	–	nC
Q _{gd}	Gate to Drain "Miller" Charge		–	11	–	nC
ESR	Equivalent Series Resistance	f = 1 MHz	–	0.95	–	Ω

SWITCHING CHARACTERISTICS

t _{d(on)}	Turn-On Delay Time	V _{DD} = 380 V, I _D = 11 A, V _{GS} = 10 V, R _G = 4.7 Ω (Note 4)	–	21	50	ns
t _r	Turn-On Rise Time		–	12	35	ns
t _{d(off)}	Turn-Off Delay Time		–	55	120	ns
t _f	Turn-Off Fall Time		–	3.8	18	ns

DRAIN-SOURCE- DIODE CHARACTERISTICS

I _S	Maximum Continuous Drain to Source Diode Forward Current		–	–	22	A
I _{SM}	Maximum Pulsed Drain to Source Diode Forward Current		–	–	66	A
V _{SD}	Drain to Source Diode Forward Voltage	V _{GS} = 0 V, I _{SD} = 11 A	–	–	1.2	V
t _{rr}	Reverse Recovery Time	V _{GS} = 0 V, I _{SD} = 11 A, dI _F /dt = 100 A/μs	–	346	–	ns
Q _{rr}	Reverse Recovery Charge		–	6.2	–	μC

Product parametric performance is indicated in the Electrical Characteristics for the listed test conditions, unless otherwise noted. Product performance may not be indicated by the Electrical Characteristics if operated under different conditions.

4. Essentially independent of operating temperature.

TYPICAL PERFORMANCE CHARACTERISTICS

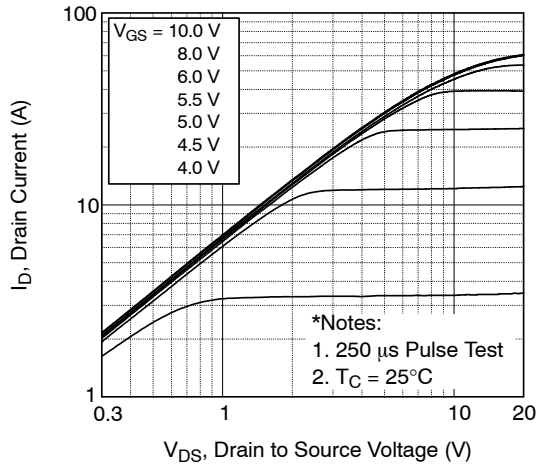

Figure 1. On-Region Characteristics

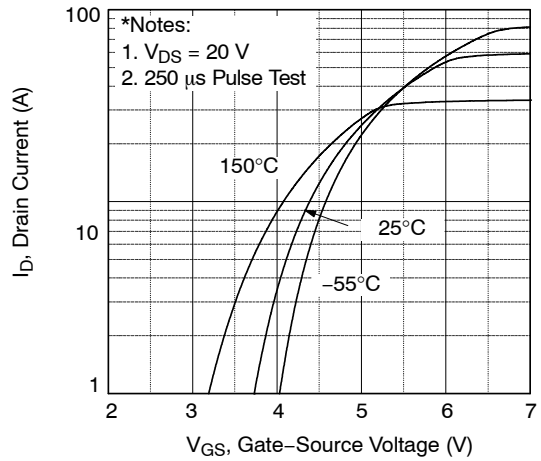

Figure 2. Transfer Characteristics

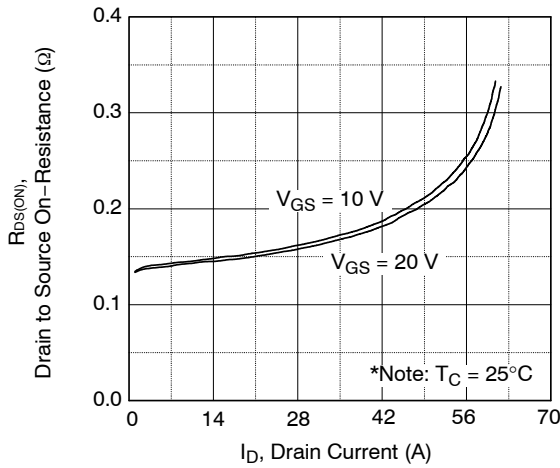

Figure 3. On-Resistance Variation vs. Drain Current and Gate Voltage

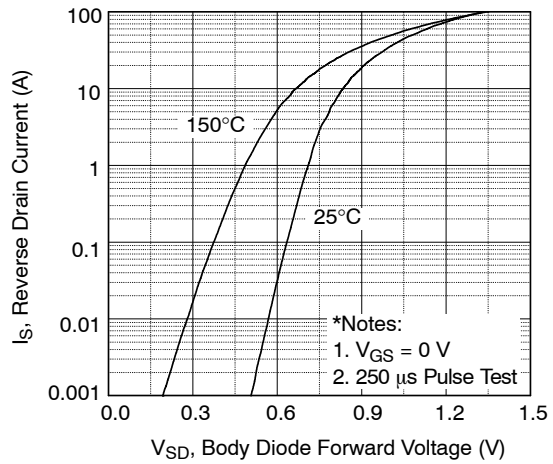

Figure 4. Body Diode Forward Voltage Variation vs. Source Current and Temperature

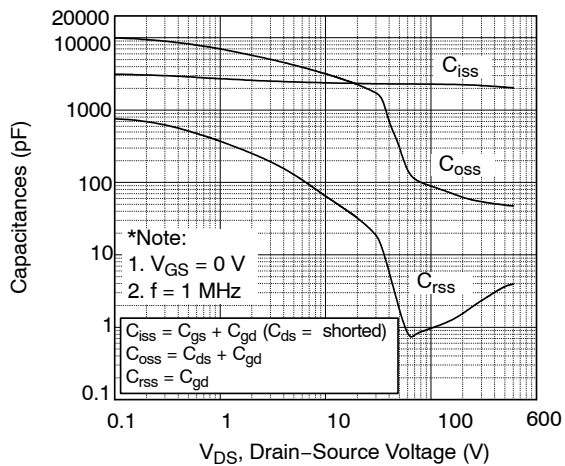

Figure 5. Capacitance Characteristics

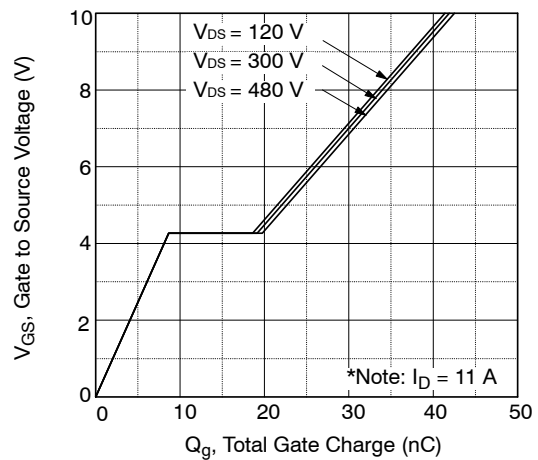

Figure 6. Gate Charge Characteristics

TYPICAL PERFORMANCE CHARACTERISTICS (continued)

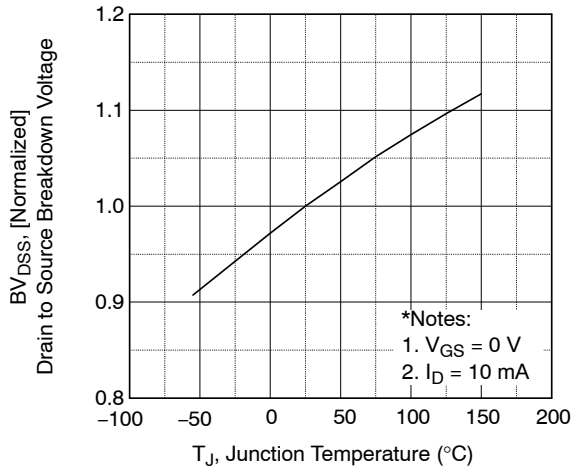

Figure 7. Breakdown Voltage Variation vs. Temperature

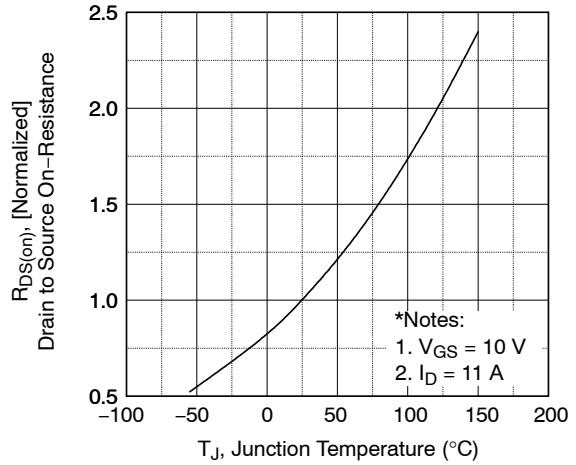

Figure 8. On-Resistance Variation vs. Temperature

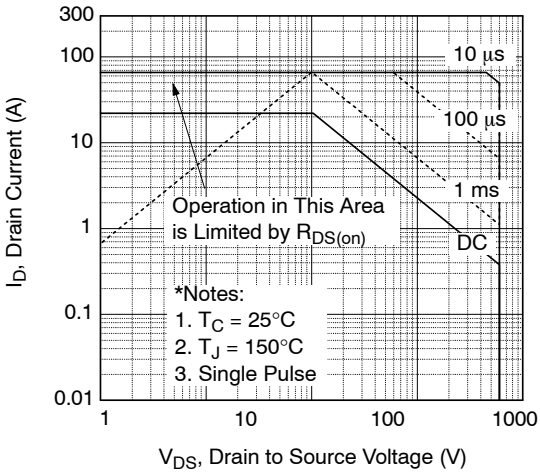

Figure 9. Maximum Safe Operation Area

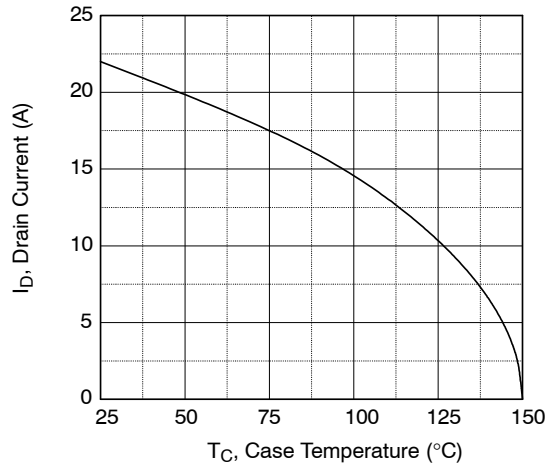

Figure 10. Maximum Drain Current vs. Case Temperature

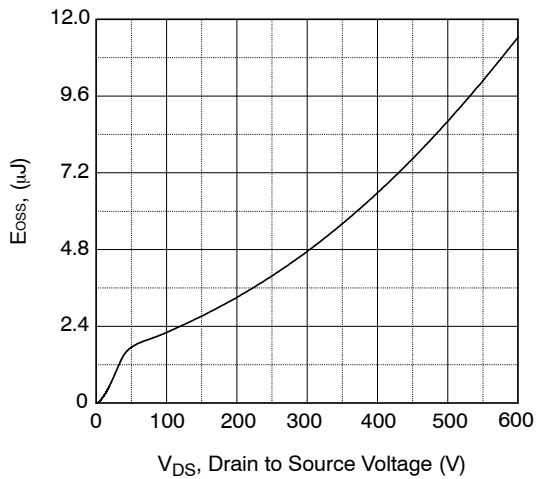

Figure 11. E_{OSS} vs. Drain to Source Voltage

FCH170N60

TYPICAL PERFORMANCE CHARACTERISTICS (continued)

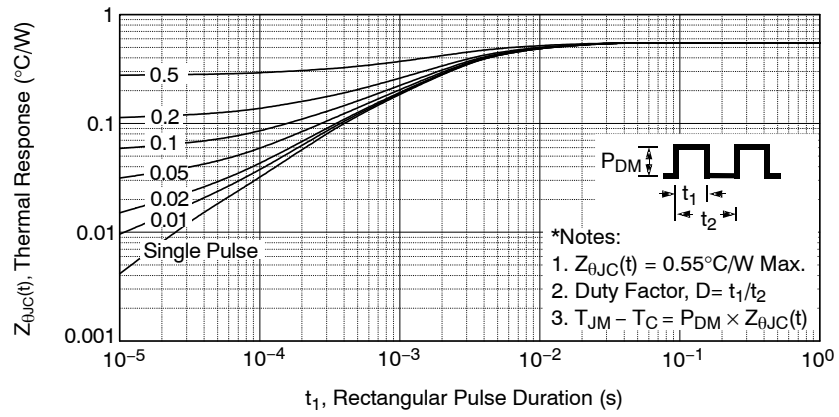

Figure 12. Transient Thermal Response Curve



Figure 13. Gate Charge Test Circuit & Waveform



Figure 14. Resistive Switching Test Circuit & Waveforms

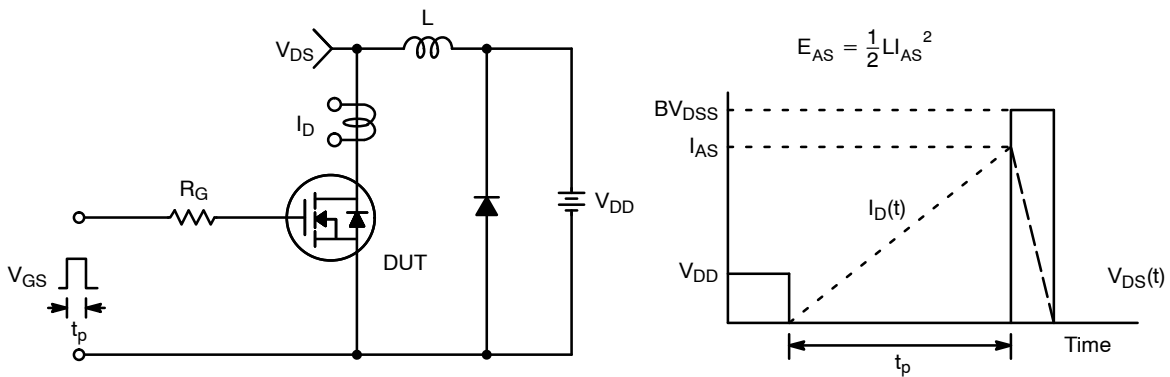

Figure 15. Unclamped Inductive Switching Test Circuit & Waveforms

FCH170N60

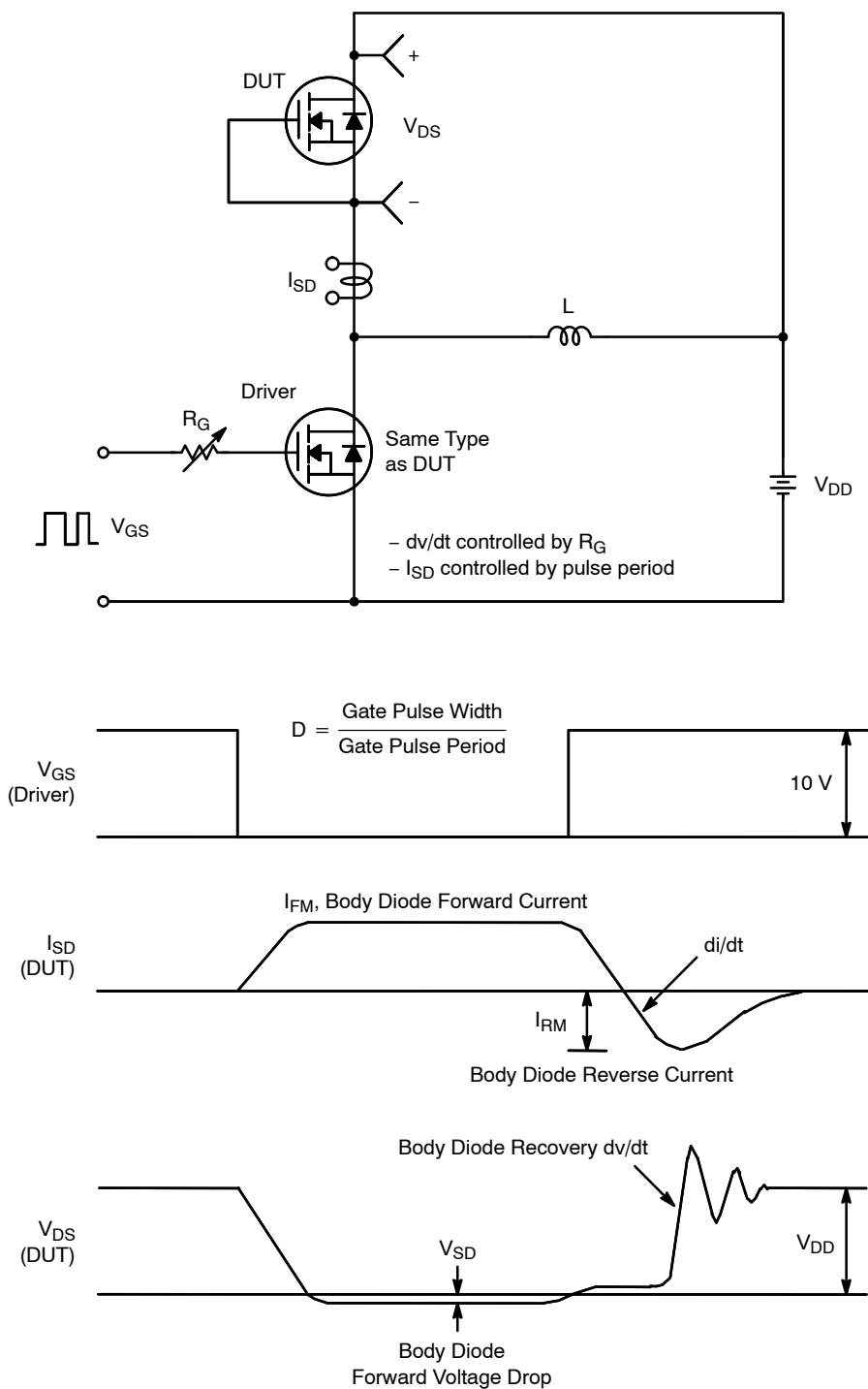

Figure 16. Peak Diode Recovery dv/dt Test Circuit & Waveforms



TO-247-3LD SHORT LEAD
CASE 340CK
ISSUE A

DATE 31 JAN 2019



NOTES: UNLESS OTHERWISE SPECIFIED.

- A. DIMENSIONS ARE EXCLUSIVE OF BURRS, MOLD FLASH, AND TIE BAR EXTRUSIONS.
- B. ALL DIMENSIONS ARE IN MILLIMETERS.
- C. DRAWING CONFORMS TO ASME Y14.5 - 2009.
- D. DIMENSION A1 TO BE MEASURED IN THE REGION DEFINED BY L1.
- E. LEAD FINISH IS UNCONTROLLED IN THE REGION DEFINED BY L1.

GENERIC MARKING DIAGRAM*



XXXX = Specific Device Code
 A = Assembly Location
 Y = Year
 WW = Work Week
 ZZ = Assembly Lot Code

*This information is generic. Please refer to device data sheet for actual part marking. Pb-Free indicator, "G" or microdot "•", may or may not be present. Some products may not follow the Generic Marking.

DIM	MILLIMETERS		
	MIN	NOM	MAX
A	4.58	4.70	4.82
A1	2.20	2.40	2.60
A2	1.40	1.50	1.60
b	1.17	1.26	1.35
b2	1.53	1.65	1.77
b4	2.42	2.54	2.66
c	0.51	0.61	0.71
D	20.32	20.57	20.82
D1	13.08	~	~
D2	0.51	0.93	1.35
E	15.37	15.62	15.87
E1	12.81	~	~
E2	4.96	5.08	5.20
e	~	5.56	~
L	15.75	16.00	16.25
L1	3.69	3.81	3.93
∅P	3.51	3.58	3.65
∅P1	6.60	6.80	7.00
Q	5.34	5.46	5.58
S	5.34	5.46	5.58

DOCUMENT NUMBER:	98AON13851G	Electronic versions are uncontrolled except when accessed directly from the Document Repository. Printed versions are uncontrolled except when stamped "CONTROLLED COPY" in red.
DESCRIPTION:	TO-247-3LD SHORT LEAD	PAGE 1 OF 1

ON Semiconductor and are trademarks of Semiconductor Components Industries, LLC dba ON Semiconductor or its subsidiaries in the United States and/or other countries. ON Semiconductor reserves the right to make changes without further notice to any products herein. ON Semiconductor makes no warranty, representation or guarantee regarding the suitability of its products for any particular purpose, nor does ON Semiconductor assume any liability arising out of the application or use of any product or circuit, and specifically disclaims any and all liability, including without limitation special, consequential or incidental damages. ON Semiconductor does not convey any license under its patent rights nor the rights of others.

onsemi, **Onsemi**, and other names, marks, and brands are registered and/or common law trademarks of Semiconductor Components Industries, LLC dba "**onsemi**" or its affiliates and/or subsidiaries in the United States and/or other countries. **onsemi** owns the rights to a number of patents, trademarks, copyrights, trade secrets, and other intellectual property. A listing of **onsemi**'s product/patent coverage may be accessed at www.onsemi.com/site/pdf/Patent-Marking.pdf. **onsemi** reserves the right to make changes at any time to any products or information herein, without notice. The information herein is provided "as-is" and **onsemi** makes no warranty, representation or guarantee regarding the accuracy of the information, product features, availability, functionality, or suitability of its products for any particular purpose, nor does **onsemi** assume any liability arising out of the application or use of any product or circuit, and specifically disclaims any and all liability, including without limitation special, consequential or incidental damages. Buyer is responsible for its products and applications using **onsemi** products, including compliance with all laws, regulations and safety requirements or standards, regardless of any support or applications information provided by **onsemi**. "Typical" parameters which may be provided in **onsemi** data sheets and/or specifications can and do vary in different applications and actual performance may vary over time. All operating parameters, including "Typicals" must be validated for each customer application by customer's technical experts. **onsemi** does not convey any license under any of its intellectual property rights nor the rights of others. **onsemi** products are not designed, intended, or authorized for use as a critical component in life support systems or any FDA Class 3 medical devices or medical devices with a same or similar classification in a foreign jurisdiction or any devices intended for implantation in the human body. Should Buyer purchase or use **onsemi** products for any such unintended or unauthorized application, Buyer shall indemnify and hold **onsemi** and its officers, employees, subsidiaries, affiliates, and distributors harmless against all claims, costs, damages, and expenses, and reasonable attorney fees arising out of, directly or indirectly, any claim of personal injury or death associated with such unintended or unauthorized use, even if such claim alleges that **onsemi** was negligent regarding the design or manufacture of the part. **onsemi** is an Equal Opportunity/Affirmative Action Employer. This literature is subject to all applicable copyright laws and is not for resale in any manner.

ADDITIONAL INFORMATION

TECHNICAL PUBLICATIONS:

Technical Library: www.onsemi.com/design/resources/technical-documentation
onsemi Website: www.onsemi.com

ONLINE SUPPORT: www.onsemi.com/support

For additional information, please contact your local Sales Representative at www.onsemi.com/support/sales