

# MOSFET – N 沟道, SUPERFET®

600 V, 35 A, 98 mΩ

## FCH35N60

### 说明

SUPERFET MOSFET 是飞兆半导体第一代利用电荷平衡技术实现出色低导通电阻和更低栅极电荷性能的高压超级结 (SJ) MOSFET 系列产品。这项技术专用于最小化导通损耗并提供卓越的开关性能、 $dv/dt$  额定值和更高雪崩能量。因此，SUPERFET MOSFET 非常适用于开关电源应用，如功率因数校正 (PFC)、服务器 / 电信电源、平板电视电源、ATX 电源及工业电源应用等。

### 特性

- 650 V @  $T_J = 150^\circ\text{C}$
- Typ.  $R_{DS(on)} = 79\text{ m}\Omega$
- 超低栅极电荷 (典型值  $Q_g = 139\text{ nC}$ )
- 低有效输出电容 (典型值  $C_{oss(eff.)} = 340\text{ pF}$ )
- 100% 经过雪崩测试
- This is a Pb-Free Device

### 应用

- 太阳能逆变器
- AC-DC 电源



ON Semiconductor®

[www.onsemi.cn](http://www.onsemi.cn)

$V_{DS}$	$R_{DS(on)}\text{ MAX}$	$I_D\text{ MAX}$
600 V	98 mΩ @ 10 V	35 A

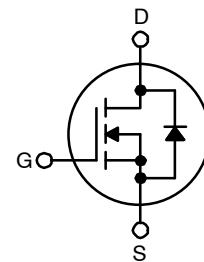

N-CHANNEL MOSFET

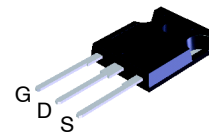

TO-247-3LD  
CASE 340CK

### MARKING DIAGRAM

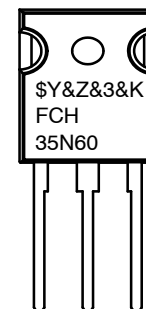

\$Y	= ON Semiconductor Logo
&Z	= Assembly Plant Code
&3	= Numeric Date Code
&K	= Lot Code
FCH35N60	= Specific Device Code

### ORDERING INFORMATION

See detailed ordering and shipping information on page 2 of this data sheet.

# FCH35N60

## MOSFET 最大额定值 ( $T_C = 25^\circ\text{C}$ 除非另有说明)

符号	参数	FCH35N60	单位
$V_{DSS}$	漏极-源极电压	600	V
$V_{GSS}$	栅极至源极电压	$\pm 30$	V
$I_D$	漏极电流	- 连续 ( $T_C = 25^\circ\text{C}$ )	35
		- 连续 ( $T_C = 100^\circ\text{C}$ )	22.2
$I_{DM}$	漏极电流	- 脉冲(注 1)	105
$E_{AS}$	单脉冲雪崩能量 (注 2)	1455	mJ
$I_{AR}$	雪崩电流 (注 1)	35	A
$E_{AR}$	重复雪崩能量 (注 1)	31.25	mJ
dv/dt	二极管恢复 dv/dt 峰值 (注 3)	20	V/ns
$P_D$	功耗	( $T_C = 25^\circ\text{C}$ )	312.5
		- 高于 $25^\circ\text{C}$ 的功耗系数	2.5
$T_J, T_{STG}$	工作和存储温度范围	-55 至 + 150	$^\circ\text{C}$
$T_L$	用于焊接的最大引脚温度, 距离外壳 1/8", 持续 5 秒	300	$^\circ\text{C}$

Stresses exceeding those listed in the Maximum Ratings table may damage the device. If any of these limits are exceeded, device functionality should not be assumed, damage may occur and reliability may be affected.

(参考译文)

如果电压超过最大额定值表中列出的值范围, 器件可能会损坏。如果超过任何这些限值, 将无法保证器件功能, 可能会导致器件损坏, 影响可靠性。

\*漏极电流受限于最大结温。

1. 重复额定值: 脉冲宽度受限于最大结温。

2.  $I_{AS} = 17.5\text{ A}$ ,  $V_{DD} = 50\text{ V}$ ,  $R_G = 25\ \Omega$ , 开始于  $T_J = 25^\circ\text{C}$

3.  $I_{SD} \leq 35\text{ A}$ ,  $di/dt \leq 200\text{ A}/\mu\text{s}$ ,  $V_{DD} \leq BV_{DSS}$ , 开始于  $T_J = 25^\circ\text{C}$

## 封装标识与订购信息

器件编号	顶标	封装	包装方法	卷尺寸	带宽	数量
FCH35N60	FCH35N60	TO-247-3LD	Tube	-	-	30 颗

## 热性能

符号	参数	FCH35N60	单位
$R_{\theta JC}$	结至外壳热阻最大值	0.4	$^\circ\text{C}/\text{W}$
$R_{\theta JA}$	结至环境热阻最大值	42	

# FCH35N60

电气特性 ( $T_C = 25^\circ\text{C}$  除非另有说明)

符号	参数	测试条件	最小值	典型值	最大值	单位
----	----	------	-----	-----	-----	----

## 关断特性

BV <sub>DSS</sub>	漏极 - 源极击穿电压	$I_D = 250 \mu\text{A}, V_{GS} = 0 \text{ V}, T_J = 25^\circ\text{C}$	600	-	-	V
		$I_D = 250 \mu\text{A}, V_{GS} = 0 \text{ V}, T_J = 150^\circ\text{C}$	-	650	-	
$\Delta BV_{DSS} / \Delta T_J$	击穿电压温度系数	$I_D = 250 \mu\text{A}$ , 参考 $25^\circ\text{C}$ 数值	-	0.6	-	V/ $^\circ\text{C}$
BV <sub>DS</sub>	漏源极雪崩击穿电压	$V_{GS} = 0 \text{ V}, I_D = 16 \text{ A}$	-	700	-	V
I <sub>DSS</sub>	零栅极电压漏极电流	$V_{DS} = 600 \text{ V}, V_{GS} = 0 \text{ V}$	-	-	1	$\mu\text{A}$
		$V_{DS} = 480 \text{ V}, T_C = 125^\circ\text{C}$	-	-	10	
I <sub>GSS</sub>	栅极 - 体漏电流	$V_{GS} = \pm 30 \text{ V}, V_{DS} = 0 \text{ V}$	-	-	$\pm 100$	nA

## 导通特性

V <sub>GS(th)</sub>	栅极阈值电压	$V_{GS} = V_{DS}, I_D = 250 \mu\text{A}$	3.0	-	5.0	V
R <sub>DS(on)</sub>	漏极至源极静态导通电阻	$V_{GS} = 10 \text{ V}, I_D = 17.5 \text{ A}$	-	0.079	0.098	$\Omega$
g <sub>FS</sub>	正向跨导	$V_{DS} = 40 \text{ V}, I_D = 17.5 \text{ A}$	-	28.8	-	S

## 动态特性

C <sub>iss</sub>	输入电容	$V_{DS} = 25 \text{ V}, V_{GS} = 0 \text{ V}, f = 1 \text{ MHz}$	-	4990	6640	pF
C <sub>oss</sub>	输出电容		-	2380	3170	
C <sub>rss</sub>	反向传输电容		-	140	-	
C <sub>oss</sub>	输出电容	$V_{DS} = 480 \text{ V}, V_{GS} = 0 \text{ V}, f = 1 \text{ MHz}$	-	113	-	pF
C <sub>oss eff.</sub>	有效输出电容	$V_{DS} = 0 \text{ V to } 480 \text{ V}, V_{GS} = 0 \text{ V}$	-	340	-	pF
Q <sub>g</sub>	10 V 电压的栅极电荷总量	$V_{DS} = 480 \text{ V}, I_D = 35 \text{ A}, V_{GS} = 10 \text{ V}$ (注 4)	-	139	181	nC
Q <sub>gs</sub>	栅极 - 源极栅极电荷		-	31	-	
Q <sub>gd</sub>	栅极 - 漏极 “米勒” 电荷		-	69	-	
ESR	等效串联电阻 (G-S)	漏极开路, $f = 1 \text{ MHz}$	-	1.4	-	$\Omega$

## 开关特性

t <sub>d(on)</sub>	导通延迟时间	$V_{DD} = 300 \text{ V}, I_D = 35 \text{ A}, R_G = 4.7 \Omega$ (注 4)	-	34	78	ns
t <sub>r</sub>	导通上升时间		-	120	250	
t <sub>d(off)</sub>	关断延迟时间		-	105	220	
t <sub>f</sub>	关断下降时间		-	73	155	

## 漏极 - 源极二极管特性

I <sub>S</sub>	漏极 - 源极二极管最大正向连续电流	-	-	35	A	
I <sub>SM</sub>	漏极 - 源极二极管最大正向脉冲电流	-	-	105	A	
V <sub>SD</sub>	漏极 - 源极二极管正向电压	$V_{GS} = 0 \text{ V}, I_{SD} = 35 \text{ A}$	-	-	1.4	V
t <sub>rr</sub>	反向恢复时间	$V_{GS} = 0 \text{ V}, I_{SD} = 35 \text{ A}, di_F/dt = 100 \text{ A}/\mu\text{s}$	-	614	-	ns
Q <sub>rr</sub>	反向恢复电荷		-	16.3	-	

Product parametric performance is indicated in the Electrical Characteristics for the listed test conditions, unless otherwise noted. Product performance may not be indicated by the Electrical Characteristics if operated under different conditions.

(参考译文)

除非另有说明, “电气特性” 表格中列出的是所列测试条件下的产品性能参数。如果在不同条件下运行, 产品性能可能与 “电气特性” 表格中所列性能参数不一致。

4. 典型特性本质上独立于工作温度

典型特性



图 1. 导通区域特性



图 2. 传输特性

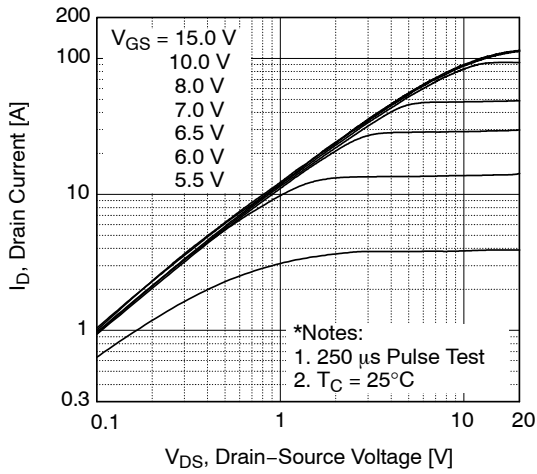

图 3. 导通电阻变化与漏极电流和栅极电压的关系

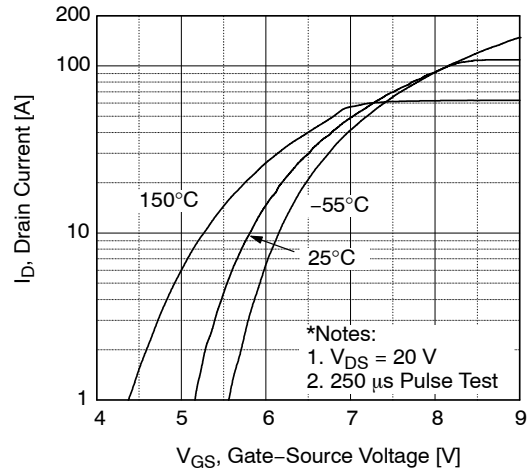

图 4. 体二极管正向电压变化与源极电流和温度的关系

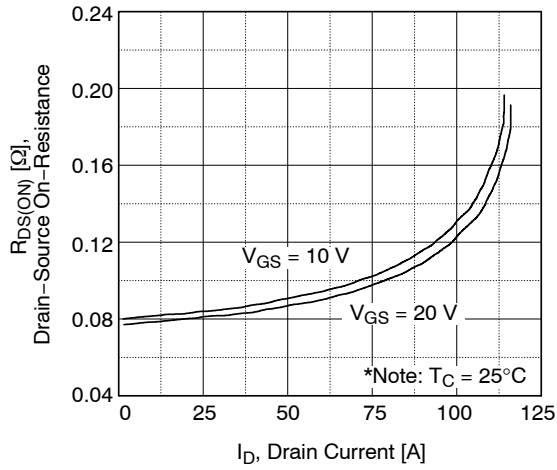

图 5. 电容特性

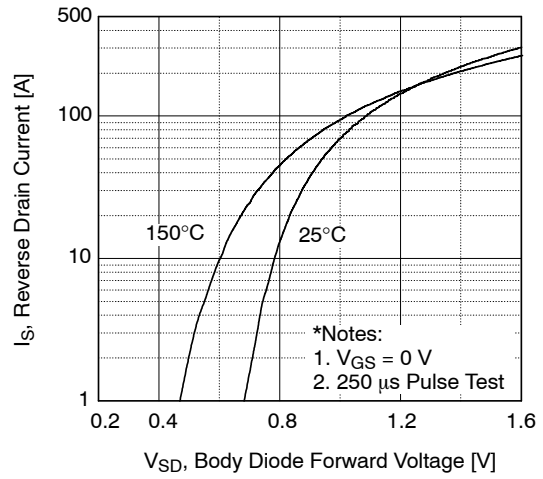

图 6. 栅极电荷特性

典型特性 (接上页)

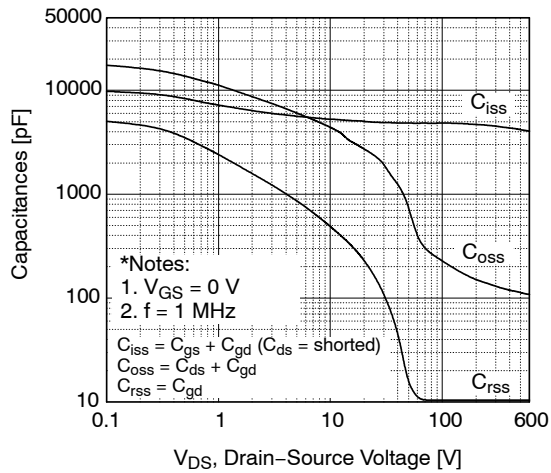

图 7. 击穿电压变化与温度的关系

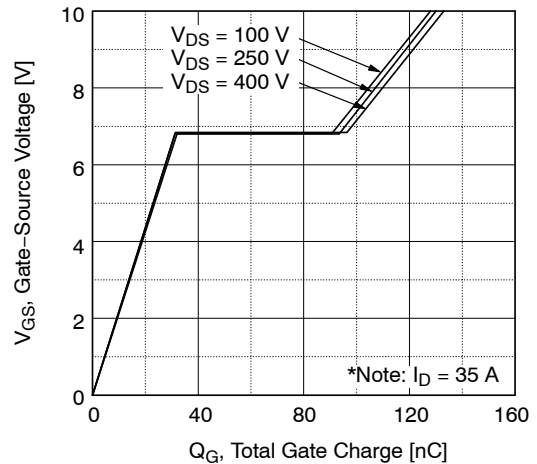

图 8. 导通电阻变化与温度的关系

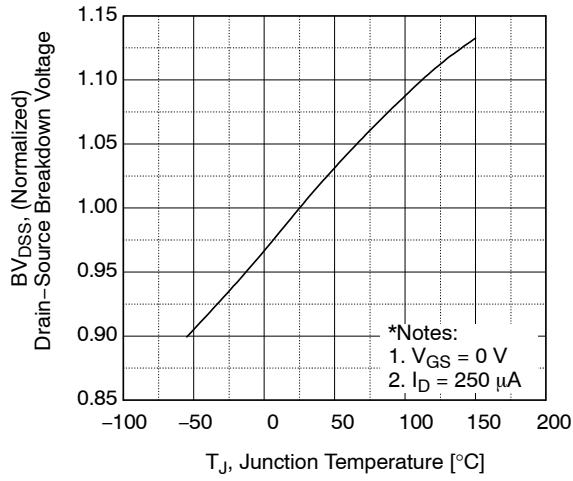

图 9. 最大安全工作区

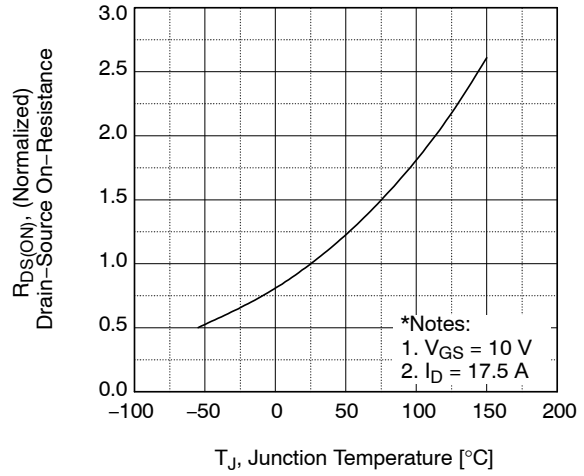

图 10. 最大漏极电流与壳温的关系

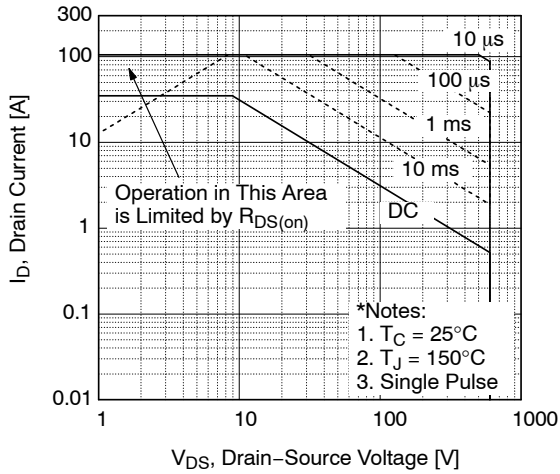

图 11. 瞬态热响应曲线

# FCH35N60

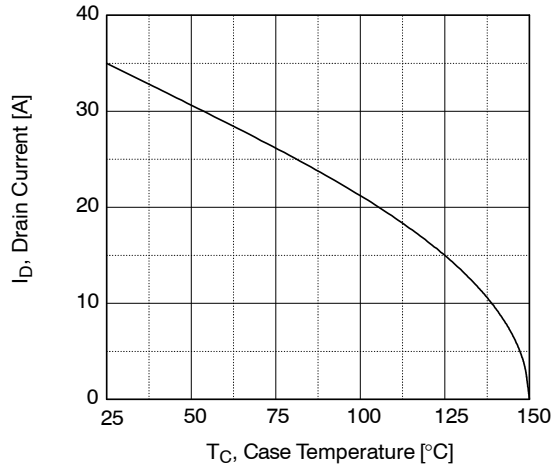

图 12. 栅极电荷测试电路与波形

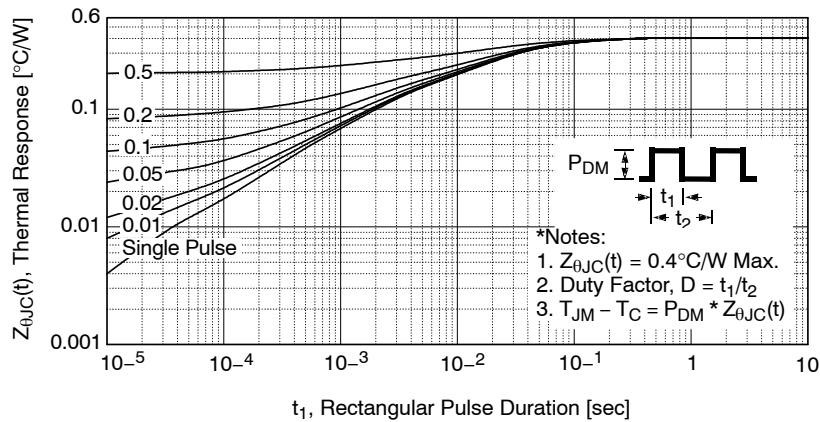

图 13. 阻性开关测试电路与波形

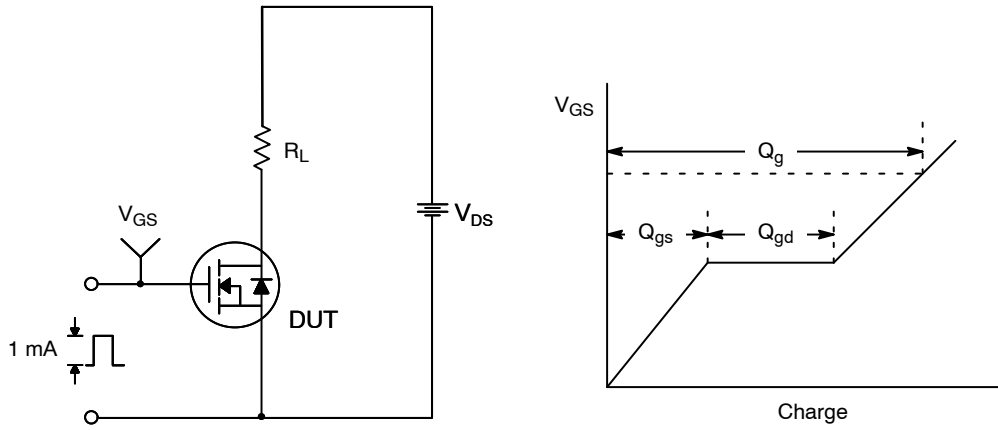

图 14. 非箝位感性开关测试电路与波形



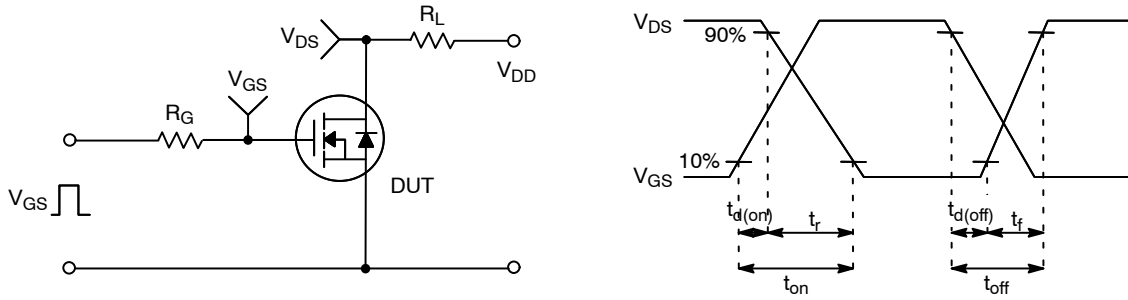

**TO-247-3LD SHORT LEAD**  
**CASE 340CK**  
**ISSUE A**

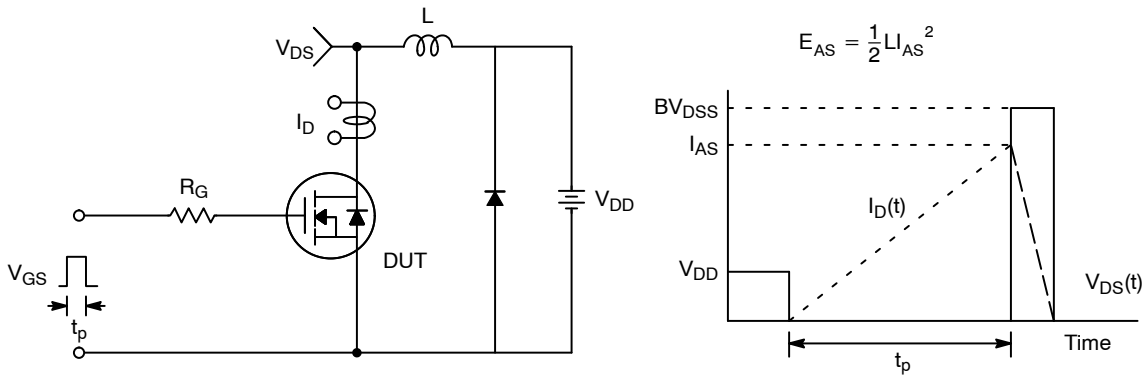
DATE 31 JAN 2019



NOTES: UNLESS OTHERWISE SPECIFIED.

- A. DIMENSIONS ARE EXCLUSIVE OF BURRS, MOLD FLASH, AND TIE BAR EXTRUSIONS.
- B. ALL DIMENSIONS ARE IN MILLIMETERS.
- C. DRAWING CONFORMS TO ASME Y14.5 - 2009.
- D. DIMENSION A1 TO BE MEASURED IN THE REGION DEFINED BY L1.
- E. LEAD FINISH IS UNCONTROLLED IN THE REGION DEFINED BY L1.

**GENERIC MARKING DIAGRAM\***



- XXXX = Specific Device Code
- A = Assembly Location
- Y = Year
- WW = Work Week
- ZZ = Assembly Lot Code

\*This information is generic. Please refer to device data sheet for actual part marking. Pb-Free indicator, "G" or microdot "•", may or may not be present. Some products may not follow the Generic Marking.

DIM	MILLIMETERS		
	MIN	NOM	MAX
A	4.58	4.70	4.82
A1	2.20	2.40	2.60
A2	1.40	1.50	1.60
b	1.17	1.26	1.35
b2	1.53	1.65	1.77
b4	2.42	2.54	2.66
c	0.51	0.61	0.71
D	20.32	20.57	20.82
D1	13.08	~	~
D2	0.51	0.93	1.35
E	15.37	15.62	15.87
E1	12.81	~	~
E2	4.96	5.08	5.20
e	~	5.56	~
L	15.75	16.00	16.25
L1	3.69	3.81	3.93
ØP	3.51	3.58	3.65
ØP1	6.60	6.80	7.00
Q	5.34	5.46	5.58
S	5.34	5.46	5.58

<b>DOCUMENT NUMBER:</b>	98AON13851G	Electronic versions are uncontrolled except when accessed directly from the Document Repository. Printed versions are uncontrolled except when stamped "CONTROLLED COPY" in red.
<b>DESCRIPTION:</b>	TO-247-3LD SHORT LEAD	<b>PAGE 1 OF 1</b>

ON Semiconductor and are trademarks of Semiconductor Components Industries, LLC dba ON Semiconductor or its subsidiaries in the United States and/or other countries. ON Semiconductor reserves the right to make changes without further notice to any products herein. ON Semiconductor makes no warranty, representation or guarantee regarding the suitability of its products for any particular purpose, nor does ON Semiconductor assume any liability arising out of the application or use of any product or circuit, and specifically disclaims any and all liability, including without limitation special, consequential or incidental damages. ON Semiconductor does not convey any license under its patent rights nor the rights of others.



**onsemi**, **Onsemi**, and other names, marks, and brands are registered and/or common law trademarks of Semiconductor Components Industries, LLC dba "**onsemi**" or its affiliates and/or subsidiaries in the United States and/or other countries. **onsemi** owns the rights to a number of patents, trademarks, copyrights, trade secrets, and other intellectual property. A listing of **onsemi**'s product/patent coverage may be accessed at [www.onsemi.com/site/pdf/Patent-Marking.pdf](http://www.onsemi.com/site/pdf/Patent-Marking.pdf). **onsemi** reserves the right to make changes at any time to any products or information herein, without notice. The information herein is provided "as-is" and **onsemi** makes no warranty, representation or guarantee regarding the accuracy of the information, product features, availability, functionality, or suitability of its products for any particular purpose, nor does **onsemi** assume any liability arising out of the application or use of any product or circuit, and specifically disclaims any and all liability, including without limitation special, consequential or incidental damages. Buyer is responsible for its products and applications using **onsemi** products, including compliance with all laws, regulations and safety requirements or standards, regardless of any support or applications information provided by **onsemi**. "Typical" parameters which may be provided in **onsemi** data sheets and/or specifications can and do vary in different applications and actual performance may vary over time. All operating parameters, including "Typicals" must be validated for each customer application by customer's technical experts. **onsemi** does not convey any license under any of its intellectual property rights nor the rights of others. **onsemi** products are not designed, intended, or authorized for use as a critical component in life support systems or any FDA Class 3 medical devices or medical devices with a same or similar classification in a foreign jurisdiction or any devices intended for implantation in the human body. Should Buyer purchase or use **onsemi** products for any such unintended or unauthorized application, Buyer shall indemnify and hold **onsemi** and its officers, employees, subsidiaries, affiliates, and distributors harmless against all claims, costs, damages, and expenses, and reasonable attorney fees arising out of, directly or indirectly, any claim of personal injury or death associated with such unintended or unauthorized use, even if such claim alleges that **onsemi** was negligent regarding the design or manufacture of the part. **onsemi** is an Equal Opportunity/Affirmative Action Employer. This literature is subject to all applicable copyright laws and is not for resale in any manner.

## ADDITIONAL INFORMATION

### TECHNICAL PUBLICATIONS:

Technical Library: [www.onsemi.com/design/resources/technical-documentation](http://www.onsemi.com/design/resources/technical-documentation)  
onsemi Website: [www.onsemi.com](http://www.onsemi.com)

### ONLINE SUPPORT: [www.onsemi.com/support](http://www.onsemi.com/support)

For additional information, please contact your local Sales Representative at [www.onsemi.com/support/sales](http://www.onsemi.com/support/sales)