



Is Now Part of



**ON Semiconductor®**

To learn more about ON Semiconductor, please visit our website at  
[www.onsemi.com](http://www.onsemi.com)

Please note: As part of the Fairchild Semiconductor integration, some of the Fairchild orderable part numbers will need to change in order to meet ON Semiconductor's system requirements. Since the ON Semiconductor product management systems do not have the ability to manage part nomenclature that utilizes an underscore (\_), the underscore (\_) in the Fairchild part numbers will be changed to a dash (-). This document may contain device numbers with an underscore (\_). Please check the ON Semiconductor website to verify the updated device numbers. The most current and up-to-date ordering information can be found at [www.onsemi.com](http://www.onsemi.com). Please email any questions regarding the system integration to [Fairchild\\_questions@onsemi.com](mailto:Fairchild_questions@onsemi.com).

ON Semiconductor and the ON Semiconductor logo are trademarks of Semiconductor Components Industries, LLC dba ON Semiconductor or its subsidiaries in the United States and/or other countries. ON Semiconductor owns the rights to a number of patents, trademarks, copyrights, trade secrets, and other intellectual property. A listing of ON Semiconductor's product/patent coverage may be accessed at [www.onsemi.com/site/pdf/Patent-Marking.pdf](http://www.onsemi.com/site/pdf/Patent-Marking.pdf). ON Semiconductor reserves the right to make changes without further notice to any products herein. ON Semiconductor makes no warranty, representation or guarantee regarding the suitability of its products for any particular purpose, nor does ON Semiconductor assume any liability arising out of the application or use of any product or circuit, and specifically disclaims any and all liability, including without limitation special, consequential or incidental damages. Buyer is responsible for its products and applications using ON Semiconductor products, including compliance with all laws, regulations and safety requirements or standards, regardless of any support or applications information provided by ON Semiconductor. "Typical" parameters which may be provided in ON Semiconductor data sheets and/or specifications can and do vary in different applications and actual performance may vary over time. All operating parameters, including "Typicals" must be validated for each customer application by customer's technical experts. ON Semiconductor does not convey any license under its patent rights nor the rights of others. ON Semiconductor products are not designed, intended, or authorized for use as a critical component in life support systems or any FDA Class 3 medical devices or medical devices with a same or similar classification in a foreign jurisdiction or any devices intended for implantation in the human body. Should Buyer purchase or use ON Semiconductor products for any such unintended or unauthorized application, Buyer shall indemnify and hold ON Semiconductor and its officers, employees, subsidiaries, affiliates, and distributors harmless against all claims, costs, damages, and expenses, and reasonable attorney fees arising out of, directly or indirectly, any claim of personal injury or death associated with such unintended or unauthorized use, even if such claim alleges that ON Semiconductor was negligent regarding the design or manufacture of the part. ON Semiconductor is an Equal Opportunity/Affirmative Action Employer. This literature is subject to all applicable copyright laws and is not for resale in any manner.

# FCP16N60N / FCPF16N60NT

## N 沟道 SupreMOS® MOSFET 600 V, 16 A, 199 mΩ

### 特性

- $R_{DS(on)} = 170 \text{ m}\Omega$  (Typ.) @  $V_{GS} = 10 \text{ V}$ ,  $I_D = 8 \text{ A}$
- 超低栅极电荷 (典型值  $Q_g = 40.2 \text{ nC}$ )
- 低有效输出电容 (典型值  $C_{oss(eff.)} = 176 \text{ pF}$ )
- 100% 经过雪崩测试
- 符合 RoHS 标准

### 应用

- LCD/LED/PDP 电视
- 照明
- 太阳能逆变器
- AC-DC 电源

### 说明

SupreMOS® MOSFET 是飞兆半导体的下一代高压超级结 (SJ) 技术, 该技术采用区别于传统 SJ MOSFET 产品的深沟槽填充工艺。这项先进技术和精密的工艺控制提供了最低的  $R_{sp}$  on-resistance (导通电阻规格), 卓越的开关性能和耐用性。SupreMOS MOSFET 产品非常适合高频开关电源转换器应用, 如功率因数校正 (PFC)、服务器 / 电信电源、平板电视电源、ATX 电源及工业电源应用。

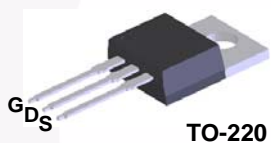

TO-220

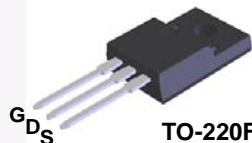

TO-220F

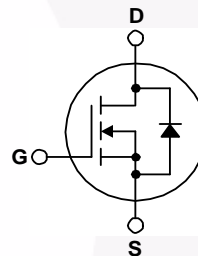

绝对最大额定值针对  $T_C = 25^\circ\text{C}$  除非另有说明。

符号	参数	FCP16N60N	FCPF16N60NT	单位
$V_{DSS}$	漏极-源极电压	600		V
$V_{GSS}$	栅极-源极电压	$\pm 30$		V
$I_D$	漏极电流	- 连续 ( $T_C = 25^\circ\text{C}$ )	16.0	16.0*
		- 连续 ( $T_C = 100^\circ\text{C}$ )	10.1	10.1*
$I_{DM}$	漏极电流 (注 1)	48.0	48.0*	A
$E_{AS}$	单脉冲雪崩能量 (注 2)	355		mJ
$I_{AR}$	雪崩电流 (注 1)	5.3		A
$E_{AR}$	重复雪崩能量 (注 1)	1.34		mJ
dv/dt	MOSFET dv/dt	100		V/ns
	二极管恢复 dv/dt 峰值 (注 3)	20		V/ns
$P_D$	功耗	( $T_C = 25^\circ\text{C}$ )	134.4	35.7
		- 超过 $25^\circ\text{C}$ 时降额	1.08	0.29
$T_J, T_{STG}$	工作和存储温度范围	-55 至 +150		$^\circ\text{C}$
$T_L$	用于焊接的最大引脚温度, 距离外壳 1/8", 持续 5 秒	300		$^\circ\text{C}$

\* 漏极电流受限于最大结温

### 热性能

符号	参数	FCP16N60N	FCPF16N60NT	单位
$R_{\theta JC}$	结至外壳热阻最大值	0.93	3.5	$^\circ\text{C}/\text{W}$
$R_{\theta JA}$	结至环境热阻最大值	62.5	62.5	

## 封装标识与订购信息

器件编号	顶标	封装	包装方法	卷尺寸	带宽	数量
FCP16N60N	FCP16N60N	TO-220	塑料管	不适用	不适用	50 单元
FCPF16N60NT	FCPF16N60NT	TO-220F	塑料管	不适用	不适用	50 单元

电气特性  $T_C = 25^\circ\text{C}$  除非另有说明。

符号	参数	测试条件	最小值	典型值	最大值	单位
----	----	------	-----	-----	-----	----

## 关断特性

$BV_{DSS}$	漏极-源极击穿电压	$I_D = 1\text{ mA}, V_{GS} = 0\text{ V}, T_C = 25^\circ\text{C}$	600	-	-	V
$\Delta BV_{DSS} / \Delta T_J$	击穿电压温度系数	$I_D = 1\text{ mA}$ , 参考 $25^\circ\text{C}$	-	0.73	-	V/ $^\circ\text{C}$
$I_{DSS}$	零栅极电压漏极电流	$V_{DS} = 480\text{ V}, V_{GS} = 0\text{ V}$	-	-	10	$\mu\text{A}$
		$V_{DS} = 480\text{ V}, V_{GS} = 0\text{ V}, T_C = 125^\circ\text{C}$	-	-	100	
$I_{GSS}$	栅极-体漏电流	$V_{GS} = \pm 30\text{ V}, V_{DS} = 0\text{ V}$	-	-	$\pm 100$	nA

## 导通特性

$V_{GS(th)}$	栅极阈值电压	$V_{GS} = V_{DS}, I_D = 250\ \mu\text{A}$	2.0	-	4.0	V
$R_{DS(on)}$	漏极至源极静态导通电阻	$V_{GS} = 10\text{ V}, I_D = 8\text{ A}$	-	0.170	0.199	$\Omega$
$g_{FS}$	正向跨导	$V_{DS} = 40\text{ V}, I_D = 8\text{ A}$	-	13	-	S

## 动态特性

$C_{iss}$	输入电容	$V_{DS} = 100\text{ V}, V_{GS} = 0\text{ V}, f = 1\text{ MHz}$	-	1630	2170	pF
$C_{oss}$	输出电容		-	70	95	pF
$C_{rss}$	反向传输电容		-	5	10	pF
$C_{oss}$	输出电容	$V_{DS} = 380\text{ V}, V_{GS} = 0\text{ V}, f = 1\text{ MHz}$	-	40	60	pF
$C_{oss(eff.)}$	有效输出电容	$V_{DS} = 0\text{ V}$ 至 $480\text{ V}, V_{GS} = 0\text{ V}$	-	176	-	pF
$Q_g(\text{tot})$	10 V 的栅极电荷总量	$V_{DS} = 380\text{ V}, I_D = 8\text{ A}, V_{GS} = 10\text{ V}$ (说明 4)	-	40.2	52.3	nC
$Q_{gs}$	栅极-源极栅极电荷		-	6.7	-	nC
$Q_{gd}$	栅极-漏极“密勒”电荷		-	12.9	-	nC
ESR	等效串联电阻 (G-S)	$f = 1\text{ MHz}$	-	2.9	-	$\Omega$

## 开关特性

$t_{d(on)}$	导通延迟时间	$V_{DD} = 380\text{ V}, I_D = 8\text{ A}, V_{GS} = 10\text{ V}, R_G = 4.7\ \Omega$ (说明 4)	-	15.8	41.6	ns
$t_r$	开通上升时间		-	15.5	41.0	ns
$t_{d(off)}$	关断延迟时间		-	60.3	130.6	ns
$t_f$	关断下降时间		-	20.2	50.4	ns

## 漏极-源极二极管特性

$I_S$	漏极-源极二极管最大正向连续电流	-	-	16	A	
$I_{SM}$	漏极-源极二极管最大正向脉冲电流	-	-	48	A	
$V_{SD}$	漏极-源极二极管正向电压	$V_{GS} = 0\text{ V}, I_{SD} = 8\text{ A}$	-	-	1.2	V
$t_{rr}$	反向恢复时间	$V_{GS} = 0\text{ V}, I_{SD} = 8\text{ A}, di_F/dt = 100\text{ A}/\mu\text{s}$	-	319	-	ns
$Q_{rr}$	反向恢复电荷		-	4.4	-	$\mu\text{C}$

注意：

1. 重复额定值：脉冲宽度受限于最大结温。
2.  $I_{AS} = 5.3\text{ A}, R_G = 25\ \Omega$ , 启动  $T_J = 25^\circ\text{C}$ 。
3.  $I_{SD} \leq 16\text{ A}, di/dt \leq 200\text{ A}/\mu\text{s}, V_{DD} = 380\text{ V}$ , 启动  $T_J = 25^\circ\text{C}$ 。
4. 本质上独立于工作温度的典型特性。

典型性能特征

图 1. 导通区域特性



图 2. 传输特性



图 3. 导通电阻变化与漏极电流和栅极电压

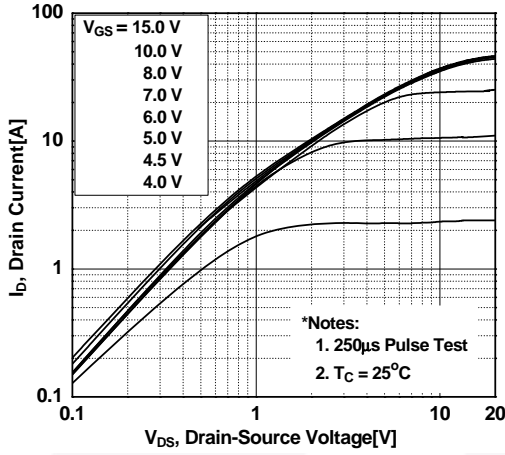

图 4. 体二极管正向电压变化与源极电流和温度

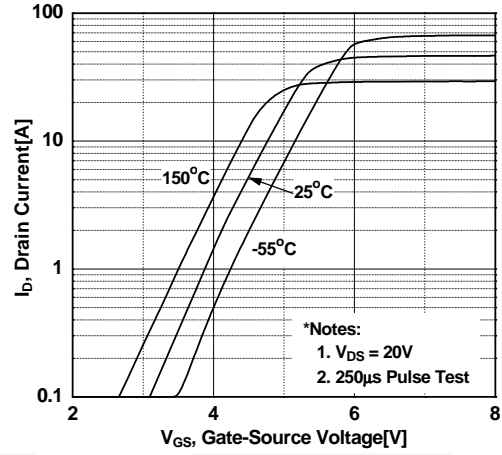

图 5. 电容特性

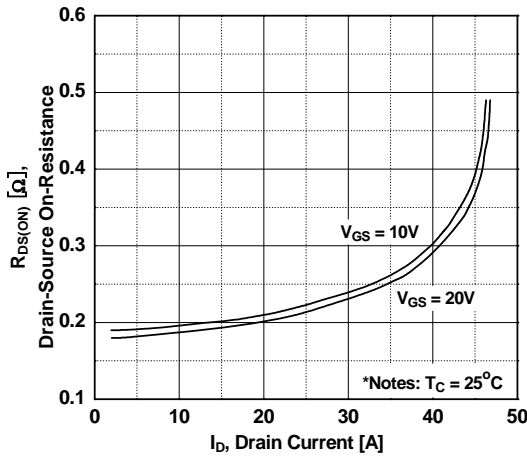

图 6. 栅极电荷

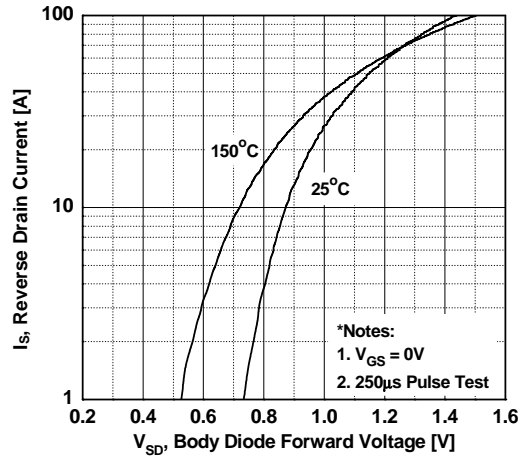

典型性能特征 (接上页)

图 7. 击穿电压变化与温度

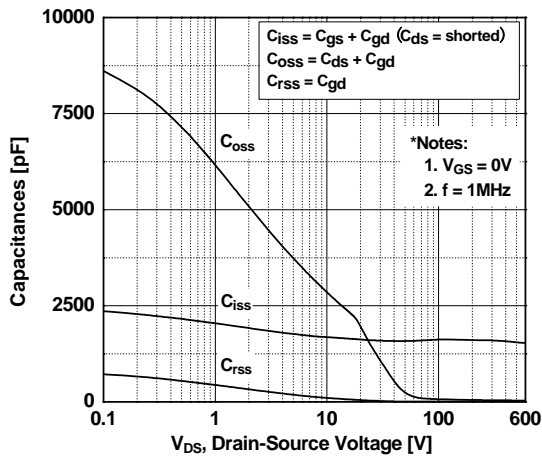
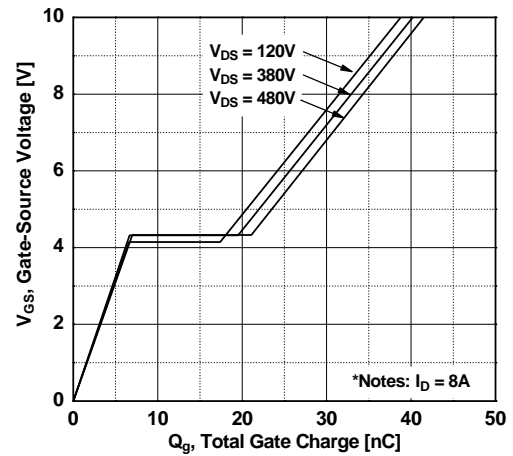

图 8. 导通电阻变化与温度



图 9. 最大安全工作区用于 FCP16N60N

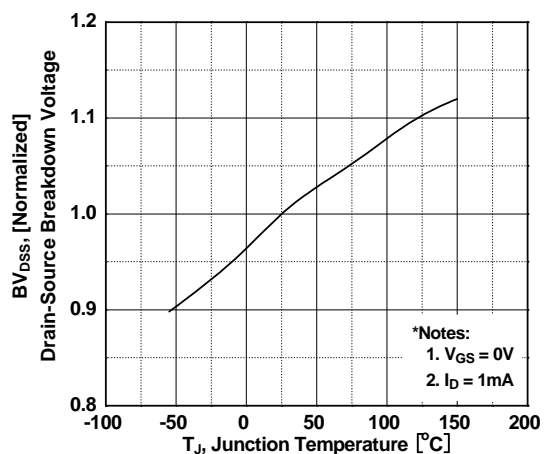

图 10. 最大安全操作区用于 FCPF16N60NT

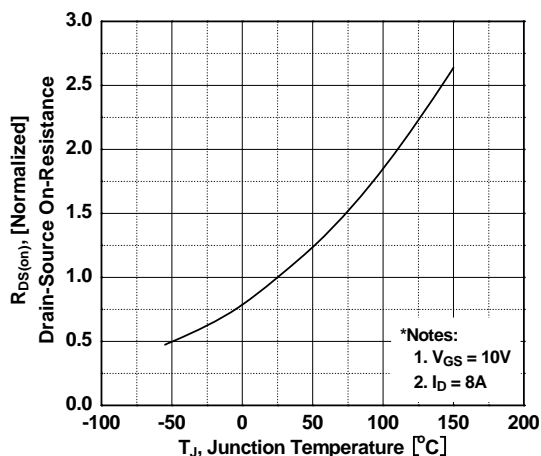

图 11. 最大漏极电流与壳体温度

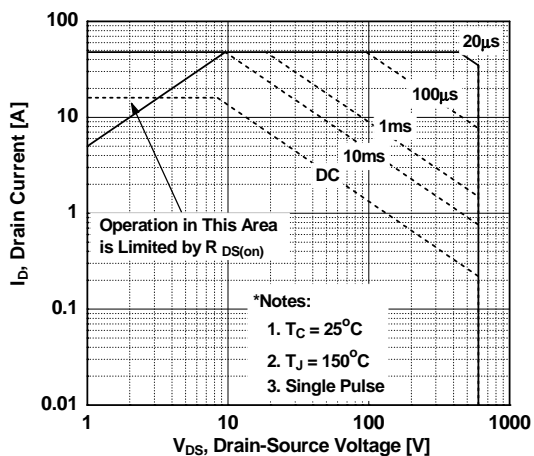

典型性能特征 (接上页)

图 12. 用于 FCP16N60N 的瞬态热响应曲线

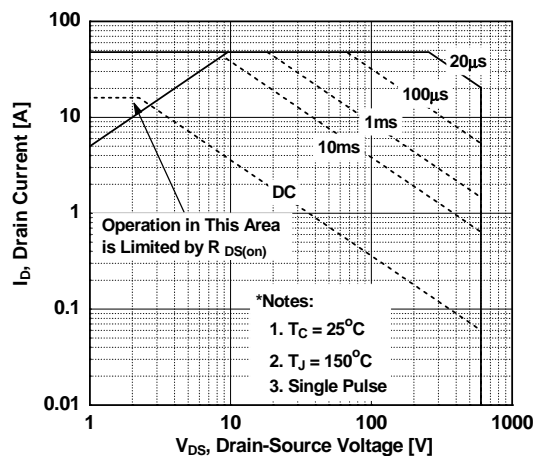
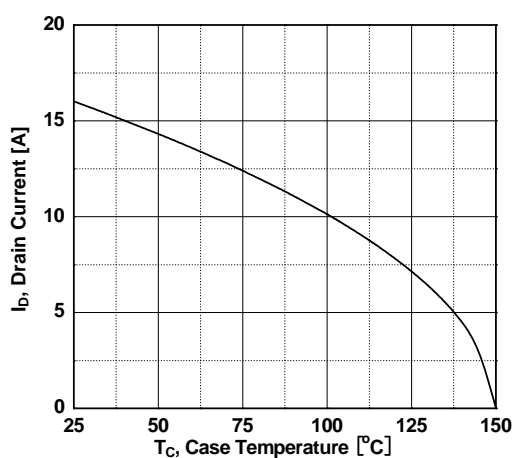

图 13. 用于 FCPF16N60NT 的瞬态热响应曲线





图 14. 栅极电荷测试电路与波形

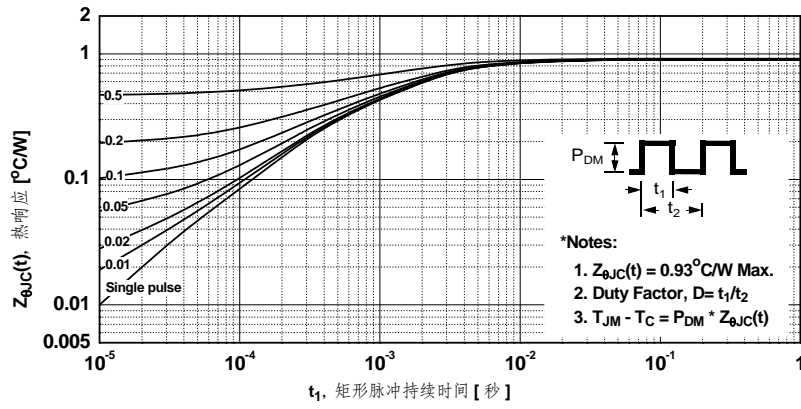
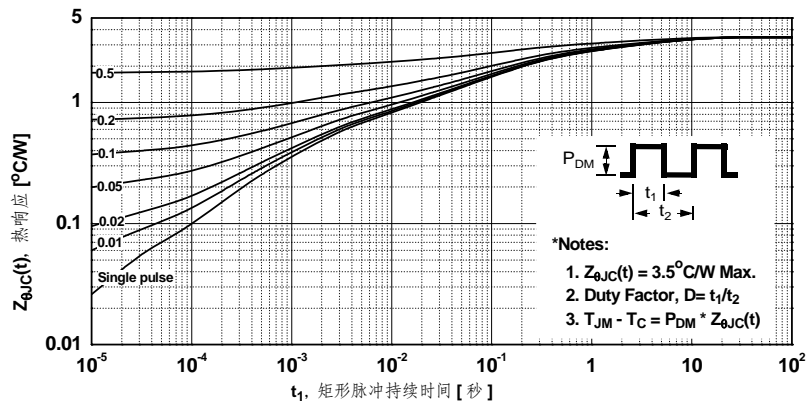

图 15. 阻性开关测试电路与波形

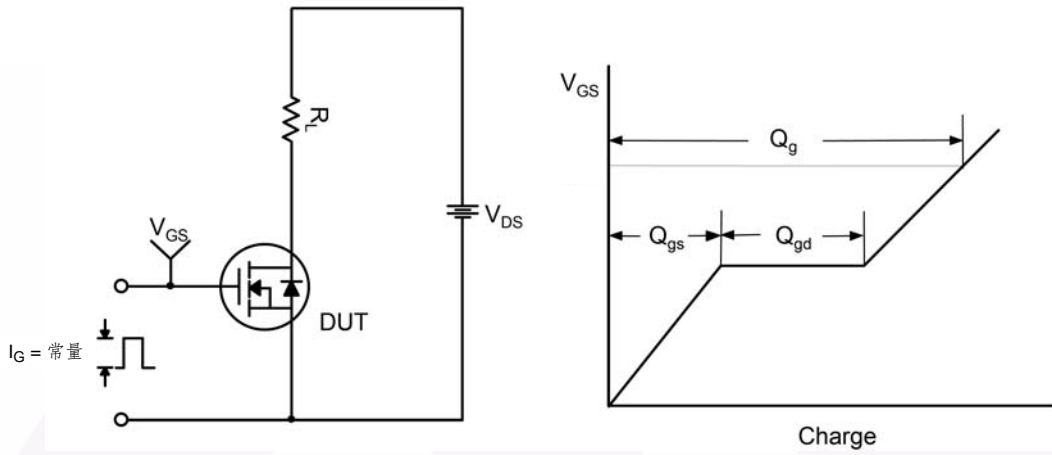

图 16. 非箝位感性开关测试电路与波形



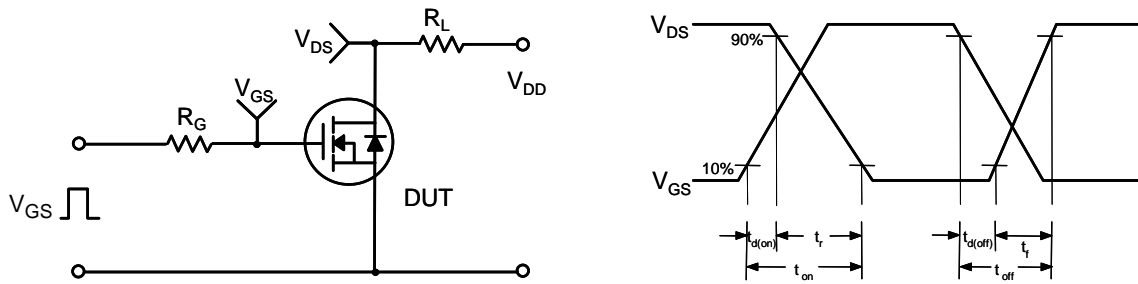

机械尺寸

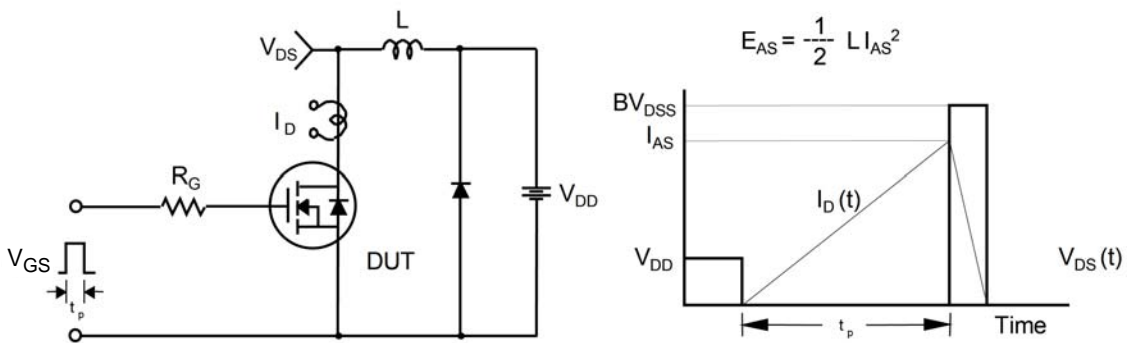

图 18. TO-220, 模塑, 3 引脚, Jedec 变体 AB

封装图纸作为一项服务, 提供给考虑飞兆半导体元件的客户。具体参数可能会有变化, 且不会做出相应通知。请注意图纸上的版本和 / 或日期, 并联系飞兆半导体代表核实或获得最新版本。封装规格并不超出飞兆公司全球范围内的条款与条件, 尤其指保修, 保修涵盖飞兆半导体的全部产品。

随时访问飞兆半导体在线封装网页, 可以获取最新的封装图纸:

[http://www.fairchildsemi.com/package/packageDetails.html?id=PN\\_TT220-003](http://www.fairchildsemi.com/package/packageDetails.html?id=PN_TT220-003)

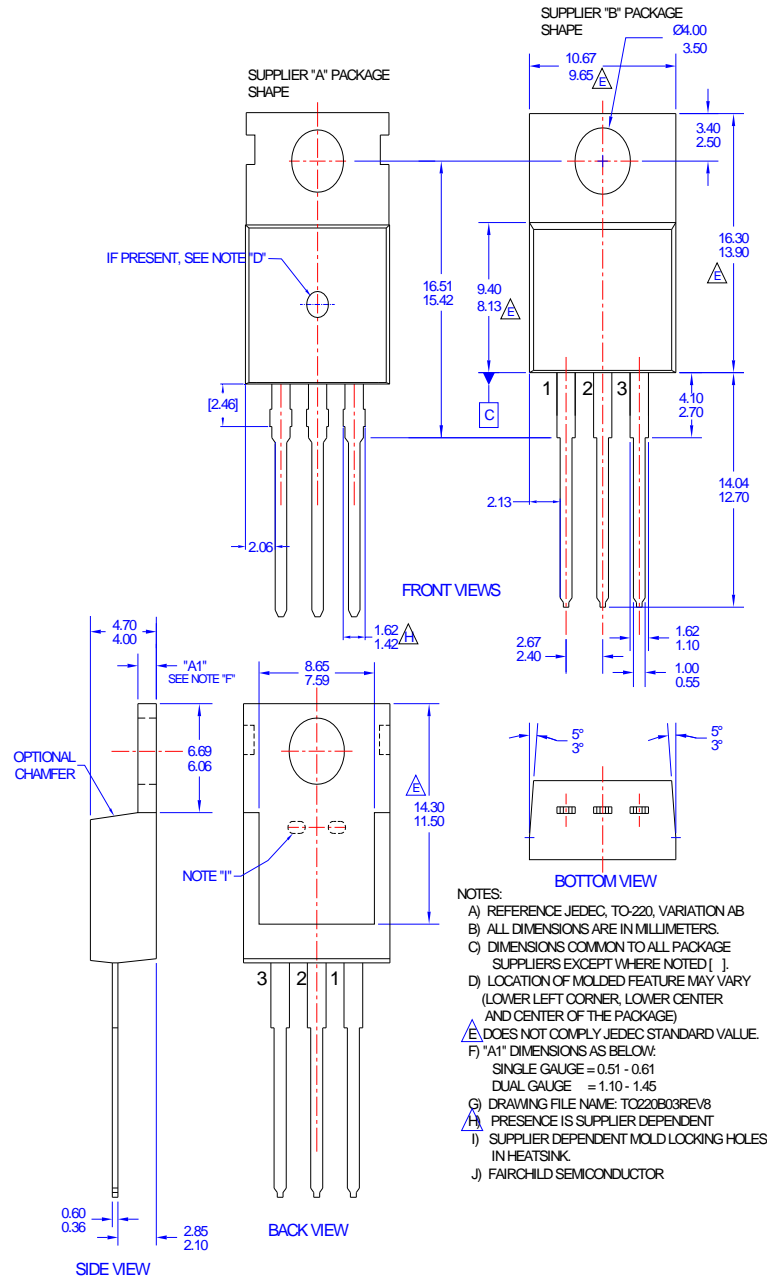



ON Semiconductor and  are trademarks of Semiconductor Components Industries, LLC dba ON Semiconductor or its subsidiaries in the United States and/or other countries. ON Semiconductor owns the rights to a number of patents, trademarks, copyrights, trade secrets, and other intellectual property. A listing of ON Semiconductor's product/patent coverage may be accessed at [www.onsemi.com/site/pdf/Patent-Marking.pdf](http://www.onsemi.com/site/pdf/Patent-Marking.pdf). ON Semiconductor reserves the right to make changes without further notice to any products herein. ON Semiconductor makes no warranty, representation or guarantee regarding the suitability of its products for any particular purpose, nor does ON Semiconductor assume any liability arising out of the application or use of any product or circuit, and specifically disclaims any and all liability, including without limitation special, consequential or incidental damages. Buyer is responsible for its products and applications using ON Semiconductor products, including compliance with all laws, regulations and safety requirements or standards, regardless of any support or applications information provided by ON Semiconductor. "Typical" parameters which may be provided in ON Semiconductor data sheets and/or specifications can and do vary in different applications and actual performance may vary over time. All operating parameters, including "Typicals" must be validated for each customer application by customer's technical experts. ON Semiconductor does not convey any license under its patent rights nor the rights of others. ON Semiconductor products are not designed, intended, or authorized for use as a critical component in life support systems or any FDA Class 3 medical devices or medical devices with a same or similar classification in a foreign jurisdiction or any devices intended for implantation in the human body. Should Buyer purchase or use ON Semiconductor products for any such unintended or unauthorized application, Buyer shall indemnify and hold ON Semiconductor and its officers, employees, subsidiaries, affiliates, and distributors harmless against all claims, costs, damages, and expenses, and reasonable attorney fees arising out of, directly or indirectly, any claim of personal injury or death associated with such unintended or unauthorized use, even if such claim alleges that ON Semiconductor was negligent regarding the design or manufacture of the part. ON Semiconductor is an Equal Opportunity/Affirmative Action Employer. This literature is subject to all applicable copyright laws and is not for resale in any manner.

## PUBLICATION ORDERING INFORMATION

### LITERATURE FULFILLMENT:

Literature Distribution Center for ON Semiconductor  
19521 E. 32nd Pkwy, Aurora, Colorado 80011 USA  
**Phone:** 303-675-2175 or 800-344-3860 Toll Free USA/Canada  
**Fax:** 303-675-2176 or 800-344-3867 Toll Free USA/Canada  
**Email:** [orderlit@onsemi.com](mailto:orderlit@onsemi.com)

**N. American Technical Support:** 800-282-9855 Toll Free  
USA/Canada  
**Europe, Middle East and Africa Technical Support:**  
Phone: 421 33 790 2910  
**Japan Customer Focus Center**  
Phone: 81-3-5817-1050

**ON Semiconductor Website:** [www.onsemi.com](http://www.onsemi.com)  
**Order Literature:** <http://www.onsemi.com/orderlit>  
For additional information, please contact your local  
Sales Representative