



Is Now Part of



ON Semiconductor®

To learn more about ON Semiconductor, please visit our website at
www.onsemi.com

Please note: As part of the Fairchild Semiconductor integration, some of the Fairchild orderable part numbers will need to change in order to meet ON Semiconductor's system requirements. Since the ON Semiconductor product management systems do not have the ability to manage part nomenclature that utilizes an underscore (_), the underscore (_) in the Fairchild part numbers will be changed to a dash (-). This document may contain device numbers with an underscore (_). Please check the ON Semiconductor website to verify the updated device numbers. The most current and up-to-date ordering information can be found at www.onsemi.com. Please email any questions regarding the system integration to Fairchild_questions@onsemi.com.

ON Semiconductor and the ON Semiconductor logo are trademarks of Semiconductor Components Industries, LLC dba ON Semiconductor or its subsidiaries in the United States and/or other countries. ON Semiconductor owns the rights to a number of patents, trademarks, copyrights, trade secrets, and other intellectual property. A listing of ON Semiconductor's product/patent coverage may be accessed at www.onsemi.com/site/pdf/Patent-Marking.pdf. ON Semiconductor reserves the right to make changes without further notice to any products herein. ON Semiconductor makes no warranty, representation or guarantee regarding the suitability of its products for any particular purpose, nor does ON Semiconductor assume any liability arising out of the application or use of any product or circuit, and specifically disclaims any and all liability, including without limitation special, consequential or incidental damages. Buyer is responsible for its products and applications using ON Semiconductor products, including compliance with all laws, regulations and safety requirements or standards, regardless of any support or applications information provided by ON Semiconductor. "Typical" parameters which may be provided in ON Semiconductor data sheets and/or specifications can and do vary in different applications and actual performance may vary over time. All operating parameters, including "Typicals" must be validated for each customer application by customer's technical experts. ON Semiconductor does not convey any license under its patent rights nor the rights of others. ON Semiconductor products are not designed, intended, or authorized for use as a critical component in life support systems or any FDA Class 3 medical devices or medical devices with a same or similar classification in a foreign jurisdiction or any devices intended for implantation in the human body. Should Buyer purchase or use ON Semiconductor products for any such unintended or unauthorized application, Buyer shall indemnify and hold ON Semiconductor and its officers, employees, subsidiaries, affiliates, and distributors harmless against all claims, costs, damages, and expenses, and reasonable attorney fees arising out of, directly or indirectly, any claim of personal injury or death associated with such unintended or unauthorized use, even if such claim alleges that ON Semiconductor was negligent regarding the design or manufacture of the part. ON Semiconductor is an Equal Opportunity/Affirmative Action Employer. This literature is subject to all applicable copyright laws and is not for resale in any manner.



April 2014



FDA8440

N-Channel Logic Level PowerTrench[®] MOSFET

40 V, 100 A, 2.1 mΩ

Features

- $R_{DS(on)} = 1.46 \text{ m}\Omega$ (Typ.) @ $V_{GS} = 10 \text{ V}$, $I_D = 80 \text{ A}$
- $Q_{G(tot)} = 345 \text{ nC}$ (Typ.) @ $V_{GS} = 10 \text{ V}$
- Low Miller Charge
- Low Q_{rr} Body Diode
- UIS Capability (Single Pulse and Repetitive Pulse)
- 160 A Guarantee for 2 sec
- RoHS Compliant

Application

- Power tools
- Motor drives and Uninterruptible Power Supplies
- Synchronous Rectification
- Battery Protection Circuit

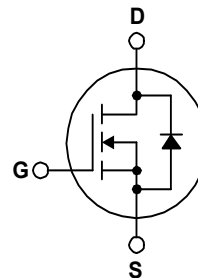
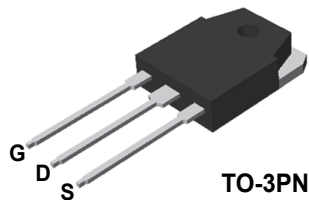

MOSFET Maximum Ratings $T_C = 25^\circ\text{C}$ unless otherwise noted.

Symbol	Parameter	FDA8440	Unit
V_{DSS}	Drain to Source Voltage	40	V
V_{GSS}	Gate to Source Voltage	± 20	V
I_D	Drain Current - Continuous ($T_C = 155^\circ\text{C}$)	100	A
	- Continuous ($T_A = 25^\circ\text{C}$, $V_{GS} = 10 \text{ V}$, $R_{\theta JA} = 40^\circ\text{C/W}$)	30	A
	- Pulsed	500	A
E_{AS}	Single Pulsed Avalanche Energy (Note 1)	1682	mJ
P_D	Power dissipation	306	W
	Derate above 25°C	2.04	W/ $^\circ\text{C}$
T_J, T_{STG}	Operating and Storage Temperature	-55 to +175	$^\circ\text{C}$

Thermal Characteristics

$R_{\theta JC}$	Thermal Resistance, Junction to Case, Max.	0.49	$^\circ\text{C/W}$
$R_{\theta JA}$	Thermal Resistance, Junction to Ambient, Max. (Note 2)	40	$^\circ\text{C/W}$

FDA8440 N-Channel Logic Level PowerTrench[®] MOSFET

Package Marking and Ordering Information

Part Number	Top Mark	Package	Packing Method	Reel Size	Tape Width	Quantity
FDA8440	FDA8440	TO-3PN	Tube	N/A	N/A	30 units

Electrical Characteristics T_C = 25°C unless otherwise noted

Symbol	Parameter	Conditions	Min.	Typ.	Max.	Unit
Off Characteristics						
BV _{DSS}	Drain to Source Breakdown Voltage	V _{GS} = 0 V, I _D = 250 μA	40	--	--	V
I _{DSS}	Zero Gate Voltage Drain Current	V _{DS} = 32 V	--	--	1	μA
		V _{GS} = 0 V, T _C = 150°C	--	--	250	μA
I _{GSS}	Gate to Body Leakage Current	V _{GS} = ±20 V	--	--	±100	nA
On Characteristics						
V _{GS(th)}	Gate to Source Threshold Voltage	V _{DS} = V _{GS} , I _D = 250 μA	1	--	3	V
R _{DS(on)}	Static Drain-Source On-Resistance	V _{GS} = 4.5 V, I _D = 80 A	--	1.56	2.2	mΩ
		V _{GS} = 10 V, I _D = 80 A	--	1.46	2.1	
		V _{GS} = 10 V, I _D = 80 A, T _C = 175°C	--	2.82	4.1	
Dynamic Characteristics						
C _{iss}	Input Capacitance	V _{DS} = 25 V, V _{GS} = 0 V, f = 1 MHz	--	18600	24740	pF
C _{oss}	Output Capacitance		--	1840	2450	pF
C _{rss}	Reverse Transfer Capacitance		--	1400	2100	pF
R _G	Gate Resistance	V _{GS} = 0.5 V, f = 1 MHz	--	1.1	--	Ω
Q _{g(tot)}	Total Gate Charge at 10V	V _{GS} = 0 V to 10 V	--	345	450	nC
Q _{g(2)}	Threshold Gate Charge	V _{GS} = 0 V to 2 V	--	32.5	--	nC
Q _{gs}	Gate to Source Gate Charge	V _{DD} = 20 V I _D = 80 A I _g = 1.0 mA	--	49	--	nC
Q _{gs2}	Gate Charge Threshold to Plateau		--	16.5	--	nC
Q _{gd}	Gate to Drain "Miller" Charge		--	74	--	nC
Switching Characteristics						
t _{ON}	Turn-On Time	V _{DD} = 20 V, I _D = 80 A V _{GS} = 10 V, R _{GEN} = 7 Ω	--	175	360	ns
t _{d(on)}	Turn-On Delay Time		--	43	95	ns
t _r	Rise Time		--	130	275	ns
t _{d(off)}	Turn-Off Delay Time		--	435	875	ns
t _f	Fall Time		--	290	590	ns
t _{OFF}	Turn-Off Time		--	730	1470	ns
Drain-Source Diode Characteristics and Maximum Ratings						
V _{SD}	Source to Drain Diode Voltage	I _{SD} = 80 A	--	--	1.25	V
		I _{SD} = 40 A	--	--	1.0	V
t _{rr}	Reverse Recovery Time	I _{SD} = 75 A, dI _{SD} /dt = 100 A/μs	--	59	--	ns
Q _{RR}	Reverse Recovery Charge	I _{SD} = 75 A, dI _{SD} /dt = 100 A/μs	--	77	--	nC

NOTES:

- Starting T_J = 25°C, L = 1 mH, I_{AS} = 58 A, V_{DD} = 36 V, V_{GS} = 10 V.
- Pulse width = 100 s.

Typical Performance Characteristics

Figure 1. On-Region Characteristics

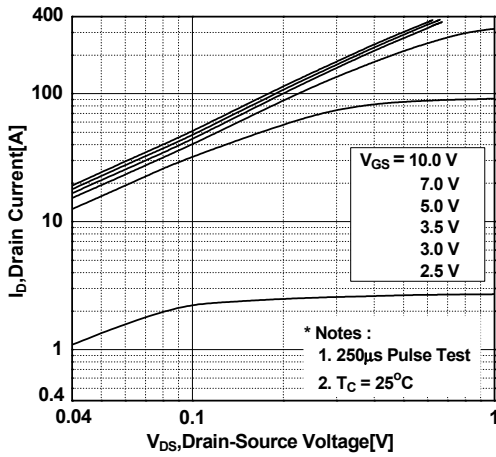

Figure 2. Transfer Characteristics

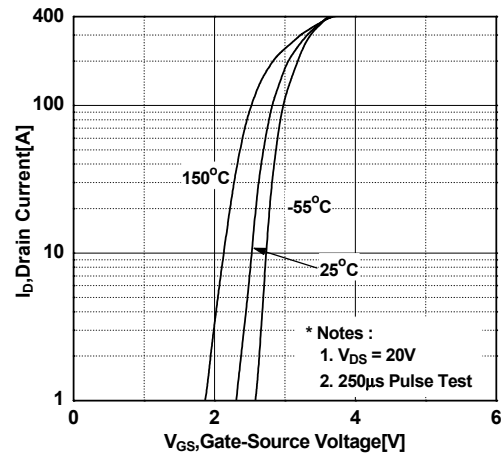

Figure 3. On-Resistance Variation vs. Drain Current and Gate Voltage

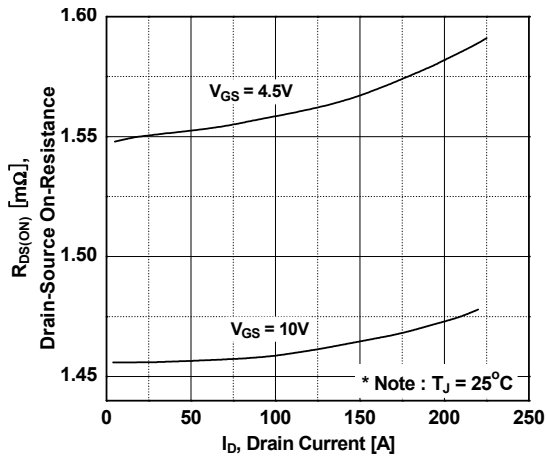

Figure 4. Body Diode Forward Voltage Variation vs. Source Current and Temperature

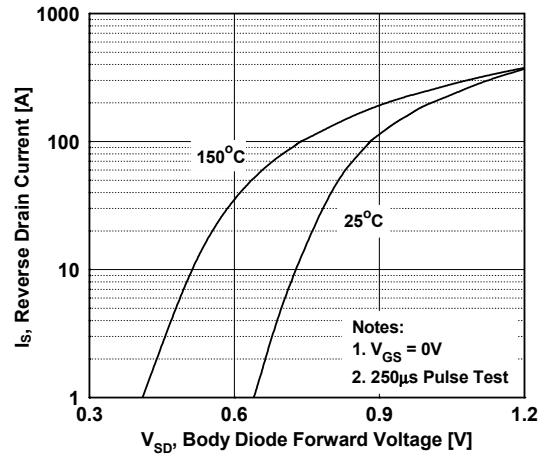

Figure 5. Capacitance Characteristics

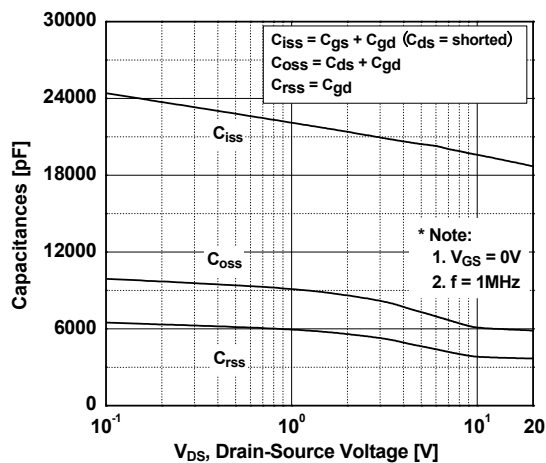
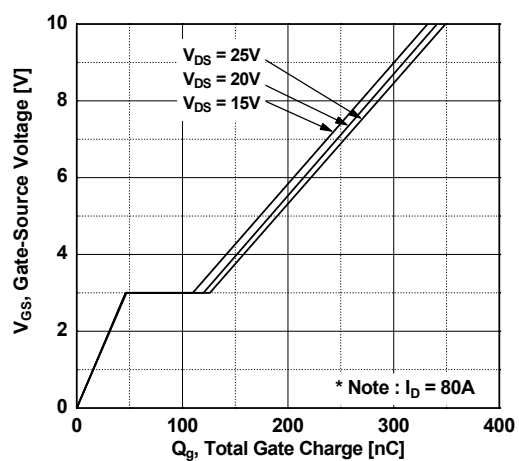

Figure 6. Gate Charge Characteristics



Typical Performance Characteristics (Continued)

Figure 7. Breakdown Voltage Variation vs. Temperature

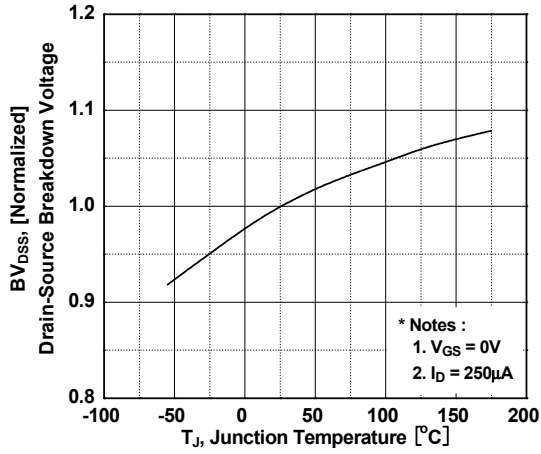

Figure 8. On-Resistance Variation vs. Temperature

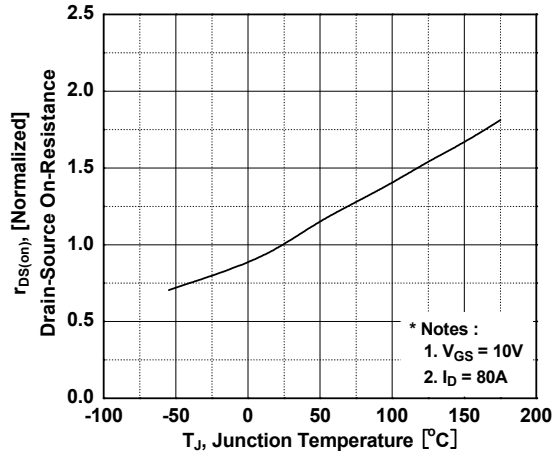

Figure 9. Unclamped Inductive Switching Capability

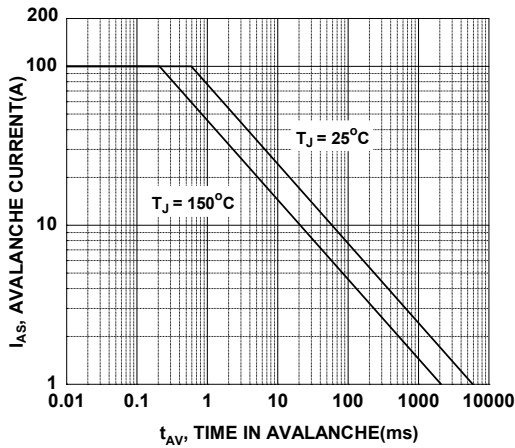

Figure 10. Safe Operating Area

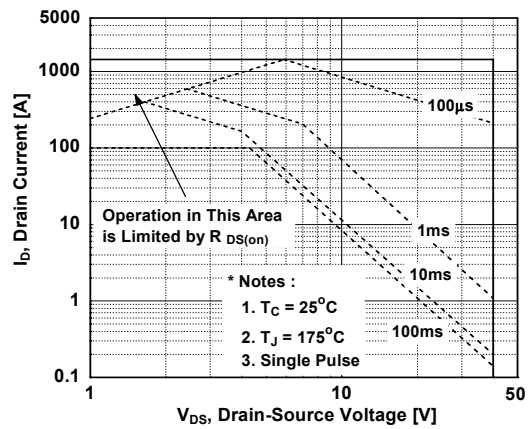
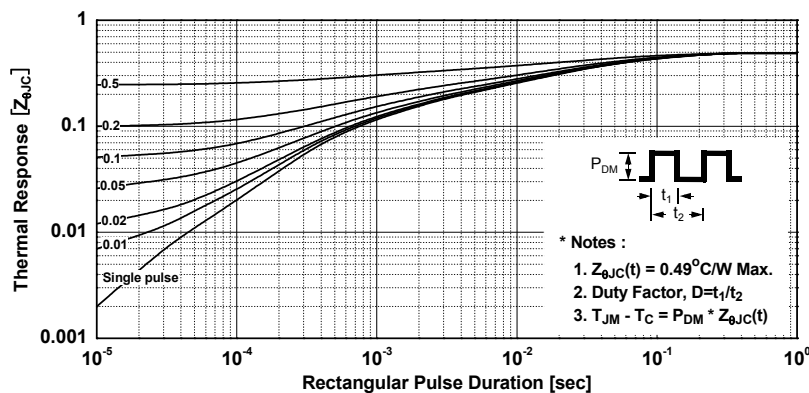

Figure 11. Transient Thermal Response Curve



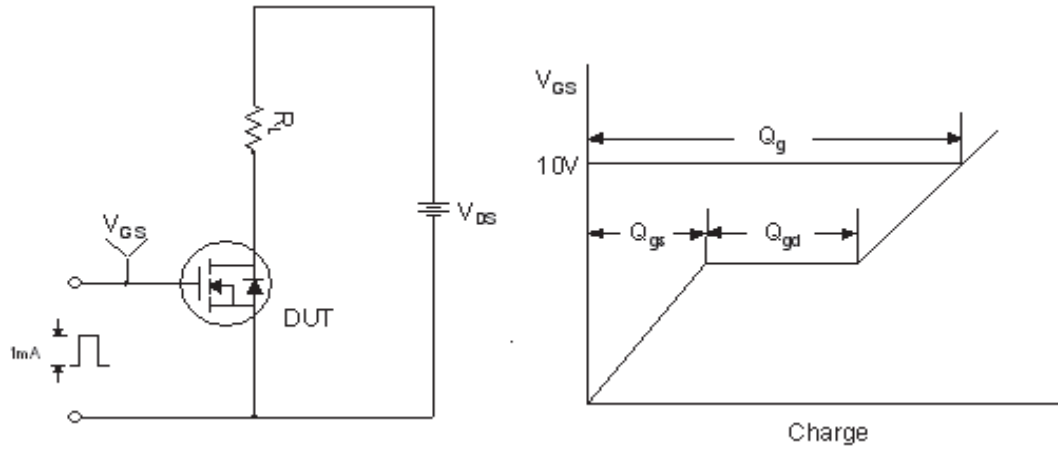

Figure 12. Gate Charge Test Circuit & Waveform

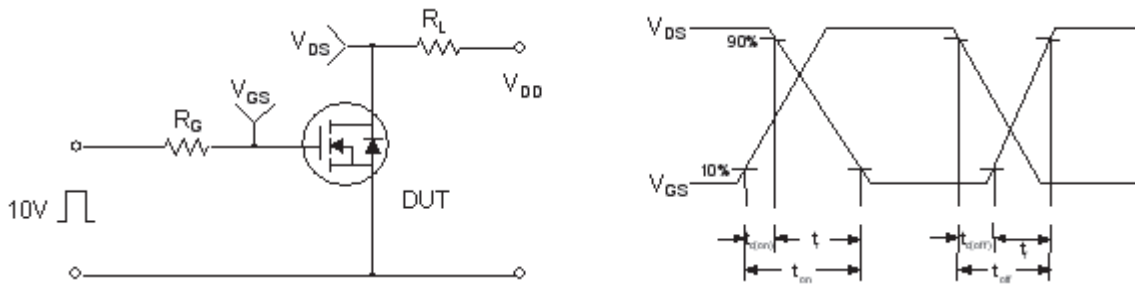

Figure 13. Resistive Switching Test Circuit & Waveforms

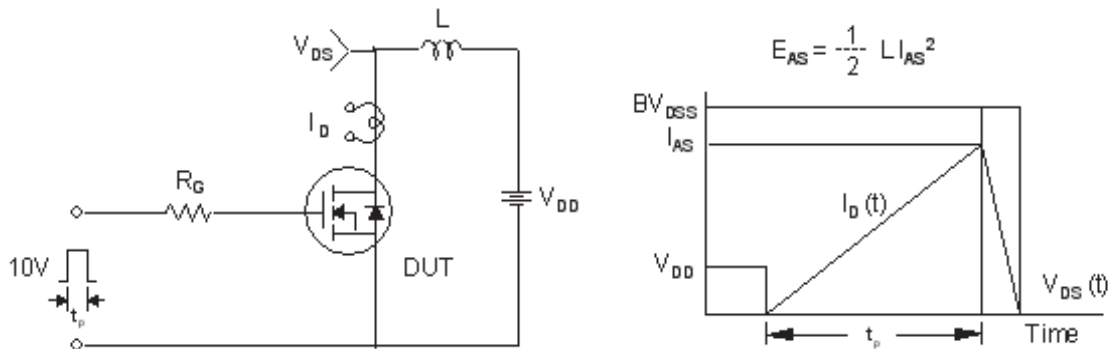

Figure 14. Unclamped Inductive Switching Test Circuit & Waveforms

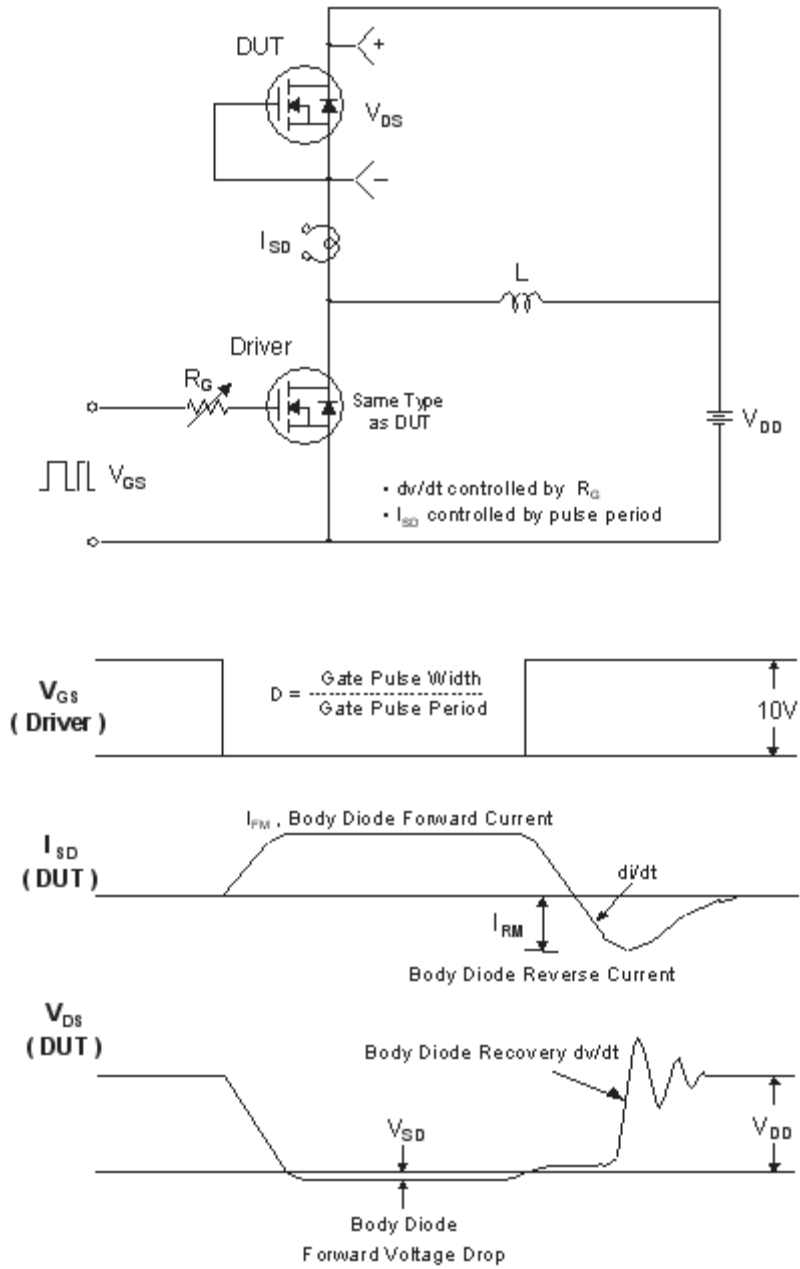
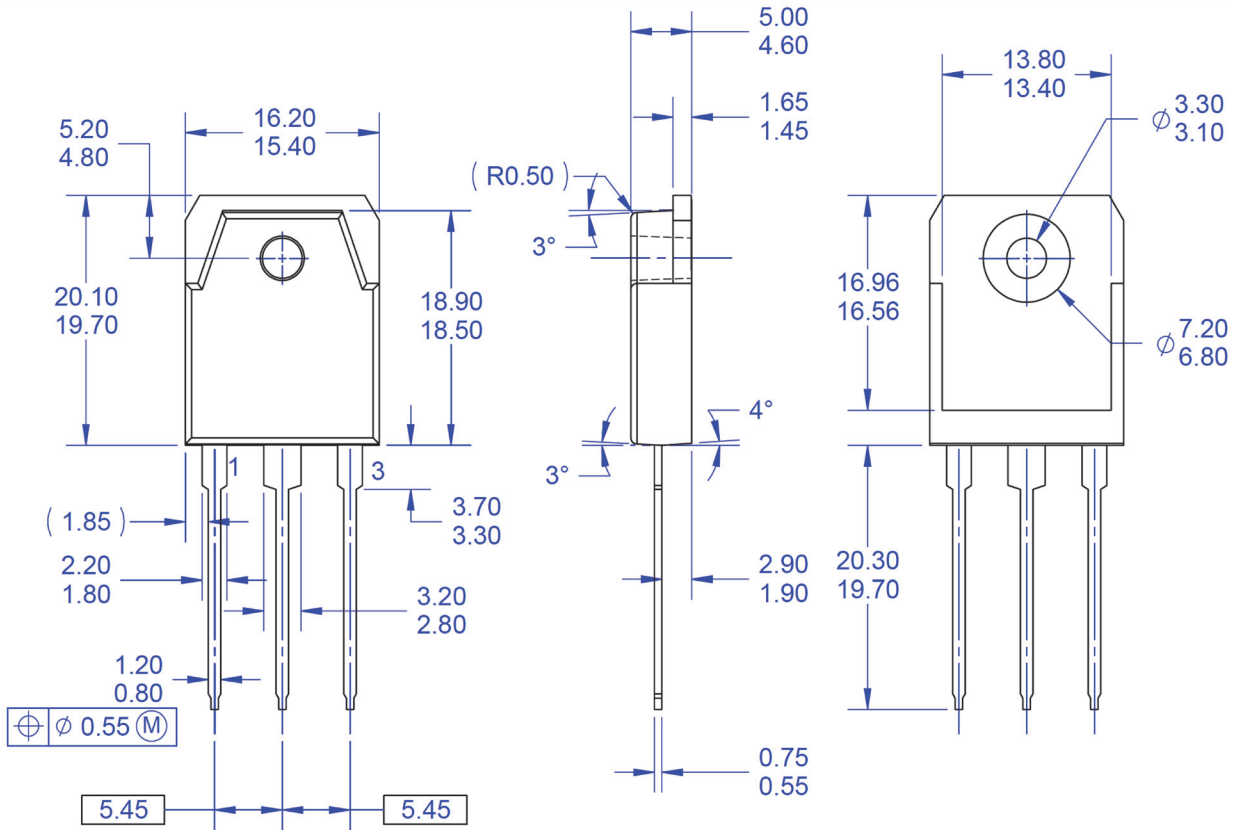

Figure 15. Peak Diode Recovery dv/dt Test Circuit & Waveforms

Mechanical Dimensions



NOTES: UNLESS OTHERWISE SPECIFIED

- THIS PACKAGE CONFORMS TO EIAJ SC-65 PACKAGING STANDARD.
- ALL DIMENSIONS ARE IN MILLIMETERS.
- DIMENSION AND TOLERANCING PER ASME14.5-2009.
- DIMENSIONS ARE EXCLUSIVE OF BURRS, MOLD FLASH, AND TIE BAR EXTRUSIONS.
- DRAWING FILE NAME: TO3PN03AREV1.
- FAIRCHILD SEMICONDUCTOR.

Figure 16. TO3PN, 3-Lead, Plastic, EIAJ SC-65

Package drawings are provided as a service to customers considering Fairchild components. Drawings may change in any manner without notice. Please note the revision and/or date on the drawing and contact a Fairchild Semiconductor representative to verify or obtain the most recent revision. Package specifications do not expand the terms of Fairchild's worldwide terms and conditions, specifically the warranty therein, which covers Fairchild products.

Always visit Fairchild Semiconductor's online packaging area for the most recent package drawings:

http://www.fairchildsemi.com/package/packageDetails.html?id=PN_TT3PN-003



TRADEMARKS

The following includes registered and unregistered trademarks and service marks, owned by Fairchild Semiconductor and/or its global subsidiaries, and is not intended to be an exhaustive list of all such trademarks.

- | | | | |
|---|---|-----------------------------|------------------|
| AccuPower™ | F-PFS™ | PowerTrench® | SYSTEM GENERAL® |
| AX-CAP®* | FRFET® | PowerXS™ | TinyBoost® |
| BitSiC™ | Global Power ResourceSM | Programmable Active Droop™ | TinyBuck® |
| Build it Now™ | GreenBridge™ | QFET® | TinyCalc™ |
| CorePLUS™ | Green FPS™ | QS™ | TinyLogic® |
| CorePOWER™ | Green FPS™ e-Series™ | Quiet Series™ | TINYOPTO™ |
| CROSSVOLT™ | Gmax™ | RapidConfigure™ | TinyPower™ |
| CTL™ | GTO™ | SmartMax™ | TinyPWM™ |
| Current Transfer Logic™ | IntelliMAX™ | SMART START™ | TinyWire™ |
| DEUXPEED® | ISOPLANAR™ | Solutions for Your Success™ | TranSiC™ |
| Dual Cool™ | Marking Small Speakers Sound Louder and Better™ | SPM® | TriFault Detect™ |
| EcoSPARK® | MegaBuck™ | STEALTH™ | TRUECURRENT®* |
| EfficientMax™ | MICROCOUPLER™ | SuperFET® | µSerDes™ |
| ESBC™ | MicroFET™ | SuperSOT™-3 | UHC® |
|  | MicroPak™ | SuperSOT™-6 | Ultra FRFET™ |
| Fairchild® | MicroPak2™ | SuperSOT™-8 | UniFET™ |
| Fairchild Semiconductor® | MillerDrive™ | SupreMOS® | VCX™ |
| FACT Quiet Series™ | MotionMax™ | SyncFET™ | VisualMax™ |
| FACT® | mWSaver® | Sync-Lock™ | VoltagePlus™ |
| FAST® | OptoHiT™ | | XS™ |
| FastvCore™ | OPTOLOGIC® | | ? ? ™ |
| FETBench™ | OPTOPLANAR® | | |
| FPS™ | | | |

*Trademarks of System General Corporation, used under license by Fairchild Semiconductor.

DISCLAIMER

FAIRCHILD SEMICONDUCTOR RESERVES THE RIGHT TO MAKE CHANGES WITHOUT FURTHER NOTICE TO ANY PRODUCTS HEREIN TO IMPROVE RELIABILITY, FUNCTION, OR DESIGN. FAIRCHILD DOES NOT ASSUME ANY LIABILITY ARISING OUT OF THE APPLICATION OR USE OF ANY PRODUCT OR CIRCUIT DESCRIBED HEREIN; NEITHER DOES IT CONVEY ANY LICENSE UNDER ITS PATENT RIGHTS, NOR THE RIGHTS OF OTHERS. THESE SPECIFICATIONS DO NOT EXPAND THE TERMS OF FAIRCHILD'S WORLDWIDE TERMS AND CONDITIONS, SPECIFICALLY THE WARRANTY THEREIN, WHICH COVERS THESE PRODUCTS.

LIFE SUPPORT POLICY

FAIRCHILD'S PRODUCTS ARE NOT AUTHORIZED FOR USE AS CRITICAL COMPONENTS IN LIFE SUPPORT DEVICES OR SYSTEMS WITHOUT THE EXPRESS WRITTEN APPROVAL OF FAIRCHILD SEMICONDUCTOR CORPORATION.

As used here in:

- Life support devices or systems are devices or systems which, (a) are intended for surgical implant into the body or (b) support or sustain life, and (c) whose failure to perform when properly used in accordance with instructions for use provided in the labeling, can be reasonably expected to result in a significant injury of the user.
- A critical component in any component of a life support, device, or system whose failure to perform can be reasonably expected to cause the failure of the life support device or system, or to affect its safety or effectiveness.

ANTI-COUNTERFEITING POLICY

Fairchild Semiconductor Corporation's Anti-Counterfeiting Policy. Fairchild's Anti-Counterfeiting Policy is also stated on our external website, www.fairchildsemi.com, under Sales Support.

Counterfeiting of semiconductor parts is a growing problem in the industry. All manufactures of semiconductor products are experiencing counterfeiting of their parts. Customers who inadvertently purchase counterfeit parts experience many problems such as loss of brand reputation, substandard performance, failed application, and increased cost of production and manufacturing delays. Fairchild is taking strong measures to protect ourselves and our customers from the proliferation of counterfeit parts. Fairchild strongly encourages customers to purchase Fairchild parts either directly from Fairchild or from Authorized Fairchild Distributors who are listed by country on our web page cited above. Products customers buy either from Fairchild directly or from Authorized Fairchild Distributors are genuine parts, have full traceability, meet Fairchild's quality standards for handling and storage and provide access to Fairchild's full range of up-to-date technical and product information. Fairchild and our Authorized Distributors will stand behind all warranties and will appropriately address and warranty issues that may arise. Fairchild will not provide any warranty coverage or other assistance for parts bought from Unauthorized Sources. Fairchild is committed to combat this global problem and encourage our customers to do their part in stopping this practice by buying direct or from authorized distributors.

PRODUCT STATUS DEFINITIONS

Definition of Terms

Datasheet Identification	Product Status	Definition
Advance Information	Formative / In Design	Datasheet contains the design specifications for product development. Specifications may change in any manner without notice.
Preliminary	First Production	Datasheet contains preliminary data; supplementary data will be published at a later date. Fairchild Semiconductor reserves the right to make changes at any time without notice to improve design.
No Identification Needed	Full Production	Datasheet contains final specifications. Fairchild Semiconductor reserves the right to make changes at any time without notice to improve the design.
Obsolete	Not In Production	Datasheet contains specifications on a product that is discontinued by Fairchild Semiconductor. The datasheet is for reference information only.

ON Semiconductor and  are trademarks of Semiconductor Components Industries, LLC dba ON Semiconductor or its subsidiaries in the United States and/or other countries. ON Semiconductor owns the rights to a number of patents, trademarks, copyrights, trade secrets, and other intellectual property. A listing of ON Semiconductor's product/patent coverage may be accessed at www.onsemi.com/site/pdf/Patent-Marking.pdf. ON Semiconductor reserves the right to make changes without further notice to any products herein. ON Semiconductor makes no warranty, representation or guarantee regarding the suitability of its products for any particular purpose, nor does ON Semiconductor assume any liability arising out of the application or use of any product or circuit, and specifically disclaims any and all liability, including without limitation special, consequential or incidental damages. Buyer is responsible for its products and applications using ON Semiconductor products, including compliance with all laws, regulations and safety requirements or standards, regardless of any support or applications information provided by ON Semiconductor. "Typical" parameters which may be provided in ON Semiconductor data sheets and/or specifications can and do vary in different applications and actual performance may vary over time. All operating parameters, including "Typicals" must be validated for each customer application by customer's technical experts. ON Semiconductor does not convey any license under its patent rights nor the rights of others. ON Semiconductor products are not designed, intended, or authorized for use as a critical component in life support systems or any FDA Class 3 medical devices or medical devices with a same or similar classification in a foreign jurisdiction or any devices intended for implantation in the human body. Should Buyer purchase or use ON Semiconductor products for any such unintended or unauthorized application, Buyer shall indemnify and hold ON Semiconductor and its officers, employees, subsidiaries, affiliates, and distributors harmless against all claims, costs, damages, and expenses, and reasonable attorney fees arising out of, directly or indirectly, any claim of personal injury or death associated with such unintended or unauthorized use, even if such claim alleges that ON Semiconductor was negligent regarding the design or manufacture of the part. ON Semiconductor is an Equal Opportunity/Affirmative Action Employer. This literature is subject to all applicable copyright laws and is not for resale in any manner.

PUBLICATION ORDERING INFORMATION

LITERATURE FULFILLMENT:

Literature Distribution Center for ON Semiconductor
19521 E. 32nd Pkwy, Aurora, Colorado 80011 USA
Phone: 303-675-2175 or 800-344-3860 Toll Free USA/Canada
Fax: 303-675-2176 or 800-344-3867 Toll Free USA/Canada
Email: orderlit@onsemi.com

N. American Technical Support: 800-282-9855 Toll Free
USA/Canada
Europe, Middle East and Africa Technical Support:
Phone: 421 33 790 2910
Japan Customer Focus Center
Phone: 81-3-5817-1050

ON Semiconductor Website: www.onsemi.com
Order Literature: <http://www.onsemi.com/orderlit>
For additional information, please contact your local
Sales Representative