



Is Now Part of



ON Semiconductor®

To learn more about ON Semiconductor, please visit our website at
www.onsemi.com

Please note: As part of the Fairchild Semiconductor integration, some of the Fairchild orderable part numbers will need to change in order to meet ON Semiconductor's system requirements. Since the ON Semiconductor product management systems do not have the ability to manage part nomenclature that utilizes an underscore (_), the underscore (_) in the Fairchild part numbers will be changed to a dash (-). This document may contain device numbers with an underscore (_). Please check the ON Semiconductor website to verify the updated device numbers. The most current and up-to-date ordering information can be found at www.onsemi.com. Please email any questions regarding the system integration to Fairchild_questions@onsemi.com.

ON Semiconductor and the ON Semiconductor logo are trademarks of Semiconductor Components Industries, LLC dba ON Semiconductor or its subsidiaries in the United States and/or other countries. ON Semiconductor owns the rights to a number of patents, trademarks, copyrights, trade secrets, and other intellectual property. A listing of ON Semiconductor's product/patent coverage may be accessed at www.onsemi.com/site/pdf/Patent-Marking.pdf. ON Semiconductor reserves the right to make changes without further notice to any products herein. ON Semiconductor makes no warranty, representation or guarantee regarding the suitability of its products for any particular purpose, nor does ON Semiconductor assume any liability arising out of the application or use of any product or circuit, and specifically disclaims any and all liability, including without limitation special, consequential or incidental damages. Buyer is responsible for its products and applications using ON Semiconductor products, including compliance with all laws, regulations and safety requirements or standards, regardless of any support or applications information provided by ON Semiconductor. "Typical" parameters which may be provided in ON Semiconductor data sheets and/or specifications can and do vary in different applications and actual performance may vary over time. All operating parameters, including "Typicals" must be validated for each customer application by customer's technical experts. ON Semiconductor does not convey any license under its patent rights nor the rights of others. ON Semiconductor products are not designed, intended, or authorized for use as a critical component in life support systems or any FDA Class 3 medical devices or medical devices with a same or similar classification in a foreign jurisdiction or any devices intended for implantation in the human body. Should Buyer purchase or use ON Semiconductor products for any such unintended or unauthorized application, Buyer shall indemnify and hold ON Semiconductor and its officers, employees, subsidiaries, affiliates, and distributors harmless against all claims, costs, damages, and expenses, and reasonable attorney fees arising out of, directly or indirectly, any claim of personal injury or death associated with such unintended or unauthorized use, even if such claim alleges that ON Semiconductor was negligent regarding the design or manufacture of the part. ON Semiconductor is an Equal Opportunity/Affirmative Action Employer. This literature is subject to all applicable copyright laws and is not for resale in any manner.



April 2015

FDBL0210N80

N-Channel PowerTrench[®] MOSFET

80 V, 240 A, 2.0 mΩ

Features

- Typical $R_{DS(on)}$ = 1.5 mΩ at $V_{GS} = 10V$, $I_D = 80 A$
- Typical $Q_{g(tot)}$ = 130 nC at $V_{GS} = 10V$, $I_D = 80 A$
- UIS Capability
- RoHS Compliant

Applications

- Industrial Motor Drive
- Industrial Power Supply
- Industrial Automations
- Battery Operated tools
- Battery Protection
- Solar Inverters
- UPS and Energy Inverters
- Energy Storage
- Load Switch

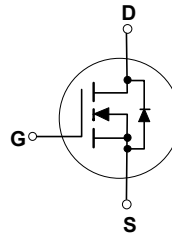
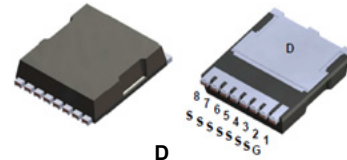

For current package drawing, please refer to the Fairchild website at <http://www.fairchildsemi.com/dwg/PS/PSOF08A.pdf>.

MOSFET Maximum Ratings $T_J = 25^\circ C$ unless otherwise noted.

Symbol	Parameter	Rated	Units
V_{DSS}	Drain-to-Source Voltage	80	V
V_{GS}	Gate-to-Source Voltage	±20	V
I_D	Drain Current - Continuous ($V_{GS}=10$) (Note 1)	$T_C = 25^\circ C$	240
	Pulsed Drain Current	$T_C = 25^\circ C$	See Figure 4
E_{AS}	Single Pulse Avalanche Energy (Note 2)	512	mJ
P_D	Power Dissipation	357	W
	Derate Above $25^\circ C$	2.38	W/ $^\circ C$
T_J, T_{STG}	Operating and Storage Temperature	-55 to + 175	$^\circ C$
$R_{\theta JC}$	Thermal Resistance, Junction to Case	0.42	$^\circ C/W$
$R_{\theta JA}$	Maximum Thermal Resistance, Junction to Ambient (Note 3)	43	$^\circ C/W$

Notes:

- 1: Current is limited by silicon.
- 2: Starting $T_J = 25^\circ C$, $L = 0.25mH$, $I_{AS} = 64A$, $V_{DD} = 80V$ during inductor charging and $V_{DD} = 0V$ during time in avalanche.
- 3: $R_{\theta JA}$ is the sum of the junction-to-case and case-to-ambient thermal resistance, where the case thermal reference is defined as the solder mounting surface of the drain pins. $R_{\theta JC}$ is guaranteed by design, while $R_{\theta JA}$ is determined by the board design. The maximum rating presented here is based on mounting on a 1 in² pad of 2oz copper.

Package Marking and Ordering Information

Device Marking	Device	Package	Reel Size	Tape Width	Quantity
FDBL0210N80	FDBL0210N80	MO-299A	-	-	-

FDBL0210N80 N-Channel PowerTrench[®] MOSFET

Electrical Characteristics $T_J = 25^\circ\text{C}$ unless otherwise noted.

Symbol	Parameter	Test Conditions	Min.	Typ.	Max.	Units
--------	-----------	-----------------	------	------	------	-------

Off Characteristics

$B_{V_{DS}}$	Drain-to-Source Breakdown Voltage	$I_D = 250\mu\text{A}, V_{GS} = 0\text{V}$	80	-	-	V
I_{DSS}	Drain-to-Source Leakage Current	$V_{DS} = 80\text{V}, T_J = 25^\circ\text{C}$	-	-	1	μA
		$V_{GS} = 0\text{V}, T_J = 175^\circ\text{C}$ (Note 4)	-	-	1	mA
I_{GSS}	Gate-to-Source Leakage Current	$V_{GS} = \pm 20\text{V}$	-	-	± 100	nA

On Characteristics

$V_{GS(th)}$	Gate to Source Threshold Voltage	$V_{GS} = V_{DS}, I_D = 250\mu\text{A}$	2.0	3.0	4.0	V
$R_{DS(on)}$	Drain to Source On Resistance	$I_D = 80\text{A}, T_J = 25^\circ\text{C}$	-	1.5	2.0	m Ω
		$V_{GS} = 10\text{V}, T_J = 175^\circ\text{C}$ (Note 4)	-	3.1	4.1	m Ω

Dynamic Characteristics

C_{iss}	Input Capacitance	$V_{DS} = 40\text{V}, V_{GS} = 0\text{V}, f = 1\text{MHz}$	-	10000	-	pF
C_{oss}	Output Capacitance		-	1540	-	pF
C_{riss}	Reverse Transfer Capacitance		-	70	-	pF
R_g	Gate Resistance	$f = 1\text{MHz}$	-	2.8	-	Ω
$Q_{g(ToT)}$	Total Gate Charge at 10V	$V_{GS} = 0$ to 10V	-	130	169	nC
$Q_{g(th)}$	Threshold Gate Charge	$V_{GS} = 0$ to 2V				
Q_{gs}	Gate-to-Source Gate Charge	$V_{DD} = 64\text{V}, I_D = 80\text{A}$	-	47	-	nC
Q_{gd}	Gate-to-Drain "Miller" Charge		-	24	-	nC

Switching Characteristics

t_{on}	Turn-On Time	$V_{DD} = 40\text{V}, I_D = 80\text{A}, V_{GS} = 10\text{V}, R_{GEN} = 6\Omega$	-	-	133	ns
$t_{d(on)}$	Turn-On Delay		-	39	-	ns
t_r	Rise Time		-	63	-	ns
$t_{d(off)}$	Turn-Off Delay		-	61	-	ns
t_f	Fall Time		-	33	-	ns
t_{off}	Turn-Off Time		-	-	140	ns

Drain-Source Diode Characteristics

V_{SD}	Source-to-Drain Diode Voltage	$I_{SD} = 80\text{A}, V_{GS} = 0\text{V}$	-	-	1.25	V
		$I_{SD} = 40\text{A}, V_{GS} = 0\text{V}$	-	-	1.2	V
t_{rr}	Reverse-Recovery Time	$I_F = 80\text{A}, dI_{SD}/dt = 100\text{A}/\mu\text{s}$	-	83	108	ns
Q_{rr}	Reverse-Recovery Charge	$V_{DD} = 64\text{V}$	-	118	153	nC

Note:

4: The maximum value is specified by design at $T_J = 175^\circ\text{C}$. Product is not tested to this condition in production.

Typical Characteristics

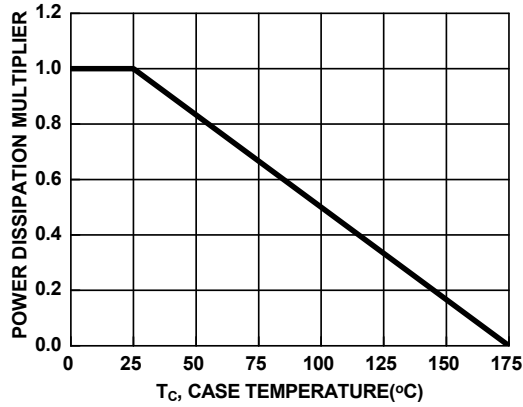

Figure 1. Normalized Power Dissipation vs. Case Temperature

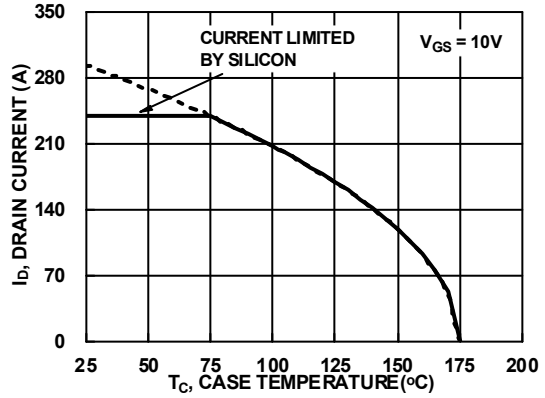

Figure 2. Maximum Continuous Drain Current vs. Case Temperature

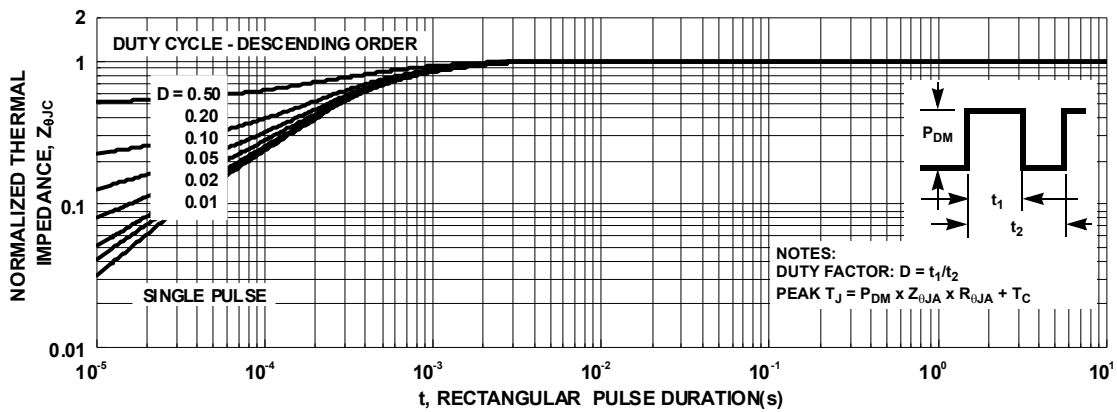

Figure 3. Normalized Maximum Transient Thermal Impedance

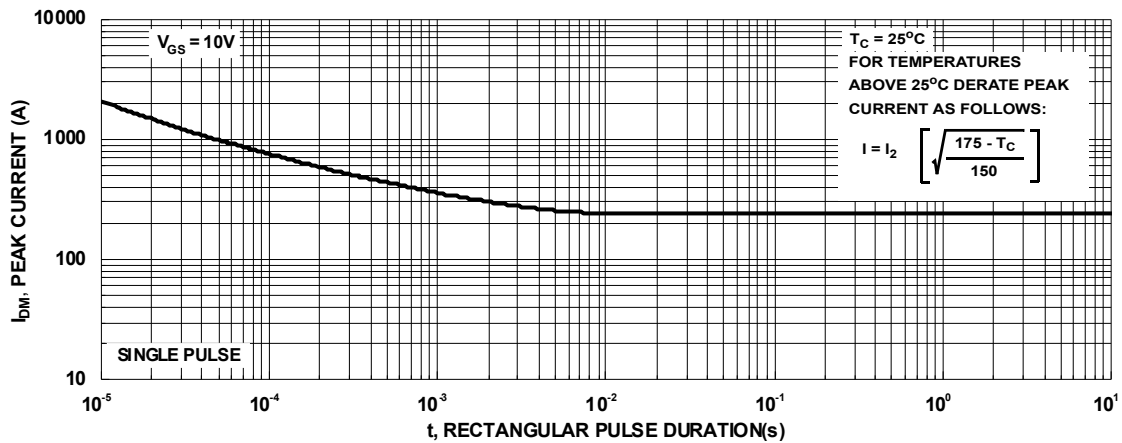

Figure 4. Peak Current Capability

Typical Characteristics

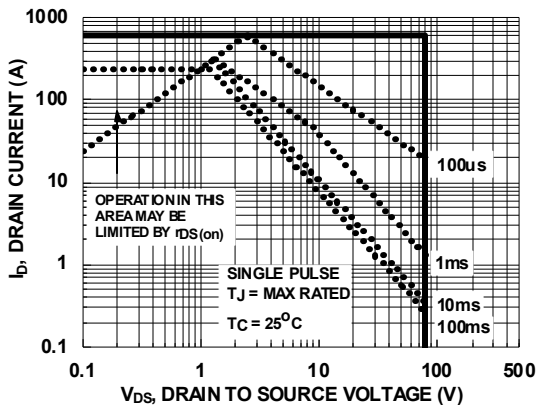
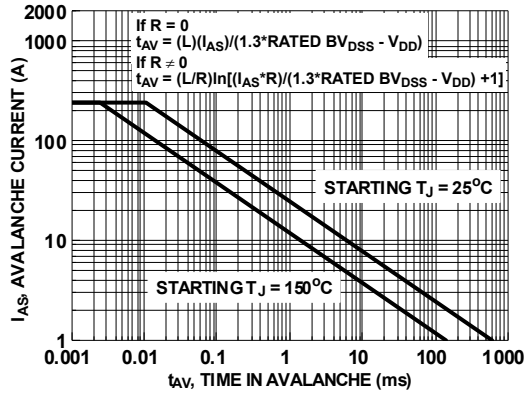

Figure 5. Forward Bias Safe Operating Area



NOTE: Refer to Fairchild Application Notes AN7514 and AN7515

Figure 6. Unclamped Inductive Switching Capability

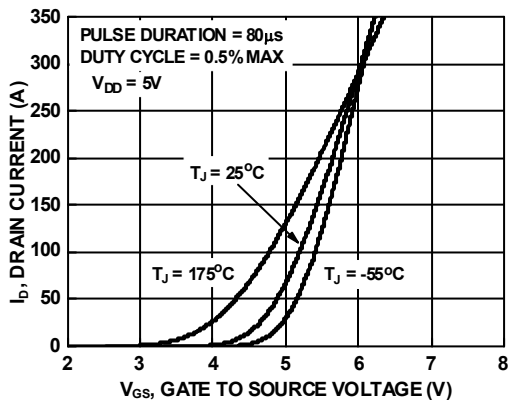

Figure 7. Transfer Characteristics

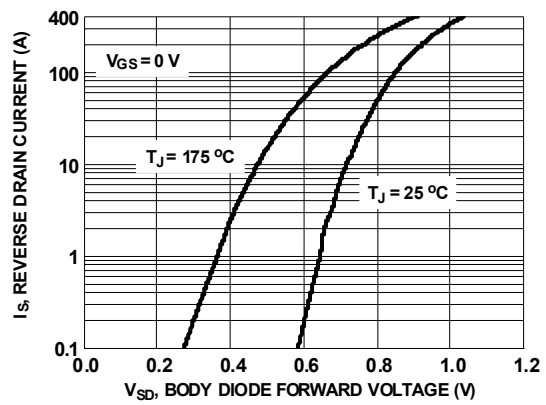

Figure 8. Forward Diode Characteristics

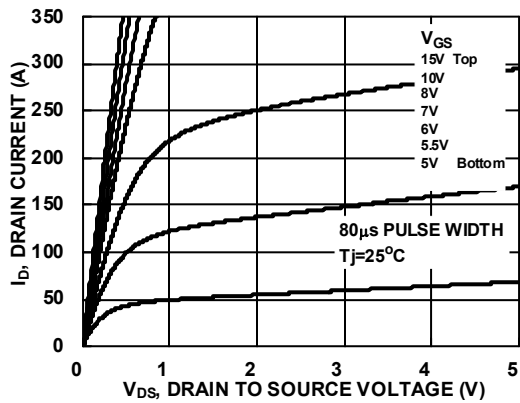

Figure 9. Saturation Characteristics

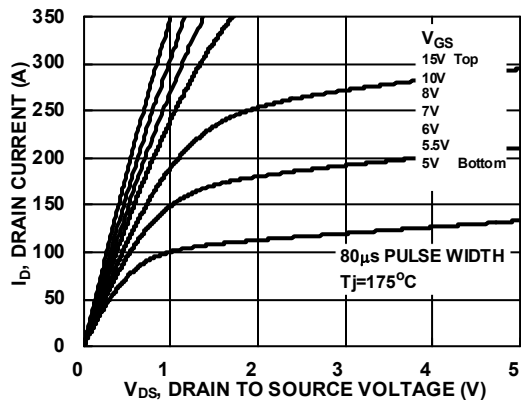

Figure 10. Saturation Characteristics

Typical Characteristics

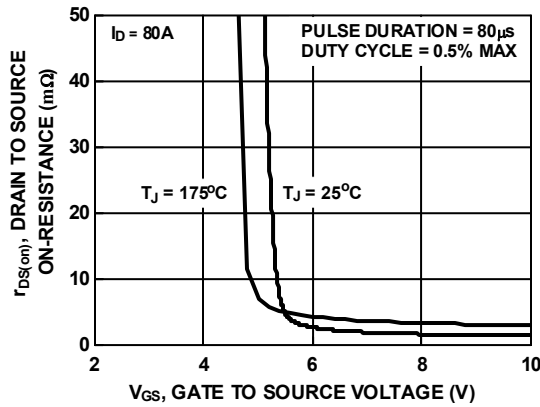

Figure 11. $R_{DS(on)}$ vs. Gate Voltage

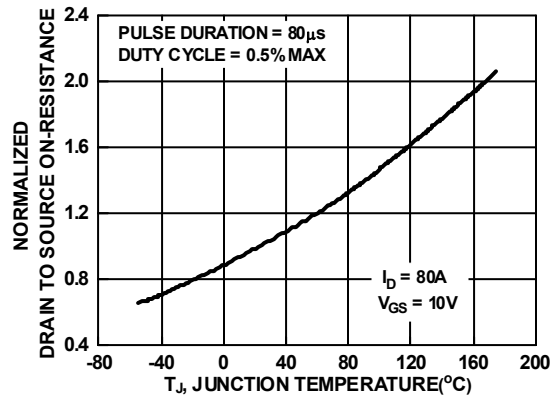

Figure 12. Normalized $R_{DS(on)}$ vs. Junction Temperature

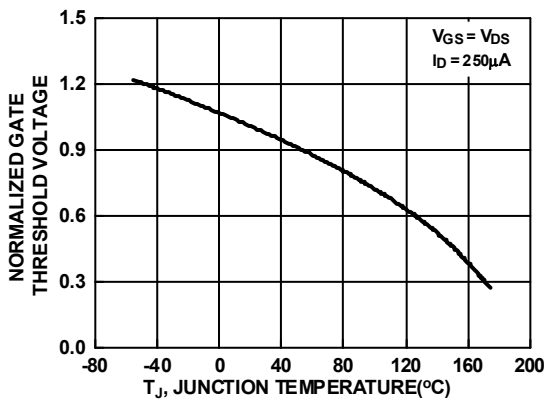

Figure 13. Normalized Gate Threshold Voltage vs. Temperature

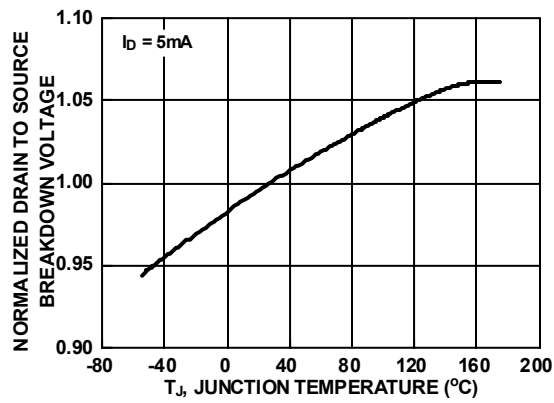

Figure 14. Normalized Drain to Source Breakdown Voltage vs. Junction Temperature

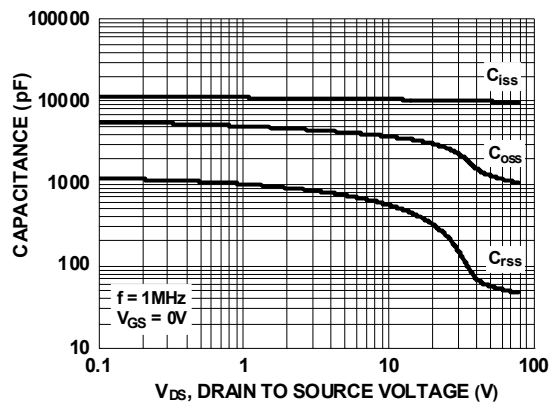

Figure 15. Capacitance vs. Drain to Source Voltage

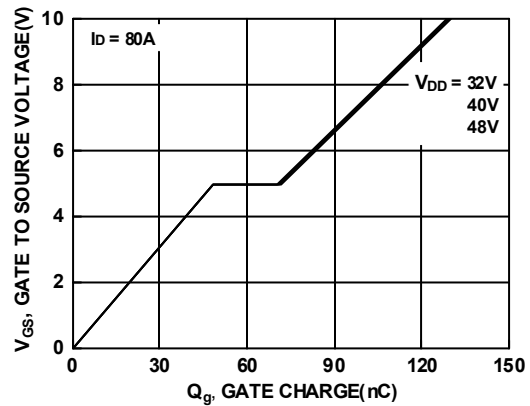
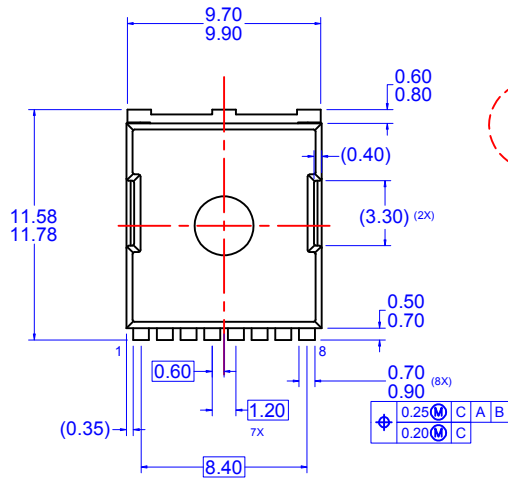
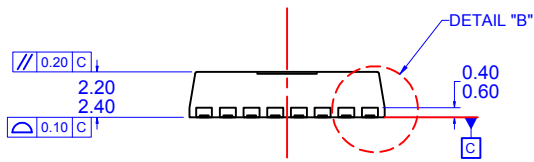
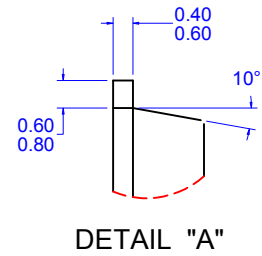
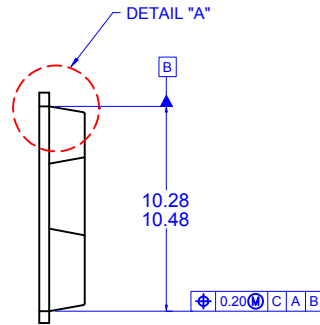

Figure 16. Gate Charge vs. Gate to Source Voltage



TOP VIEW



SIDE VIEW

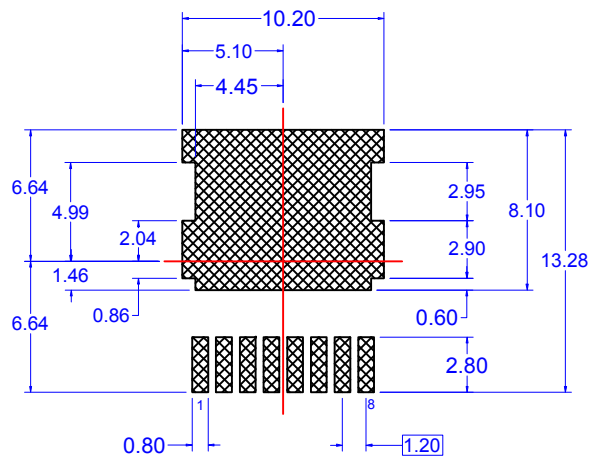

LAND PATTERN RECOMMENDATION

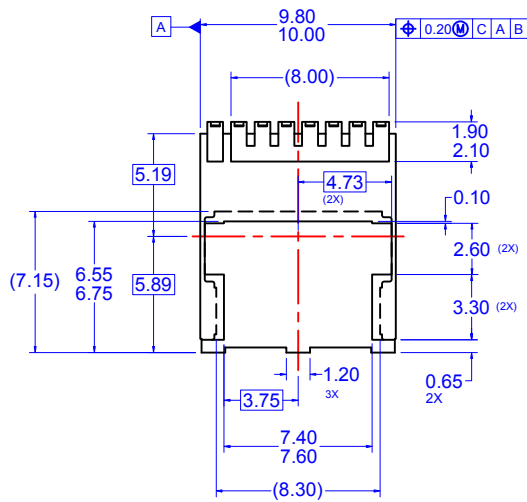

BOTTOM VIEW

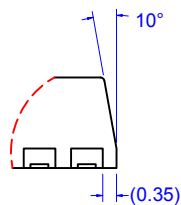

DETAIL "B"

- NOTES: UNLESS OTHERWISE SPECIFIED
- A) PACKAGE STANDARD REFERENCE: JEDEC MO-299, ISSUE A, DATED NOVEMBER 2009.
 - B) ALL DIMENSIONS ARE IN MILLIMETERS.
 - C) DIMENSIONS DO NOT INCLUDE BURRS OR MOLD FLASH. MOLD FLASH OR BURRS DOES NOT EXCEED 0.10MM.
 - D) DIMENSIONING AND TOLERANCING PER ASME Y14.5M-1994.
 - E) DRAWING FILE NAME: MKT-PSOF08AREV3

ON Semiconductor and  are trademarks of Semiconductor Components Industries, LLC dba ON Semiconductor or its subsidiaries in the United States and/or other countries. ON Semiconductor owns the rights to a number of patents, trademarks, copyrights, trade secrets, and other intellectual property. A listing of ON Semiconductor's product/patent coverage may be accessed at www.onsemi.com/site/pdf/Patent-Marking.pdf. ON Semiconductor reserves the right to make changes without further notice to any products herein. ON Semiconductor makes no warranty, representation or guarantee regarding the suitability of its products for any particular purpose, nor does ON Semiconductor assume any liability arising out of the application or use of any product or circuit, and specifically disclaims any and all liability, including without limitation special, consequential or incidental damages. Buyer is responsible for its products and applications using ON Semiconductor products, including compliance with all laws, regulations and safety requirements or standards, regardless of any support or applications information provided by ON Semiconductor. "Typical" parameters which may be provided in ON Semiconductor data sheets and/or specifications can and do vary in different applications and actual performance may vary over time. All operating parameters, including "Typicals" must be validated for each customer application by customer's technical experts. ON Semiconductor does not convey any license under its patent rights nor the rights of others. ON Semiconductor products are not designed, intended, or authorized for use as a critical component in life support systems or any FDA Class 3 medical devices or medical devices with a same or similar classification in a foreign jurisdiction or any devices intended for implantation in the human body. Should Buyer purchase or use ON Semiconductor products for any such unintended or unauthorized application, Buyer shall indemnify and hold ON Semiconductor and its officers, employees, subsidiaries, affiliates, and distributors harmless against all claims, costs, damages, and expenses, and reasonable attorney fees arising out of, directly or indirectly, any claim of personal injury or death associated with such unintended or unauthorized use, even if such claim alleges that ON Semiconductor was negligent regarding the design or manufacture of the part. ON Semiconductor is an Equal Opportunity/Affirmative Action Employer. This literature is subject to all applicable copyright laws and is not for resale in any manner.

PUBLICATION ORDERING INFORMATION

LITERATURE FULFILLMENT:

Literature Distribution Center for ON Semiconductor
19521 E. 32nd Pkwy, Aurora, Colorado 80011 USA
Phone: 303-675-2175 or 800-344-3860 Toll Free USA/Canada
Fax: 303-675-2176 or 800-344-3867 Toll Free USA/Canada
Email: orderlit@onsemi.com

N. American Technical Support: 800-282-9855 Toll Free
USA/Canada
Europe, Middle East and Africa Technical Support:
Phone: 421 33 790 2910
Japan Customer Focus Center
Phone: 81-3-5817-1050

ON Semiconductor Website: www.onsemi.com
Order Literature: <http://www.onsemi.com/orderlit>
For additional information, please contact your local
Sales Representative