



Is Now Part of



ON Semiconductor®

To learn more about ON Semiconductor, please visit our website at
www.onsemi.com

Please note: As part of the Fairchild Semiconductor integration, some of the Fairchild orderable part numbers will need to change in order to meet ON Semiconductor's system requirements. Since the ON Semiconductor product management systems do not have the ability to manage part nomenclature that utilizes an underscore (_), the underscore (_) in the Fairchild part numbers will be changed to a dash (-). This document may contain device numbers with an underscore (_). Please check the ON Semiconductor website to verify the updated device numbers. The most current and up-to-date ordering information can be found at www.onsemi.com. Please email any questions regarding the system integration to Fairchild_questions@onsemi.com.

ON Semiconductor and the ON Semiconductor logo are trademarks of Semiconductor Components Industries, LLC dba ON Semiconductor or its subsidiaries in the United States and/or other countries. ON Semiconductor owns the rights to a number of patents, trademarks, copyrights, trade secrets, and other intellectual property. A listing of ON Semiconductor's product/patent coverage may be accessed at www.onsemi.com/site/pdf/Patent-Marking.pdf. ON Semiconductor reserves the right to make changes without further notice to any products herein. ON Semiconductor makes no warranty, representation or guarantee regarding the suitability of its products for any particular purpose, nor does ON Semiconductor assume any liability arising out of the application or use of any product or circuit, and specifically disclaims any and all liability, including without limitation special, consequential or incidental damages. Buyer is responsible for its products and applications using ON Semiconductor products, including compliance with all laws, regulations and safety requirements or standards, regardless of any support or applications information provided by ON Semiconductor. "Typical" parameters which may be provided in ON Semiconductor data sheets and/or specifications can and do vary in different applications and actual performance may vary over time. All operating parameters, including "Typicals" must be validated for each customer application by customer's technical experts. ON Semiconductor does not convey any license under its patent rights nor the rights of others. ON Semiconductor products are not designed, intended, or authorized for use as a critical component in life support systems or any FDA Class 3 medical devices or medical devices with a same or similar classification in a foreign jurisdiction or any devices intended for implantation in the human body. Should Buyer purchase or use ON Semiconductor products for any such unintended or unauthorized application, Buyer shall indemnify and hold ON Semiconductor and its officers, employees, subsidiaries, affiliates, and distributors harmless against all claims, costs, damages, and expenses, and reasonable attorney fees arising out of, directly or indirectly, any claim of personal injury or death associated with such unintended or unauthorized use, even if such claim alleges that ON Semiconductor was negligent regarding the design or manufacture of the part. ON Semiconductor is an Equal Opportunity/Affirmative Action Employer. This literature is subject to all applicable copyright laws and is not for resale in any manner.



2015 年 5 月

FDD390N15A

N 沟道 PowerTrench[®] MOSFET

150 V, 26 A, 40 mΩ

特性

- $R_{DS(on)} = 33.5 \text{ m}\Omega$ (典型值) @ $V_{GS} = 10 \text{ V}$, $I_D = 26 \text{ A}$
- 快速开关速度
- 低栅极电荷, $Q_G = 14.3 \text{ nC}$ (典型值)
- 高性能沟道技术可实现极低的 $R_{DS(on)}$
- 高功率和高电流处理能力
- 符合 RoHS 标准

说明

此 N 沟道 MOSFET 采用飞兆半导体先进的 PowerTrench[®] 工艺生产, 这一先进工艺是专为最大限度地降低通态电阻并保持卓越开关性能而定制的。

应用

- 消费电子设备
- LED TV
- 同步整流
- 不间断电源
- 微型太阳能逆变器

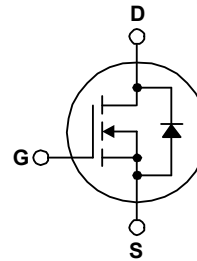
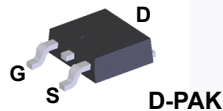

最大绝对额定值 $T_C = 25^\circ\text{C}$ 除非另有说明。

符号	参数	FDD390N15A	单位
V_{DSS}	漏极-源极电压	150	V
V_{GSS}	栅极-源极电压	- DC	± 20
		- AC (f > 1 Hz)	± 30
I_D	漏极电流	- 连续 ($T_C = 25^\circ\text{C}$, 硅限制)	26
		- 连续 ($T_C = 100^\circ\text{C}$, 硅限制)	17
I_{DM}	漏极电流	- 脉冲 (说明 1)	104
E_{AS}	单脉冲雪崩能量	(说明 2)	78
dv/dt	二极管恢复 dv/dt 峰值	(说明 3)	6.0
P_D	功耗	($T_C = 25^\circ\text{C}$)	63
		- 降低至 25°C 以上	0.5
T_J, T_{STG}	工作和存储温度范围	-55 至 +150	$^\circ\text{C}$
T_L	用于焊接的最大引线温度, 距离外壳 1/8", 持续 5 秒	300	$^\circ\text{C}$

热性能

符号	参数	FDD390N15A	单位
$R_{\theta JC}$	结至外壳热阻最大值	2.0	$^\circ\text{C}/\text{W}$
$R_{\theta JA}$	结至环境热阻最大值	87	

封装标识与订购信息

器件编号	顶标	封装	包装方法	卷尺寸	带宽	数量
FDD390N15A	FDD390N15A	DPAK	卷带	330 mm	16 mm	2500 个

电气特性 $T_C = 25^\circ\text{C}$ 除非另有说明。

符号	参数	测试条件	最小值	典型值	最大值	单位
----	----	------	-----	-----	-----	----

关断特性

BV_{DSS}	漏极-源极击穿电压	$I_D = 250 \mu\text{A}, V_{GS} = 0 \text{ V}$	150	-	-	V
$\Delta BV_{DSS} / \Delta T_J$	击穿电压温度系数	$I_D = 250 \mu\text{A}$, 推荐选用 25°C	-	0.1	-	V°C
I_{DSS}	零栅极电压漏极电流	$V_{DS} = 120 \text{ V}, V_{GS} = 0 \text{ V}$	-	-	1	μA
		$V_{DS} = 120 \text{ V}, T_C = 125^\circ\text{C}$	-	-	500	
I_{GSS}	栅极-体漏电流	$V_{GS} = \pm 20 \text{ V}, V_{DS} = 0 \text{ V}$	-	-	± 100	nA

导通特性

$V_{GS(th)}$	栅极阈值电压	$V_{GS} = V_{DS}, I_D = 250 \mu\text{A}$	2.0	-	4.0	V
$R_{DS(on)}$	漏极至源极静态导通电阻	$V_{GS} = 10 \text{ V}, I_D = 26 \text{ A}$	-	33.5	40	$\text{m}\Omega$
g_{FS}	正向跨导	$V_{DS} = 10 \text{ V}, I_D = 26 \text{ A}$	-	33	-	S

动态特性

C_{iss}	输入电容	$V_{DS} = 75 \text{ V}, V_{GS} = 0 \text{ V}, f = 1 \text{ MHz}$	-	965	1285	pF
C_{oss}	输出电容		-	96	130	pF
C_{rss}	反向传输电容		-	5.8	-	pF
$C_{oss(er)}$	能量相关输出电容	$V_{DS} = 75 \text{ V}, V_{GS} = 0 \text{ V}$	-	169	-	pF
$Q_{g(tot)}$	10V 的栅极电荷总量	$V_{DS} = 75 \text{ V}, I_D = 27 \text{ A}, V_{GS} = 10 \text{ V}$	-	14.3	18.6	nC
Q_{gs}	栅极-源极栅极电荷		-	5.0	-	nC
Q_{gs2}	栅极平台电荷阈值		-	2.0	-	nC
Q_{gd}	栅极-漏极“米勒”电荷 (说明 4)		-	3.5	-	nC
ESR	等效串联电阻 (G-S)	$f = 1 \text{ MHz}$	-	1.4	-	Ω

开关特性

$t_{d(on)}$	导通延迟时间	$V_{DD} = 75 \text{ V}, I_D = 27 \text{ A}, V_{GS} = 10 \text{ V}, R_G = 4.7 \Omega$	-	14	38	ns
t_r	开通上升时间		-	10	30	ns
$t_{d(off)}$	关断延迟时间		-	20	50	ns
t_f	关断下降时间 (说明 4)		-	5	20	ns

漏极-源极二极管特性

I_S	漏极-源极二极管最大正向连续电流	-	-	26	A	
I_{SM}	漏极-源极二极管最大正向脉冲电流	-	-	104	A	
V_{SD}	漏极-源极二极管正向电压	$V_{GS} = 0 \text{ V}, I_{SD} = 26 \text{ A}$	-	-	1.25	V
t_{rr}	反向恢复时间	$V_{GS} = 0 \text{ V}, I_{SD} = 27 \text{ A}, V_{DD} = 75 \text{ V}, di/dt = 100 \text{ A}/\mu\text{s}$	-	63	-	ns
Q_{rr}	反向恢复电荷		-	131	-	nC

注意:

1. 重复额定值: 脉冲宽度受限于最大结温。
2. 开始 $T_J = 25^\circ\text{C}$, $L = 3 \text{ mH}$, $I_{SD} = 7.2 \text{ A}$ 。
3. $I_{SD} \leq 26 \text{ A}$, $di/dt \leq 200 \text{ A}/\mu\text{s}$, $V_{DD} \leq BV_{DSS}$, 开始 $T_J = 25^\circ\text{C}$ 。
4. 本质上独立于工作温度的典型特性。

典型性能特征

图 1. 导通区域特性



图 2. 传输特性



图 3. 导通电阻变化与漏极电流和栅极电压

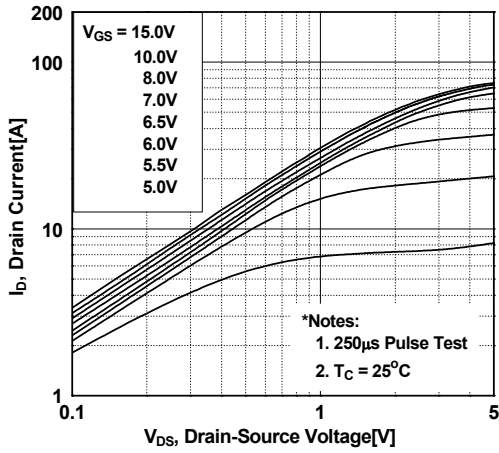

图 4. 体二极管正向电压变化与源极电流和温度

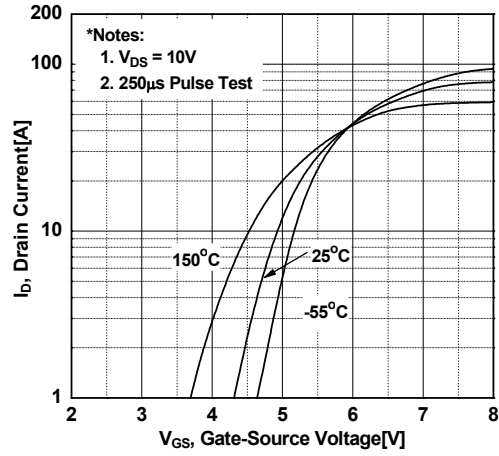

图 5. 电容特性

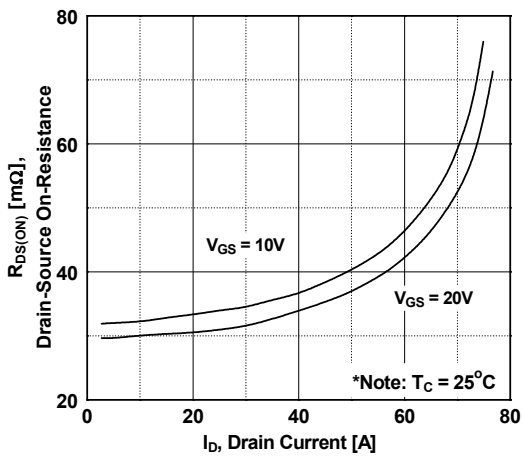

图 6. 栅极电荷

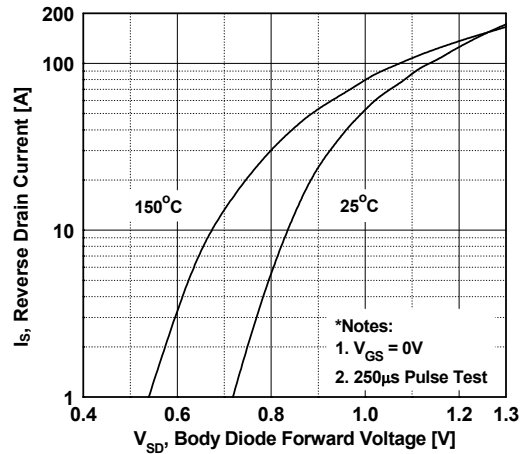

典型性能特征 (接上页)

图 7. 击穿电压变化与温度

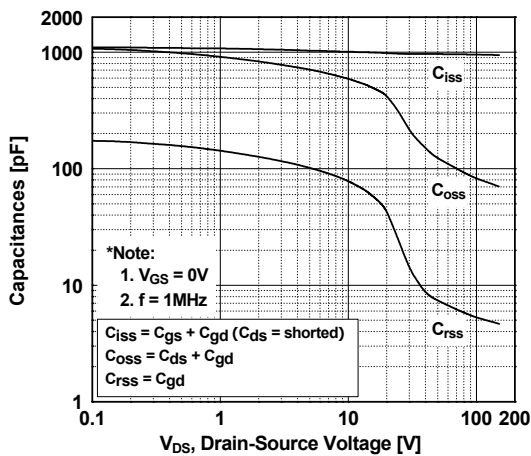
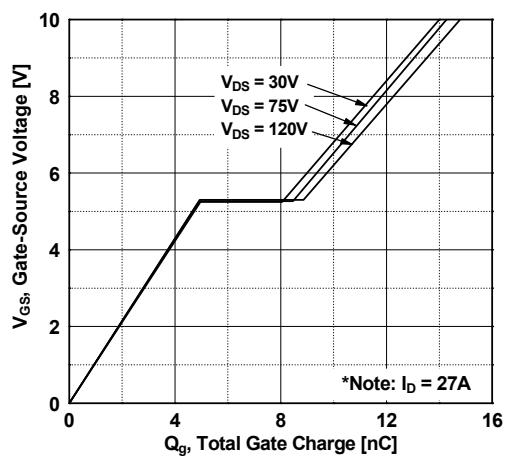

图 8. 导通电阻变化与温度



图 9. 最大安全工作区

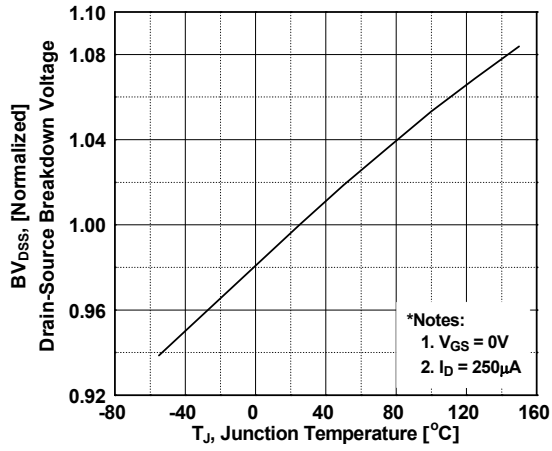

图 10. 最大漏极电流与外壳温度

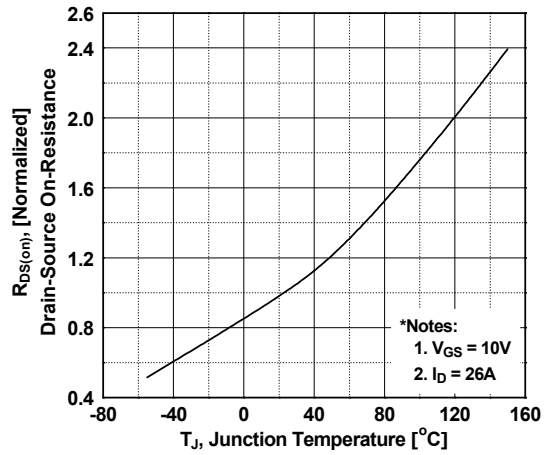

图 11. 输出电容 (Eoss) 与漏极 - 源极电压

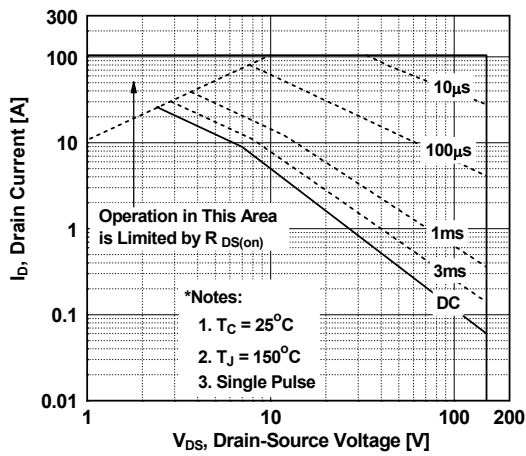

图 12. 非箝位电感开关能力

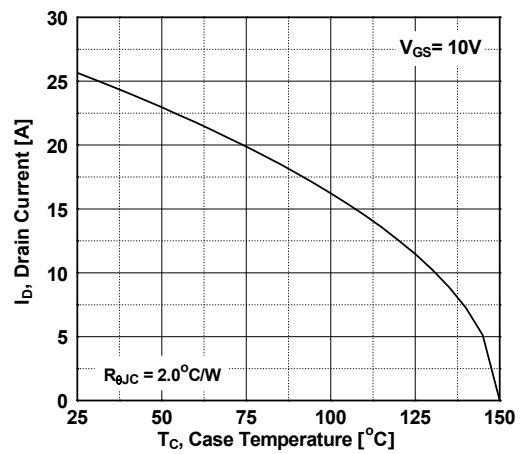

典型性能特征 (接上页)

图 13. 瞬态热响应曲线

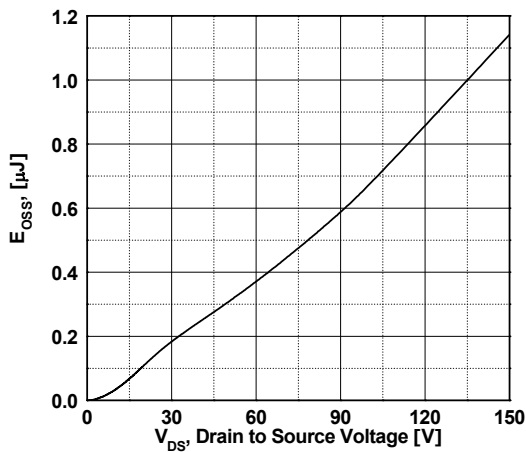
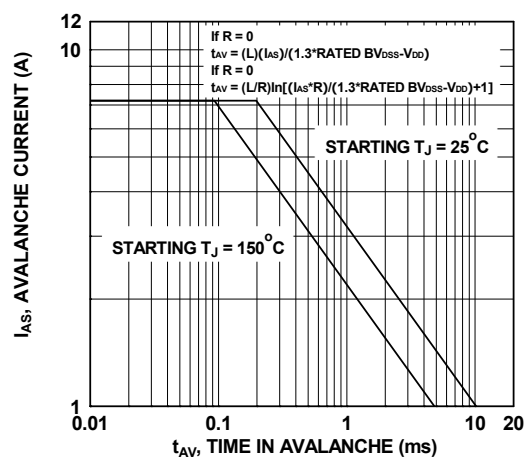
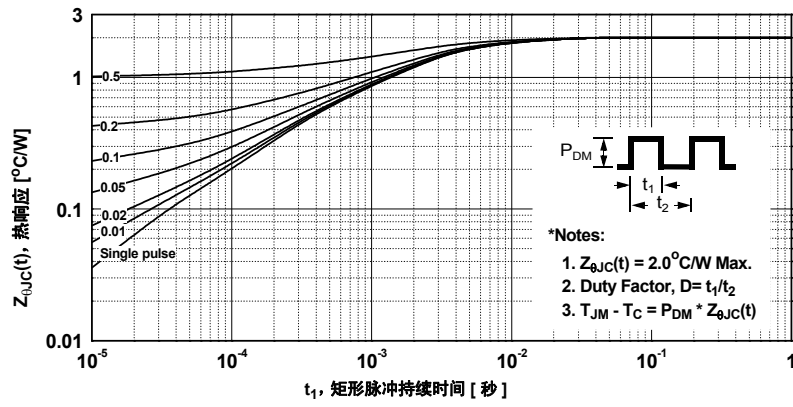



图 14. 栅极电荷测试电路与波形



图 15. 阻性开关测试电路与波形

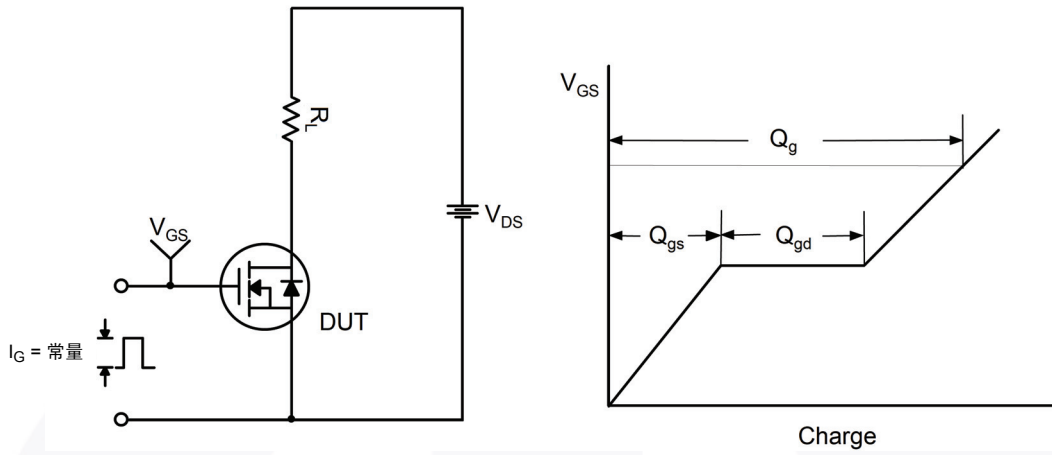

图 16. 非箝位电感开关测试电路与波形



图 17. 二极管恢复 dv/dt 峰值测试电路与波形

机械尺寸

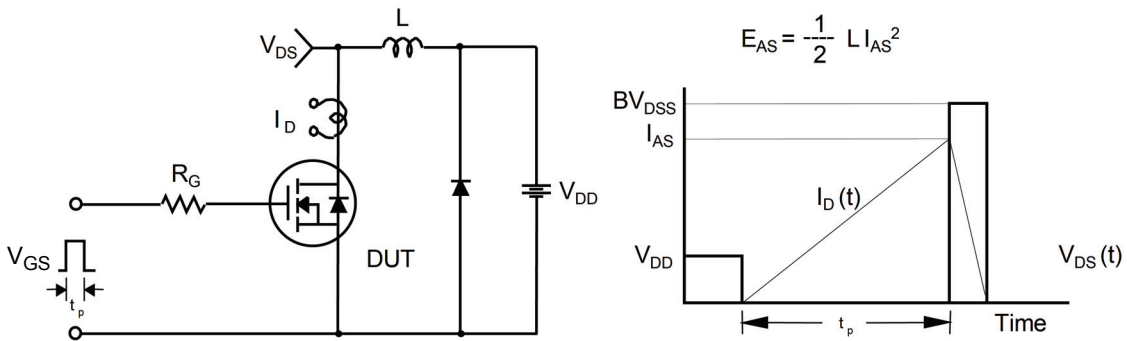

图 18. TO252 (D-PAK) 模塑 3 引线选项 AA&AB

封装图纸作为一项服务，提供给考虑飞兆半导体元件的客户。具体参数可能会有变化，且不会做出相应通知。请注意图纸上的版本和 / 或日期，并联系飞兆半导体代表核实或获得最新版本。封装规格并不超出飞兆公司全球范围内的条款与条件，尤其指保修，保修涵盖飞兆半导体的全部产品。

随时访问飞兆半导体在线封装网页，可以获取最新的封装图纸：

http://www.fairchildsemi.com/package/packageDetails.html?id=PN_TT252-003

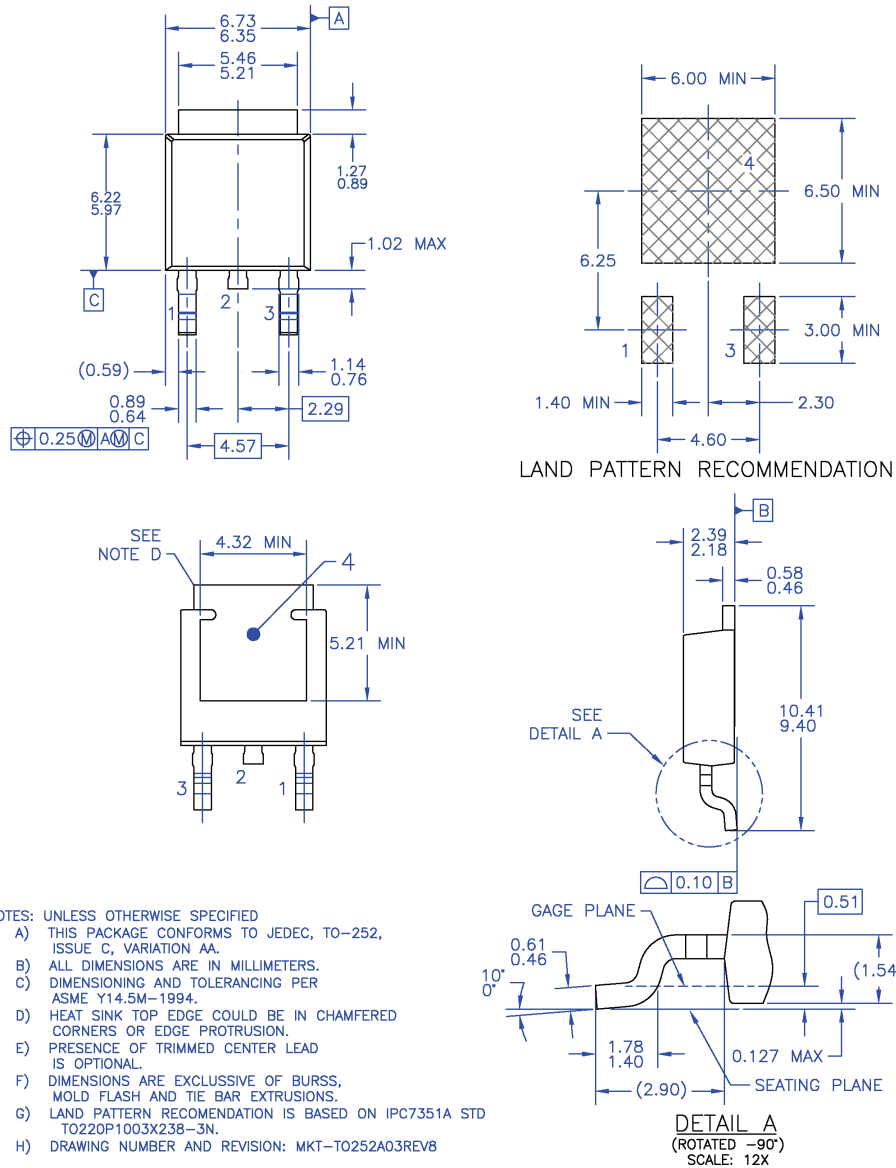
ON Semiconductor and  are trademarks of Semiconductor Components Industries, LLC dba ON Semiconductor or its subsidiaries in the United States and/or other countries. ON Semiconductor owns the rights to a number of patents, trademarks, copyrights, trade secrets, and other intellectual property. A listing of ON Semiconductor's product/patent coverage may be accessed at www.onsemi.com/site/pdf/Patent-Marking.pdf. ON Semiconductor reserves the right to make changes without further notice to any products herein. ON Semiconductor makes no warranty, representation or guarantee regarding the suitability of its products for any particular purpose, nor does ON Semiconductor assume any liability arising out of the application or use of any product or circuit, and specifically disclaims any and all liability, including without limitation special, consequential or incidental damages. Buyer is responsible for its products and applications using ON Semiconductor products, including compliance with all laws, regulations and safety requirements or standards, regardless of any support or applications information provided by ON Semiconductor. "Typical" parameters which may be provided in ON Semiconductor data sheets and/or specifications can and do vary in different applications and actual performance may vary over time. All operating parameters, including "Typicals" must be validated for each customer application by customer's technical experts. ON Semiconductor does not convey any license under its patent rights nor the rights of others. ON Semiconductor products are not designed, intended, or authorized for use as a critical component in life support systems or any FDA Class 3 medical devices or medical devices with a same or similar classification in a foreign jurisdiction or any devices intended for implantation in the human body. Should Buyer purchase or use ON Semiconductor products for any such unintended or unauthorized application, Buyer shall indemnify and hold ON Semiconductor and its officers, employees, subsidiaries, affiliates, and distributors harmless against all claims, costs, damages, and expenses, and reasonable attorney fees arising out of, directly or indirectly, any claim of personal injury or death associated with such unintended or unauthorized use, even if such claim alleges that ON Semiconductor was negligent regarding the design or manufacture of the part. ON Semiconductor is an Equal Opportunity/Affirmative Action Employer. This literature is subject to all applicable copyright laws and is not for resale in any manner.

PUBLICATION ORDERING INFORMATION

LITERATURE FULFILLMENT:

Literature Distribution Center for ON Semiconductor
19521 E. 32nd Pkwy, Aurora, Colorado 80011 USA
Phone: 303-675-2175 or 800-344-3860 Toll Free USA/Canada
Fax: 303-675-2176 or 800-344-3867 Toll Free USA/Canada
Email: orderlit@onsemi.com

N. American Technical Support: 800-282-9855 Toll Free
USA/Canada
Europe, Middle East and Africa Technical Support:
Phone: 421 33 790 2910
Japan Customer Focus Center
Phone: 81-3-5817-1050

ON Semiconductor Website: www.onsemi.com
Order Literature: <http://www.onsemi.com/orderlit>
For additional information, please contact your local
Sales Representative