

MOSFET – N-Channel, POWERTRENCH® 60 V

FDD5612

General Description

This N-Channel MOSFET has been designed specifically to improve the overall efficiency of DC/DC converters using either synchronous or conventional switching PWM controllers.

These MOSFETs feature faster switching and lower gate charge than other MOSFETs with comparable $R_{DS(ON)}$ specifications. The result is a MOSFET that is easy and safer to drive (even at very high frequencies), and DC/DC power supply designs with higher overall efficiency.

Features

- 18 A, 60 V
 - ◆ $R_{DS(ON)} = 55 \text{ m}\Omega @ V_{GS} = 10 \text{ V}$
 - ◆ $R_{DS(ON)} = 64 \text{ m}\Omega @ V_{GS} = 6 \text{ V}$
- Optimized for Use in High Frequency DC/DC Converters
- Low Gate Charge
- Very Fast Switching
- This Device is Pb-Free and are RoHS Compliant



ON Semiconductor®

www.onsemi.com

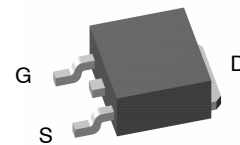
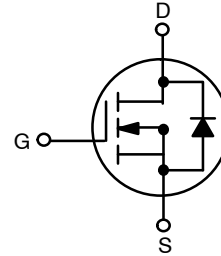

**DPAK3 (TO-252 3 LD)
CASE 369AS**

MARKING DIAGRAM

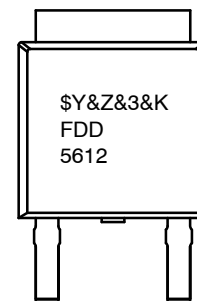

\$Y	= ON Semiconductor Logo
&Z	= Assembly Plant Code
&3	= Numeric Date Code
&K	= Lot Code
FDD5612	= Specific Device Code

ORDERING INFORMATION

See detailed ordering and shipping information on page 2 of this data sheet.

FDD5612

ABSOLUTE MAXIMUM RATINGS (T_A = 25°C, Unless otherwise noted)

Symbol	Parameter	Ratings	Units	
V _{DSS}	Drain–Source Voltage	60	V	
V _{GSS}	Gate–Source Voltage	±20	V	
I _D	Drain Current – Continuous	T _C = 25°C	18	A
		T _C = 100°C	13	
		T _A = 25°C (Note 1a)	5.4	
		T _A = 25°C (Note 1b)	3.5	
	Drain Current – Pulsed	100		
P _D	Maximum Power Dissipation	T _C = 25°C	42	W
		T _C = 100°C	21	
		T _A = 25°C (Note 1a)	3.8	
		T _A = 25°C (Note 1b)	1.6	
T _J , T _{STG}	Operating and Storage Junction Temperature Range	–55 to +175	°C	

Stresses exceeding those listed in the Maximum Ratings table may damage the device. If any of these limits are exceeded, device functionality should not be assumed, damage may occur and reliability may be affected.

THERMAL CHARACTERISTICS

Symbol	Parameter	Ratings	Unit
R _{θJC}	Thermal Resistance, Junction–to–Case	3.5	°C/W
R _{θJA}	Thermal Resistance, Junction–to–Ambient (Note 1a)	40	°C/W
R _{θJA}	Thermal Resistance, Junction–to–Ambient (Note 1b)	96	°C/W

PACKAGE MARKING AND ORDERING INFORMATION

Part Number	Device	Reel Size	Tape Width	Quantity
FDD5612	FDD5612	13"	16 mm	2500 Units

ELECTRICAL CHARACTERISTICS (T_A = 25°C unless otherwise noted)

Symbol	Parameter	Test Conditions	Min	Typ	Max	Unit
--------	-----------	-----------------	-----	-----	-----	------

DRAIN–SOURCE AVALANCHE RATINGS (Note 1)

W _{DSS}	Single Pulse Drain–Source Avalanche Energy	V _{DD} = 30 V, I _D = 5.4 A			90	mJ
I _{AR}	Maximum Drain–Source Avalanche Current				5.4	A

OFF CHARACTERISTICS

BV _{DSS}	Drain–Source Breakdown Voltage	V _{GS} = 0 V, I _D = 250 μA	60			V
ΔBV _{DSS} / ΔT _J	Breakdown Voltage Temperature Coefficient	I _D = –250 μA, Referenced to 25°C		62		mV/°C
I _{DSS}	Zero Gate Voltage Drain Current	V _{DS} = 48 V, V _{GS} = 0 V			1	μA
I _{GSSF}	Gate–Body Leakage, Forward	V _{GS} = 20 V, V _{DS} = 0 V			100	nA
I _{GSSR}	Gate–Body Leakage, Reverse	V _{GS} = –20V, V _{DS} = 0 V			–100	nA

ON CHARACTERISTICS (Note 2)

V _{GS(th)}	Gate Threshold Voltage	V _{DS} = V _{GS} , I _D = 250 μA	1	2.4	3	V
ΔV _{GS(th)} / ΔT _J	Gate Threshold Voltage Temperature Coefficient	I _D = 250 μA, Referenced to 25°C		–6		mV/°C

FDD5612

ELECTRICAL CHARACTERISTICS ($T_A = 25^\circ\text{C}$ unless otherwise noted) (continued)

Symbol	Parameter	Test Conditions	Min	Typ	Max	Unit
ON CHARACTERISTICS (Note 2)						
$R_{DS(on)}$	Static Drain-Source On-Resistance	$V_{GS} = 10\text{ V}, I_D = 5.4\text{ A}$ $V_{GS} = 6\text{ V}, I_D = 5\text{ A}$ $V_{GS} = 10\text{ V}, I_D = 5.4\text{ A}, T_J = 125^\circ\text{C}$		36 42 64	55 64 103	$\text{m}\Omega$
$I_{D(on)}$	On-State Drain Current	$V_{GS} = 10\text{ V}, V_{DS} = 5\text{ V}$	20			A
g_{FS}	Forward Transconductance	$V_{DS} = 5\text{ V}, I_D = 5.4\text{ A}$		15		S

DYNAMIC CHARACTERISTICS

C_{iss}	Input Capacitance	$V_{DS} = 30\text{ V}, V_{GS} = 0\text{ V},$ $f = 1.0\text{ MHz}$		660		pF
C_{oss}	Output Capacitance			79		pF
C_{rss}	Reverse Transfer Capacitance			36		pF

SWITCHING CHARACTERISTICS (Note 2)

$t_{d(on)}$	Turn-On Delay Time	$V_{DD} = 30\text{ V}, I_D = 1\text{ A},$ $V_{GS} = 10\text{ V}, R_{GEN} = 6\ \Omega$		8	16	ns
t_r	Turn-On Rise Time			4	8	ns
$t_{d(off)}$	Turn-Off Delay Time			24	38	ns
t_f	Turn-Off Fall Time			4	8	ns
Q_g	Total Gate Charge	$V_{DS} = 30\text{ V}, I_D = 5.4\text{ A},$ $V_{GS} = 10\text{ V}$		7.5	11	nC
Q_{gs}	Gate-Source Charge			2.5		nC
Q_{gd}	Gate-Drain Charge			3		nC

DRAIN-SOURCE DIODE CHARACTERISTICS AND MAXIMUM RATINGS

I_S	Source Current (Body Diode)	$T_C = 25^\circ\text{C}$			18	A
V_{SD}	Drain-Source Diode Forward Voltage	$V_{GS} = 0\text{ V}, I_S = 2.7\text{ A}$ (Note 2)		0.8	1.2	V

Product parametric performance is indicated in the Electrical Characteristics for the listed test conditions, unless otherwise noted. Product performance may not be indicated by the Electrical Characteristics if operated under different conditions.

NOTES:

- $R_{\theta JA}$ is the sum of the junction-to-case and case-to-ambient thermal resistance where the case thermal reference is defined as the drain tab. $R_{\theta JA}$ is the guaranteed design while $R_{\theta JA}$ is determined by the user's design. $R_{\theta JA}$ has been used to determine some of the maximum ratings.

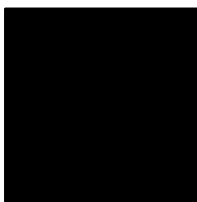

- a) $R_{\theta JA} = 40^\circ\text{C/W}$ when mounted on a 1 in^2 pad of 2 oz copper



- b) $R_{\theta JA} = 96^\circ\text{C/W}$ when mounted on a 0.076 in^2 pad of 2 oz copper

- Pulse Test: Pulse Width < 300 μs , Duty Cycle < 2.0%

TYPICAL CHARACTERISTICS

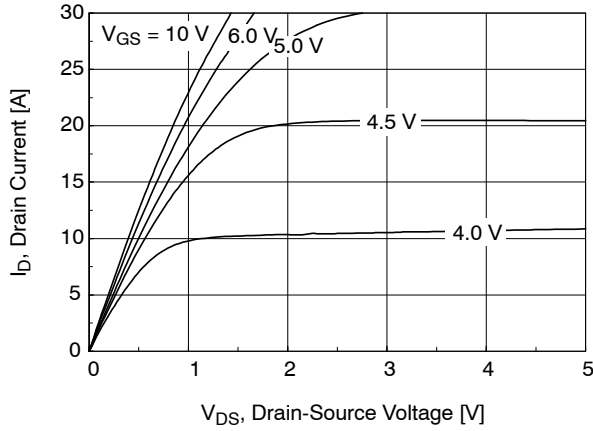

Figure 1. On-Region Characteristics

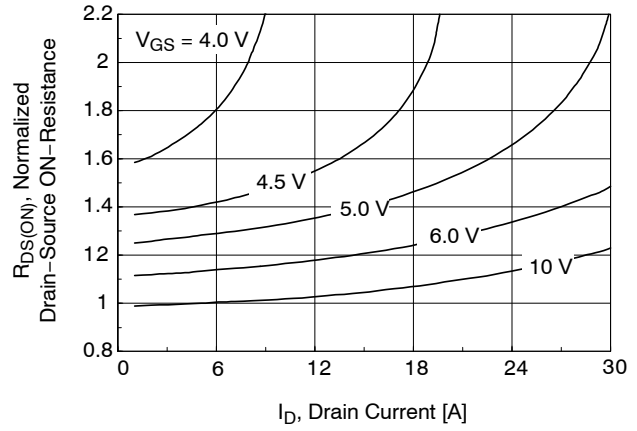

Figure 2. On-Resistance Variation with Drain Current and Gate Voltage

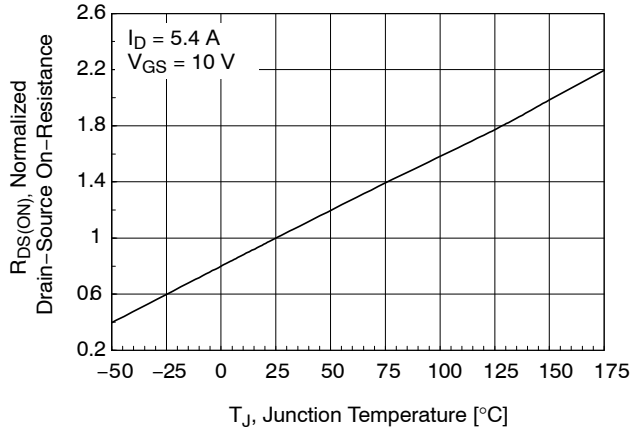

Figure 3. On-Resistance Variation with Temperature

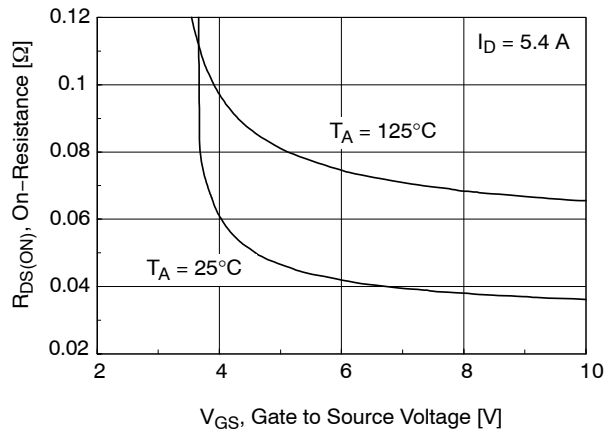

Figure 4. On-Resistance Variation with Gate-to-Source Voltage

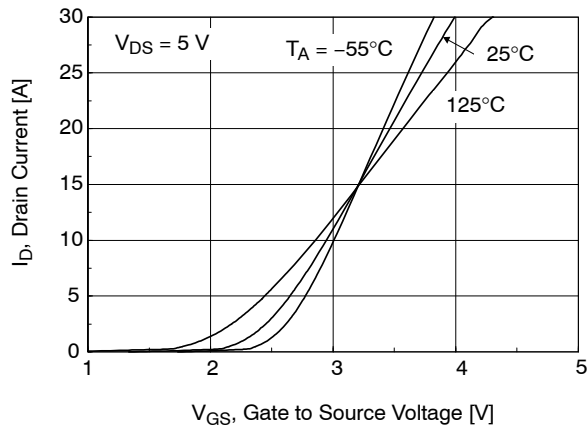

Figure 5. Transfer Characteristics

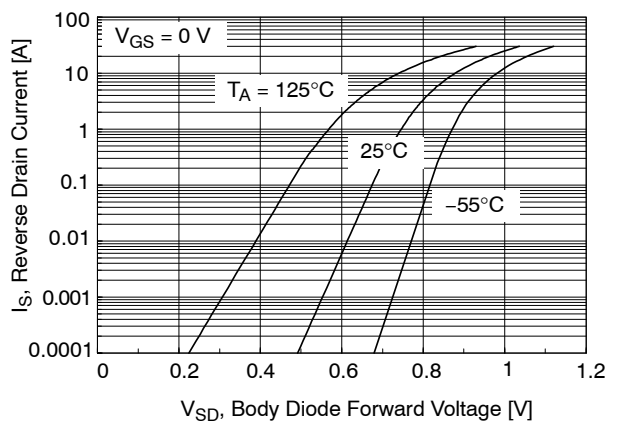

Figure 6. Body Diode Forward Voltage Variation with Source Current and Temperature

TYPICAL CHARACTERISTICS (continued)

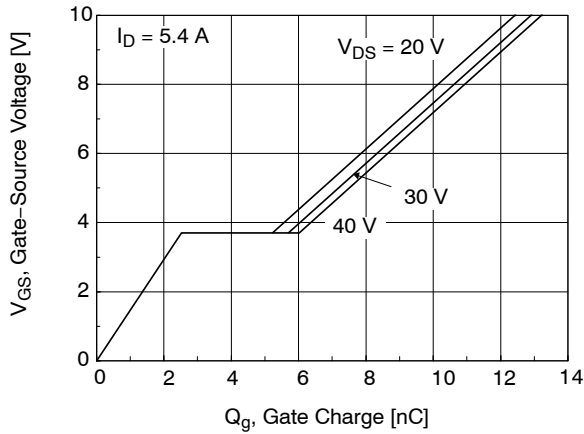

Figure 7. Gate Charge Characteristics

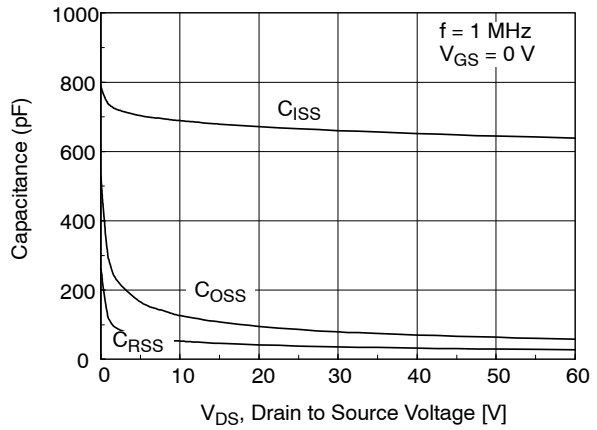

Figure 8. Capacitance Characteristics

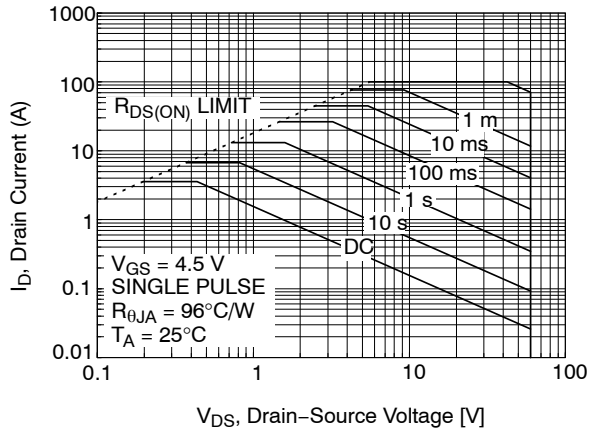

Figure 9. Maximum Safe Operating Area

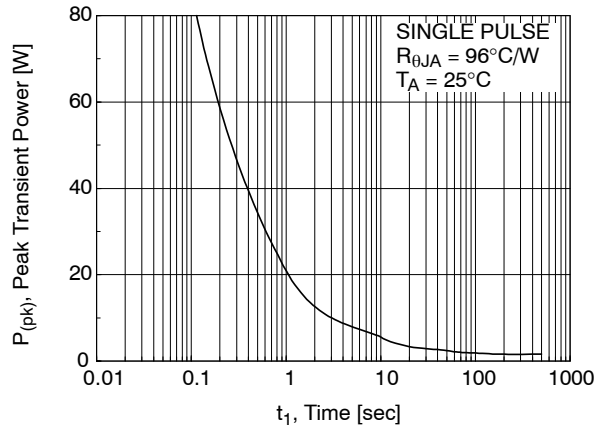

Figure 10. Single Pulse Maximum Power Dissipation

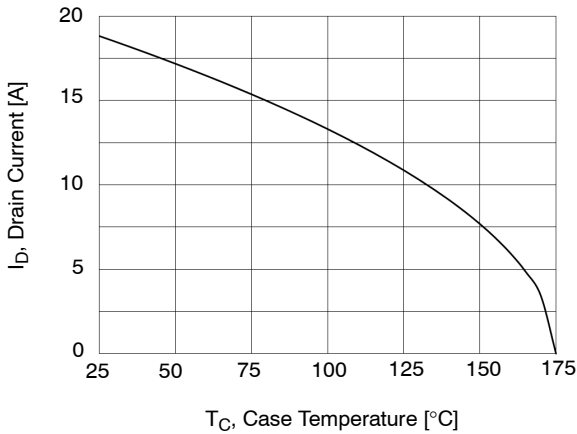

Figure 11. Maximum Drain Current vs. Case Temperature

FDD5612

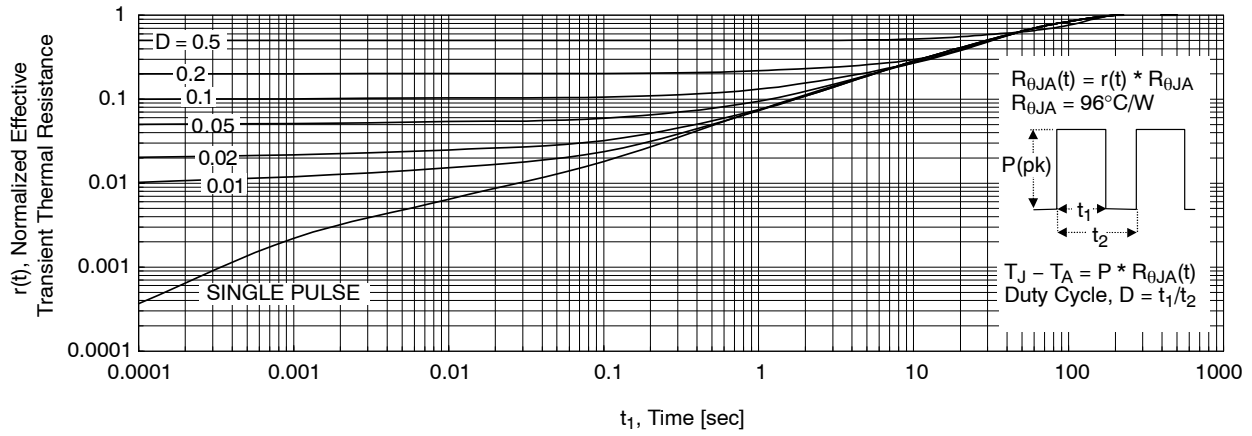
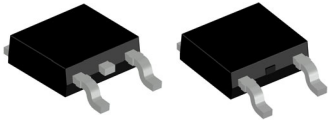

Figure 12. Transient Thermal Response Curve

NOTES:

3. Thermal characterization performed using the conditions described in Note 1b.
4. Transient thermal response will change depending on the circuit board design.

MECHANICAL CASE OUTLINE PACKAGE DIMENSIONS



DPAK3 6.10x6.54x2.29, 4.57P CASE 369AS ISSUE B

DATE 20 DEC 2023

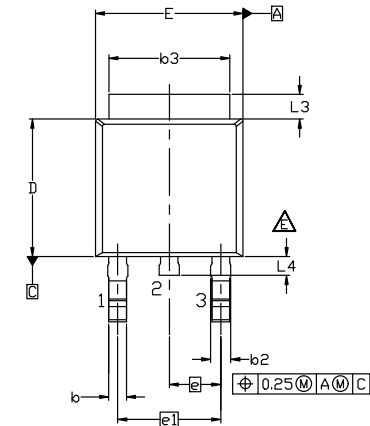

- NOTES: UNLESS OTHERWISE SPECIFIED
- A) THIS PACKAGE CONFORMS TO JEDEC, TO-252, ISSUE F, VARIATION AA.
 - B) ALL DIMENSIONS ARE IN MILLIMETERS.
 - C) DIMENSIONING AND TOLERANCING PER ASME Y14.5M-2018.
 - D) SUPPLIER DEPENDENT MOLD LOCKING HOLES OR CHAMFERED CORNERS OR EDGE PROTRUSION.
 - E) FOR DIODE PRODUCTS, L4 IS 0.25 MM MAX PLASTIC BODY STUB WITHOUT CENTER LEAD.
 - F) DIMENSIONS ARE EXCLUSIVE OF BURRS, MOLD FLASH AND TIE BAR EXTRUSIONS.
 - G) LAND PATTERN RECOMMENDATION IS BASED ON IPC7351A STD TD228P991X239-3N.

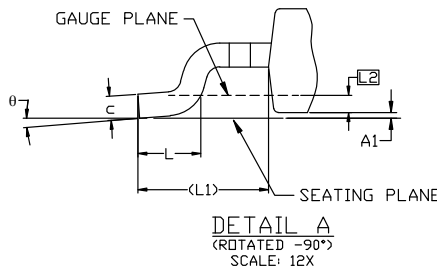
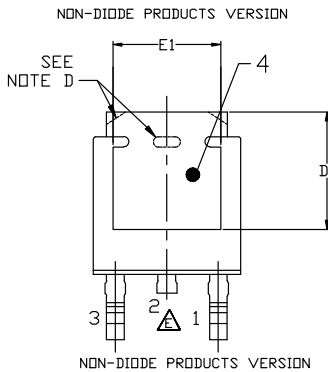

DIM	MILLIMETERS		
	MIN.	NOM.	MAX.
A	2.18	2.29	2.39
A1	0.00	-	0.127
b	0.64	0.77	0.89
b2	0.76	0.95	1.14
b3	5.21	5.34	5.46
c	0.45	0.53	0.61
c2	0.45	0.52	0.58
D	5.97	6.10	6.22
D1	5.21	---	---
E	6.35	6.54	6.73
E1	4.32	---	---
e	2.286 BSC		
e1	4.572 BSC		
H	9.40	9.91	10.41
L	1.40	1.59	1.78
L1	2.90 REF		
L2	0.51 BSC		
L3	0.89	1.08	1.27
L4	---	---	1.02
θ	0°	---	10°

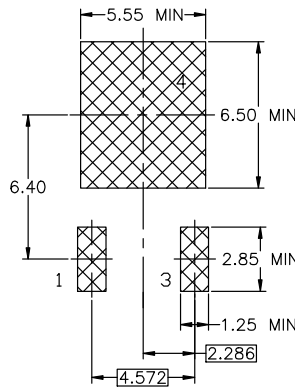

LAND PATTERN RECOMMENDATION

*FOR ADDITIONAL INFORMATION ON OUR PB-FREE STRATEGY AND SOLDERING DETAILS, PLEASE DOWNLOAD THE ON SEMICONDUCTOR SOLDERING AND MOUNTING TECHNIQUES REFERENCE MANUAL, SOLDERM/D.

GENERIC MARKING DIAGRAM*

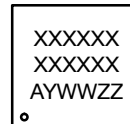

*This information is generic. Please refer to device data sheet for actual part marking. Pb-free indicator, "G" or microdot "•", may or may not be present. Some products may not follow the Generic Marking.

XXXX = Specific Device Code
 A = Assembly Location
 Y = Year
 WW = Work Week
 ZZ = Assembly Lot Code

DOCUMENT NUMBER:	98AON13810G	Electronic versions are uncontrolled except when accessed directly from the Document Repository. Printed versions are uncontrolled except when stamped "CONTROLLED COPY" in red.
DESCRIPTION:	DPAK3 6.10x6.54x2.29, 4.57P	PAGE 1 OF 1

onsemi and ONSEMI are trademarks of Semiconductor Components Industries, LLC dba onsemi or its subsidiaries in the United States and/or other countries. onsemi reserves the right to make changes without further notice to any products herein. onsemi makes no warranty, representation or guarantee regarding the suitability of its products for any particular purpose, nor does onsemi assume any liability arising out of the application or use of any product or circuit, and specifically disclaims any and all liability, including without limitation special, consequential or incidental damages. onsemi does not convey any license under its patent rights nor the rights of others.

onsemi, **Onsemi**, and other names, marks, and brands are registered and/or common law trademarks of Semiconductor Components Industries, LLC dba "**onsemi**" or its affiliates and/or subsidiaries in the United States and/or other countries. **onsemi** owns the rights to a number of patents, trademarks, copyrights, trade secrets, and other intellectual property. A listing of **onsemi**'s product/patent coverage may be accessed at www.onsemi.com/site/pdf/Patent-Marking.pdf. **onsemi** reserves the right to make changes at any time to any products or information herein, without notice. The information herein is provided "as-is" and **onsemi** makes no warranty, representation or guarantee regarding the accuracy of the information, product features, availability, functionality, or suitability of its products for any particular purpose, nor does **onsemi** assume any liability arising out of the application or use of any product or circuit, and specifically disclaims any and all liability, including without limitation special, consequential or incidental damages. Buyer is responsible for its products and applications using **onsemi** products, including compliance with all laws, regulations and safety requirements or standards, regardless of any support or applications information provided by **onsemi**. "Typical" parameters which may be provided in **onsemi** data sheets and/or specifications can and do vary in different applications and actual performance may vary over time. All operating parameters, including "Typicals" must be validated for each customer application by customer's technical experts. **onsemi** does not convey any license under any of its intellectual property rights nor the rights of others. **onsemi** products are not designed, intended, or authorized for use as a critical component in life support systems or any FDA Class 3 medical devices or medical devices with a same or similar classification in a foreign jurisdiction or any devices intended for implantation in the human body. Should Buyer purchase or use **onsemi** products for any such unintended or unauthorized application, Buyer shall indemnify and hold **onsemi** and its officers, employees, subsidiaries, affiliates, and distributors harmless against all claims, costs, damages, and expenses, and reasonable attorney fees arising out of, directly or indirectly, any claim of personal injury or death associated with such unintended or unauthorized use, even if such claim alleges that **onsemi** was negligent regarding the design or manufacture of the part. **onsemi** is an Equal Opportunity/Affirmative Action Employer. This literature is subject to all applicable copyright laws and is not for resale in any manner.

ADDITIONAL INFORMATION

TECHNICAL PUBLICATIONS:

Technical Library: www.onsemi.com/design/resources/technical-documentation
onsemi Website: www.onsemi.com

ONLINE SUPPORT: www.onsemi.com/support

For additional information, please contact your local Sales Representative at www.onsemi.com/support/sales