

MOSFET – Single, N-Channel, POWERTRENCH®

80 V, 6 A, 36.5 mΩ

FDMA037N08LC

Description

This device has been designed to provide maximum efficiency and thermal performance for synchronous buck converters. The low $R_{DS(on)}$ and gate charge provide excellent switching performance.

Features

- PTNG MOSFET Technology
- Max $R_{DS(on)}$ = 36.5 mΩ at $V_{GS} = 10\text{ V}$, $I_D = 4\text{ A}$
- Max $R_{DS(on)}$ = 56.9 mΩ at $V_{GS} = 4.5\text{ V}$, $I_D = 3\text{ A}$
- 5 V Drive Capable
- 50% Lower Q_{rr} than Other MOSFET Suppliers
- Lower Switching Noise/EMI
- Low Profile – 0.8 mm Maximum in the New Package MicroFET™ 2x2 mm
- These Devices are Pb-Free, Halogen Free/BFR Free and are RoHS Compliant

Typical Applications

- DC-DC Buck Converters

V_{DS}	$R_{DS(on)}$ MAX	I_D MAX
80 V	36.5 mΩ @ 10 V	6 A

Single N-Channel

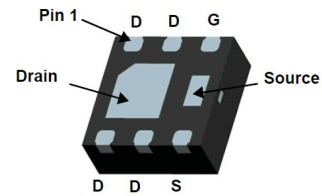
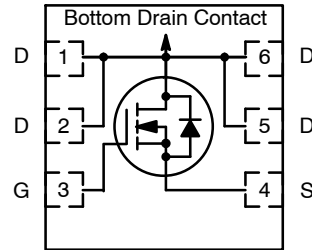

MicroFET 2X2 (Bottom View)

WDFN6 2x2, 0.65P
CASE 511DB

MARKING DIAGRAM

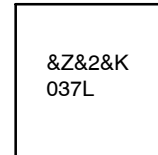

- &Z = Assembly Plant Code
- &2 = Numeric Date Code
- &K = Lot Code
- 037L = Specific Device Code

ORDERING INFORMATION

See detailed ordering and shipping information on page 2 of this data sheet.

FDMA037N08LC

MOSFET MAXIMUM RATINGS (T_A = 25°C, Unless otherwise specified)

Symbol	Parameter	Ratings	Unit
V _{DS}	Drain to Source Voltage	80	V
V _{GS}	Gate to Source Voltage	±20	V
I _D	Continuous T _A = 25°C (Note 1a)	6	A
	Pulsed	55	
P _D	Power Dissipation T _A = 25°C (Note 1a)	2.4	W
	Power Dissipation T _A = 25°C (Note 1b)	0.9	
T _J , T _{STG}	Operating and Storage Junction Temperature Range	-55 to +150	°C

Stresses exceeding those listed in the Maximum Ratings table may damage the device. If any of these limits are exceeded, device functionality should not be assumed, damage may occur and reliability may be affected.

THERMAL CHARACTERISTICS

Symbol	Parameter	Ratings	Unit
R _{θJA}	Thermal Resistance, Junction to Ambient (Note 1a)	52	°C/W
R _{θJA}	Thermal Resistance, Junction to Ambient (Note 1b)	145	

PACKAGE MARKING AND ORDERING INFORMATION

Device Marking	Device	Package	Reel Size	Tape Width	Shipping (Qty / Packing) [†]
037L	FDMA037N08LC	WDFN6 2x2, 0.65P (MicroFET) (Pb-Free/Halogen Free)	7"	8 mm	3000 / Tape & Reel

[†]For information on tape and reel specifications, including part orientation and tape sizes, please refer to our Tape and Reel Packaging Specifications Brochure, BRD8011/D.

ELECTRICAL CHARACTERISTICS (T_J = 25°C unless otherwise noted)

Symbol	Parameter	Test Conditions	Min	Typ	Max	Unit
--------	-----------	-----------------	-----	-----	-----	------

OFF CHARACTERISTICS

BV _{DSS}	Drain to Source Breakdown Voltage	I _D = 250 μA, V _{GS} = 0 V	80	-	-	V
$\frac{\Delta BV_{DSS}}{\Delta T_J}$	Breakdown Voltage Temperature Coefficient	I _D = 250 μA, referenced to 25°C	-	69	-	mV/°C
I _{DSS}	Zero Gate Voltage Drain Current	V _{DS} = 64 V, V _{GS} = 0 V	-	-	-1	μA
I _{GSS}	Gate to Source Leakage Current	V _{GS} = ±20 V, V _{DS} = 0 V	-	-	±1	μA

ON CHARACTERISTICS

V _{GS(th)}	Gate to Source Threshold Voltage	V _{GS} = V _{DS} , I _D = 20 μA	1.0	1.3	2.5	V
$\frac{\Delta V_{GS(th)}}{\Delta T_J}$	Gate to Source Threshold Voltage Temperature Coefficient	I _D = 20 μA, referenced to 25°C	-	-5	-	mV/°C
R _{DS(on)}	Static Drain to Source On Resistance	V _{GS} = 10 V, I _D = 4 A	-	30.9	36.5	mΩ
		V _{GS} = 4.5 V, I _D = 3 A	-	42.1	56.9	
		V _{GS} = 10 V, I _D = 4 A, T _J = 125°C	-	51.4	61	
g _{FS}	Forward Transconductance	V _{DD} = 5 V, I _D = 4 A	-	15	-	S

DYNAMIC CHARACTERISTICS

C _{iss}	Input Capacitance	V _{DS} = 40 V, V _{GS} = 0 V, f = 1 MHz	-	425	595	pF
C _{oss}	Output Capacitance		-	110	155	pF
C _{rss}	Reverse Transfer Capacitance		-	6.0	8.3	pF

FDMA037N08LC

ELECTRICAL CHARACTERISTICS (T_J = 25°C unless otherwise noted)

Symbol	Parameter	Test Conditions	Min	Typ	Max	Unit
SWITCHING CHARACTERISTICS						
t _{d(on)}	Turn-on Delay Time	V _{DD} = 40 V, I _D = 4 A, V _{GS} = 10 V, R _{GEN} = 6 Ω	–	4.9	10	ns
t _r	Rise Time		–	1.3	10	
t _{d(off)}	Turn-off Delay Time		–	14	24	
t _f	Fall Time		–	1.7	10	
Q _g	Total Gate Charge	V _{GS} = 0V to 10 V, V _{DD} = 40 V, I _D = 4 A	–	6.5	9.0	nC
Q _g	Total Gate Charge	V _{GS} = 0V to 4.5 V, V _{DD} = 40 V, I _D = 4 A	–	3.2	4.5	nC
Q _{gs}	Gate to Source Charge	V _{DD} = 40 V, I _D = 4 A	–	0.9	–	nC
Q _{gd}	Gate to Drain "Miller" Charge	V _{DD} = 40 V, I _D = 4 A	–	0.9	–	nC
Q _{oss}	Output Charge	V _{DD} = 40 V, V _{GS} = 0 V	–	6.4	–	nC
Q _{sync}	Total Gate Charge Sync	V _{DS} = 0 V, I _D = 4 A	–	5.9	–	nC

DRAIN-SOURCE DIODE CHARACTERISTICS

V _{SD}	Source to Drain Diode Forward Voltage	V _{GS} = 0 V, I _S = 2 A (Note 2)	–	0.8	1.2	V
		V _{GS} = 0 V, I _S = 4 A (Note 2)	–	0.8	1.3	V
t _{rr}	Reverse Recovery Time	I _F = 2 A, di/dt = 300 A/μs	–	10	20	ns
Q _{rr}	Reverse Recovery Charge		–	9	14	nC
t _{rr}	Reverse Recovery Time	I _F = 2 A, di/dt = 1000 A/μs	–	8	16	ns
Q _{rr}	Reverse Recovery Charge		–	26	51	nC

Product parametric performance is indicated in the Electrical Characteristics for the listed test conditions, unless otherwise noted. Product performance may not be indicated by the Electrical Characteristics if operated under different conditions.

NOTES:

- R_{θJA} is determined with the device mounted on a 1 in² pad 2 oz copper pad on a 1.5 × 1.5 in. board of FR-4 material. R_{θJC} is guaranteed by design while R_{θJA} is determined by the user's board design.

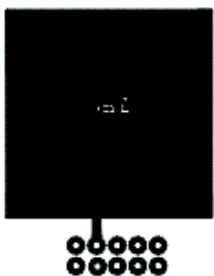

- a) 52°C/W when mounted on a 1 in² pad of 2 oz copper.

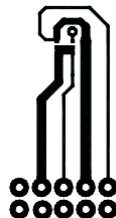

- b) 145°C/W when mounted on a minimum pad of 2 oz copper.

- Pulse Test: Pulse Width < 300 μs, Duty cycle < 2.0%.
- The diode connected between the gate and source serves only as protection against ESD. No gate overvoltage rating is implied.

TYPICAL CHARACTERISTICS ($T_J = 25^\circ\text{C}$ UNLESS OTHERWISE NOTED)

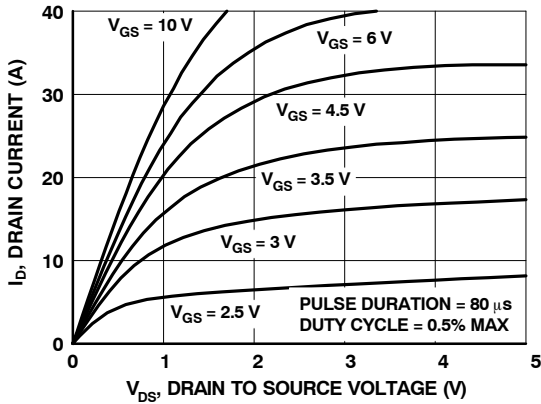

Figure 1. On Region Characteristics

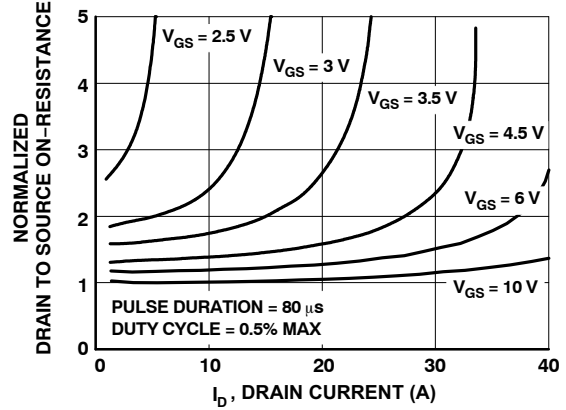

Figure 2. Normalized On-Resistance vs. Drain Current and Gate Voltage

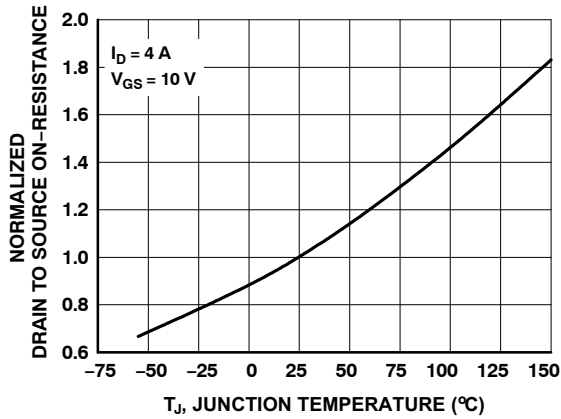

Figure 3. Normalized On Resistance vs. Junction Temperature

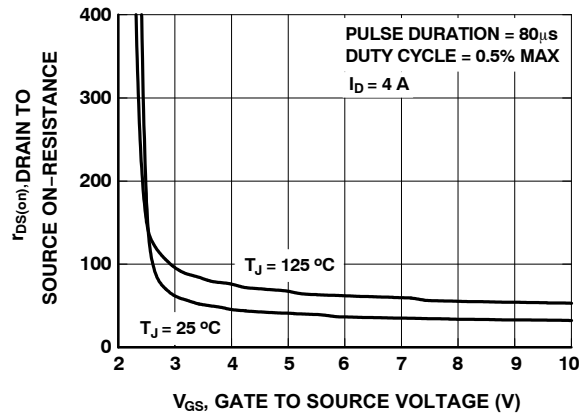

Figure 4. On-Resistance vs. Gate to Source Voltage

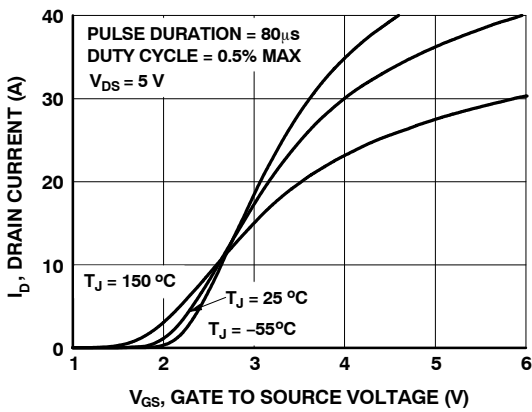

Figure 5. Transfer Characteristics

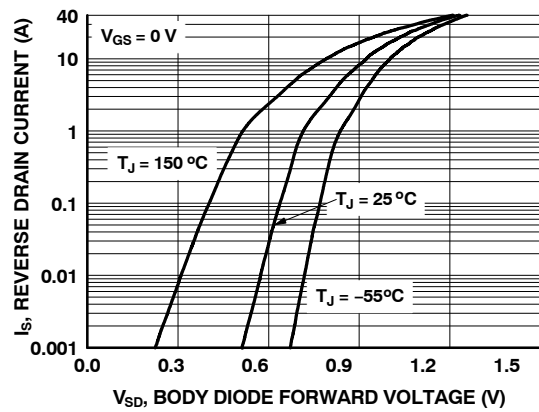

Figure 6. Source to Drain Diode Forward Voltage vs. Source Current

TYPICAL CHARACTERISTICS (CONTINUED)

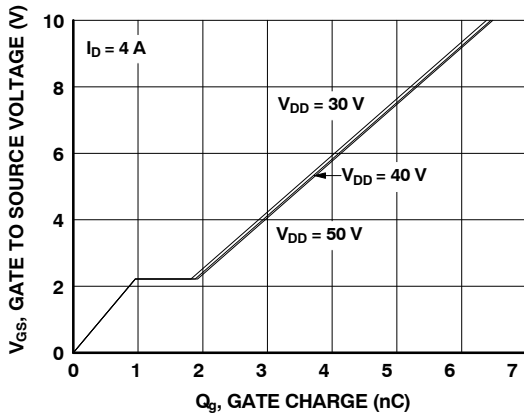

Figure 7. Gate Charge Characteristics

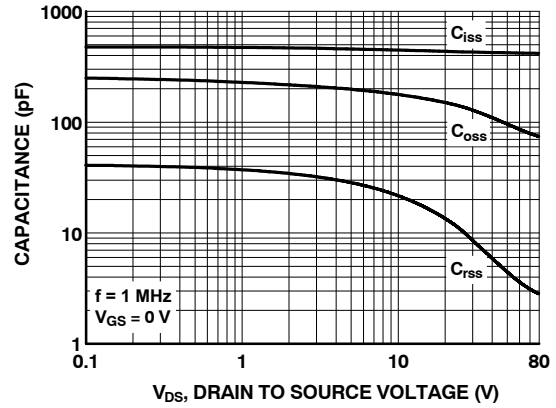

Figure 8. Capacitance vs. Drain to Source Voltage

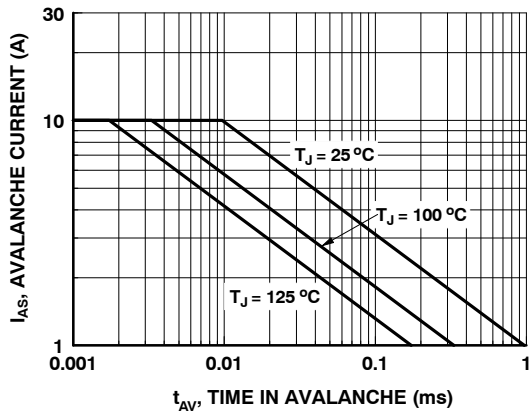

Figure 9. Unclamped Inductive Switching Capability

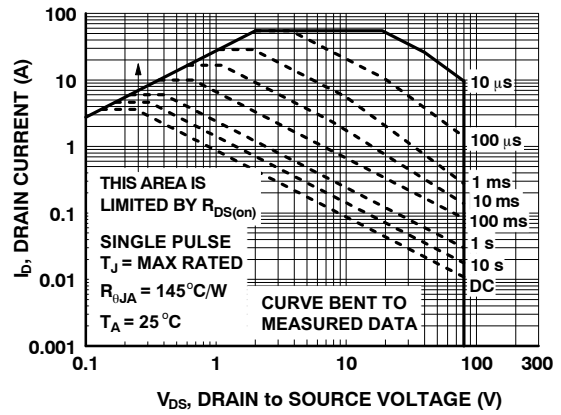

Figure 10. Forward Bias Safe Operating Area

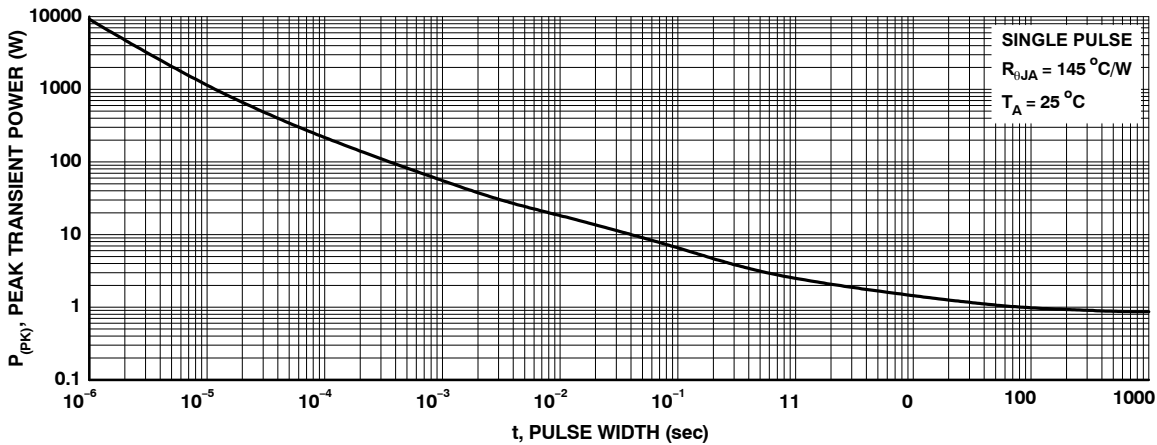

Figure 11. Single Pulse Maximum Power Dissipation

TYPICAL CHARACTERISTICS (CONTINUED)

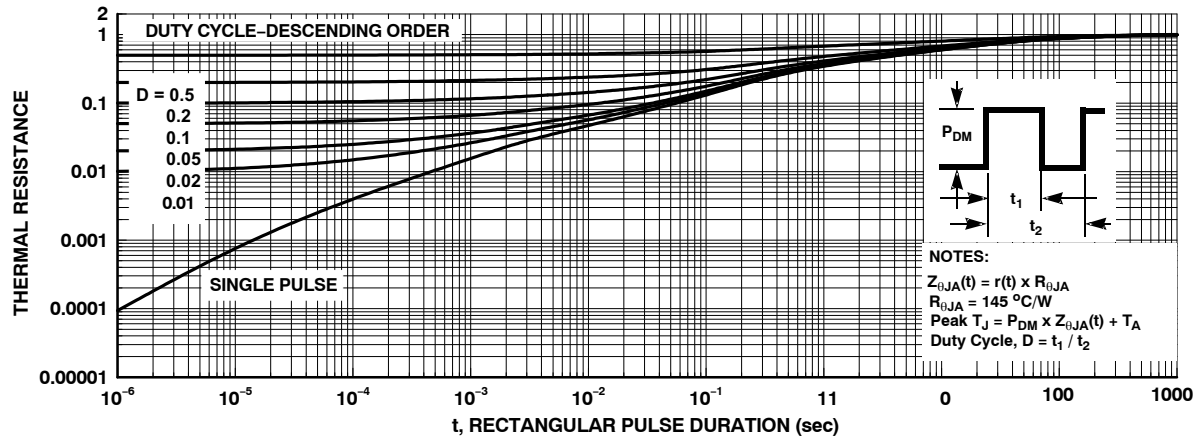
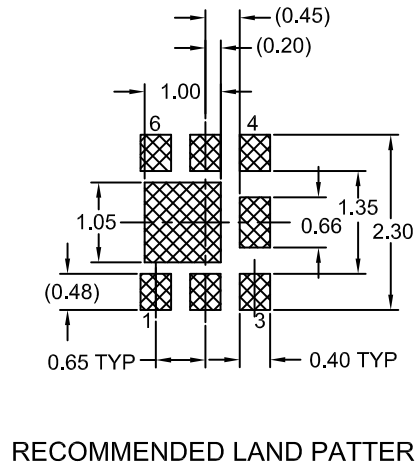
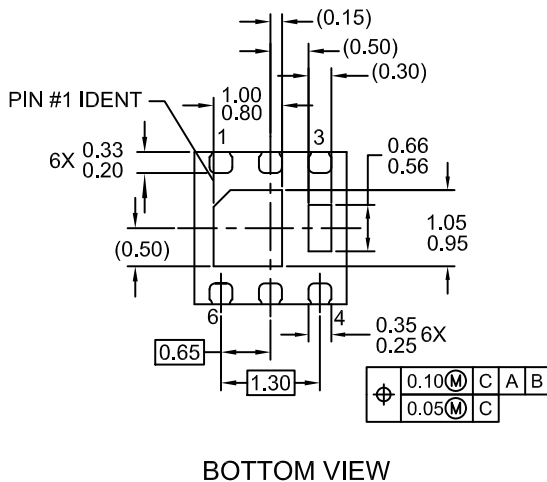
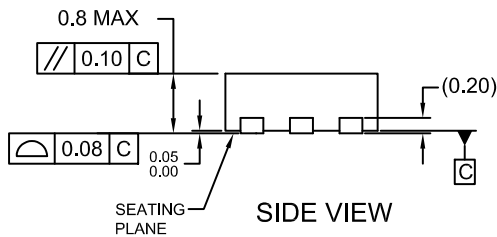
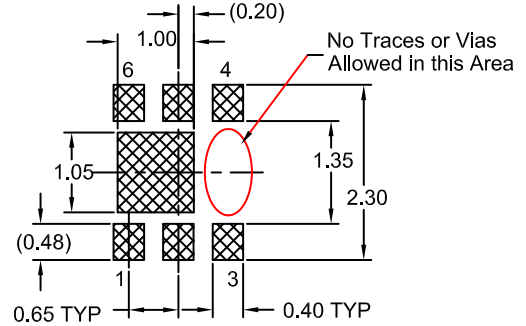
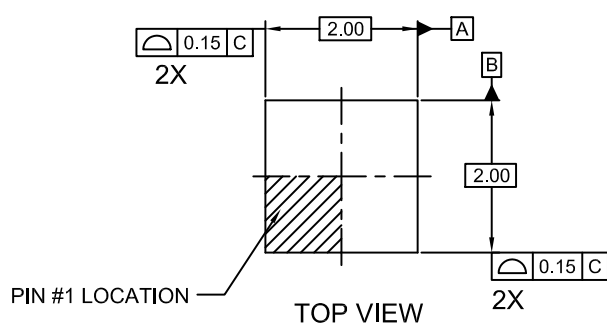

Figure 12. Junction-to-Case Transient Thermal Response Curve

MECHANICAL CASE OUTLINE
PACKAGE DIMENSIONS

WDFN6 2x2, 0.65P
CASE 511DB
ISSUE O

DATE 31 AUG 2016



NOTES:

- A. DOES NOT FULLY CONFORM TO JEDEC REGISTRATION MO-229 DATED AUG/2003
- B. DIMENSIONS ARE IN MILLIMETERS.
- C. DIMENSIONS AND TOLERANCES PER ASME Y14.5M, 1994

DOCUMENT NUMBER:	98AON13617G	Electronic versions are uncontrolled except when accessed directly from the Document Repository. Printed versions are uncontrolled except when stamped "CONTROLLED COPY" in red.
DESCRIPTION:	WDFN6 2X2, 0.65P	PAGE 1 OF 1

ON Semiconductor and **ON** are trademarks of Semiconductor Components Industries, LLC dba ON Semiconductor or its subsidiaries in the United States and/or other countries. ON Semiconductor reserves the right to make changes without further notice to any products herein. ON Semiconductor makes no warranty, representation or guarantee regarding the suitability of its products for any particular purpose, nor does ON Semiconductor assume any liability arising out of the application or use of any product or circuit, and specifically disclaims any and all liability, including without limitation special, consequential or incidental damages. ON Semiconductor does not convey any license under its patent rights nor the rights of others.

onsemi, **Onsemi**, and other names, marks, and brands are registered and/or common law trademarks of Semiconductor Components Industries, LLC dba "**onsemi**" or its affiliates and/or subsidiaries in the United States and/or other countries. **onsemi** owns the rights to a number of patents, trademarks, copyrights, trade secrets, and other intellectual property. A listing of **onsemi**'s product/patent coverage may be accessed at www.onsemi.com/site/pdf/Patent-Marking.pdf. **onsemi** reserves the right to make changes at any time to any products or information herein, without notice. The information herein is provided "as-is" and **onsemi** makes no warranty, representation or guarantee regarding the accuracy of the information, product features, availability, functionality, or suitability of its products for any particular purpose, nor does **onsemi** assume any liability arising out of the application or use of any product or circuit, and specifically disclaims any and all liability, including without limitation special, consequential or incidental damages. Buyer is responsible for its products and applications using **onsemi** products, including compliance with all laws, regulations and safety requirements or standards, regardless of any support or applications information provided by **onsemi**. "Typical" parameters which may be provided in **onsemi** data sheets and/or specifications can and do vary in different applications and actual performance may vary over time. All operating parameters, including "Typicals" must be validated for each customer application by customer's technical experts. **onsemi** does not convey any license under any of its intellectual property rights nor the rights of others. **onsemi** products are not designed, intended, or authorized for use as a critical component in life support systems or any FDA Class 3 medical devices or medical devices with a same or similar classification in a foreign jurisdiction or any devices intended for implantation in the human body. Should Buyer purchase or use **onsemi** products for any such unintended or unauthorized application, Buyer shall indemnify and hold **onsemi** and its officers, employees, subsidiaries, affiliates, and distributors harmless against all claims, costs, damages, and expenses, and reasonable attorney fees arising out of, directly or indirectly, any claim of personal injury or death associated with such unintended or unauthorized use, even if such claim alleges that **onsemi** was negligent regarding the design or manufacture of the part. **onsemi** is an Equal Opportunity/Affirmative Action Employer. This literature is subject to all applicable copyright laws and is not for resale in any manner.

ADDITIONAL INFORMATION

TECHNICAL PUBLICATIONS:

Technical Library: www.onsemi.com/design/resources/technical-documentation
onsemi Website: www.onsemi.com

ONLINE SUPPORT: www.onsemi.com/support

For additional information, please contact your local Sales Representative at www.onsemi.com/support/sales