

# MOSFET – Single, N-Channel, POWERTRENCH®

100 V, 3.3 A, 88 mΩ

## FDMA86151L

### General Description

This device has been designed to provide maximum efficiency and thermal performance for synchronous buck converters. The low  $R_{DS(on)}$  and gate charge provide excellent switching performance.

### Features

- Max  $R_{DS(on)}$  = 88 mΩ @  $V_{GS} = 10\text{ V}$ ,  $I_D = 3.3\text{ A}$
- Max  $R_{DS(on)}$  = 132 mΩ @  $V_{GS} = 4.5\text{ V}$ ,  $I_D = 2.7\text{ A}$
- Low Profile – 0.8 mm Maximum in the New Package  
MicroFET 2x2 mm
- Free from Halogenated Compounds and Antimony Oxides
- RoHS Compliant

### Applications

- DC–DC Buck Converters

### ABSOLUTE MAXIMUM RATINGS

$T_A = 25^\circ\text{C}$  unless otherwise noted.

Symbol	Parameter	Ratings	Unit
$V_{DS}$	Drain to Source Voltage	100	V
$V_{GS}$	Gate to Source Voltage	$\pm 20$	V
$I_D$	Drain Current Continuous $T_A = 25^\circ\text{C}$ (Note 1a) Pulsed (Note 3)	3.3 20	A
$P_D$	Power Dissipation, $T_A = 25^\circ\text{C}$ (Note 1a) (Note 1b)	2.4 0.9	W
$T_J, T_{STG}$	Operating and Storage Junction Temperature Range	-55 to +150	$^\circ\text{C}$

Stresses exceeding those listed in the Maximum Ratings table may damage the device. If any of these limits are exceeded, device functionality should not be assumed, damage may occur and reliability may be affected.

### THERMAL CHARACTERISTICS

Symbol	Parameter	Ratings	Unit
$R_{\theta JA}$	Thermal Resistance, Junction to Ambient (Note 1a) (Note 1b)	52 145	$^\circ\text{C}/\text{W}$

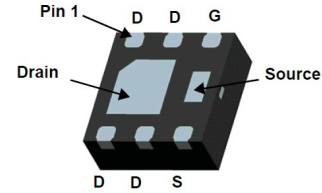

MicroFET 2x2 (Bottom View)

WDFN6 2x2, 0.65P  
CASE 511DB

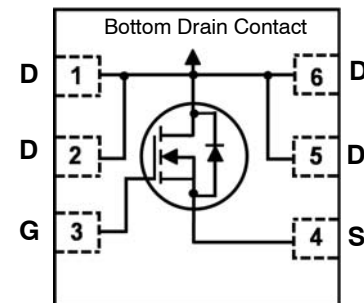

### MARKING DIAGRAM

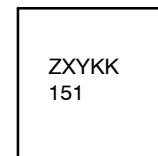

- Z = Assembly Plant Code
- XY = Date Code (Year & Week)
- KK = Lot Traceability Code
- 151 = Specific Device Code

### ORDERING INFORMATION

Device	Package	Shipping†
FDMA86151L	WDFN6	3000 / Tape & Reel

†For information on tape and reel specifications, including part orientation and tape sizes, please refer to our Tape and Reel Packaging Specification Brochure, [BRD8011/D](#).

# FDMA86151L

**ELECTRICAL CHARACTERISTICS**  $T_J = 25^\circ\text{C}$  unless otherwise noted.

Symbol	Parameter	Test Conditions	Min	Typ	Max	Unit
$BV_{DSS}$	Drain to Source Breakdown Voltage	$I_D = 250 \mu\text{A}, V_{GS} = 0 \text{ V}$	100	-	-	V
$\frac{\Delta BV_{DSS}}{\Delta T_J}$	Breakdown Voltage Temperature Coefficient	$I_D = 250 \mu\text{A}$ , Referenced to $25^\circ\text{C}$	-	69	-	mV/ $^\circ\text{C}$
$I_{DSS}$	Zero Gate Voltage Drain Current	$V_{DS} = 80 \text{ V}, V_{GS} = 0 \text{ V}$	-	-	1	$\mu\text{A}$
$I_{GSS}$	Gate to Source Leakage Current	$V_{GS} = \pm 20 \text{ V}, V_{DS} = 0 \text{ V}$	-	-	100	nA

## ON CHARACTERISTICS

$V_{GS(th)}$	Gate to Source Threshold Voltage	$V_{DS} = V_{GS}, I_D = 250 \mu\text{A}$	1.0	2.0	3.0	V
$\frac{\Delta V_{GS(th)}}{\Delta T_J}$	Gate to Source Threshold Voltage Temperature Coefficient	$I_D = 250 \mu\text{A}$ , Referenced to $25^\circ\text{C}$	-	-6	-	mV/ $^\circ\text{C}$
$R_{DS(on)}$	Static Drain to Source On-Resistance	$V_{GS} = 10 \text{ V}, I_D = 3.3 \text{ A}$ ,	-	60	88	m $\Omega$
		$V_{GS} = 4.5 \text{ V}, I_D = 2.7 \text{ A}$	-	83	132	
		$V_{GS} = 10 \text{ V}, I_D = 3.3 \text{ A}$ , $T_J = 125^\circ\text{C}$	-	102	150	
$g_{FS}$	Forward Transconductance	$V_{DD} = 5 \text{ V}, I_D = 3.3 \text{ A}$	-	8.6	-	S

## DYNAMIC CHARACTERISTICS

$C_{iss}$	Input Capacitance	$V_{DS} = 50 \text{ V}, V_{GS} = 0 \text{ V}$ , $f = 1 \text{ MHz}$	-	322	450	pF
$C_{oss}$	Output Capacitance		-	55	80	
$C_{rss}$	Reverse Transfer Capacitance		-	3	5	
$R_G$	Gate Resistance		0.1	1.9	3.8	

## SWITCHING CHARACTERISTICS

$t_{d(on)}$	Turn-On Delay Time	$V_{DD} = 50 \text{ V}, I_D = 3.3 \text{ A}$ , $V_{GS} = 10 \text{ V}, R_{GEN} = 6 \Omega$	-	5.6	12	ns
$t_r$	Rise Time		-	1.4	10	
$t_{d(off)}$	Turn-Off Delay Time		-	11	20	
$t_f$	Fall Time		-	1.6	10	
$Q_{g(TOT)}$	Total Gate Charge	$V_{GS} = 0 \text{ V to } 10 \text{ V}, V_{DD} = 50 \text{ V}$ , $I_D = 3.3 \text{ A}$	-	5.2	7.3	nC
		$V_{GS} = 0 \text{ V to } 4.5 \text{ V}, V_{DD} = 50 \text{ V}$ , $I_D = 3.3 \text{ A}$	-	2.6	3.7	
$Q_{gs}$	Gate to Source Charge	$V_{DD} = 50 \text{ V}, I_D = 3.3 \text{ A}$	-	1.1	-	
$Q_{gd}$	Gate to Drain "Miller" Charge		-	1.0	-	

## DRAIN-SOURCE DIODE CHARACTERISTICS AND MAXIMUM RATINGS

$V_{SD}$	Source to Drain Diode Forward Voltage	$V_{GS} = 0 \text{ V}, I_S = 3.3 \text{ A}$ (Note 2)	-	0.8	1.2	V
$t_{rr}$	Reverse Recovery Time	$I_F = 3.3 \text{ A}, di/dt = 100 \text{ A}/\mu\text{s}$	-	33	53	ns
$Q_{rr}$	Reverse Recovery Charge		-	25	40	nC

Product parametric performance is indicated in the Electrical Characteristics for the listed test conditions, unless otherwise noted. Product performance may not be indicated by the Electrical Characteristics if operated under different conditions.

## NOTES:

- $R_{\theta JA}$  is determined with the device mounted on a 1 in<sup>2</sup> pad 2 oz copper pad on a 1.5 x 1.5 in. board of FR-4 material.  $R_{\theta JC}$  is guaranteed by design while  $R_{\theta JA}$  is determined by the user's board design.

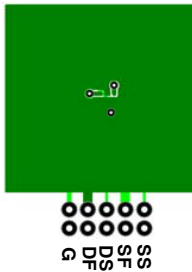

a)  $52^\circ\text{C}/\text{W}$  when mounted on a 1 in<sup>2</sup> pad of 2 oz. copper.



b)  $145^\circ\text{C}/\text{W}$  when mounted on a minimum pad of 2 oz copper.

- Pulse Test: Pulse Width < 300  $\mu\text{s}$ , Duty Cycle < 2.0%
- Pulsed  $I_D$  limited by junction temperature,  $t_d < = 10 \mu\text{s}$ , please refer to SOA curve for more details.

TYPICAL CHARACTERISTICS

( $T_J = 25^\circ\text{C}$  Unless Otherwise Noted)

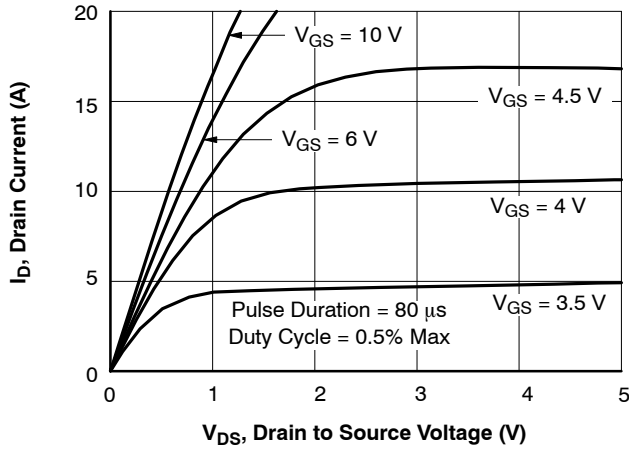

Figure 1. On-Region Characteristics

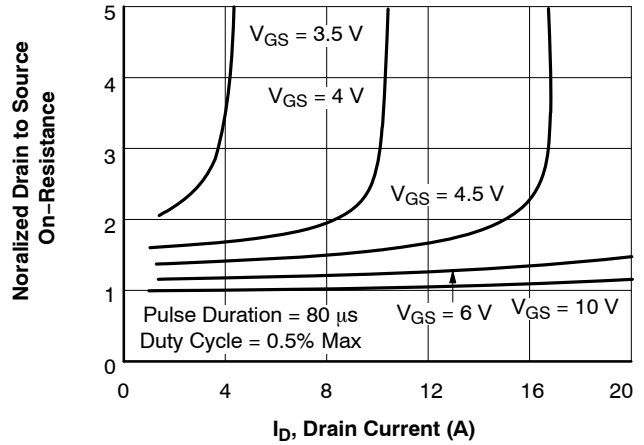

Figure 2. Normalized On-Resistance vs. Drain Current and Gate Voltage

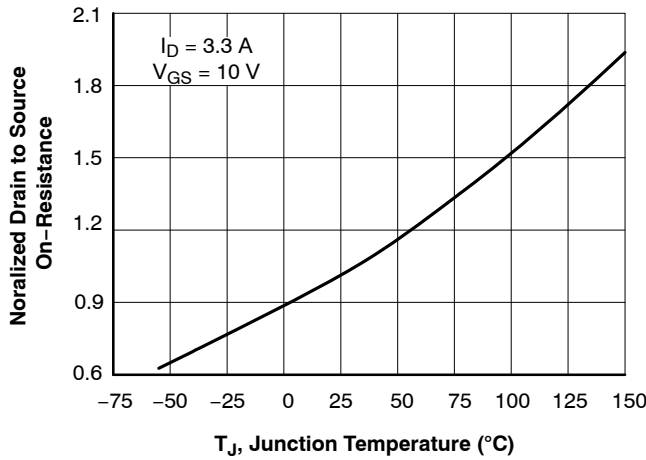

Figure 3. Normalized On-Resistance vs. Junction Temperature

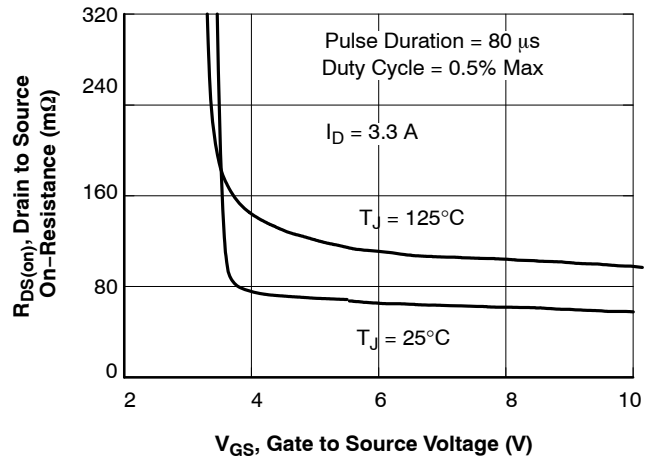

Figure 4. On-Resistance vs. Gate-to-Source Voltage

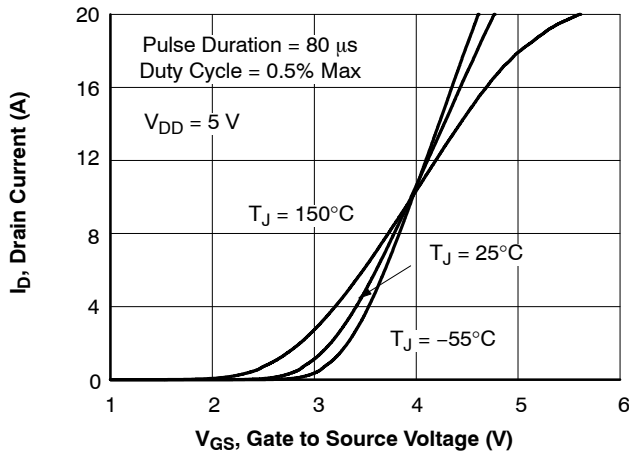

Figure 5. Transfer Characteristics

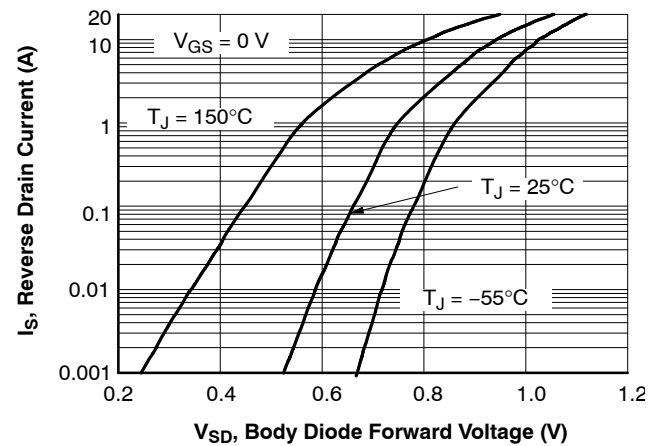

Figure 6. Body Diode Forward Voltage Variation with Source Current and Temperature

# FDMA86151L

## TYPICAL CHARACTERISTICS (Continued)

( $T_J = 25^\circ\text{C}$  Unless Otherwise Noted)

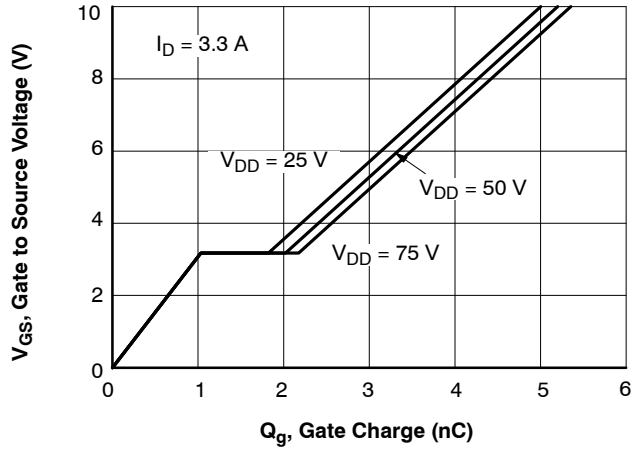

Figure 7. Gate Charge Characteristics

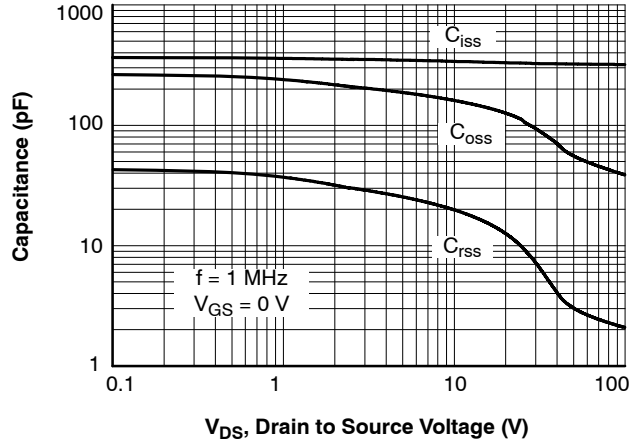

Figure 8. Capacitance vs Drain to Source Voltage

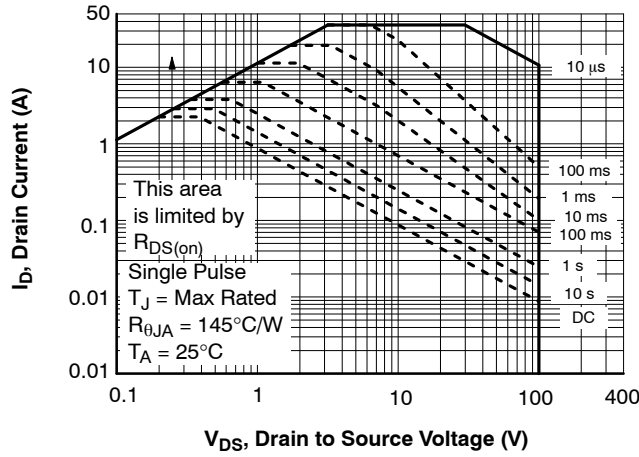

Figure 9. Forward Bias Safe Operating Area

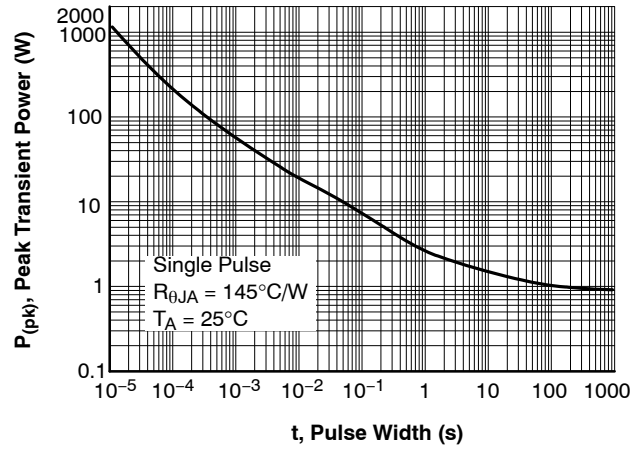

Figure 10. Single Pulse Maximum Power Dissipation

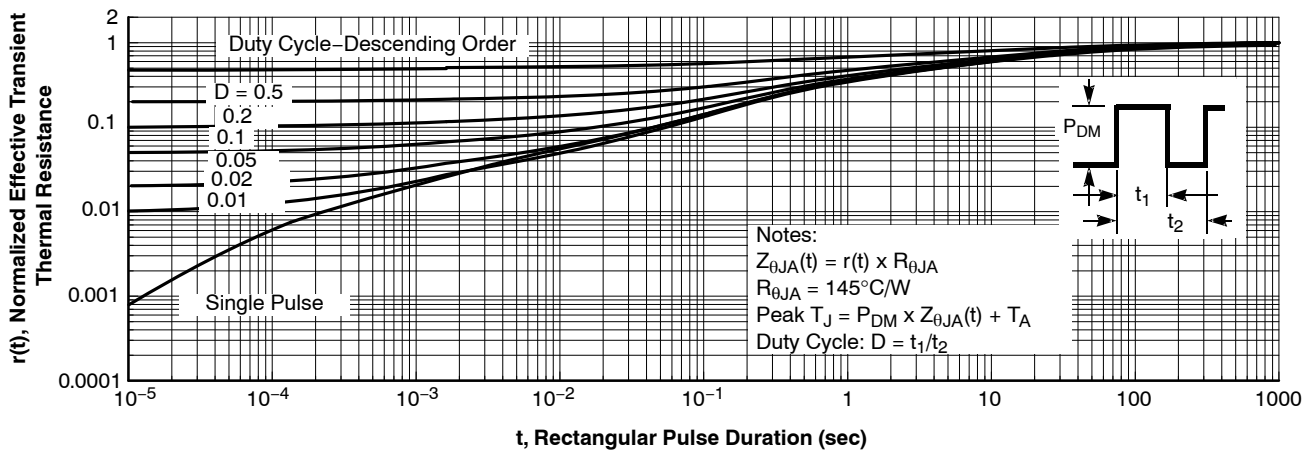

Figure 11. Single Junction-to-Ambient Transient Thermal Response Curve



# MECHANICAL CASE OUTLINE

## PACKAGE DIMENSIONS

ON Semiconductor®



WDFN6 2x2, 0.65P  
CASE 511DB  
ISSUE O

DATE 31 AUG 2016

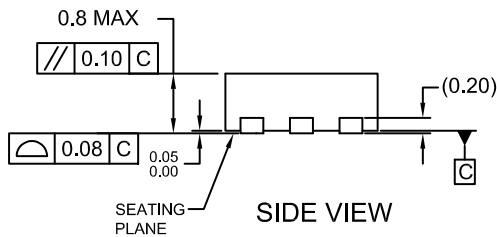
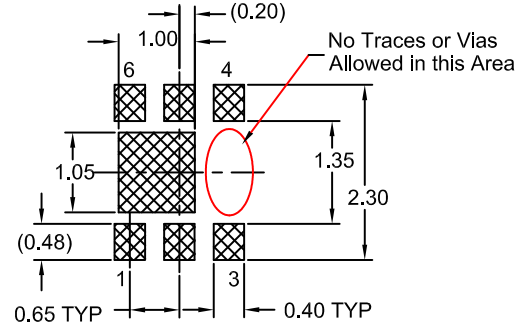
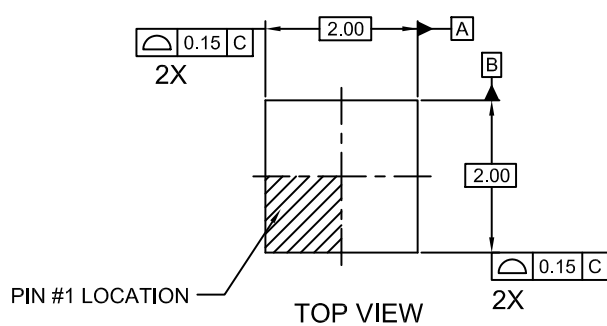

RECOMMENDED LAND PATTERN OPT 1

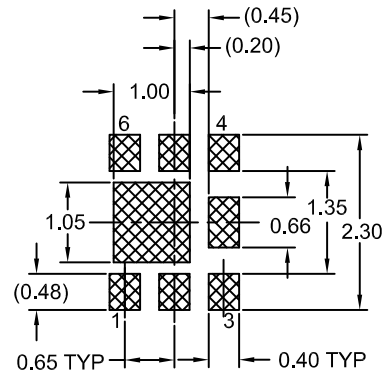
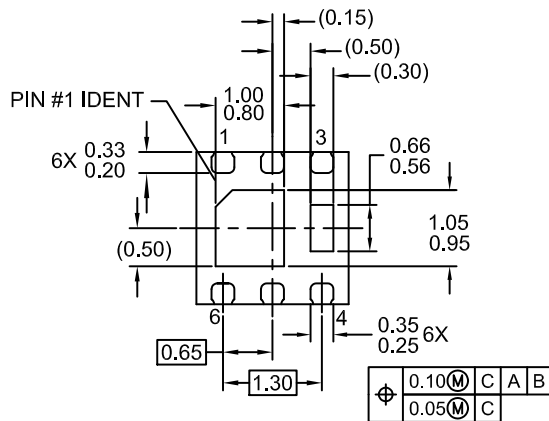

NOTES:

- A. DOES NOT FULLY CONFORM TO JEDEC REGISTRATION MO-229 DATED AUG/2003
- B. DIMENSIONS ARE IN MILLIMETERS.
- C. DIMENSIONS AND TOLERANCES PER ASME Y14.5M, 1994

<b>DOCUMENT NUMBER:</b>	<b>98AON13617G</b>	Electronic versions are uncontrolled except when accessed directly from the Document Repository. Printed versions are uncontrolled except when stamped "CONTROLLED COPY" in red.
<b>DESCRIPTION:</b>	<b>WDFN6 2X2, 0.65P</b>	<b>PAGE 1 OF 1</b>

ON Semiconductor and are trademarks of Semiconductor Components Industries, LLC dba ON Semiconductor or its subsidiaries in the United States and/or other countries. ON Semiconductor reserves the right to make changes without further notice to any products herein. ON Semiconductor makes no warranty, representation or guarantee regarding the suitability of its products for any particular purpose, nor does ON Semiconductor assume any liability arising out of the application or use of any product or circuit, and specifically disclaims any and all liability, including without limitation special, consequential or incidental damages. ON Semiconductor does not convey any license under its patent rights nor the rights of others.

**onsemi**, **Onsemi**, and other names, marks, and brands are registered and/or common law trademarks of Semiconductor Components Industries, LLC dba "**onsemi**" or its affiliates and/or subsidiaries in the United States and/or other countries. **onsemi** owns the rights to a number of patents, trademarks, copyrights, trade secrets, and other intellectual property. A listing of **onsemi**'s product/patent coverage may be accessed at [www.onsemi.com/site/pdf/Patent-Marking.pdf](http://www.onsemi.com/site/pdf/Patent-Marking.pdf). **onsemi** reserves the right to make changes at any time to any products or information herein, without notice. The information herein is provided "as-is" and **onsemi** makes no warranty, representation or guarantee regarding the accuracy of the information, product features, availability, functionality, or suitability of its products for any particular purpose, nor does **onsemi** assume any liability arising out of the application or use of any product or circuit, and specifically disclaims any and all liability, including without limitation special, consequential or incidental damages. Buyer is responsible for its products and applications using **onsemi** products, including compliance with all laws, regulations and safety requirements or standards, regardless of any support or applications information provided by **onsemi**. "Typical" parameters which may be provided in **onsemi** data sheets and/or specifications can and do vary in different applications and actual performance may vary over time. All operating parameters, including "Typicals" must be validated for each customer application by customer's technical experts. **onsemi** does not convey any license under any of its intellectual property rights nor the rights of others. **onsemi** products are not designed, intended, or authorized for use as a critical component in life support systems or any FDA Class 3 medical devices or medical devices with a same or similar classification in a foreign jurisdiction or any devices intended for implantation in the human body. Should Buyer purchase or use **onsemi** products for any such unintended or unauthorized application, Buyer shall indemnify and hold **onsemi** and its officers, employees, subsidiaries, affiliates, and distributors harmless against all claims, costs, damages, and expenses, and reasonable attorney fees arising out of, directly or indirectly, any claim of personal injury or death associated with such unintended or unauthorized use, even if such claim alleges that **onsemi** was negligent regarding the design or manufacture of the part. **onsemi** is an Equal Opportunity/Affirmative Action Employer. This literature is subject to all applicable copyright laws and is not for resale in any manner.

## ADDITIONAL INFORMATION

### TECHNICAL PUBLICATIONS:

Technical Library: [www.onsemi.com/design/resources/technical-documentation](http://www.onsemi.com/design/resources/technical-documentation)  
onsemi Website: [www.onsemi.com](http://www.onsemi.com)

### ONLINE SUPPORT: [www.onsemi.com/support](http://www.onsemi.com/support)

For additional information, please contact your local Sales Representative at [www.onsemi.com/support/sales](http://www.onsemi.com/support/sales)