

MOSFET – Dual, N-Channel, POWERTRENCH®

Q1: 40 V, 156 A, 1.5 mΩ

Q2: 40 V, 156 A, 1.5 mΩ

FDMD8540L

General Description

This device includes two 40 V N-Channel MOSFETs in a dual Power (5 mm x 6 mm) package. HS source and LS drain internally connected for half/full bridge, low source inductance package, low $r_{DS(on)}/Q_g$ FOM silicon.

Features

Q1: N-Channel

- Max $r_{DS(on)}$ = 1.5 mΩ at $V_{GS} = 10$ V, $I_D = 33$ A
- Max $r_{DS(on)}$ = 2.2 mΩ at $V_{GS} = 4.5$ V, $I_D = 26$ A

Q2: N-Channel

- Max $r_{DS(on)}$ = 1.5 mΩ at $V_{GS} = 10$ V, $I_D = 33$ A
- Max $r_{DS(on)}$ = 2.2 mΩ at $V_{GS} = 4.5$ V, $I_D = 26$ A

- Ideal for Flexible Layout in Primary Side of Bridge Topology
- 100% UIL Tested
- Kelvin High Side MOSFET Drive Pin-out Capability
- This Device is Pb-Free and are RoHS Compliant

Applications

- POL Synchronous Dual
- One Phase Motor Half Bridge
- Half/Full Bridge Secondary Synchronous Rectification



ON Semiconductor®

www.onsemi.com

| V_{DS} | $r_{DS(on)}$ MAX | I_D MAX |
|----------|------------------|-----------|
| 40 V | 1.5 mΩ @ 10 V | 156 A |
| | 2.2 mΩ @ 4.5 V | |

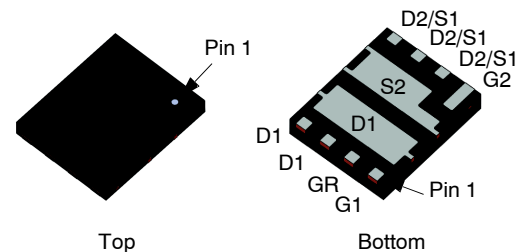

PQFN8 5X6, 1.27P
Power 5 x 6
CASE 483AT

MARKING DIAGRAM

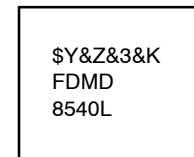

FDMD8540L = Specific Device Code
 \$Y = ON Semiconductor Logo
 &Z = Assembly Plant Code
 &3 = 3-Digit Date Code Format
 &K = 2-Digits Lot Run Traceability Data

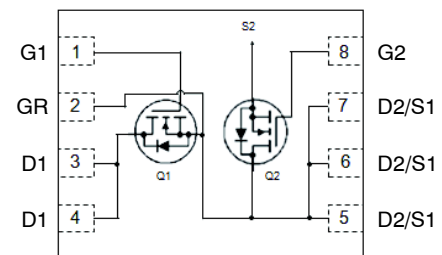

ORDERING INFORMATION

See detailed ordering and shipping information on page 9 of this data sheet.

FDMD8540L

MOSFET MAXIMUM RATINGS ($T_A = 25^\circ\text{C}$ unless otherwise noted)

| Symbol | Parameter | Q1 | Q2 | Unit | | |
|----------------|--|--------------------------|------------------------------------|------------------|--------------|---|
| V_{DS} | Drain to Source Voltage | 40 | 40 | V | | |
| V_{GS} | Gate to Source Voltage | ± 20 | ± 20 | V | | |
| I_D | Drain Current | - Continuous | $T_C = 25^\circ\text{C}$ (Note 3) | 156 | 156 | A |
| | | - Continuous | $T_C = 100^\circ\text{C}$ (Note 3) | 99 | 99 | |
| | | - Continuous | $T_A = 25^\circ\text{C}$ | 33 (Note 4a) | 33 (Note 4b) | |
| | | - Pulsed | (Note 2) | 886 | 886 | |
| E_{AS} | Single Pulse Avalanche Energy (Note 1) | 541 | 541 | mJ | | |
| P_D | Power Dissipation | $T_C = 25^\circ\text{C}$ | 62 | 62 | W | |
| | Power Dissipation | $T_A = 25^\circ\text{C}$ | 2.3 (Note 4a) | 2.3 (Note 4b) | | |
| T_J, T_{STG} | Operating and Storage Junction Temperature Range | -55 to +150 | | $^\circ\text{C}$ | | |

Stresses exceeding those listed in the Maximum Ratings table may damage the device. If any of these limits are exceeded, device functionality should not be assumed, damage may occur and reliability may be affected.

- Q1: E_{AS} of 541 mJ is based on starting $T_J = 25^\circ\text{C}$, $L = 3$ mH, $I_{AS} = 19$ A, $V_{DD} = 40$ V, $V_{GS} = 10$ V. 100% tested at $L = 0.1$ mH, $I_{AS} = 59$ A.
Q2: E_{AS} of 541 mJ is based on starting $T_J = 25^\circ\text{C}$, $L = 3$ mH, $I_{AS} = 19$ A, $V_{DD} = 40$ V, $V_{GS} = 10$ V. 100% tested at $L = 0.1$ mH, $I_{AS} = 59$ A.
- Pulsed I_D please refer to Figure 11 and Figure 24 SOA graph for more details.
- Computed continuous current limited to Max Junction Temperature only, actual continuous current will be limited by thermal & electro-mechanical application board design.

THERMAL CHARACTERISTICS

| Symbol | Parameter | Q1 | Q2 | Unit |
|-----------------|---|--------------|--------------|---------------------------|
| $R_{\theta JC}$ | Thermal Resistance, Junction-to-Case | 2.0 | 2.0 | $^\circ\text{C}/\text{W}$ |
| $R_{\theta JA}$ | Thermal Resistance, Junction-to-Ambient | 55 (Note 4a) | 55 (Note 4b) | |

- $R_{\theta JA}$ is determined with the device mounted on a 1 in² pad 2 oz copper pad on a 1.5 x 1.5 in. board of FR-4 material. $R_{\theta JC}$ is guaranteed by design while $R_{\theta CA}$ is determined by the user's board design.

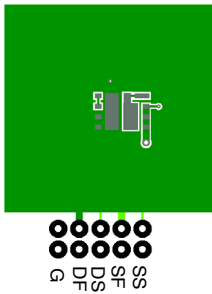

a. $55^\circ\text{C}/\text{W}$ when mounted on a 1 in² pad of 2 oz copper

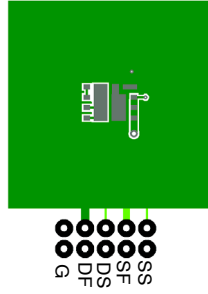

b. $55^\circ\text{C}/\text{W}$ when mounted on a 1 in² pad of 2 oz copper

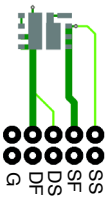

c. $155^\circ\text{C}/\text{W}$ when mounted on a minimum pad of 2 oz copper



d. $155^\circ\text{C}/\text{W}$ when mounted on a minimum pad of 2 oz copper

FDMD8540L

ELECTRICAL CHARACTERISTICS (T_J = 25°C unless otherwise noted)

| Symbol | Parameter | Test Condition | Type | Min | Typ | Max | Unit |
|--------|-----------|----------------|------|-----|-----|-----|------|
|--------|-----------|----------------|------|-----|-----|-----|------|

OFF CHARACTERISTICS

| | | | | | | | |
|--------------------------------------|---|--|----------|----------|----------|--------------|-------|
| BV _{DSS} | Drain to Source Breakdown Voltage | I _D = 250 μA, V _{GS} = 0 V | Q1 Q2 | 40 40 | – – | – – | V |
| $\frac{\Delta BV_{DSS}}{\Delta T_J}$ | Breakdown Voltage Temperature Coefficient | I _D = 250 mA, referenced to 25°C | Q1 Q2 | – – | 20 20 | – – | mV/°C |
| I _{DSS} | Zero Gate Voltage Drain Current | V _{DS} = 32 V, V _{GS} = 0 V | Q1 Q2 | – – | – – | 1 1 | μA |
| I _{GSS} | Gate to Source Leakage Current | V _{GS} = ±20 V, V _{DS} = 0 V | Q1 Q2 | – – | – – | ±100 ±100 | nA |

ON CHARACTERISTICS

| | | | | | | | |
|--|--|---|----------|------------|------------|------------|-------|
| V _{GS(th)} | Gate to Source Threshold Voltage | V _{GS} = V _{DS} , I _D = 250 mA | Q1 Q2 | 1.0 1.0 | 1.8 1.8 | 3.0 3.0 | V |
| $\frac{\Delta V_{GS(th)}}{\Delta T_J}$ | Gate to Source Threshold Voltage Temperature Coefficient | I _D = 250 μA, referenced to 25°C | Q1 Q2 | – – | –6 –6 | – – | mV/°C |
| r _{DS(on)} | Static Drain to Source On Resistance | V _{GS} = 10 V, I _D = 33 A | Q1 | – | 1.25 | 1.5 | mΩ |
| | | V _{GS} = 4.5 V, I _D = 26 A | | – | 1.65 | 2.2 | |
| | | V _{GS} = 10 V, I _D = 33 A, T _J = 125°C | | – | 1.7 | 2.1 | |
| | | V _{GS} = 10 V, I _D = 33 A | Q2 | – | 1.25 | 1.5 | |
| | | V _{GS} = 4.5 V, I _D = 26 A | | – | 1.65 | 2.2 | |
| | | V _{GS} = 10 V, I _D = 33 A, T _J = 125°C | | – | 1.7 | 2.1 | |
| g _{FS} | Forward Transconductance | V _{DD} = 5 V, I _D = 33 A | Q1 Q2 | – – | 178 178 | – – | S |

DYNAMIC CHARACTERISTICS

| | | | | | | | |
|------------------|------------------------------|--|----------|------------|--------------|--------------|----|
| C _{iss} | Input Capacitance | V _{DS} = 20 V, V _{GS} = 0 V f = 1 MHz | Q1 Q2 | – – | 5670 5670 | 7940 7940 | pF |
| C _{oss} | Output Capacitance | | Q1 Q2 | – – | 1668 1668 | 2335 2335 | pF |
| C _{rss} | Reverse Transfer Capacitance | | Q1 Q2 | – – | 75 75 | 135 135 | pF |
| R _g | Gate Resistance | | Q1 Q2 | 0.1 0.1 | 1.6 1.6 | 3.2 3.2 | Ω |

SWITCHING CHARACTERISTICS

| | | | | | | | | |
|---------------------|-------------------------------|---|--|----------|--------|----------|------------|----|
| t _{d(on)} | Turn-On Delay Time | V _{DD} = 20 V, I _D = 33 A V _{GS} = 10 V, R _{GEN} = 6 Ω | | Q1 Q2 | – – | 15 15 | 28 28 | ns |
| t _r | Rise Time | | | Q1 Q2 | – – | 13 13 | 24 24 | ns |
| t _{d(off)} | Turn-Off Delay Time | | | Q1 Q2 | – – | 51 51 | 81 81 | ns |
| t _f | Fall Time | | | Q1 Q2 | – – | 14 14 | 25 25 | ns |
| Q _{g(TOT)} | Total Gate Charge | V _{GS} = 0 V to 10 V | V _{DD} = 20 V, I _D = 33 A | Q1 Q2 | – – | 81 81 | 113 113 | nC |
| Q _{g(TOT)} | Total Gate Charge | V _{GS} = 0 V to 4.5 V | V _{DD} = 20 V, I _D = 33 A | Q1 Q2 | – – | 38 38 | 54 54 | nC |
| Q _{gs} | Gate to Source Charge | V _{DD} = 20 V, I _D = 33 A | | Q1 Q2 | – – | 15 15 | – – | nC |
| Q _{gd} | Gate to Drain "Miller" Charge | V _{DD} = 20 V, I _D = 33 A | | Q1 Q2 | – – | 11 11 | – – | nC |

FDMD8540L

ELECTRICAL CHARACTERISTICS ($T_J = 25^\circ\text{C}$ unless otherwise noted) (continued)

| Symbol | Parameter | Test Condition | Type | Min | Typ | Max | Unit |
|---|---------------------------------------|--|----------|--------|------------|------------|------|
| DRAIN-SOURCE DIODE CHARACTERISTICS | | | | | | | |
| V_{SD} | Source to Drain Diode Forward Voltage | $V_{GS} = 0\text{ V}$, $I_S = 33\text{ A}$ (Note 5) | Q1 Q2 | - - | 0.8 0.8 | 1.3 1.3 | V |
| V_{SD} | Source to Drain Diode Forward Voltage | $V_{GS} = 0\text{ V}$, $I_S = 2\text{ A}$ (Note 5) | Q1 Q2 | - - | 0.7 0.7 | 1.2 1.2 | V |
| t_{rr} | Reverse Recovery Time | $I_F = 33\text{ A}$, $di/dt = 100\text{ A}/\mu\text{s}$ | Q1 Q2 | - - | 54 54 | 86 86 | ns |
| Q_{rr} | Reverse Recovery Charge | | Q1 Q2 | - - | 38 38 | 60 60 | nC |

Product parametric performance is indicated in the Electrical Characteristics for the listed test conditions, unless otherwise noted. Product performance may not be indicated by the Electrical Characteristics if operated under different conditions.

5. Pulse Test: Pulse Width < 300 μs , Duty cycle < 2.0 %.

TYPICAL CHARACTERISTICS (Q1 N-CHANNEL)

($T_J = 25^\circ\text{C}$ unless otherwise noted)

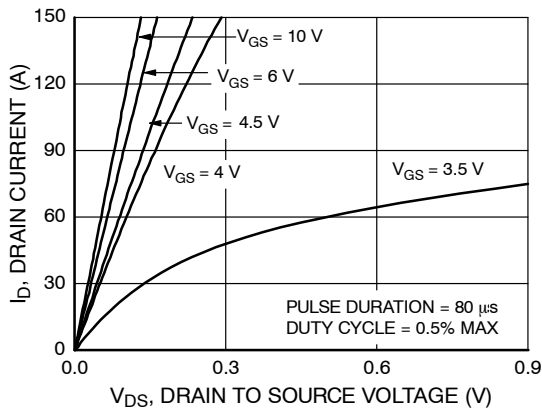

Figure 1. On Region Characteristics

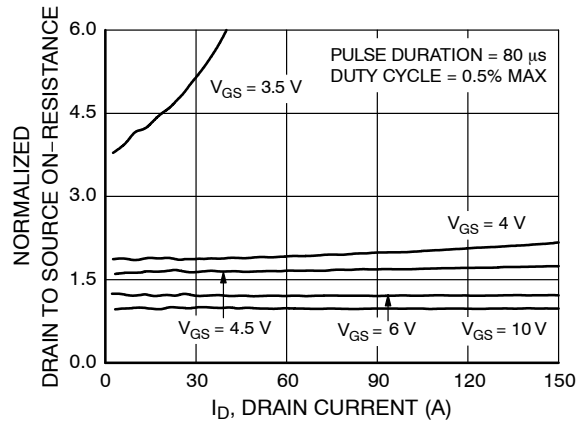

Figure 2. Normalized On-Resistance vs. Drain Current and Gate Voltage

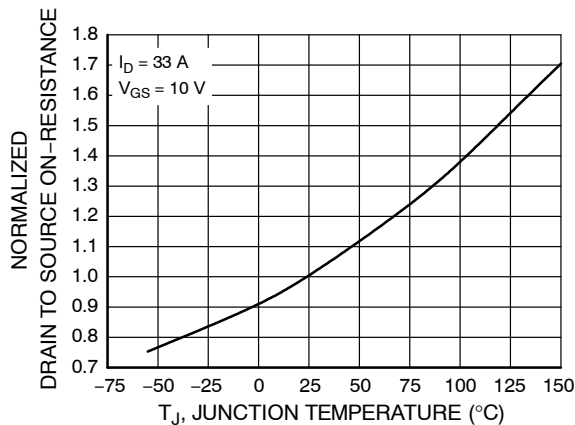

Figure 3. Normalized On Resistance vs. Junction Temperature

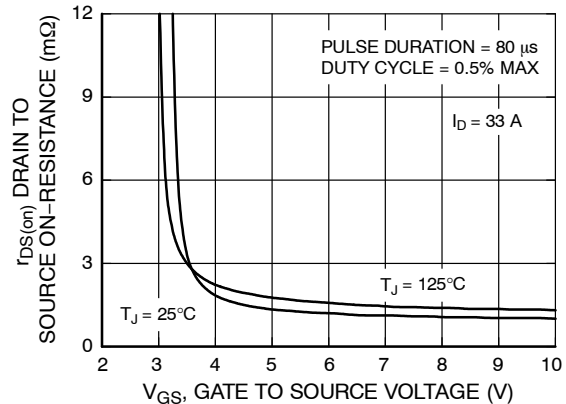

Figure 4. On-Resistance vs. Gate to Source Voltage

FDMD8540L

TYPICAL CHARACTERISTICS (Q1 N-CHANNEL)

($T_J = 25^\circ\text{C}$ unless otherwise noted) (continued)

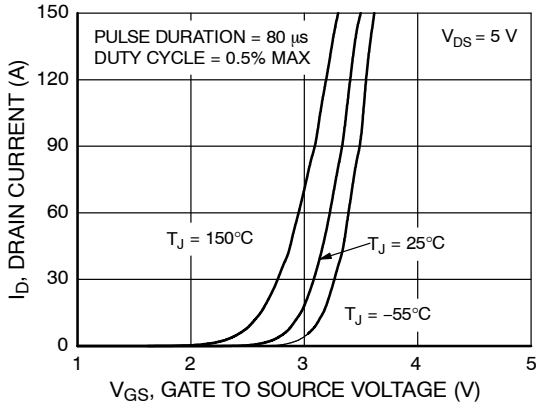

Figure 5. Transfer Characteristics

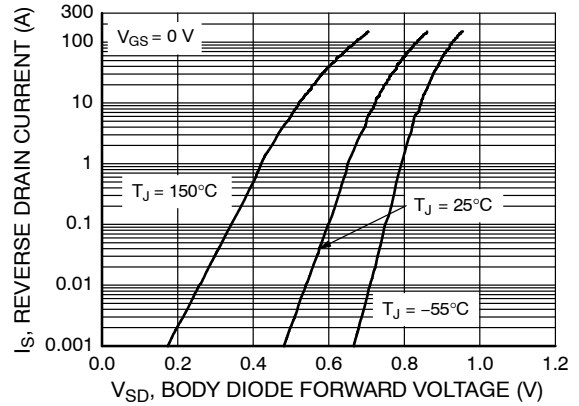

Figure 6. Source to Gate Diode Forward Voltage vs. Source Current

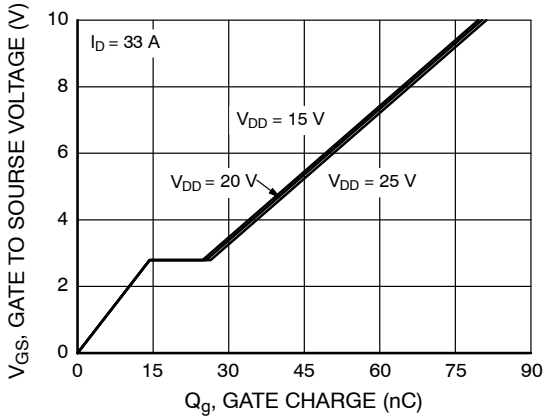

Figure 7. Gate Charge Characteristics

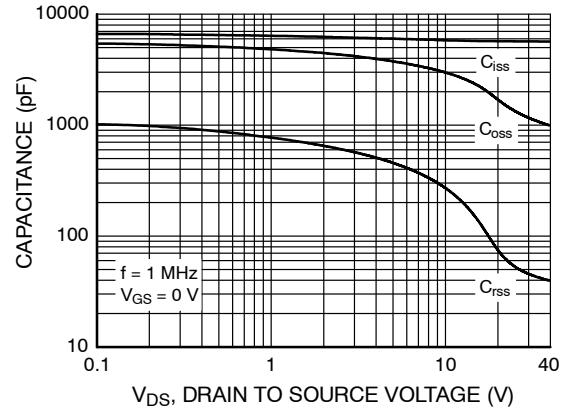

Figure 8. Capacitance vs. Drain to Source Voltage

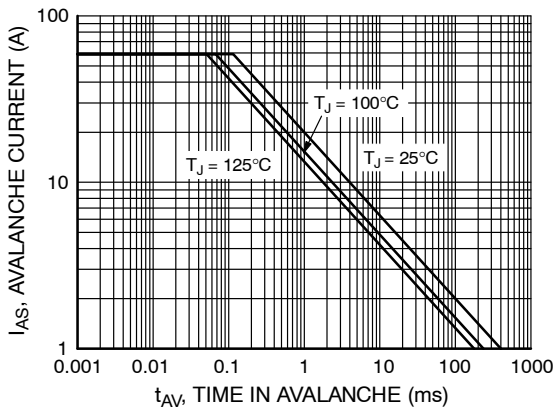

Figure 9. Unclamped Inductive Switching Capability

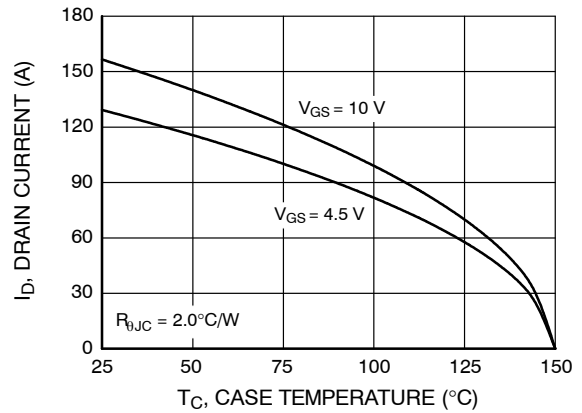

Figure 10. Maximum Continuous Drain Current vs. Case Temperature

FDMD8540L

TYPICAL CHARACTERISTICS (Q1 N-CHANNEL)

($T_J = 25^\circ\text{C}$ unless otherwise noted) (continued)

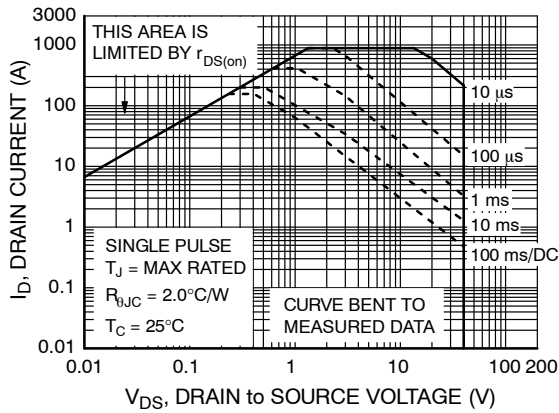

Figure 11. Forward Bias Safe Operating Area

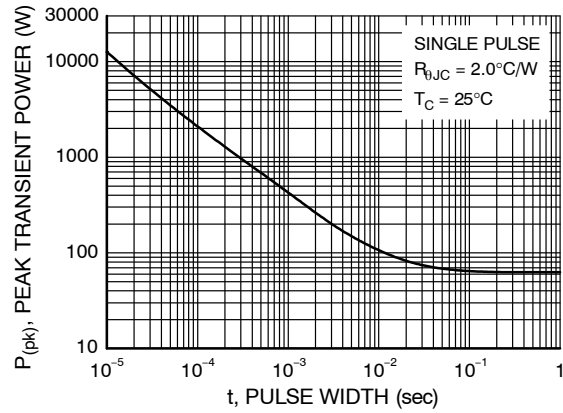

Figure 12. Single Pulse Maximum Power Dissipation

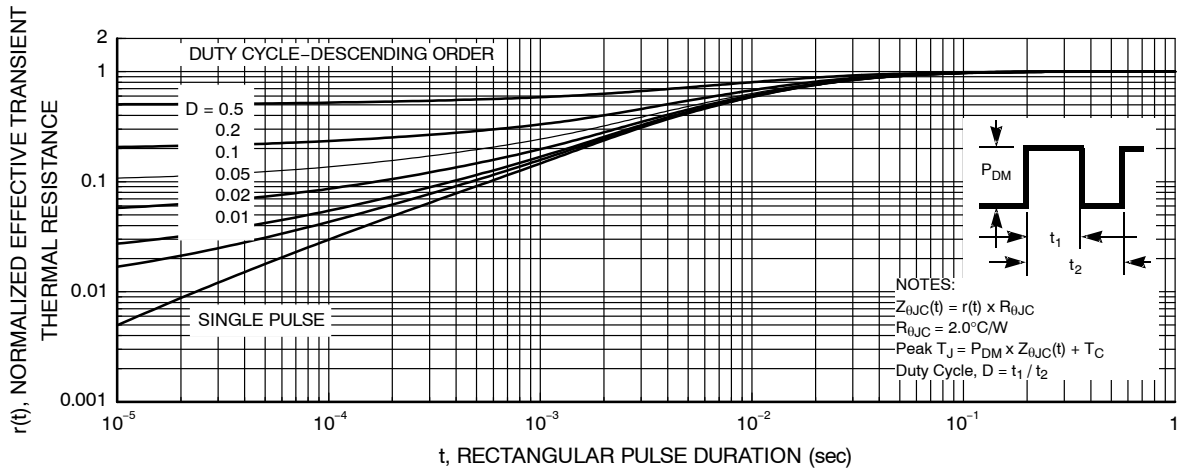

Figure 13. Junction-to-Case Transient Thermal Response Curve

FDMD8540L

TYPICAL CHARACTERISTICS (Q2 N-CHANNEL)

($T_J = 25^\circ\text{C}$ unless otherwise noted)

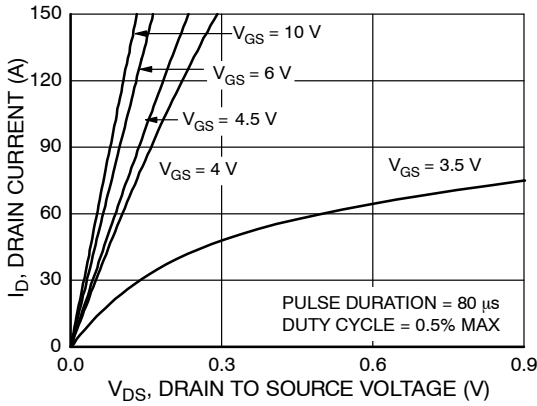

Figure 14. On-Region Characteristics

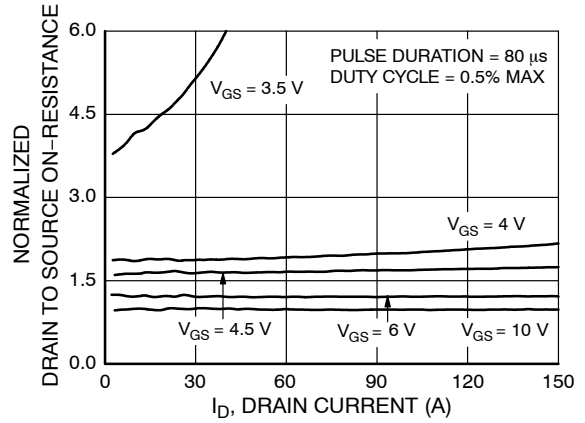

Figure 15. Normalized On-Resistance vs. Drain Current and Gate Voltage

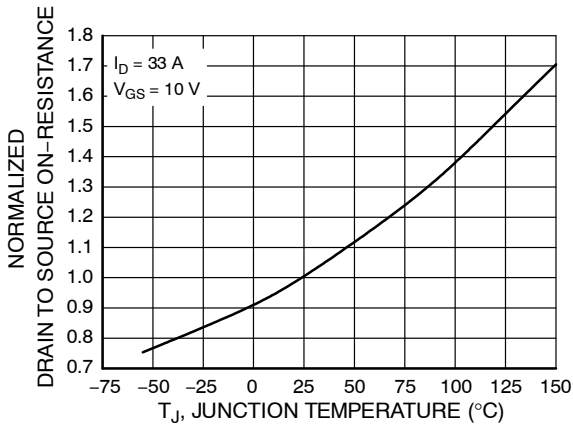

Figure 16. Normalized On Resistance vs. Junction Temperature

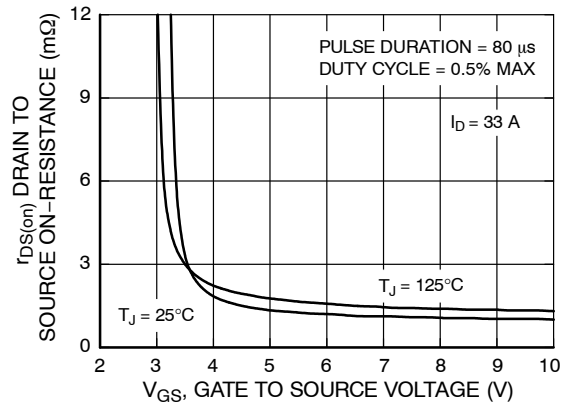

Figure 17. On-Resistance vs. Gate to Source Voltage

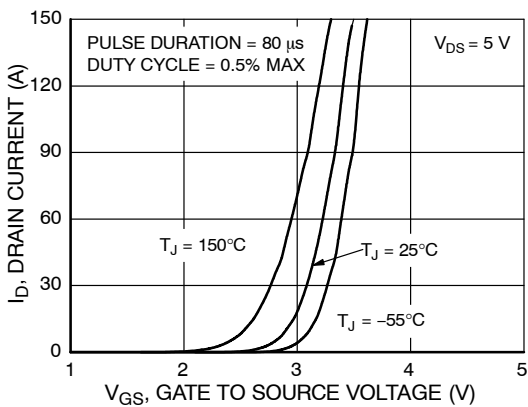

Figure 18. Transfer Characteristics

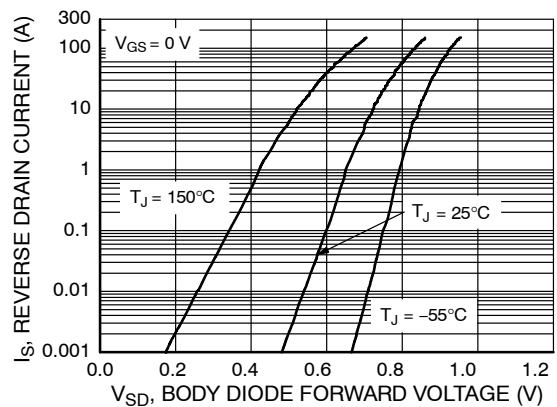

Figure 19. Source to Gate Diode Forward Voltage vs. Source Current

TYPICAL CHARACTERISTICS (Q2 N-CHANNEL)

($T_J = 25^\circ\text{C}$ unless otherwise noted) (continued)

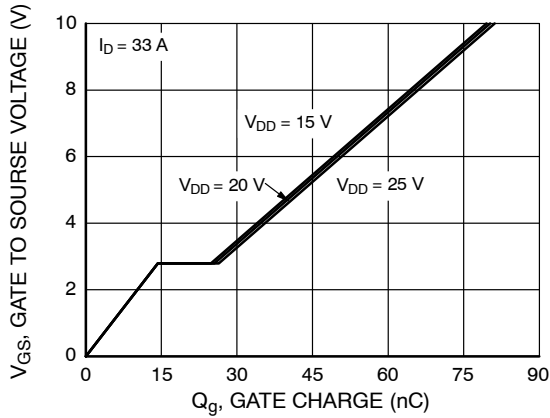

Figure 20. Gate Charge Characteristics

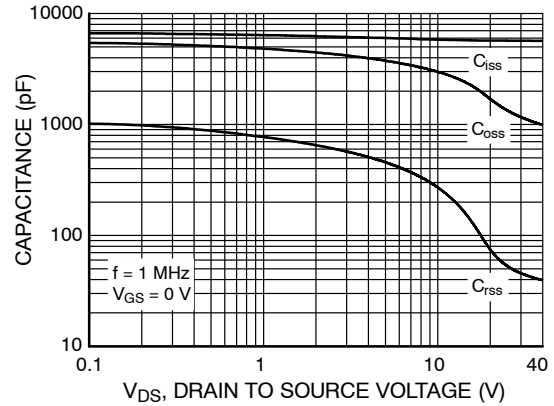

Figure 21. Capacitance vs. Drain to Source Voltage

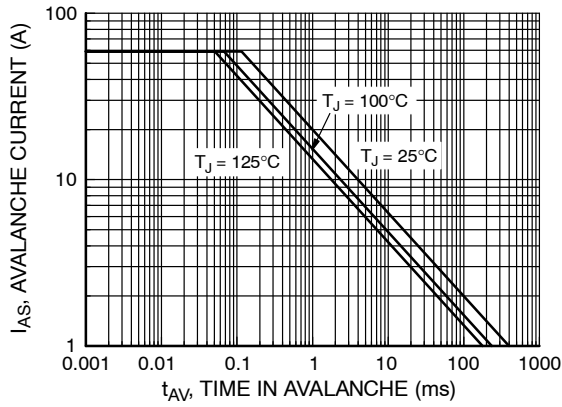

Figure 22. Unclamped Inductive Switching Capability

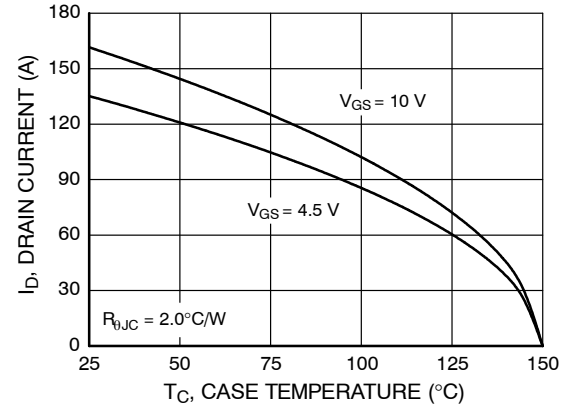

Figure 23. Maximum Continuous Drain Current vs. Case Temperature

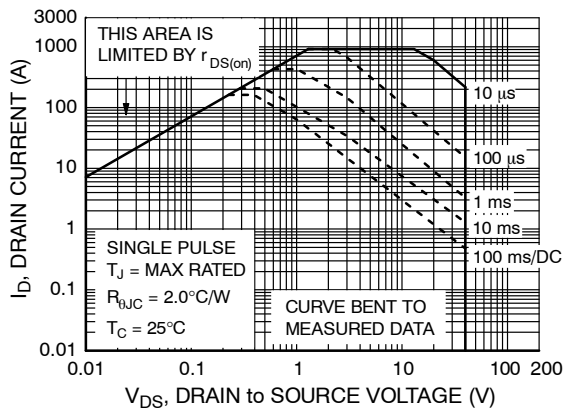

Figure 24. Forward Bias Safe Operating Area

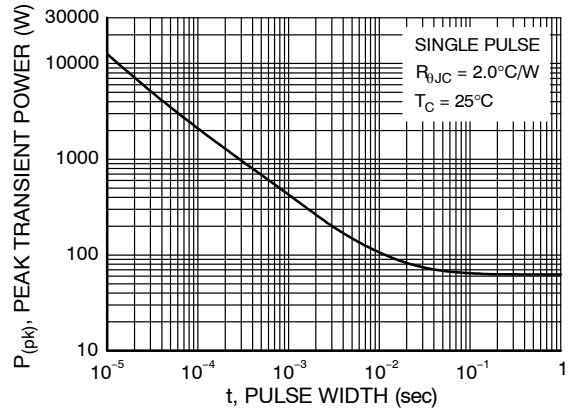

Figure 25. Single Pulse Maximum Power Dissipation

FDMD8540L

TYPICAL CHARACTERISTICS (Q2 N-CHANNEL)

($T_J = 25^\circ\text{C}$ unless otherwise noted) (continued)

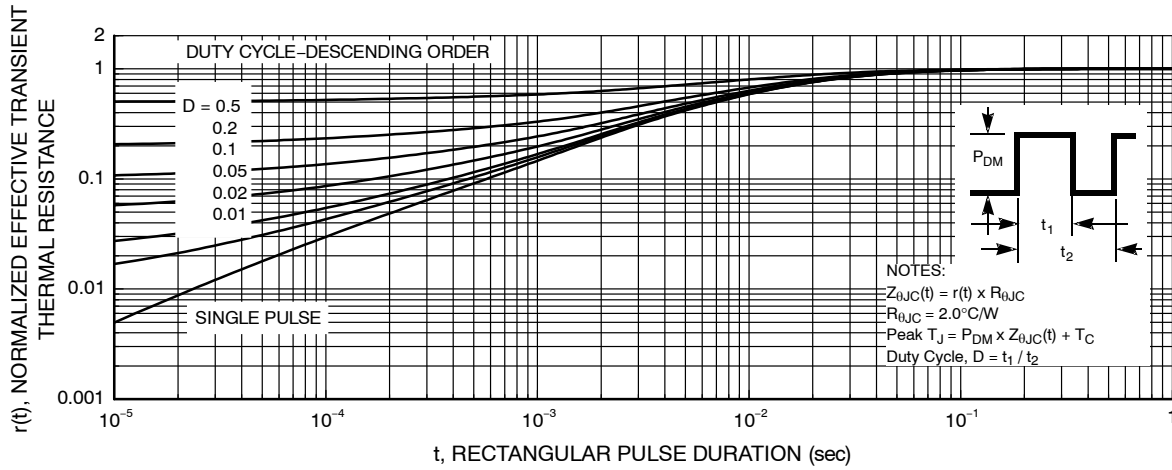

Figure 26. Junction-to-Case Transient Thermal Response Curve

PACKAGE MARKING AND ORDERING INFORMATION

| Device Marking | Device | Package Type | Reel Size | Tape Width | Shipping [†] |
|----------------|-----------|--|-----------|------------|-----------------------|
| FDMD8540L | FDMD8540L | PQFN8 5X6, 1.27P Power 5 x 6 (Pb-Free) | 13" | 12 mm | 3000 / Tape & Reel |

[†]For information on tape and reel specifications, including part orientation and tape sizes, please refer to our Tape and Reel Packaging Specifications Brochure, BRD8011/D.

POWERTRENCH is registered trademark of Semiconductor Components Industries, LLC (SCILLC) or its subsidiaries in the United States and/or other countries.

MECHANICAL CASE OUTLINE PACKAGE DIMENSIONS

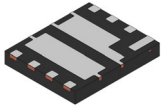

PQFN8 5X6, 1.27P CASE 483AT ISSUE B

DATE 28 APR 2021

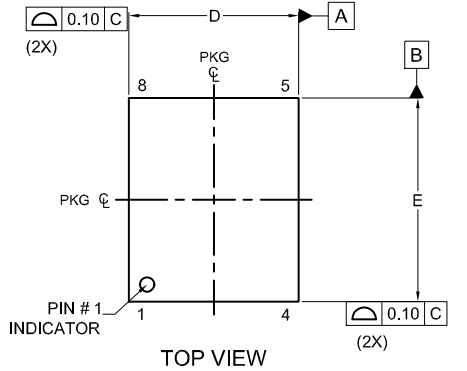

TOP VIEW

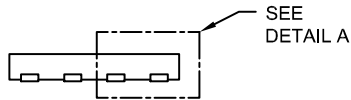

SIDE VIEW

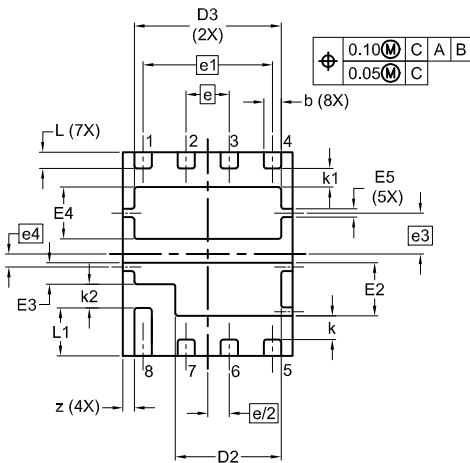

BOTTOM VIEW

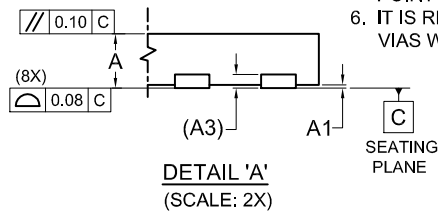

DETAIL 'A'
(SCALE: 2X)

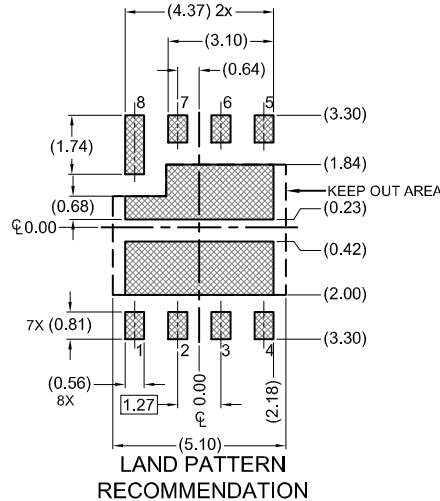

LAND PATTERN
RECOMMENDATION

NOTES:

1. DIMENSIONING AND TOLERANCING PER ASME Y14.5M, 2009.
2. CONTROLLING DIMENSION: MILLIMETERS
3. COPLANARITY APPLIES TO THE EXPOSED PADS AS WELL AS THE TERMINALS.
4. DIMENSIONS D1 AND E1 DO NOT INCLUDE MOLD FLASH, PROTRUSIONS, OR GATE BURRS.
5. SEATING PLANE IS DEFINED BY THE TERMINALS. "A1" IS DEFINED AS THE DISTANCE FROM THE SEATING PLANE TO THE LOWEST POINT ON THE PACKAGE BODY.
6. IT IS RECOMMENDED TO HAVE NO TRACES OR VIAS WITHIN THE KEEP OUT AREA.

| DIM | MILLIMETERS | | |
|-----|-------------|------|------|
| | MIN. | NOM. | MAX. |
| A | 0.70 | 0.75 | 0.80 |
| A1 | 0.00 | - | 0.05 |
| A3 | 0.20 REF | | |
| b | 0.41 | 0.51 | 0.61 |
| D | 4.90 | 5.00 | 5.10 |
| D2 | 3.01 | 3.11 | 3.21 |
| D3 | 4.22 | 4.32 | 4.42 |
| E | 5.90 | 6.00 | 6.10 |
| E2 | 1.47 | 1.57 | 1.67 |
| E3 | 0.53 | 0.63 | 0.73 |
| E4 | 1.42 | 1.52 | 1.62 |
| E5 | 0.20 | 0.25 | 0.30 |
| e | 1.27 BSC | | |
| e1 | 3.81 BSC | | |
| e/2 | 0.64 BSC | | |
| e3 | 1.08 BSC | | |
| e4 | 0.25 BSC | | |
| k | 0.60 | 0.70 | 0.80 |
| k1 | 0.45 | 0.55 | 0.65 |
| k2 | 0.60 | 0.70 | 0.80 |
| L | 0.38 | 0.48 | 0.58 |
| L1 | 1.31 | 1.41 | 1.51 |
| z | 0.34 REF | | |

*FOR ADDITIONAL INFORMATION ON OUR PB-FREE STRATEGY AND SOLDERING DETAILS, PLEASE DOWNLOAD THE ON SEMICONDUCTOR SOLDERING AND MOUNTING TECHNIQUES REFERENCE MANUAL, SOLDERRM/D.

| | | |
|------------------|------------------|--|
| DOCUMENT NUMBER: | 98AON13668G | Electronic versions are uncontrolled except when accessed directly from the Document Repository. Printed versions are uncontrolled except when stamped "CONTROLLED COPY" in red. |
| DESCRIPTION: | PQFN8 5X6, 1.27P | PAGE 1 OF 1 |

onsemi and ONSEMI are trademarks of Semiconductor Components Industries, LLC dba onsemi or its subsidiaries in the United States and/or other countries. onsemi reserves the right to make changes without further notice to any products herein. onsemi makes no warranty, representation or guarantee regarding the suitability of its products for any particular purpose, nor does onsemi assume any liability arising out of the application or use of any product or circuit, and specifically disclaims any and all liability, including without limitation special, consequential or incidental damages. onsemi does not convey any license under its patent rights nor the rights of others.

onsemi, **Onsemi**, and other names, marks, and brands are registered and/or common law trademarks of Semiconductor Components Industries, LLC dba "**onsemi**" or its affiliates and/or subsidiaries in the United States and/or other countries. **onsemi** owns the rights to a number of patents, trademarks, copyrights, trade secrets, and other intellectual property. A listing of **onsemi**'s product/patent coverage may be accessed at www.onsemi.com/site/pdf/Patent-Marking.pdf. **onsemi** reserves the right to make changes at any time to any products or information herein, without notice. The information herein is provided "as-is" and **onsemi** makes no warranty, representation or guarantee regarding the accuracy of the information, product features, availability, functionality, or suitability of its products for any particular purpose, nor does **onsemi** assume any liability arising out of the application or use of any product or circuit, and specifically disclaims any and all liability, including without limitation special, consequential or incidental damages. Buyer is responsible for its products and applications using **onsemi** products, including compliance with all laws, regulations and safety requirements or standards, regardless of any support or applications information provided by **onsemi**. "Typical" parameters which may be provided in **onsemi** data sheets and/or specifications can and do vary in different applications and actual performance may vary over time. All operating parameters, including "Typicals" must be validated for each customer application by customer's technical experts. **onsemi** does not convey any license under any of its intellectual property rights nor the rights of others. **onsemi** products are not designed, intended, or authorized for use as a critical component in life support systems or any FDA Class 3 medical devices or medical devices with a same or similar classification in a foreign jurisdiction or any devices intended for implantation in the human body. Should Buyer purchase or use **onsemi** products for any such unintended or unauthorized application, Buyer shall indemnify and hold **onsemi** and its officers, employees, subsidiaries, affiliates, and distributors harmless against all claims, costs, damages, and expenses, and reasonable attorney fees arising out of, directly or indirectly, any claim of personal injury or death associated with such unintended or unauthorized use, even if such claim alleges that **onsemi** was negligent regarding the design or manufacture of the part. **onsemi** is an Equal Opportunity/Affirmative Action Employer. This literature is subject to all applicable copyright laws and is not for resale in any manner.

ADDITIONAL INFORMATION

TECHNICAL PUBLICATIONS:

Technical Library: www.onsemi.com/design/resources/technical-documentation
onsemi Website: www.onsemi.com

ONLINE SUPPORT: www.onsemi.com/support

For additional information, please contact your local Sales Representative at www.onsemi.com/support/sales

