

# FDMD8630

## MOSFET – N-Channel, POWERTRENCH<sup>®</sup>, Dual

30 V, 167 A, 1.0 mΩ

### General Description

This package integrates two N-Channel devices connected internally in common-source configuration. This enables very low package parasitics and optimized thermal path to the common source pad on the bottom. Provides a very small footprint (5 x 6 mm) for higher power density.

### Features

- Common Source Configuration to Eliminate PCB Routing
- Large Source Pad on Bottom of Package for Enhanced Thermals
- Max  $r_{DS(on)} = 1.0\text{ m}\Omega$  at  $V_{GS} = 10\text{ V}$ ,  $I_D = 38\text{ A}$
- Max  $r_{DS(on)} = 1.3\text{ m}\Omega$  at  $V_{GS} = 4.5\text{ V}$ ,  $I_D = 33\text{ A}$
- Ideal for Flexible Layout in Secondary Side Synchronous Rectification
- 100% UIL Tested
- This Device is Pb-Free and is RoHS Compliant

### Applications

- Isolated DC-DC Synchronous Rectifiers
- Common Ground Load Switches



ON Semiconductor<sup>®</sup>

[www.onsemi.com](http://www.onsemi.com)

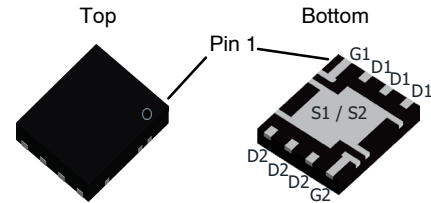

PQFN8 5X6, 1.27P  
CASE 483AS

### MARKING DIAGRAM

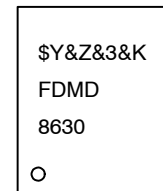

&Y = ON Semiconductor Logo  
&Z = Assembly Plant Code  
&3 = Numeric Date Code  
&K = Lot Code  
FDMD8630 = Specific Device Code

### PIN CONFIGURATION

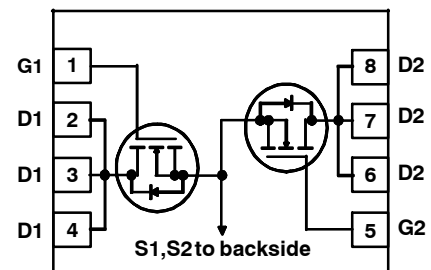

### ORDERING INFORMATION

See detailed ordering and shipping information on page 2 of this data sheet.

# FDMD8630

## MOSFET MAXIMUM RATINGS $T_A = 25^\circ\text{C}$ Unless Otherwise Noted

Symbol	Parameter	Ratings	Units
$V_{DS}$	Drain to Source Voltage	30	V
$V_{GS}$	Gate to Source Voltage	$\pm 20$	V
$I_D$	Drain Current – Continuous – $T_C = 25^\circ\text{C}$ (Note 5)	167	A
	– Continuous – $T_C = 100^\circ\text{C}$ (Note 5)	106	
	– Continuous – $T_A = 25^\circ\text{C}$ (Note 1a)	38	
	– Pulsed – (Note 4)	1178	
EAS	Single Pulse Avalanche Energy (Note 3)	726	mJ
$P_D$	Power Dissipation for Single Operation $T_C = 25^\circ\text{C}$	43	W
	Power Dissipation for Single Operation $T_A = 25^\circ\text{C}$ (Note 1a)	2.3	
$T_J, T_{STG}$	Operating and Storage Junction Temperature Range	$-55$ to $+150$	$^\circ\text{C}$

## THERMAL CHARACTERISTICS

Symbol	Parameter	Ratings	Unit
$R_{\theta JC}$	Thermal Resistance, Junction to Case	2.9	$^\circ\text{C}/\text{W}$
$R_{\theta JA}$	Thermal Resistance, Junction to Ambient (Note 1a)	55	

## PACKAGE MARKING AND ORDERING INFORMATION

Device Marking	Device	Package	Reel Size	Tape Width	Quantity
FDMD8630	FDMD8630	Power 5 x 6	13"	12 mm	3000 Units

## ELECTRICAL CHARACTERISTICS $T_J = 25^\circ\text{C}$ Unless Otherwise Noted

Symbol	Parameter	Test Conditions	Min	Typ	Max	Units
<b>OFF CHARACTERISTICS</b>						
$BV_{DSS}$	Drain to Source Breakdown Voltage	$I_D = 250 \mu\text{A}, V_{GS} = 0 \text{ V}$	30			V
$\Delta BV_{DSS} / \Delta T_J$	Breakdown Voltage Temperature Coefficient	$I_D = 250 \mu\text{A}$ , referenced to $25^\circ\text{C}$		15		$\text{mV}/^\circ\text{C}$
$I_{DSS}$	Zero Gate Voltage Drain Current	$V_{DS} = 24 \text{ V}, V_{GS} = 0 \text{ V}$			1	$\mu\text{A}$
$I_{GSS}$	Gate to Source Leakage Current, Forward	$V_{GS} = 20 \text{ V}, V_{DS} = 0 \text{ V}$			100	nA
<b>ON CHARACTERISTICS</b>						
$V_{GS(th)}$	Gate to Source Threshold Voltage	$V_{GS} = V_{DS}, I_D = 250 \mu\text{A}$	1.0	1.6	3.0	V
$\Delta V_{GS(th)} / \Delta T_J$	Gate to Source Threshold Voltage Temperature Coefficient	$I_D = 250 \mu\text{A}$ , referenced to $25^\circ\text{C}$		-6		$\text{mV}/^\circ\text{C}$
$r_{DS(on)}$	Static Drain to Source On Resistance	$V_{GS} = 10 \text{ V}, I_D = 38 \text{ A}$		0.6	1.0	m $\Omega$
		$V_{GS} = 4.5 \text{ V}, I_D = 33 \text{ A}$		0.8	1.3	
		$V_{GS} = 4.5 \text{ V}, I_D = 33 \text{ A}, T_J = 125^\circ\text{C}$		0.9	1.5	
$g_{FS}$	Forward Transconductance	$V_{DD} = 5 \text{ V}, I_D = 38 \text{ A}$		281		S
<b>DYNAMIC CHARACTERISTICS</b>						
$C_{iss}$	Input Capacitance	$V_{DS} = 15 \text{ V}, V_{GS} = 0 \text{ V}, f = 1 \text{ MHz}$		7090	9930	pF
$C_{oss}$	Output Capacitance			2025	2835	pF
$C_{riss}$	Reverse Transfer Capacitance			212	300	pF
$R_g$	Gate Resistance			0.1	1.9	3.8
<b>SWITCHING CHARACTERISTICS</b>						

# FDMD8630

## ELECTRICAL CHARACTERISTICS $T_J = 25^\circ\text{C}$ Unless Otherwise Noted (continued)

Symbol	Parameter	Test Conditions	Min	Typ	Max	Units
<b>SWITCHING CHARACTERISTICS</b>						
$t_{d(on)}$	Turn-On Delay Time	$V_{DD} = 15\text{ V}$ , $I_D = 38\text{ A}$ $V_{GS} = 10\text{ V}$ , $R_{GEN} = 6\ \Omega$		14	26	ns
$t_r$	Rise Time			15	27	ns
$t_{d(off)}$	Turn-Off Delay Time			66	105	ns
$t_f$	Fall Time			24	39	ns
$Q_{g(TOT)}$	Total Gate Charge	$V_{GS} = 0\text{ V to }10\text{ V}$	$V_{DD} = 15\text{ V}$ $I_D = 38\text{ A}$	97	142	nC
$Q_{g(TOT)}$	Total Gate Charge	$V_{GS} = 0\text{ V to }4.5\text{ V}$		46	74	nC
$Q_{gs}$	Gate to Source Gate Charge			17		nC
$Q_{gd}$	Gate to Drain "Miller" Charge			12		nC
<b>DRAIN-SOURCE DIODE CHARACTERISTICS</b>						
$V_{SD}$	Source to Drain Diode Forward Voltage	$V_{GS} = 0\text{ V}$ , $I_S = 38\text{ A}$ (Note 2)		0.8	1.3	V
$V_{SD}$	Source to Drain Diode Forward Voltage	$V_{GS} = 0\text{ V}$ , $I_S = 2\text{ A}$ (Note 2)		0.7	1.2	V
$t_{rr}$	Reverse Recovery Time	$I_F = 38\text{ A}$ , $di/dt = 100\text{ A}/\mu\text{s}$		64	103	ns
$Q_{rr}$	Reverse Recovery Charge			56	90	nC

1.  $R_{\theta JA}$  is determined with the device mounted on a 1 in<sup>2</sup> pad 2 oz copper pad on a 1.5 x 1.5 in. board of FR-4 material.  $R_{\theta JA}$  is guaranteed by design while  $R_{\theta CA}$  is determined by the user's board design.

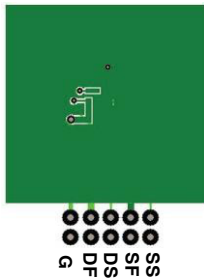

a.  $55^\circ\text{C}/\text{W}$  when mounted on a 1 in<sup>2</sup> pad of 2 oz copper

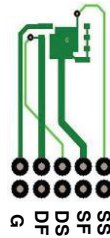

b.  $125^\circ\text{C}/\text{W}$  when mounted on a minimum pad of 2 oz copper

- Pulse Test: Pulse Width < 300  $\mu\text{s}$ , Duty cycle < 2.0%.
- $E_{AS}$  of 726 mJ is based on starting  $T_J = 25^\circ\text{C}$ ,  $L = 3\text{ mH}$ ,  $I_{AS} = 22\text{ A}$ ,  $V_{DD} = 30\text{ V}$ ,  $V_{GS} = 10\text{ V}$ . 100% tested at  $L = 0.1\text{ mH}$ ,  $I_{AS} = 70\text{ A}$ .
- Pulsed  $I_d$  please refer to Fig 11 SOA graph for more details.
- Computed continuous current limited to Max Junction Temperature only, actual continuous current will be limited by thermal & electro-mechanical application board design.

TYPICAL CHARACTERISTICS

$T_J = 25^\circ\text{C}$  Unless Otherwise Noted

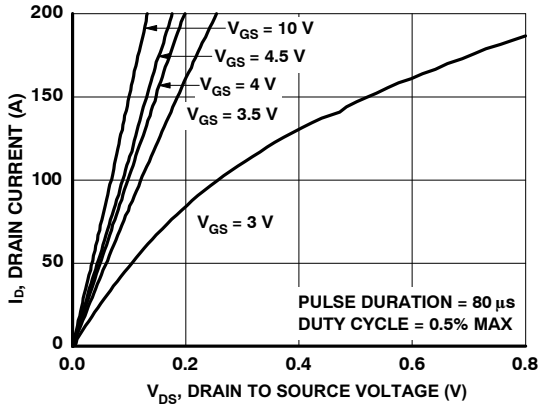

Figure 1. On-Region Characteristics

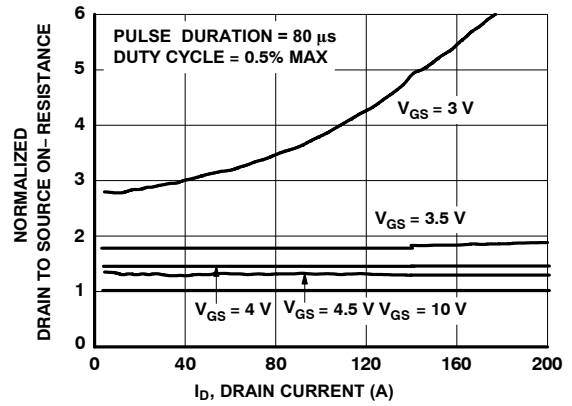

Figure 2. Normalized On-Resistance vs Drain Current and Gate Voltage

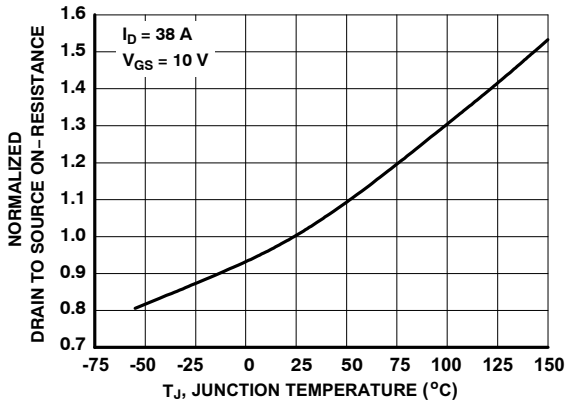

Figure 3. Normalized On Resistance vs Junction Temperature

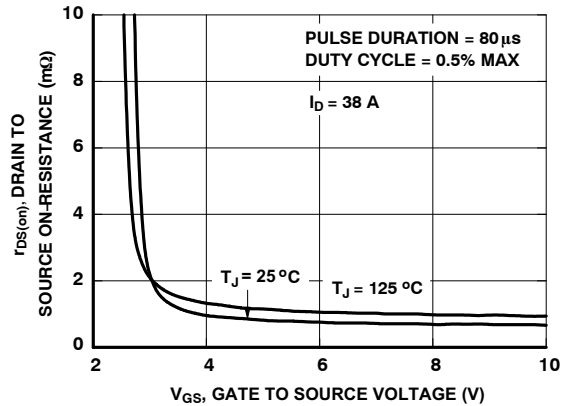

Figure 4. On-Resistance vs Gate to Source Voltage

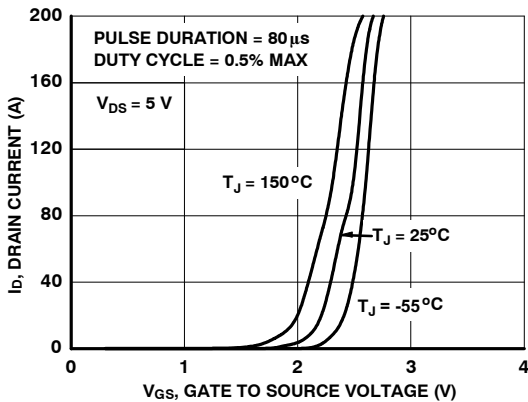

Figure 5. Transfer Characteristics

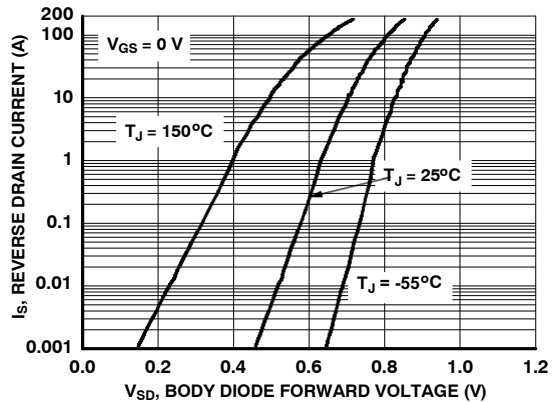

Figure 6. Source to Drain Diode Forward Voltage vs Source Current

TYPICAL CHARACTERISTICS

T<sub>J</sub> = 25°C Unless Otherwise Noted (continued)

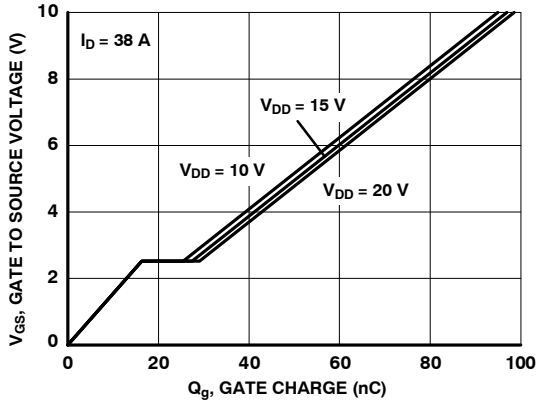

Figure 7. Gate Charge Characteristics

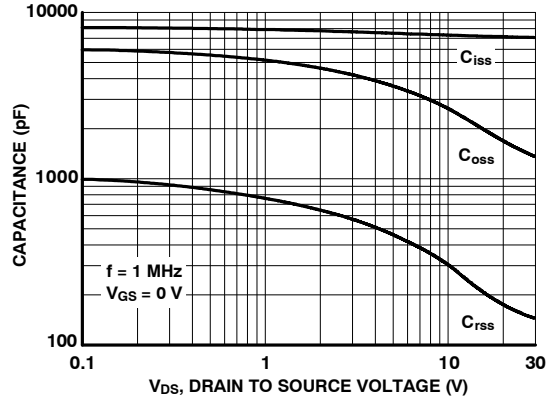

Figure 8. Capacitance vs Drain to Source Voltage

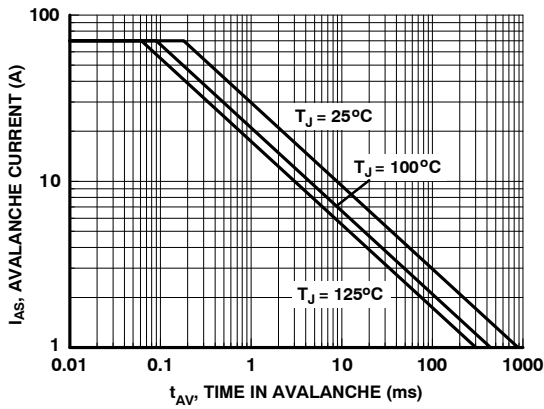

Figure 9. Unclamped Inductive Switching Capability

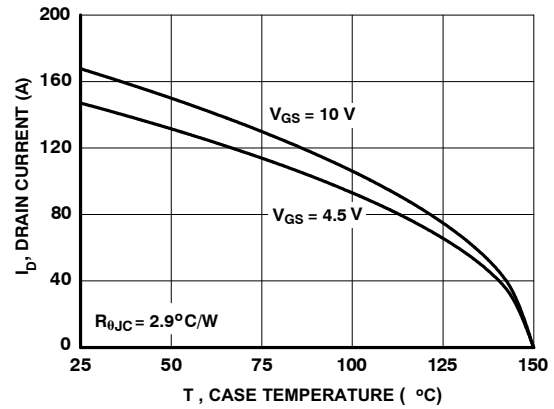

Figure 10. Maximum Continuous Drain Current vs Case Temperature

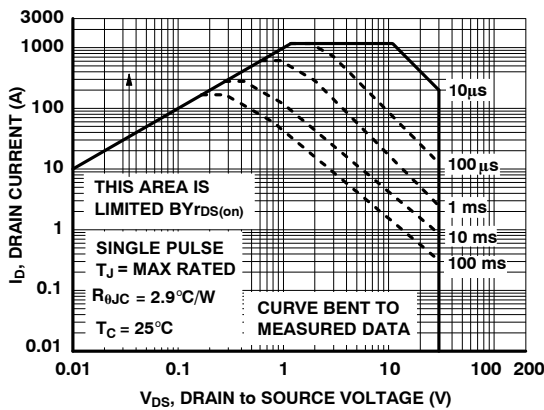

Figure 11. Forward Bias Safe Operating Area

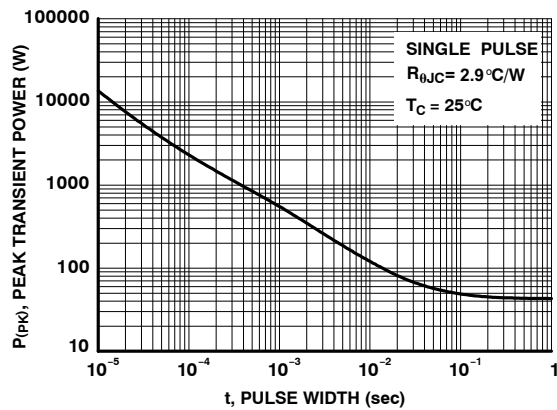

Figure 12. Single Pulse Maximum Power Dissipation

TYPICAL CHARACTERISTICS

T<sub>J</sub> = 25°C Unless Otherwise Noted (continued)

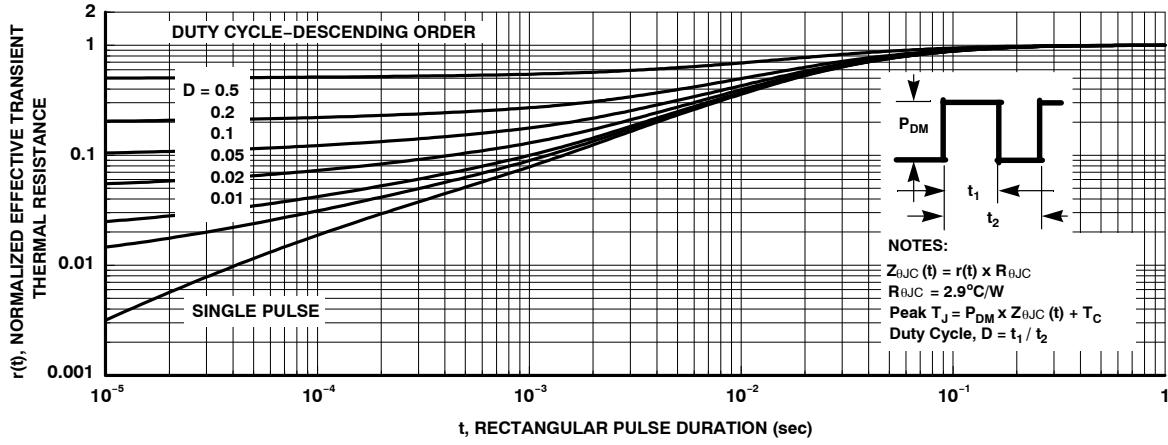
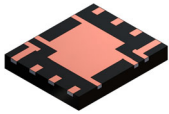

Figure 13. Junction-to-Ambient Transient Thermal Response Curve

# MECHANICAL CASE OUTLINE

## PACKAGE DIMENSIONS



### PQFN8 5X6, 1.27P CASE 483AS ISSUE A

DATE 17 MAY 2021

NOTES:

- A) PACKAGE REFERENCE : TO JEDEC REGISTRATION, MO-240B, VARIATION AA.
- B) ALL DIMENSIONS ARE IN MILLIMETERS.
- C) DIMENSIONS DO NOT INCLUDE BURRS OR MOLD FLASH. MOLD FLASH OR BURRS DOES NOT EXCEED 0.10MM.
- D) DIMENSIONING AND TOLERANCING PER ASME Y14.5M-2009
- E) IT IS RECOMMENDED TO HAVE NO TRACES OR VIAS WITHIN THE KEEP-OUT AREA

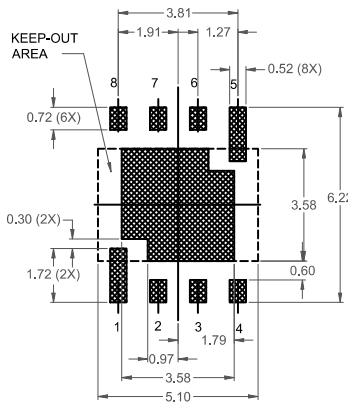
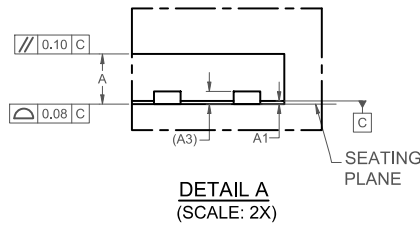
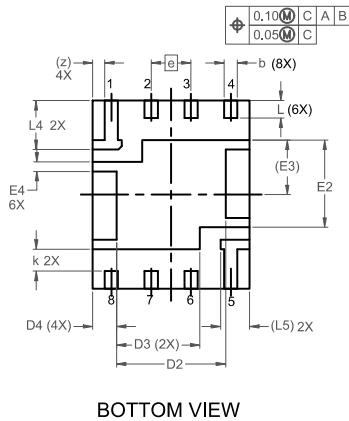
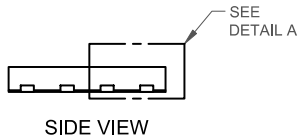
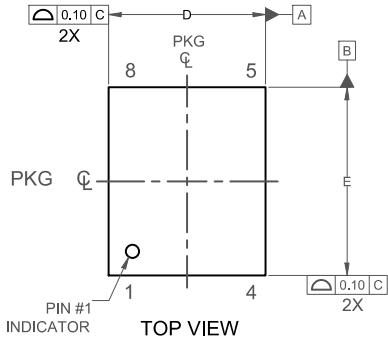

\*FOR ADDITIONAL INFORMATION ON OUR PB-FREE STRATEGY AND SOLDERING DETAILS, PLEASE DOWNLOAD THE ON SEMICONDUCTOR SOLDERING AND MOUNTING TECHNIQUES REFERENCE MANUAL, SOLDERRM/D.

DIM	MILLIMETERS		
	MIN.	NOM.	MAX.
A	0.70	0.75	0.80
A1	0.00	-	0.05
b	0.37	0.42	0.47
A3	0.20 REF		
D	4.90	5.00	5.10
D2	3.38	3.48	3.58
D3	2.55	2.65	2.75
D4	0.66	0.76	0.86
E	5.90	6.00	6.10
E2	2.68	2.78	2.88
E3	1.74 REF		
E4	0.25	0.30	0.35
e	1.27 BSC		
k	0.60	0.70	0.80
L	0.46	0.56	0.66
L4	1.46	1.56	1.66
L5	0.82	0.92	1.02
z	0.39 REF		

<b>DOCUMENT NUMBER:</b>	<b>98AON13667G</b>	Electronic versions are uncontrolled except when accessed directly from the Document Repository. Printed versions are uncontrolled except when stamped "CONTROLLED COPY" in red.
<b>DESCRIPTION:</b>	<b>PQFN8 5X6, 1.27P</b>	<b>PAGE 1 OF 1</b>

ON Semiconductor and are trademarks of Semiconductor Components Industries, LLC dba ON Semiconductor or its subsidiaries in the United States and/or other countries. ON Semiconductor reserves the right to make changes without further notice to any products herein. ON Semiconductor makes no warranty, representation or guarantee regarding the suitability of its products for any particular purpose, nor does ON Semiconductor assume any liability arising out of the application or use of any product or circuit, and specifically disclaims any and all liability, including without limitation special, consequential or incidental damages. ON Semiconductor does not convey any license under its patent rights nor the rights of others.

**onsemi**, **Onsemi**, and other names, marks, and brands are registered and/or common law trademarks of Semiconductor Components Industries, LLC dba "**onsemi**" or its affiliates and/or subsidiaries in the United States and/or other countries. **onsemi** owns the rights to a number of patents, trademarks, copyrights, trade secrets, and other intellectual property. A listing of **onsemi**'s product/patent coverage may be accessed at [www.onsemi.com/site/pdf/Patent-Marking.pdf](http://www.onsemi.com/site/pdf/Patent-Marking.pdf). **onsemi** reserves the right to make changes at any time to any products or information herein, without notice. The information herein is provided "as-is" and **onsemi** makes no warranty, representation or guarantee regarding the accuracy of the information, product features, availability, functionality, or suitability of its products for any particular purpose, nor does **onsemi** assume any liability arising out of the application or use of any product or circuit, and specifically disclaims any and all liability, including without limitation special, consequential or incidental damages. Buyer is responsible for its products and applications using **onsemi** products, including compliance with all laws, regulations and safety requirements or standards, regardless of any support or applications information provided by **onsemi**. "Typical" parameters which may be provided in **onsemi** data sheets and/or specifications can and do vary in different applications and actual performance may vary over time. All operating parameters, including "Typicals" must be validated for each customer application by customer's technical experts. **onsemi** does not convey any license under any of its intellectual property rights nor the rights of others. **onsemi** products are not designed, intended, or authorized for use as a critical component in life support systems or any FDA Class 3 medical devices or medical devices with a same or similar classification in a foreign jurisdiction or any devices intended for implantation in the human body. Should Buyer purchase or use **onsemi** products for any such unintended or unauthorized application, Buyer shall indemnify and hold **onsemi** and its officers, employees, subsidiaries, affiliates, and distributors harmless against all claims, costs, damages, and expenses, and reasonable attorney fees arising out of, directly or indirectly, any claim of personal injury or death associated with such unintended or unauthorized use, even if such claim alleges that **onsemi** was negligent regarding the design or manufacture of the part. **onsemi** is an Equal Opportunity/Affirmative Action Employer. This literature is subject to all applicable copyright laws and is not for resale in any manner.

## ADDITIONAL INFORMATION

### TECHNICAL PUBLICATIONS:

Technical Library: [www.onsemi.com/design/resources/technical-documentation](http://www.onsemi.com/design/resources/technical-documentation)  
onsemi Website: [www.onsemi.com](http://www.onsemi.com)

### ONLINE SUPPORT: [www.onsemi.com/support](http://www.onsemi.com/support)

For additional information, please contact your local Sales Representative at [www.onsemi.com/support/sales](http://www.onsemi.com/support/sales)