

MOSFET – N-Channel, UltraFET Trench

150 V, 27 A, 47 mΩ

FDMS2572

General Description

UltraFET™ devices combine characteristics that enable benchmark efficiency in power conversion applications. Optimized for $r_{DS(on)}$, low ESR, low total and Miller gate charge, these devices are ideal for high frequency DC to DC converters.

Features

- Max $r_{DS(on)}$ = 47 mΩ at $V_{GS} = 10\text{ V}$, $I_D = 4.5\text{ A}$
- Max $r_{DS(on)}$ = 53 mΩ at $V_{GS} = 6\text{ V}$, $I_D = 4.5\text{ A}$
- Low Miller Charge
- Optimized Efficiency at High Frequencies
- UIS Capability (Single Pulse and Repetitive Pulse)
- This Device is Pb-Free and is RoHS Compliant

Applications

- Distributed Power Architectures and VRMs
- Primary Switch for 24 V and 48 V Systems
- High Voltage Synchronous Rectifier

MOSFET MAXIMUM RATINGS ($T_A = 25^\circ\text{C}$ unless otherwise noted)

| Symbol | Parameter | Ratings | Unit |
|----------------|--|-----------------------|------------------|
| V_{DS} | Drain to Source Voltage | 150 | V |
| V_{GS} | Gate to Source Voltage | ±20 | V |
| I_D | Drain Current: – Continuous (Package limited) $T_C = 25^\circ\text{C}$ – Continuous (Silicon limited) $T_C = 25^\circ\text{C}$ – Continuous, $T_A = 25^\circ\text{C}$ (Note 1a) – Pulsed | 27 27 4.5 30 | A |
| E_{AS} | Single Pulse Avalanche Energy (Note 3) | 150 | mJ |
| P_D | Power Dissipation: $T_C = 25^\circ\text{C}$ $T_A = 25^\circ\text{C}$ (Note 1a) | 78 2.5 | W |
| T_J, T_{STG} | Operating and Storage Junction Temperature Range | –55 to +150 | $^\circ\text{C}$ |

Stresses exceeding those listed in the Maximum Ratings table may damage the device. If any of these limits are exceeded, device functionality should not be assumed, damage may occur and reliability may be affected.

THERMAL CHARACTERISTICS

| Symbol | Parameter | Ratings | Unit |
|-----------------|---|---------|---------------------------|
| $R_{\theta JC}$ | Thermal Resistance, Junction to Case | 1.6 | $^\circ\text{C}/\text{W}$ |
| $R_{\theta JA}$ | Thermal Resistance, Junction to Ambient (Note 1a) | 50 | |

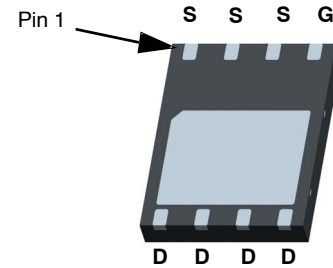

Power 56 (Bottom View)

WDFN8 5x6, 1.27P
CASE 506DP

ELECTRICAL CONNECTION

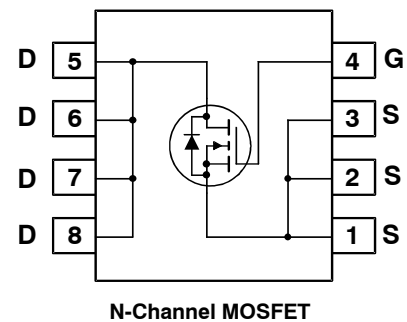

N-Channel MOSFET

MARKING DIAGRAM

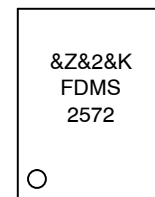

&Z = Assembly Plant Code
&2 = Numeric Date Code
&K = Lot Code
FDMS2572 = Specific Device Code

ORDERING INFORMATION

See detailed ordering and shipping information on page 3 of this data sheet.

FDMS2572

ELECTRICAL CHARACTERISTICS (T_J = 25°C unless otherwise noted)

| Symbol | Parameter | Test Condition | Min | Typ | Max | Unit |
|-------------------------------------|---|--|-----|-----|------|-------|
| OFF CHARACTERISTICS | | | | | | |
| BV _{DSS} | Drain to Source Breakdown Voltage | I _D = 250 μA, V _{GS} = 0 V | 150 | | | V |
| ΔBV _{DSS} /ΔT _J | Breakdown Voltage Temperature Coefficient | I _D = 250 μA, referenced to 25°C | | 180 | | mV/°C |
| I _{DSS} | Zero Gate Voltage Drain Current | V _{DS} = 120 V, V _{GS} = 0 V | | | 1 | μA |
| I _{GSS} | Gate to Source Leakage Current | V _{GS} = ±20 V, V _{DS} = 0 V | | | ±100 | nA |

ON CHARACTERISTICS (Note 2)

| | | | | | | |
|---------------------------------------|--|---|---|------|-----|-------|
| V _{GS(th)} | Gate to Source Threshold Voltage | V _{GS} = V _{DS} , I _D = 250 μA | 2 | 3 | 4 | V |
| ΔV _{GS(th)} /ΔT _J | Gate to Source Threshold Voltage Temperature Coefficient | I _D = 250 μA, referenced to 25 °C | | -9.8 | | mV/°C |
| r _{DS(on)} | Static Drain to Source On Resistance | V _{GS} = 10 V, I _D = 4.5 A | | 36 | 47 | mΩ |
| | | V _{GS} = 6 V, I _D = 4.5 A | | 39 | 53 | |
| | | V _{GS} = 10 V, I _D = 4.5 A, T _J = 125 °C | | 69 | 103 | |
| g _{FS} | Forward Transconductance | V _{DS} = 10 V, I _D = 4.5 A | | 14 | | S |

DYNAMIC CHARACTERISTICS

| | | | | | | |
|------------------|------------------------------|---|-----|------|------|----|
| C _{iss} | Input Capacitance | V _{DS} = 75 V, V _{GS} = 0 V, f = 1 MHz | | 1960 | 2610 | pF |
| C _{oss} | Output Capacitance | | | 130 | 175 | pF |
| C _{rss} | Reverse Transfer Capacitance | | | 30 | 45 | pF |
| R _g | Gate Resistance | f = 1 MHz | 0.1 | 1.3 | 2.6 | Ω |

SWITCHING CHARACTERISTICS

| | | | | | | |
|---------------------|-------------------------------|---|--|----|----|----|
| t _{d(on)} | Turn-On Delay Time | V _{DD} = 75 V, I _D = 1.0 A, V _{GS} = 10 V, R _{GEN} = 6 Ω | | 11 | 20 | ns |
| t _r | Rise Time | | | 8 | 16 | ns |
| t _{d(off)} | Turn-Off Delay Time | | | 38 | 61 | ns |
| t _f | Fall Time | | | 31 | 50 | ns |
| Q _{g(TOT)} | Total Gate Charge at 10 V | V _{GS} = 0 V to 10 V, V _{DD} = 75 V, I _D = 4.5 A | | 31 | 43 | nC |
| Q _{gs} | Gate to Source Gate Charge | V _{DD} = 75 V, I _D = 4.5 A | | 9 | | nC |
| Q _{gd} | Gate to Drain "Miller" Charge | | | 7 | | nC |

DRAIN-SOURCE DIODE CHARACTERISTICS

| | | | | | | |
|-----------------|---------------------------------------|--|--|-----|-----|----|
| V _{SD} | Source to Drain Diode Forward Voltage | V _{GS} = 0 V, I _S = 2.2 A (Note 2) | | 0.7 | 1.0 | V |
| t _{rr} | Reverse Recovery Time | I _F = 4.5 A, di/dt = 100 A/μs | | 67 | 101 | ns |
| Q _{rr} | Reverse Recovery Charge | | | 130 | 195 | nC |

Product parametric performance is indicated in the Electrical Characteristics for the listed test conditions, unless otherwise noted. Product performance may not be indicated by the Electrical Characteristics if operated under different conditions.

NOTES:

- R_{θJA} is determined with the device mounted on a 1 in² pad 2 oz copper pad on a 1.5 × 1.5 in. board of FR-4 material. R_{θJC} is guaranteed by design while R_{θCA} is determined by the user's board design.

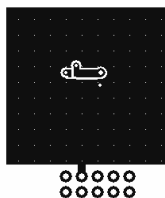

- 50°C/W when mounted on a 1 in² pad of 2 oz copper.

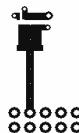

- 125°C/W when mounted on a minimum pad of 2 oz copper.

- Pulse Test: Pulse Width < 300 μs, Duty cycle < 2.0%.
- E_{AS} of 150 mJ is based on starting T_J = 25°C, L = 3 mH, I_{AS} = 10 A, V_{DD} = 150 V, V_{GS} = 10 V.

FDMS2572

ORDERING INFORMATION AND PACKAGE MARKING

| Device | Device Marking | Package | Shipping† |
|----------|----------------|----------------------------|--------------------------|
| FDMS2572 | FDMS2572 | WDFN8 5x6, 1.27P (Pb-Free) | 3000 Units / Tape & Reel |

†For information on tape and reel specifications, including part orientation and tape sizes, please refer to our Tape and Reel Packaging Specifications Brochure, BRD8011/D.

TYPICAL CHARACTERISTICS

($T_J = 25^\circ\text{C}$ unless otherwise noted)

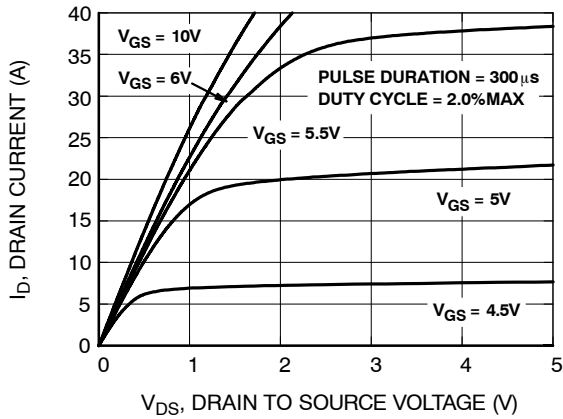

Figure 1. On-Region Characteristics

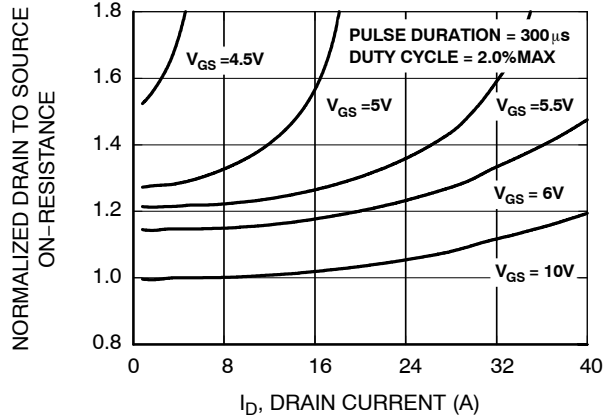

Figure 2. Normalized On-Resistance vs. Drain Current and Gate Voltage

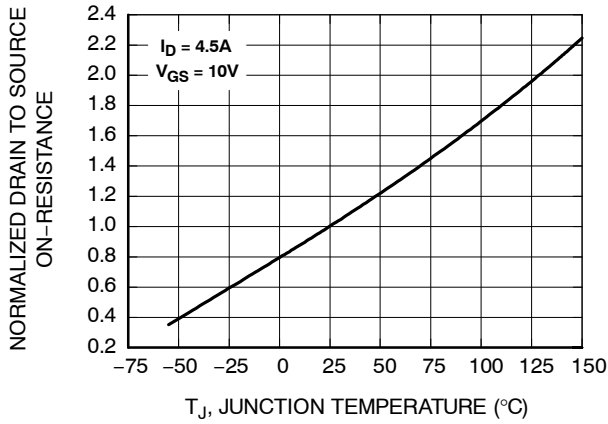

Figure 3. Normalized On-Resistance vs. Junction Temperature

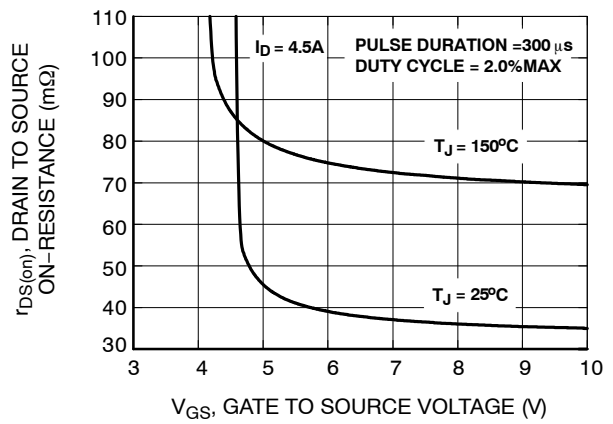

Figure 4. On-Resistance vs. Gate to Source Voltage

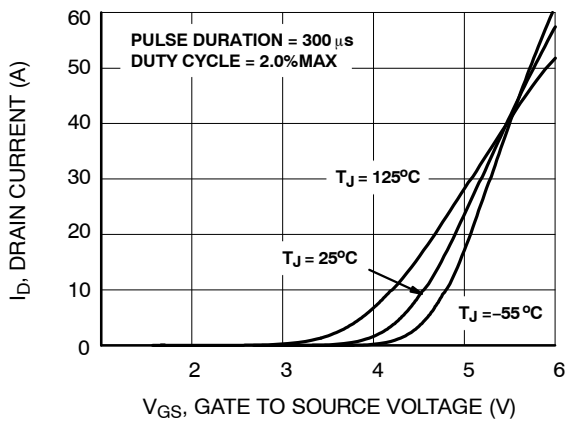

Figure 5. Transfer Characteristics

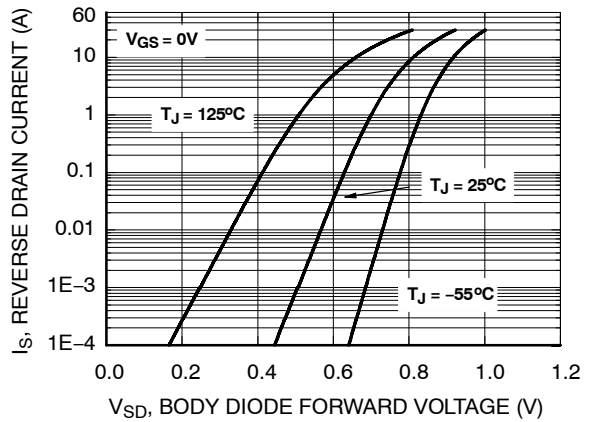

Figure 6. Source to Drain Diode Forward Voltage vs. Source Current

TYPICAL CHARACTERISTICS (continued)

($T_J = 25^\circ\text{C}$ unless otherwise noted)

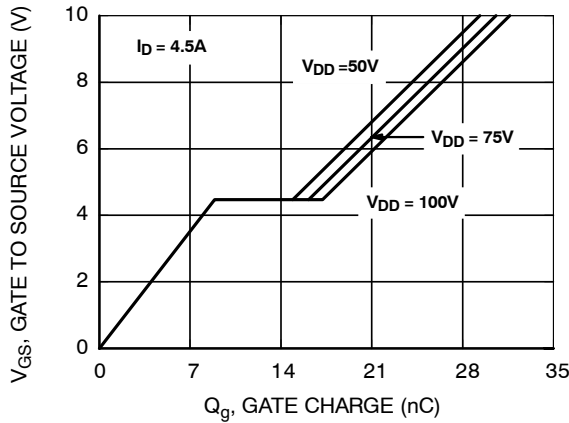

Figure 7. Gate Charge Characteristics

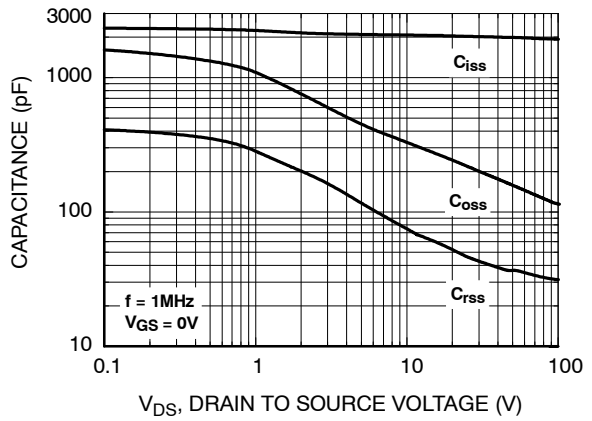

Figure 8. Capacitance vs. Drain to Source Voltage

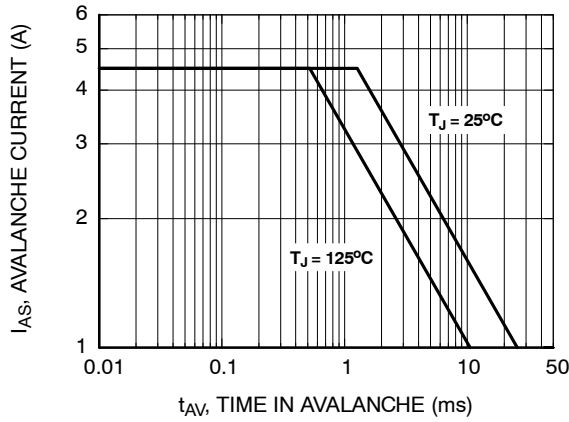

Figure 9. Unclamped Inductive Switching Capability

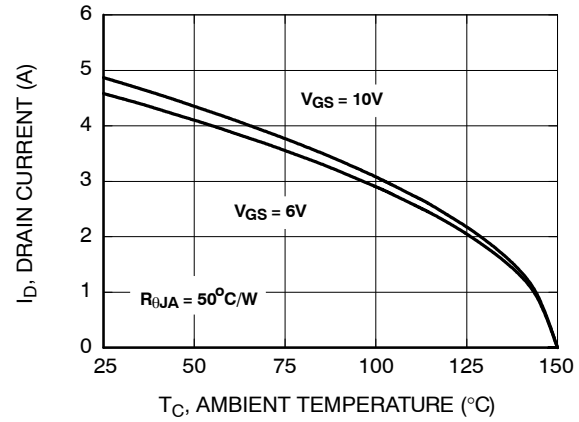

Figure 10. Maximum Continuous Drain Current vs. Ambient Temperature

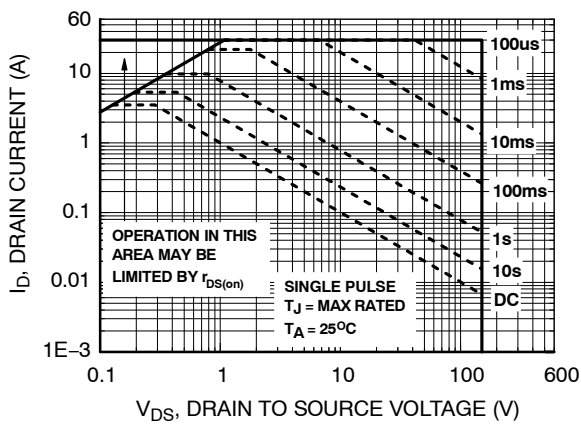

Figure 11. Forward Bias Safe Operating Area

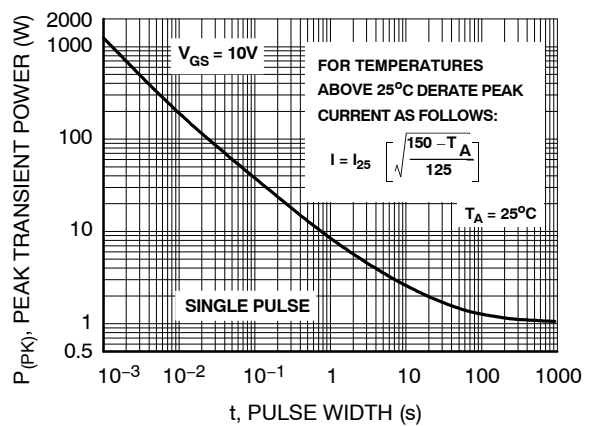

Figure 12. Single Pulse Maximum Power Dissipation

FDMS2572

TYPICAL CHARACTERISTICS (continued)

($T_J = 25^\circ\text{C}$ unless otherwise noted)

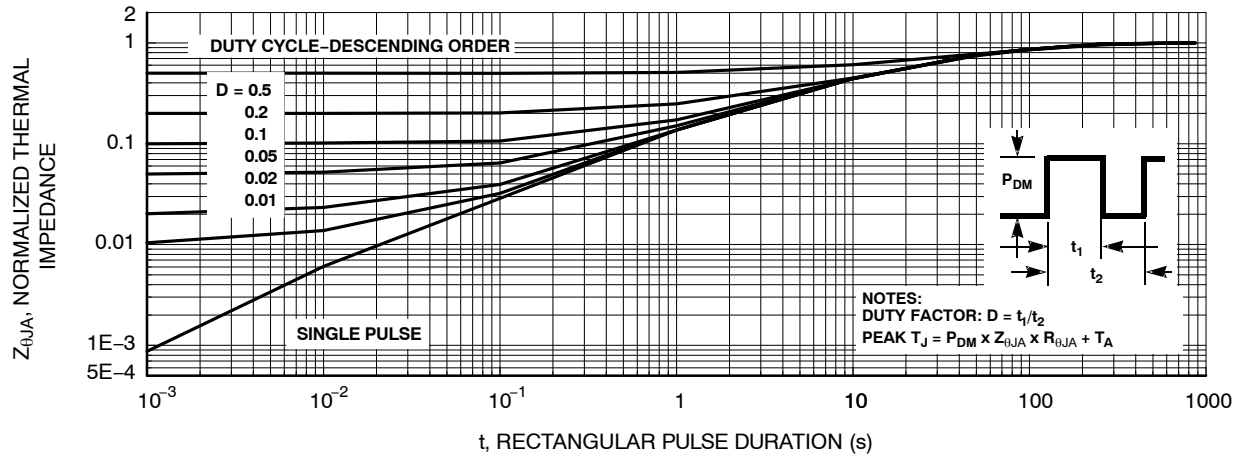

Figure 13. Transient Thermal Response Curve

UltraFET is a trademark of Semiconductor Components Industries, LLC dba "onsemi" or its affiliates and/or subsidiaries in the United States and/or other countries.

MECHANICAL CASE OUTLINE

PACKAGE DIMENSIONS

ON Semiconductor®



WDFN8 5x6, 1.27P
CASE 506DP
ISSUE O

DATE 31 AUG 2016

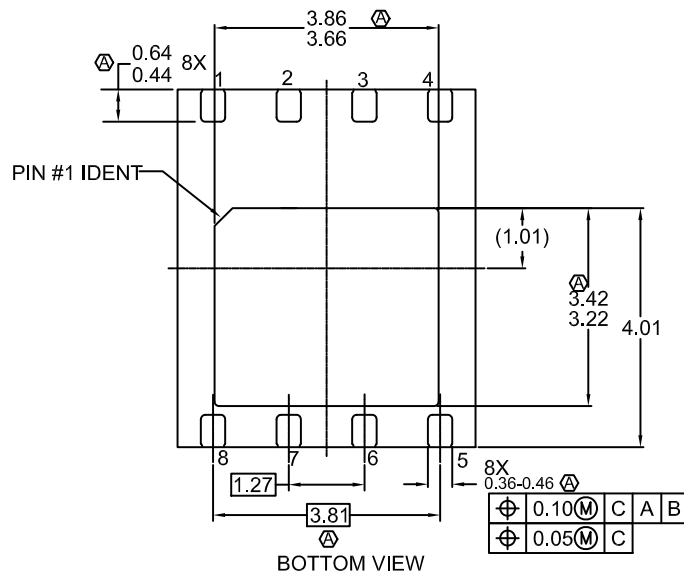
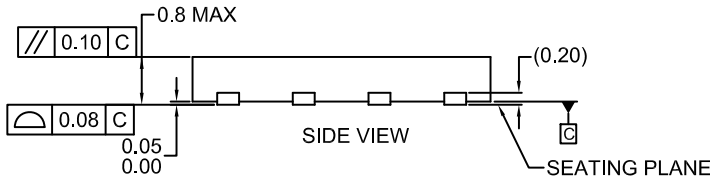
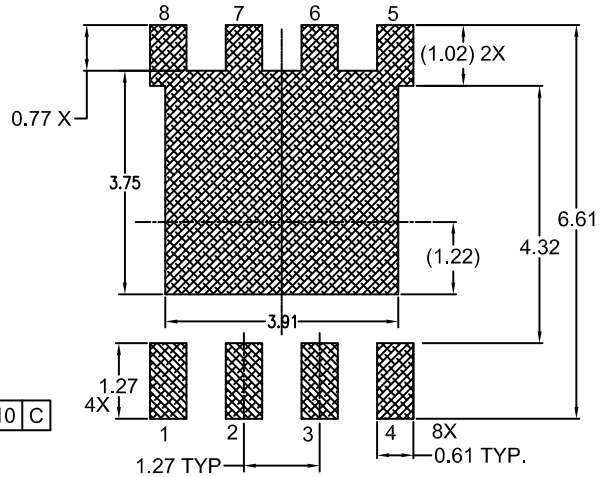
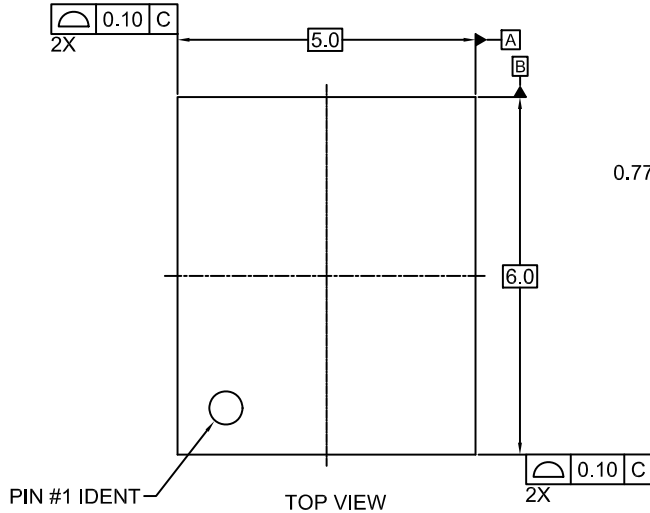

NOTES:

- Ⓐ DOES NOT FULLY CONFORM TO JEDEC REGISTRATION, MO-229.
- B. DIMENSIONS ARE IN MILLIMETERS.
- C. DIMENSIONS AND TOLERANCES PER ASME Y14.5M, 1994
- D. TERMINALS 5,6,7 AND 8 ARE TIED TO THE EXPOSED PADDLE

| | | |
|-------------------------|-------------------------|--|
| DOCUMENT NUMBER: | 98AON13598G | Electronic versions are uncontrolled except when accessed directly from the Document Repository. Printed versions are uncontrolled except when stamped "CONTROLLED COPY" in red. |
| DESCRIPTION: | WDFN8 5X6, 1.27P | PAGE 1 OF 1 |

ON Semiconductor and are trademarks of Semiconductor Components Industries, LLC dba ON Semiconductor or its subsidiaries in the United States and/or other countries. ON Semiconductor reserves the right to make changes without further notice to any products herein. ON Semiconductor makes no warranty, representation or guarantee regarding the suitability of its products for any particular purpose, nor does ON Semiconductor assume any liability arising out of the application or use of any product or circuit, and specifically disclaims any and all liability, including without limitation special, consequential or incidental damages. ON Semiconductor does not convey any license under its patent rights nor the rights of others.

onsemi, **Onsemi**, and other names, marks, and brands are registered and/or common law trademarks of Semiconductor Components Industries, LLC dba "**onsemi**" or its affiliates and/or subsidiaries in the United States and/or other countries. **onsemi** owns the rights to a number of patents, trademarks, copyrights, trade secrets, and other intellectual property. A listing of **onsemi**'s product/patent coverage may be accessed at www.onsemi.com/site/pdf/Patent-Marking.pdf. **onsemi** reserves the right to make changes at any time to any products or information herein, without notice. The information herein is provided "as-is" and **onsemi** makes no warranty, representation or guarantee regarding the accuracy of the information, product features, availability, functionality, or suitability of its products for any particular purpose, nor does **onsemi** assume any liability arising out of the application or use of any product or circuit, and specifically disclaims any and all liability, including without limitation special, consequential or incidental damages. Buyer is responsible for its products and applications using **onsemi** products, including compliance with all laws, regulations and safety requirements or standards, regardless of any support or applications information provided by **onsemi**. "Typical" parameters which may be provided in **onsemi** data sheets and/or specifications can and do vary in different applications and actual performance may vary over time. All operating parameters, including "Typicals" must be validated for each customer application by customer's technical experts. **onsemi** does not convey any license under any of its intellectual property rights nor the rights of others. **onsemi** products are not designed, intended, or authorized for use as a critical component in life support systems or any FDA Class 3 medical devices or medical devices with a same or similar classification in a foreign jurisdiction or any devices intended for implantation in the human body. Should Buyer purchase or use **onsemi** products for any such unintended or unauthorized application, Buyer shall indemnify and hold **onsemi** and its officers, employees, subsidiaries, affiliates, and distributors harmless against all claims, costs, damages, and expenses, and reasonable attorney fees arising out of, directly or indirectly, any claim of personal injury or death associated with such unintended or unauthorized use, even if such claim alleges that **onsemi** was negligent regarding the design or manufacture of the part. **onsemi** is an Equal Opportunity/Affirmative Action Employer. This literature is subject to all applicable copyright laws and is not for resale in any manner.

ADDITIONAL INFORMATION

TECHNICAL PUBLICATIONS:

Technical Library: www.onsemi.com/design/resources/technical-documentation
onsemi Website: www.onsemi.com

ONLINE SUPPORT: www.onsemi.com/support

For additional information, please contact your local Sales Representative at www.onsemi.com/support/sales