

MOSFET – N-Channel, POWERTRENCH[®], DUAL COOL[®] 88

80 V, 164 A, 1.35 mΩ

FDMT1D3N08B

General Description

This N-Channel MOSFET is produced using onsemi's advanced POWERTRENCH process. Advancements in both silicon and DUAL COOL package technologies have been combined to offer the lowest $R_{DS(on)}$ while maintaining excellent switching performance by extremely low Junction-to-Ambient thermal resistance.

Features

- Max $R_{DS(on)}$ = 1.35 mΩ at $V_{GS} = 10\text{ V}$, $I_D = 36\text{ A}$
- Max $R_{DS(on)}$ = 1.8 mΩ at $V_{GS} = 8\text{ V}$, $I_D = 31\text{ A}$
- Advanced Package and Silicon Combination for Low $R_{DS(on)}$ and High Efficiency
- Next Generation Enhanced Body Diode Technology, Engineered for Soft Recovery
- Low Profile 8x8 mm MLP Package
- MSL1 Robust Package Design
- 100% UIL Tested
- RoHS Compliant

Applications

- OringFET / Load Switching
- Synchronous Rectification
- DC-DC Conversion

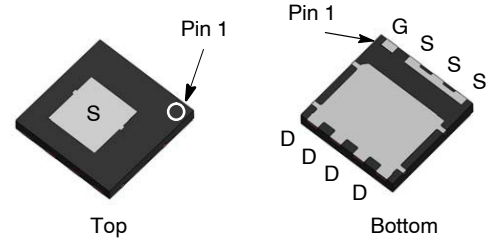

PQFN8 8X8, 2P
(DUAL COOL 88)
CASE 483AQ

MARKING DIAGRAM

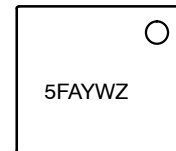

5F	= Specific Device Code
A	= Assembly Plant Code
YW	= Date Code (Year & Week)
Z	= Lot Code

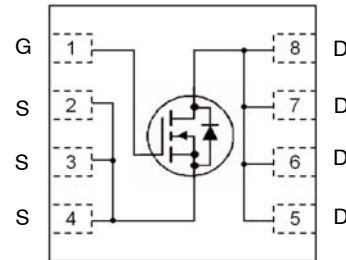

ORDERING INFORMATION

See detailed ordering, marking and shipping information on page 7 of this data sheet.

FDMT1D3N08B

MOSFET MAXIMUM RATINGS ($T_A = 25^\circ\text{C}$ unless otherwise noted)

Symbol	Parameter	Rating	Unit
V_{DS}	Drain to Source Voltage	80	V
V_{GS}	Gate to Source Voltage	± 20	V
I_D	Drain Current – Continuous $T_C = 25^\circ\text{C}$ (Note 5)	164	A
	– Continuous $T_C = 100^\circ\text{C}$ (Note 5)	103	
	– Continuous $T_A = 25^\circ\text{C}$ (Note 1a)	36	
	– Pulsed (Note 4)	864	
E_{AS}	Single Pulse Avalanche Energy (Note 3)	1734	mJ
P_D	Power Dissipation $T_C = 25^\circ\text{C}$	178	W
	Power Dissipation $T_A = 25^\circ\text{C}$ (Note 1a)	3.3	
T_J, T_{STG}	Operating and Storage Junction Temperature Range	-55 to +150	$^\circ\text{C}$

Stresses exceeding those listed in the Maximum Ratings table may damage the device. If any of these limits are exceeded, device functionality should not be assumed, damage may occur and reliability may be affected.

THERMAL CHARACTERISTICS

Symbol	Parameter	Ratings	Unit
$R_{\theta JC}$	Thermal Resistance, Junction to Case (Top Source)	1.9	$^\circ\text{C}/\text{W}$
$R_{\theta JC}$	Thermal Resistance, Junction to Case (Bottom Drain)	0.7	
$R_{\theta JA}$	Thermal Resistance, Junction to Ambient (Note 1a)	38	
$R_{\theta JA}$	Thermal Resistance, Junction to Ambient (Note 1b)	81	
$R_{\theta JA}$	Thermal Resistance, Junction to Ambient (Note 1i)	15	
$R_{\theta JA}$	Thermal Resistance, Junction to Ambient (Note 1j)	21	
$R_{\theta JA}$	Thermal Resistance, Junction to Ambient (Note 1k)	9	

ELECTRICAL CHARACTERISTICS ($T_J = 25^\circ\text{C}$ unless otherwise noted)

Symbol	Parameter	Test Conditions	Min.	Typ.	Max.	Unit
--------	-----------	-----------------	------	------	------	------

OFF CHARACTERISTICS

BV_{DSS}	Drain to Source Breakdown Voltage	$I_D = 250 \mu\text{A}, V_{GS} = 0 \text{ V}$	80	–	–	V
$\frac{\Delta BV_{DSS}}{\Delta T_J}$	Breakdown Voltage Temperature Coefficient	$I_D = 250 \mu\text{A}$, referenced to 25°C	–	50	–	$\text{mV}/^\circ\text{C}$
I_{DSS}	Zero Gate Voltage Drain Current	$V_{DS} = 64 \text{ V}, V_{GS} = 0 \text{ V}$	–	–	1	μA
I_{GSS}	Gate to Source Leakage Current	$V_{GS} = \pm 20 \text{ V}, V_{DS} = 0 \text{ V}$	–	–	100	nA

ON CHARACTERISTICS

$V_{GS(th)}$	Gate to Source Threshold Voltage	$V_{GS} = V_{DS}, I_D = 250 \mu\text{A}$	2.0	3.2	4.0	V
$\frac{\Delta V_{GS(th)}}{\Delta T_J}$	Gate to Source Threshold Voltage Temperature Coefficient	$I_D = 250 \mu\text{A}$, referenced to 25°C	–	-11	–	$\text{mV}/^\circ\text{C}$
$R_{DS(on)}$	Static Drain to Source On Resistance	$V_{GS} = 10 \text{ V}, I_D = 36 \text{ A}$	–	1.1	1.35	m Ω
		$V_{GS} = 8 \text{ V}, I_D = 31 \text{ A}$	–	1.3	1.8	
		$V_{GS} = 10 \text{ V}, I_D = 36 \text{ A}, T_J = 125^\circ\text{C}$	–	1.8	2.2	
g_{FS}	Forward Transconductance	$V_{DS} = 5 \text{ V}, I_D = 36 \text{ A}$	–	116	–	S

FDMT1D3N08B

ELECTRICAL CHARACTERISTICS (T_J = 25°C unless otherwise noted) (continued)

Symbol	Parameter	Test Conditions	Min.	Typ.	Max.	Unit
--------	-----------	-----------------	------	------	------	------

DYNAMIC CHARACTERISTICS

C _{iss}	Input Capacitance	V _{DS} = 40 V, V _{GS} = 0 V, f = 1 MHz	–	14000	19600	pF
C _{oss}	Output Capacitance		–	2050	2870	pF
C _{rss}	Reverse Transfer Capacitance		–	50	150	pF
R _g	Gate Resistance		0.1	1.4	2.1	Ω

SWITCHING CHARACTERISTICS

t _{d(on)}	Turn-On Delay Time	V _{DD} = 40 V, I _D = 36 A, V _{GS} = 10 V, R _{GEN} = 6 Ω	–	63	101	ns
t _r	Rise Time		–	56	90	ns
t _{d(off)}	Turn-Off Delay Time		–	68	109	ns
t _f	Fall Time		–	20	32	ns
Q _{g(TOT)}	Total Gate Charge	V _{GS} = 0 V to 10 V, V _{DD} = 40 V, I _D = 36 A	–	186	260	nC
		V _{GS} = 0 V to 8 V, V _{DD} = 40 V, I _D = 36 A	–	152	213	
Q _{gs}	Gate to Source Charge	V _{DD} = 40 V, I _D = 36 A	–	67	–	nC
Q _{gd}	Gate to Drain "Miller" Charge		–	37	–	nC
Q _{oss}	Output Charge	V _{DD} = 40 V, V _{GS} = 0 V	–	185	–	nC

DRAIN-SOURCE DIODE CHARACTERISTICS

V _{SD}	Source to Drain Diode Forward Voltage	V _{GS} = 0 V, I _S = 2.6 A (Note 2)	–	0.7	1.1	V
		V _{GS} = 0 V, I _S = 36 A (Note 2)	–	0.8	1.2	
t _{rr}	Reverse Recovery Time	I _F = 36 A, di/dt = 100 A/μs	–	83	132	ns
Q _{rr}	Reverse Recovery Charge		–	90	143	nC

Product parametric performance is indicated in the Electrical Characteristics for the listed test conditions, unless otherwise noted. Product performance may not be indicated by the Electrical Characteristics if operated under different conditions.

THERMAL CHARACTERISTICS

Symbol	Parameter	Ratings	Unit
R _{θJC}	Thermal Resistance, Junction to Case (Top Source)	1.9	°C/W
R _{θJC}	Thermal Resistance, Junction to Case (Bottom Drain)	0.7	
R _{θJA}	Thermal Resistance, Junction to Ambient (Note 1a)	38	
R _{θJA}	Thermal Resistance, Junction to Ambient (Note 1b)	81	
R _{θJA}	Thermal Resistance, Junction to Ambient (Note 1c)	26	
R _{θJA}	Thermal Resistance, Junction to Ambient (Note 1d)	34	
R _{θJA}	Thermal Resistance, Junction to Ambient (Note 1e)	14	
R _{θJA}	Thermal Resistance, Junction to Ambient (Note 1f)	16	
R _{θJA}	Thermal Resistance, Junction to Ambient (Note 1g)	26	
R _{θJA}	Thermal Resistance, Junction to Ambient (Note 1h)	60	
R _{θJA}	Thermal Resistance, Junction to Ambient (Note 1i)	15	
R _{θJA}	Thermal Resistance, Junction to Ambient (Note 1j)	21	
R _{θJA}	Thermal Resistance, Junction to Ambient (Note 1k)	9	
R _{θJA}	Thermal Resistance, Junction to Ambient (Note 1l)	11	

FDMT1D3N08B

NOTES:

1. $R_{\theta JA}$ is determined with the device mounted on a FR-4 board using a specified pad of 2 oz copper as shown below. $R_{\theta CA}$ is determined by the user's board design.

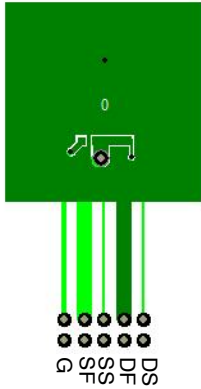

a) 38°C/W when mounted on a 1 in² pad of 2 oz copper.



b) 81°C/W when mounted on a minimum pad of 2 oz copper.

- c) Still air, 20.9 x 10.4 x 12.7 mm Aluminum Heat Sink, 1 in² pad of 2 oz copper
- d) Still air, 20.9 x 10.4 x 12.7 mm Aluminum Heat Sink, minimum pad of 2 oz copper
- e) Still air, 45.2 x 41.4 x 11.7 mm Aavid Thermalloy Part # 10-L41B-11 Heat Sink, 1 in² pad of 2 oz copper
- f) Still air, 45.2 x 41.4 x 11.7 mm Aavid Thermalloy Part # 10-L41B-11 Heat Sink, minimum pad of 2 oz copper
- g) 200FPM Airflow, No Heat Sink, 1 in² pad of 2 oz copper
- h) 200FPM Airflow, No Heat Sink, minimum pad of 2 oz copper
- i) 200FPM Airflow, 20.9 x 10.4 x 12.7 mm Aluminum Heat Sink, 1 in² pad of 2 oz copper
- j) 200FPM Airflow, 20.9 x 10.4 x 12.7 mm Aluminum Heat Sink, minimum pad of 2 oz copper
- k) 200FPM Airflow, 45.2 x 41.4 x 11.7 mm Aavid Thermalloy Part # 10-L41B-11 Heat Sink, 1 in² pad of 2 oz copper
- l) 200FPM Airflow, 45.2 x 41.4 x 11.7 mm Aavid Thermalloy Part # 10-L41B-11 Heat Sink, minimum pad of 2 oz copper

2. Pulse Test: Pulse Width < 300 μ s, Duty cycle < 2.0%.

3. E_{AS} of 1734 mJ is based on starting $T_J = 25^\circ\text{C}$; N-ch: $L = 3$ mH, $I_{AS} = 34$ A, $V_{DD} = 80$ V, $V_{GS} = 10$ V. 100% test at $L = 0.3$ mH, $I_{AS} = 77$ A.

4. Pulsed I_d please refer to Figure 11 SOA graph for more details.

5. Computed continuous current limited to Max Junction Temperature only, actual continuous current will be limited by thermal & electro-mechanical application board design.

FDMT1D3N08B

TYPICAL CHARACTERISTICS ($T_J = 25^\circ\text{C}$ unless otherwise noted)

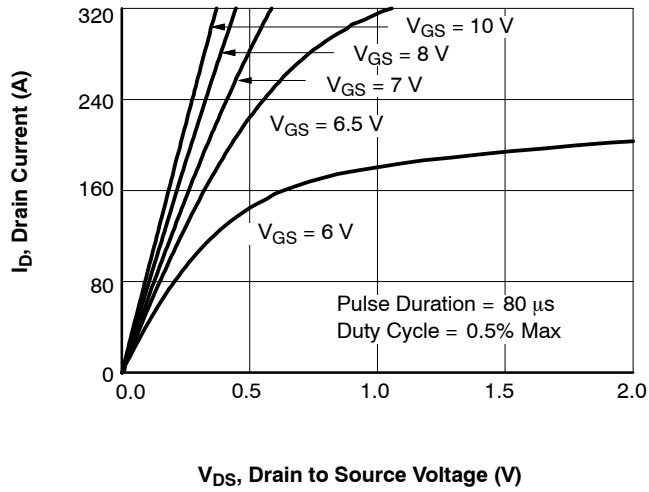

Figure 1. On-Region Characteristics

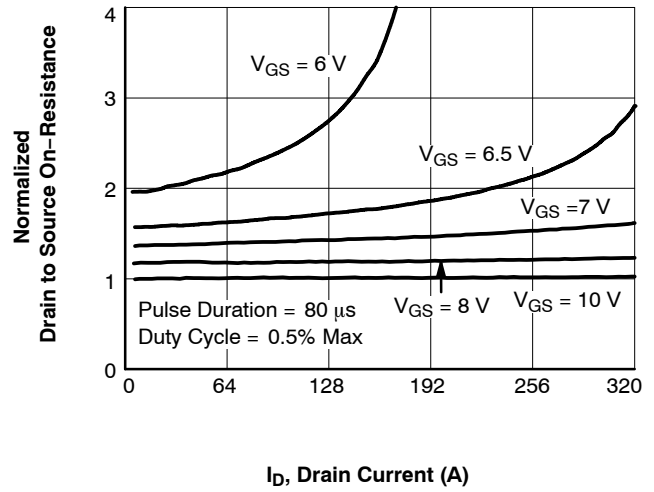

Figure 2. Normalized On-Resistance vs. Drain Current and Gate Voltage

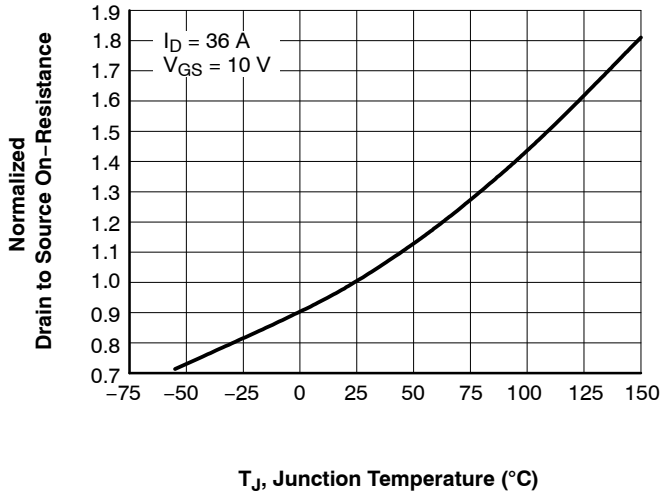

Figure 3. Normalized On-Resistance vs. Junction Temperature

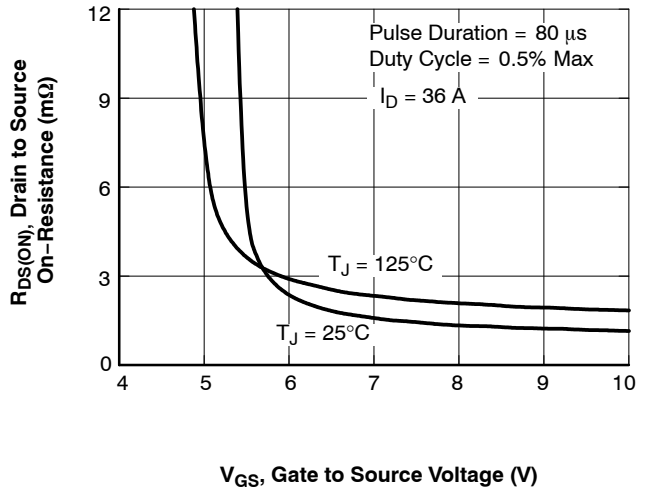

Figure 4. On-Resistance vs Gate-to-Source Voltage

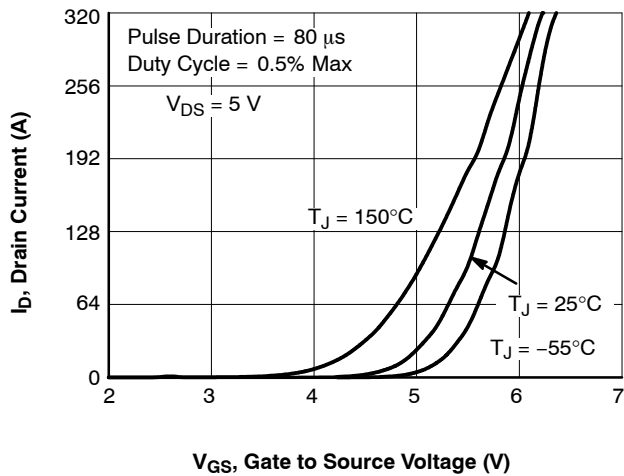

Figure 5. Transfer Characteristics

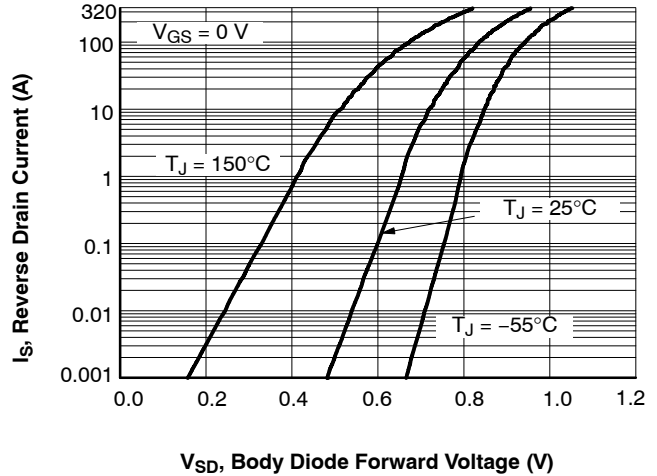

Figure 6. Source to Drain Diode Forward Voltage vs Source Current

FDMT1D3N08B

TYPICAL CHARACTERISTICS ($T_J = 25^\circ\text{C}$ unless otherwise noted)(continued)

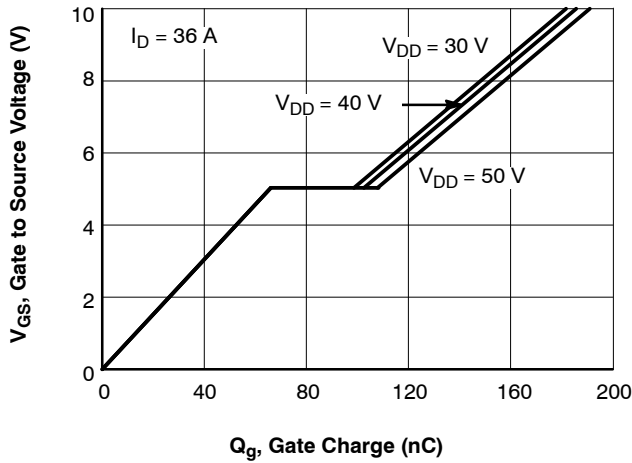

Figure 7. Gate Charge Characteristics

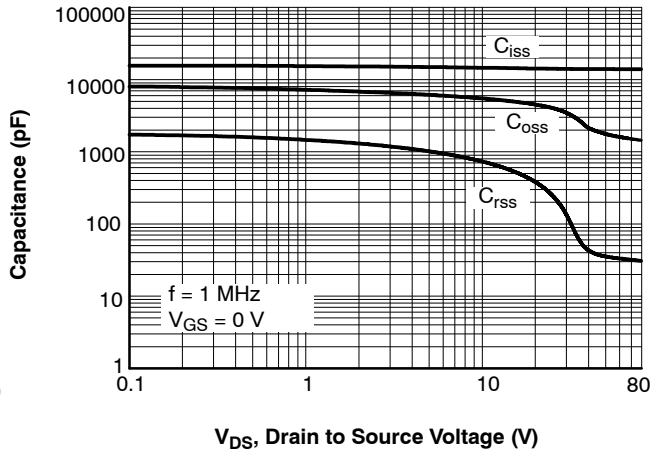

Figure 8. Capacitance vs Drain to Source Voltage

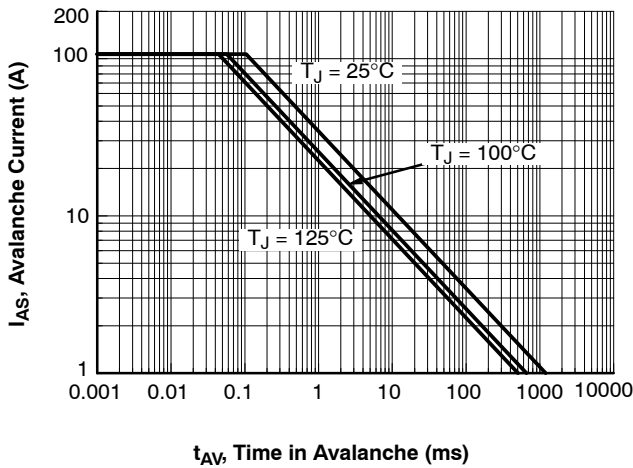

Figure 9. Unclamped Inductive Switching Capability

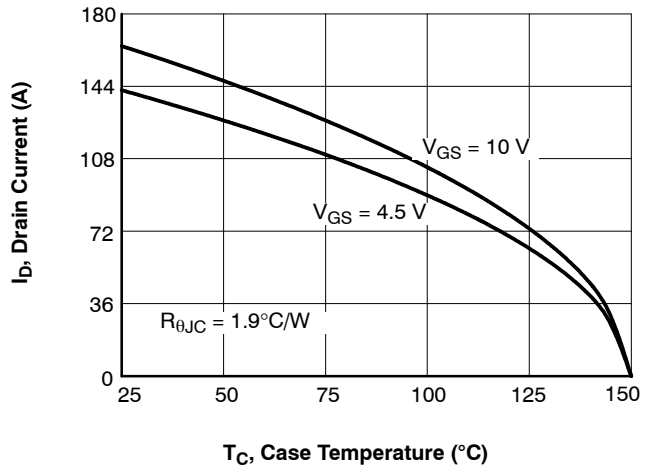

Figure 10. Maximum Continuous Drain Current vs. Case Temperature

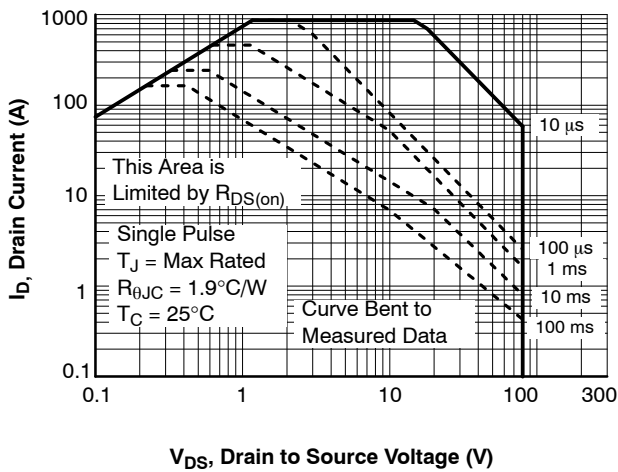

Figure 11. Forward Bias Safe Operating Area

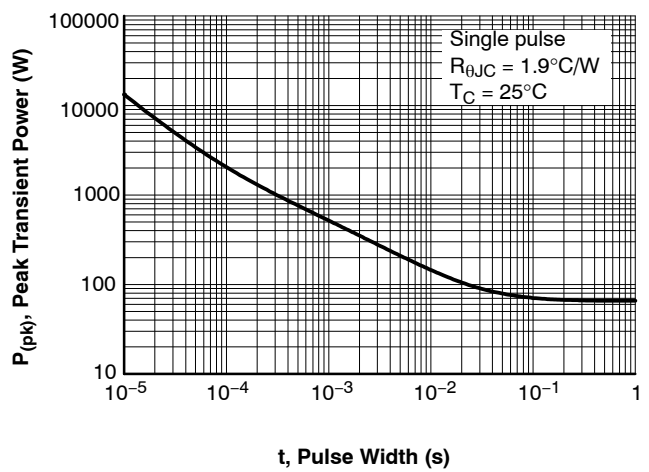

Figure 12. Single Pulse Maximum Power Dissipation

FDMT1D3N08B

TYPICAL CHARACTERISTICS ($T_J = 25^\circ\text{C}$ unless otherwise noted)(continued)

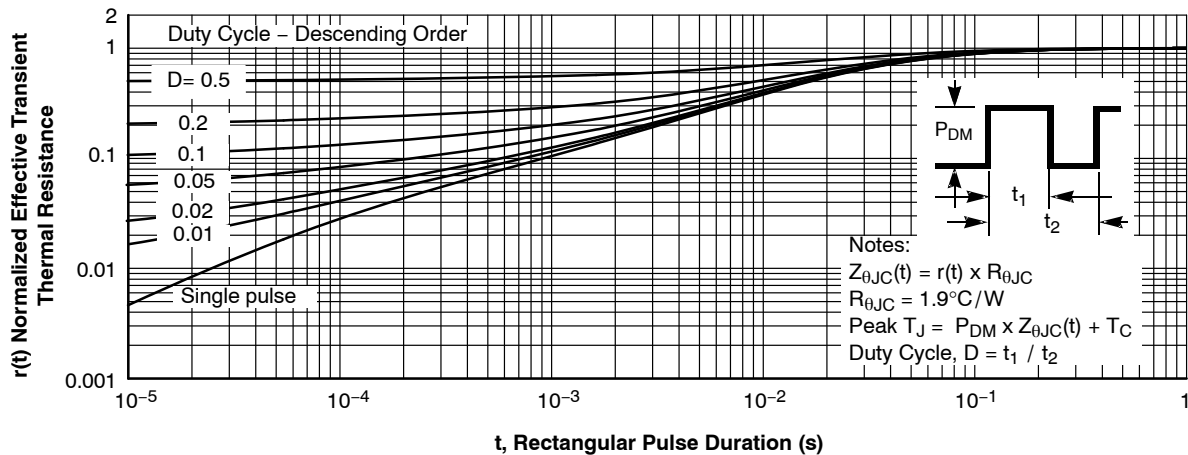

Figure 13. Junction-to-Case Transient Thermal Response Curve

ORDERING INFORMATION

Device	Device Marking	Package	Reel Size	Tape Width	Shipping [†]
FDMT1D3N08B	5F	PQFN8 8X8, 2P, (DUAL COOL 88)	13"	13.3 mm	3000 / Tape & Reel

[†]For information on tape and reel specifications, including part orientation and tape sizes, please refer to our Tape and Reel Packaging Specifications Brochure, [BRD8011/D](#).

POWERTRENCH and DUAL COOL are registered trademarks of Semiconductor Components Industries, LLC dba "onsemi" or its affiliates and/or subsidiaries in the United States and/or other countries.

MECHANICAL CASE OUTLINE PACKAGE DIMENSIONS

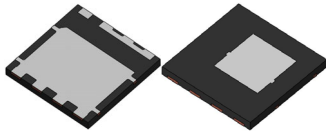

PQFN8 8X8, 2P
CASE 483AQ
ISSUE B

DATE 24 OCT 2022

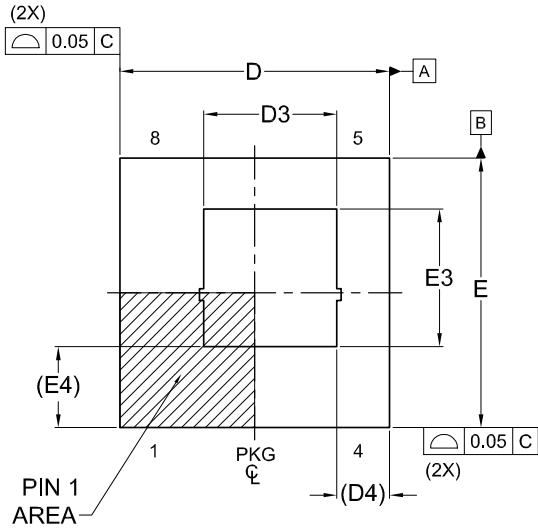

TOP VIEW

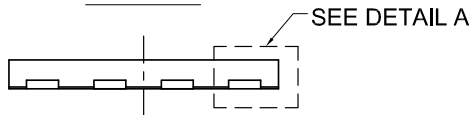

FRONT VIEW

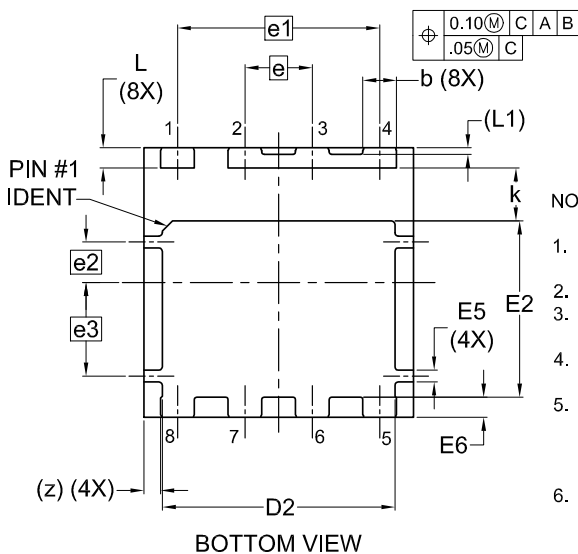

BOTTOM VIEW

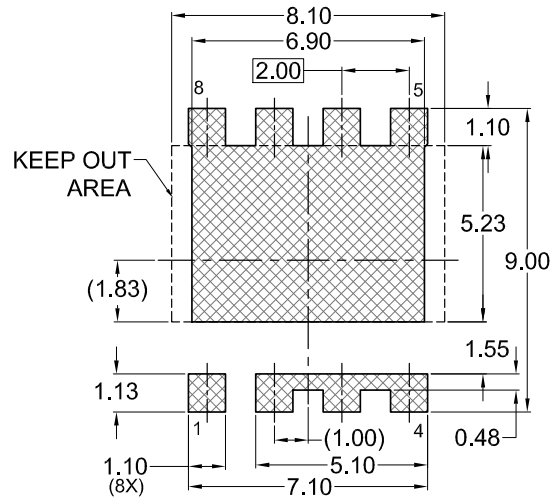

LAND PATTERN RECOMMENDATION

*FOR ADDITIONAL INFORMATION ON OUR PB-FREE STRATEGY AND SOLDERING DETAILS, PLEASE DOWNLOAD THE ON SEMICONDUCTOR SOLDERING AND MOUNTING TECHNIQUES REFERENCE MANUAL, SOLDERRM/D.

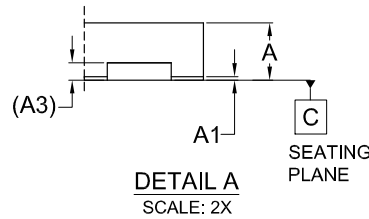

DETAIL A
SCALE: 2X

NOTES:

1. DIMENSIONING AND TOLERANCING PER ASME Y14.5M, 2009.
2. CONTROLLING DIMENSION: MILLIMETERS
3. COPLANARITY APPLIES TO THE EXPOSED PADS AS WELL AS THE TERMINALS.
4. DIMENSIONS D1 AND E1 DO NOT INCLUDE MOLD FLASH, PROTRUSIONS, OR GATE BURRS.
5. SEATING PLANE IS DEFINED BY THE TERMINALS. "A1" IS DEFINED AS THE DISTANCE FROM THE SEATING PLANE TO THE LOWEST POINT ON THE PACKAGE BODY.
6. IT IS RECOMMENDED TO HAVE NO TRACES OR VIAS WITHIN THE KEEP OUT AREA.

DIM	MILLIMETERS		
	MIN.	NOM.	MAX.
A	0.75	0.85	0.95
A1	0.00	-	0.05
A3	0.25 REF		
b	0.90	1.00	1.10
D	7.90	8.00	8.10
D2	6.80	6.90	7.00
D3	3.68	3.86	4.03
D4	1.56 REF		
E	7.90	8.00	8.10
E2	5.13	5.23	5.33
E3	3.99	4.09	4.19
E4	2.41 REF		
E5	0.35 REF		
E6	0.60 REF		
e	2.00 BSC		
e1	6.00 BSC		
e2	1.20 BSC		
e3	2.78 BSC		
k	1.48	1.58	1.68
L	0.50	0.60	0.70
L1	0.20 REF		
z	0.50 REF		

DOCUMENT NUMBER:	98AON13665G	Electronic versions are uncontrolled except when accessed directly from the Document Repository. Printed versions are uncontrolled except when stamped "CONTROLLED COPY" in red.
DESCRIPTION:	PQFN8 8X8, 2P	PAGE 1 OF 1

onsemi and ONSEMI are trademarks of Semiconductor Components Industries, LLC dba onsemi or its subsidiaries in the United States and/or other countries. onsemi reserves the right to make changes without further notice to any products herein. onsemi makes no warranty, representation or guarantee regarding the suitability of its products for any particular purpose, nor does onsemi assume any liability arising out of the application or use of any product or circuit, and specifically disclaims any and all liability, including without limitation special, consequential or incidental damages. onsemi does not convey any license under its patent rights nor the rights of others.

onsemi, **Onsemi**, and other names, marks, and brands are registered and/or common law trademarks of Semiconductor Components Industries, LLC dba "**onsemi**" or its affiliates and/or subsidiaries in the United States and/or other countries. **onsemi** owns the rights to a number of patents, trademarks, copyrights, trade secrets, and other intellectual property. A listing of **onsemi**'s product/patent coverage may be accessed at www.onsemi.com/site/pdf/Patent-Marking.pdf. **onsemi** reserves the right to make changes at any time to any products or information herein, without notice. The information herein is provided "as-is" and **onsemi** makes no warranty, representation or guarantee regarding the accuracy of the information, product features, availability, functionality, or suitability of its products for any particular purpose, nor does **onsemi** assume any liability arising out of the application or use of any product or circuit, and specifically disclaims any and all liability, including without limitation special, consequential or incidental damages. Buyer is responsible for its products and applications using **onsemi** products, including compliance with all laws, regulations and safety requirements or standards, regardless of any support or applications information provided by **onsemi**. "Typical" parameters which may be provided in **onsemi** data sheets and/or specifications can and do vary in different applications and actual performance may vary over time. All operating parameters, including "Typicals" must be validated for each customer application by customer's technical experts. **onsemi** does not convey any license under any of its intellectual property rights nor the rights of others. **onsemi** products are not designed, intended, or authorized for use as a critical component in life support systems or any FDA Class 3 medical devices or medical devices with a same or similar classification in a foreign jurisdiction or any devices intended for implantation in the human body. Should Buyer purchase or use **onsemi** products for any such unintended or unauthorized application, Buyer shall indemnify and hold **onsemi** and its officers, employees, subsidiaries, affiliates, and distributors harmless against all claims, costs, damages, and expenses, and reasonable attorney fees arising out of, directly or indirectly, any claim of personal injury or death associated with such unintended or unauthorized use, even if such claim alleges that **onsemi** was negligent regarding the design or manufacture of the part. **onsemi** is an Equal Opportunity/Affirmative Action Employer. This literature is subject to all applicable copyright laws and is not for resale in any manner.

ADDITIONAL INFORMATION

TECHNICAL PUBLICATIONS:

Technical Library: www.onsemi.com/design/resources/technical-documentation
onsemi Website: www.onsemi.com

ONLINE SUPPORT: www.onsemi.com/support

For additional information, please contact your local Sales Representative at www.onsemi.com/support/sales

