

IGBT - Power, Co-PAK N-Channel, Field Stop IV, MQ (Medium Speed), TO247-4L 650 V, 1.45 V, 50 A

FGH4L50T65MQDC50

Using the novel field stop 4th generation IGBT technology and generation 1.5 SiC Schottky Diode technology in TO-247 4-lead package, FGH4L50T65MQDC50 offers the optimum performance with both low conduction and switching losses for high-efficiency operations in various applications, especially totem pole bridgeless PFC and Inverter.

Features

- Positive Temperature Coefficient for Easy Parallel Operation
- High Current Capability
- 100% of the Parts are Tested for I_{LM} (Note 2)
- Smooth and Optimized Switching
- Low Saturation Voltage: $V_{CE(sat)} = 1.45\text{ V (Typ.) @ } I_C = 50\text{ A}$
- No Reverse Recovery / No Forward Recovery
- Tight Parameter Distribution
- RoHS Compliant

Applications

- Charging Station (EVSE)
- Solar Inverter
- UPS, ESS
- PFC, Converters

MAXIMUM RATINGS ($T_J = 25^\circ\text{C}$ unless otherwise noted)

Parameter	Symbol	Value	Unit	
Collector-to-Emitter Voltage	V_{CES}	650	V	
Gate-to-Emitter Voltage	V_{GES}	± 20		
Transient Gate-to-Emitter Voltage ($t_p < 0.5\ \mu\text{s}$, $D < 0.001$)		± 30		
Collector Current	I_C	$T_C = 25^\circ\text{C}$ (Note 1)	100	A
		$T_C = 100^\circ\text{C}$	50	
Power Dissipation	P_D	$T_C = 25^\circ\text{C}$	246	W
		$T_C = 100^\circ\text{C}$	123	
Pulsed Collector Current	I_{LM}	$T_C = 25^\circ\text{C}$ (Note 2)	200	A
		$T_C = 25^\circ\text{C}$ (Note 3)	I_{CM}	200
Diode Forward Current	I_F	$T_C = 25^\circ\text{C}$ (Note 1)	60	A
		$T_C = 100^\circ\text{C}$	50	
Pulsed Diode Maximum Forward Current	I_{FM}	200	A	
Operating Junction and Storage Temperature Range	T_J , T_{STG}	-55 to +175	$^\circ\text{C}$	
Maximum Lead Temp. for Soldering Purposes (1/8" from case for 5 s)	T_L	260	$^\circ\text{C}$	

Stresses exceeding those listed in the Maximum Ratings table may damage the device. If any of these limits are exceeded, device functionality should not be assumed, damage may occur and reliability may be affected.

1. Value limit by bond wire
2. $V_{CC} = 400\text{ V}$, $V_{GE} = 15\text{ V}$, $I_C = 200\text{ A}$, Inductive Load, 100% tested
3. Repetitive rating: pulse width limited by max. junction temperature

BV_{CES}	$V_{CE(sat)}$	I_C
650 V	1.45 V	50 A

PIN CONNECTIONS

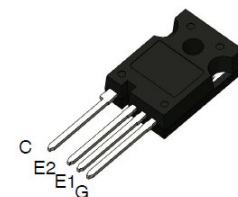
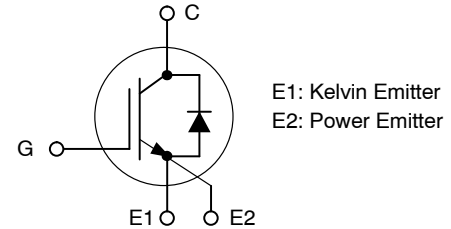

TO-247-4LD
CASE 340CJ

MARKING DIAGRAM

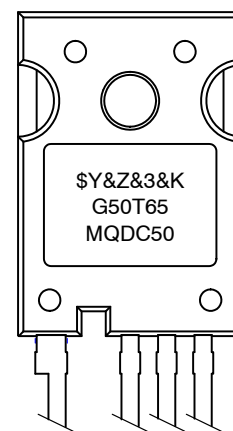

\$Y = onsemi Logo
&Z = Assembly Plant Code
&3 = 3-Digit Date Code
&K = 2-Digit Lot Traceability Code
G50T65MQDC50 = Specific Device Code

ORDERING INFORMATION

Device	Package	Shipping
FGH4L50T65MQDC50	TO-247 -4LD	30 Units / Tube

FGH4L50T65MQDC50

THERMAL CHARACTERISTICS

Rating	Symbol	Value	Unit
Thermal Resistance Junction-to-Case, for IGBT	$R_{\theta JC}$	0.61	°C/W
Thermal Resistance Junction-to-Case, for Diode	$R_{\theta JCD}$	0.70	
Thermal Resistance junction-to-Ambient	$R_{\theta JA}$	40	

ELECTRICAL CHARACTERISTICS ($T_J = 25^\circ\text{C}$ unless otherwise noted)

Parameter	Test Conditions	Symbol	Min	Typ	Max	Unit
-----------	-----------------	--------	-----	-----	-----	------

OFF CHARACTERISTICS

Collector-emitter Breakdown Voltage, Gate-emitter Short-circuited	$V_{GE} = 0\text{ V}, I_C = 1\text{ mA}$	BV_{CES}	650	-	-	V
Temperature Coefficient of Breakdown Voltage	$V_{GE} = 0\text{ V}, I_C = 1\text{ mA}$	$\frac{\Delta BV_{CES}}{\Delta T_J}$	-	0.5	-	V/°C
Collector-emitter Cut-off Current, Gate-emitter Short-circuited	$V_{GE} = 0\text{ V}, V_{CE} = 650\text{ V}$	I_{CES}	-	-	250	μA
Gate Leakage Current, Collector-emitter Short-circuited	$V_{GE} = 20\text{ V}, V_{CE} = 0\text{ V}$	I_{GES}	-	-	±400	nA

ON CHARACTERISTICS

Gate-emitter Threshold Voltage	$V_{GE} = V_{CE}, I_C = 50\text{ mA}$	$V_{GE(th)}$	3.0	4.5	6.0	V
Collector-emitter Saturation Voltage	$V_{GE} = 15\text{ V}, I_C = 50\text{ A}, T_J = 25^\circ\text{C}$	$V_{CE(sat)}$	-	1.45	1.8	V
	$V_{GE} = 15\text{ V}, I_C = 50\text{ A}, T_J = 175^\circ\text{C}$		-	1.65	-	

DYNAMIC CHARACTERISTICS

Input Capacitance	$V_{CE} = 30\text{ V}, V_{GE} = 0\text{ V}, f = 1\text{ MHz}$	C_{ies}	-	3340	-	pF
Output Capacitance		C_{oes}	-	630	-	
Reverse Transfer Capacitance		C_{res}	-	10	-	
Gate Charge Total	$V_{CE} = 400\text{ V}, I_C = 50\text{ A}, V_{GE} = 15\text{ V}$	Q_g	-	102	-	nC
Gate-to-emitter Charge		Q_{ge}	-	19	-	
Gate-to-collector Charge		Q_{gc}	-	25	-	

SWITCHING CHARACTERISTICS, INDUCTIVE LOAD

Turn-on Delay Time	$T_J = 25^\circ\text{C}, V_{CC} = 400\text{ V}, I_C = 25\text{ A}, R_G = 15\ \Omega, V_{GE} = 15\text{ V}, \text{Inductive Load}$	$t_{d(on)}$	-	27	-	ns
Rise Time		t_r	-	10	-	
Turn-off Delay Time		$t_{d(off)}$	-	181	-	
Fall Time		t_f	-	21	-	mJ
Turn-on Switching Loss		E_{on}	-	0.24	-	
Turn-off Switching Loss		E_{off}	-	0.31	-	
Total Switching Loss		E_{ts}	-	0.55	-	
Turn-on Delay Time	$T_J = 25^\circ\text{C}, V_{CC} = 400\text{ V}, I_C = 50\text{ A}, R_G = 15\ \Omega, V_{GE} = 15\text{ V}, \text{Inductive Load}$	$t_{d(on)}$	-	29	-	ns
Rise Time		t_r	-	21	-	
Turn-off Delay Time		$t_{d(off)}$	-	173	-	
Fall Time		t_f	-	18	-	mJ
Turn-on Switching Loss		E_{on}	-	0.54	-	
Turn-off Switching Loss		E_{off}	-	0.59	-	
Total Switching Loss		E_{ts}	-	1.13	-	

FGH4L50T65MQDC50

ELECTRICAL CHARACTERISTICS ($T_J = 25^\circ\text{C}$ unless otherwise noted)

Parameter	Test Conditions	Symbol	Min	Typ	Max	Unit
-----------	-----------------	--------	-----	-----	-----	------

SWITCHING CHARACTERISTICS, INDUCTIVE LOAD

Turn-on Delay Time	$T_J = 175^\circ\text{C}, V_{CC} = 400\text{ V},$ $I_C = 25\text{ A}, R_G = 15\ \Omega,$ $V_{GE} = 15\text{ V},$ Inductive Load	$t_{d(on)}$	-	24	-	ns
Rise Time		t_r	-	11	-	
Turn-off Delay Time		$t_{d(off)}$	-	197	-	
Fall Time		t_f	-	24	-	
Turn-on Switching Loss		E_{on}	-	0.31	-	mJ
Turn-off Switching Loss		E_{off}	-	0.51	-	
Total Switching Loss		E_{ts}	-	0.82	-	
Turn-on Delay Time	$T_J = 175^\circ\text{C}, V_{CC} = 400\text{ V},$ $I_C = 50\text{ A}, R_G = 15\ \Omega,$ $V_{GE} = 15\text{ V},$ Inductive Load	$t_{d(on)}$	-	26	-	ns
Rise Time		t_r	-	27	-	
Turn-off Delay Time		$t_{d(off)}$	-	186	-	
Fall Time		t_f	-	26	-	
Turn-on Switching Loss		E_{on}	-	0.74	-	mJ
Turn-off Switching Loss		E_{off}	-	0.97	-	
Total Switching Loss		E_{ts}	-	1.71	-	

DIODE CHARACTERISTICS

Diode Forward Voltage	$I_F = 50\text{ A}, T_J = 25^\circ\text{C}$	V_F	-	1.46	1.7	V
	$I_F = 50\text{ A}, T_J = 175^\circ\text{C}$		-	1.83	-	
Total Capacitance	$V_R = 400\text{ V}, f = 1\text{ MHz}, T_J = 25^\circ\text{C}$	C	-	210	-	pF
	$V_R = 600\text{ V}, f = 1\text{ MHz}, T_J = 25^\circ\text{C}$		-	202	-	

Product parametric performance is indicated in the Electrical Characteristics for the listed test conditions, unless otherwise noted. Product performance may not be indicated by the Electrical Characteristics if operated under different conditions.

FGH4L50T65MQDC50

TYPICAL CHARACTERISTICS

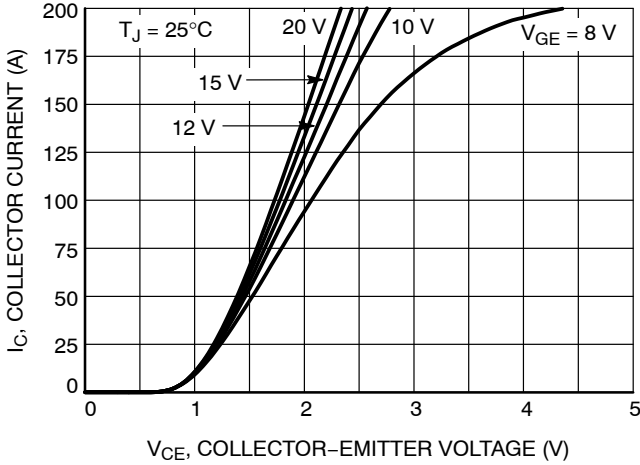

Figure 1. Typical Output Characteristics

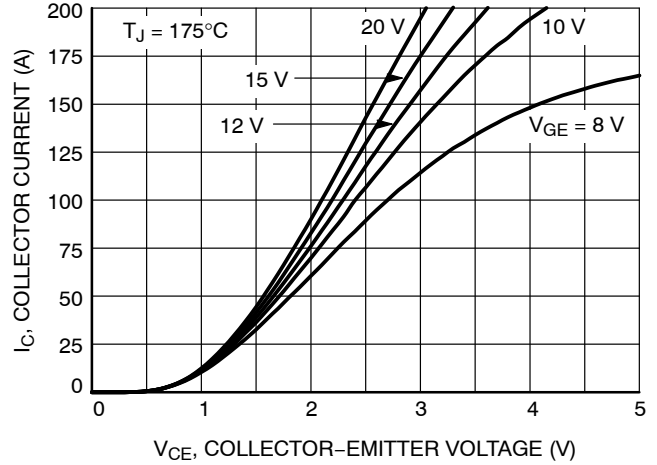

Figure 2. Typical Output Characteristics

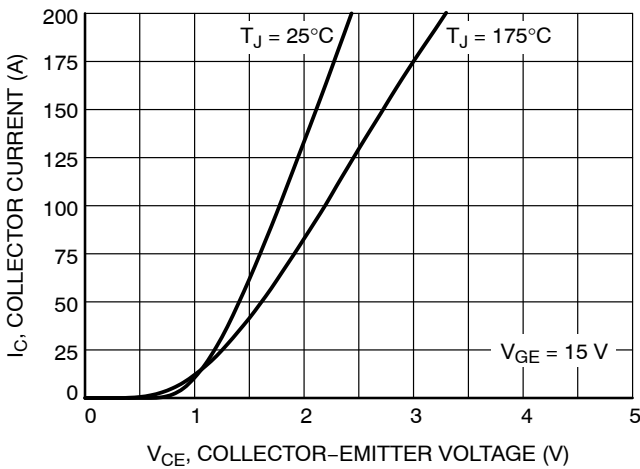

Figure 3. Typical Output Characteristics

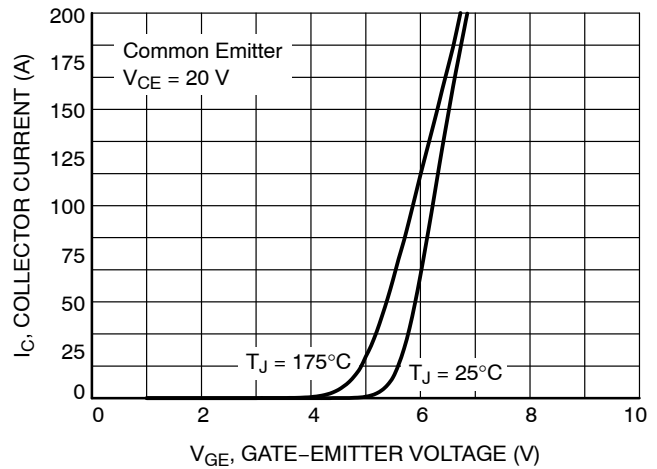

Figure 4. Transfer Characteristics

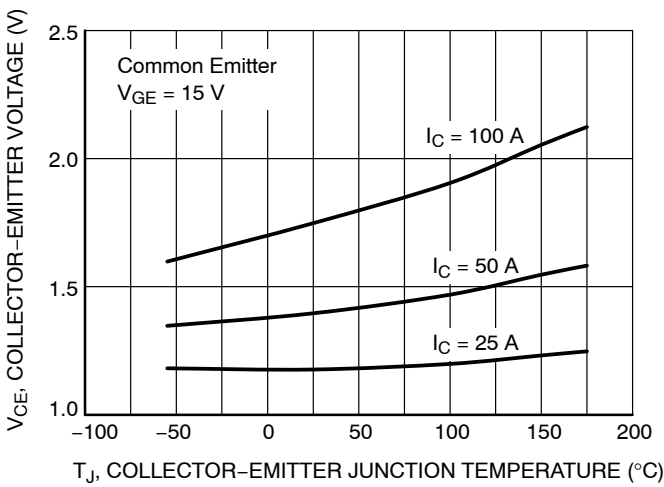

Figure 5. Saturation Voltage vs. Junction Temperature at Variant Current Level

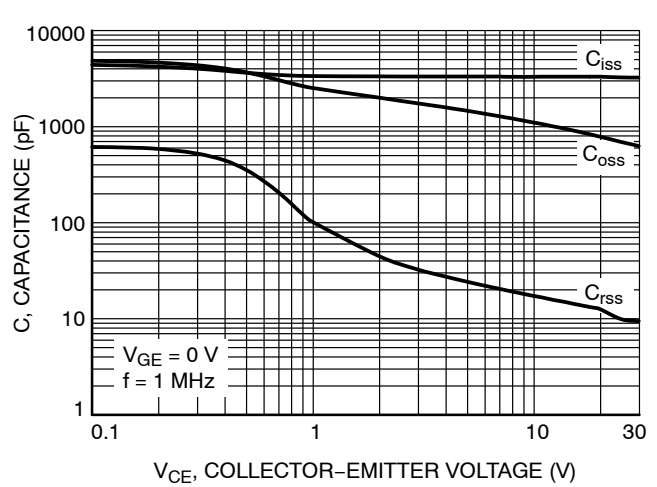

Figure 6. Capacitance Variation

FGH4L50T65MQDC50

TYPICAL CHARACTERISTICS

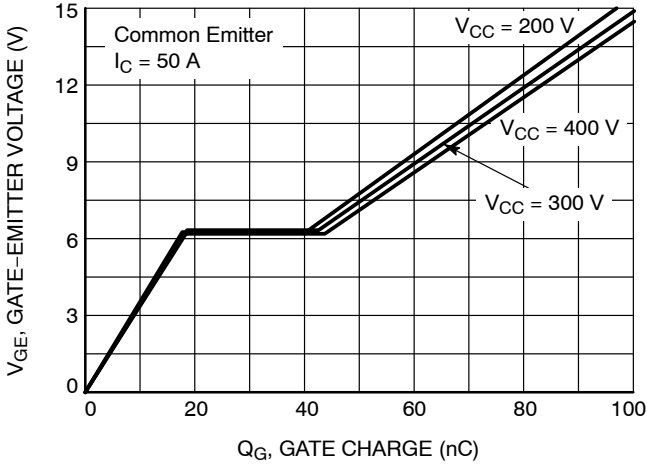

Figure 7. Gate Charge Characteristics

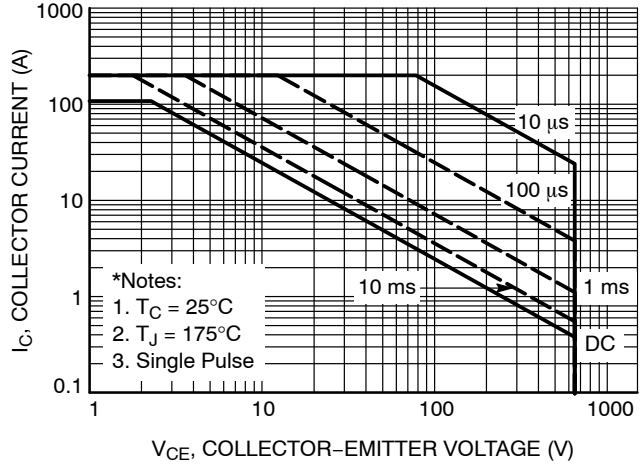

Figure 8. SOA Characteristics

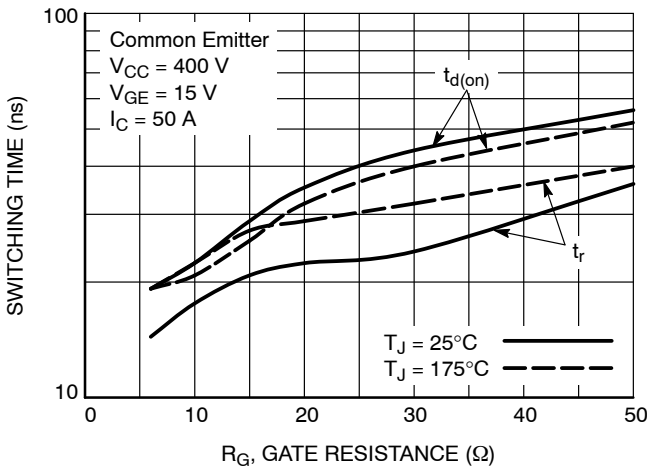

Figure 9. Turn-On Characteristics vs. Gate Resistance

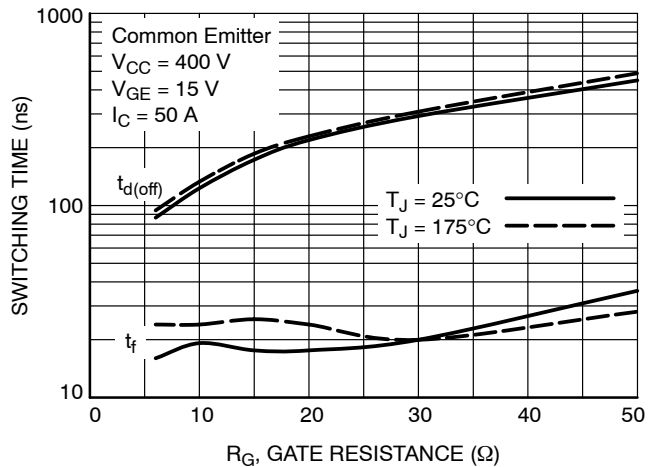

Figure 10. Turn-Off Characteristics vs. Gate Resistance

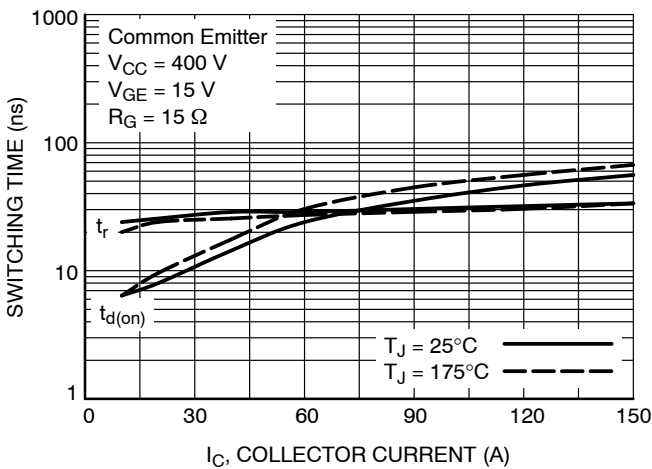

Figure 11. Turn-on Characteristics vs. Collector Current

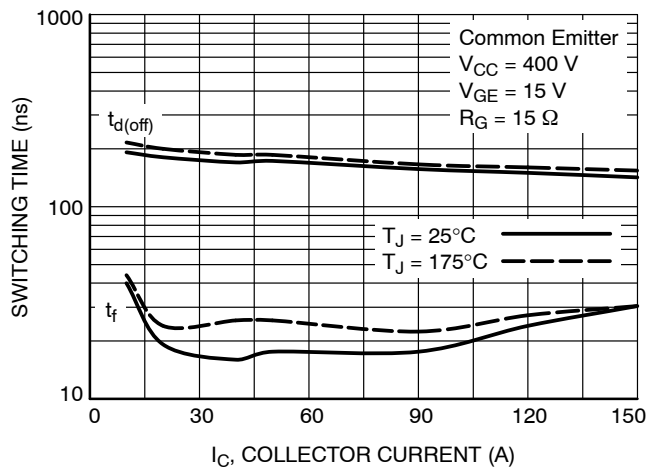

Figure 12. Turn-off Characteristics vs. Collector Current

FGH4L50T65MQDC50

TYPICAL CHARACTERISTICS

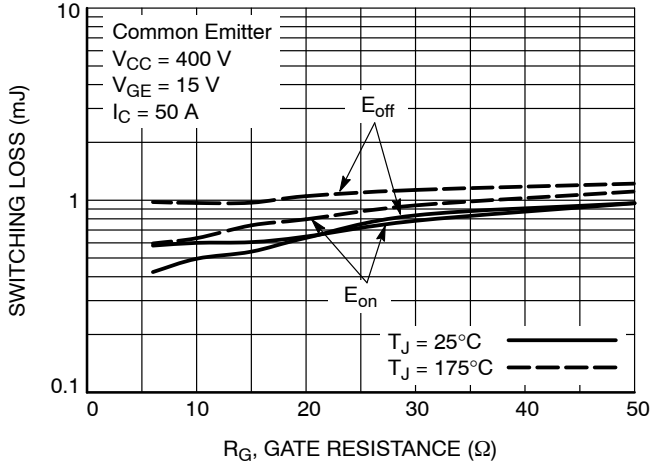

Figure 13. Switching Loss vs. Gate Resistance

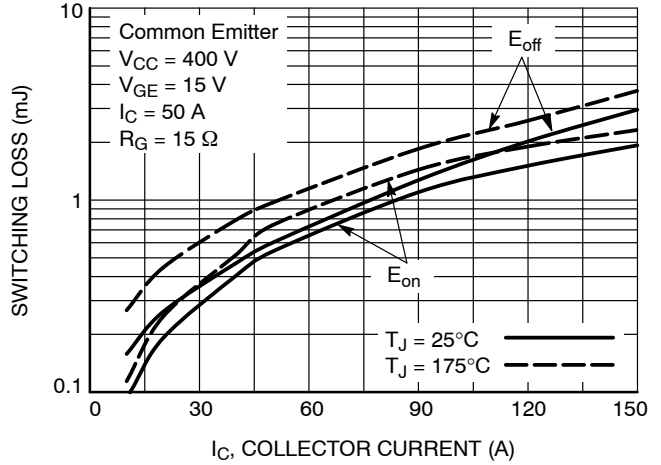

Figure 14. Switching Loss vs. Collector Current

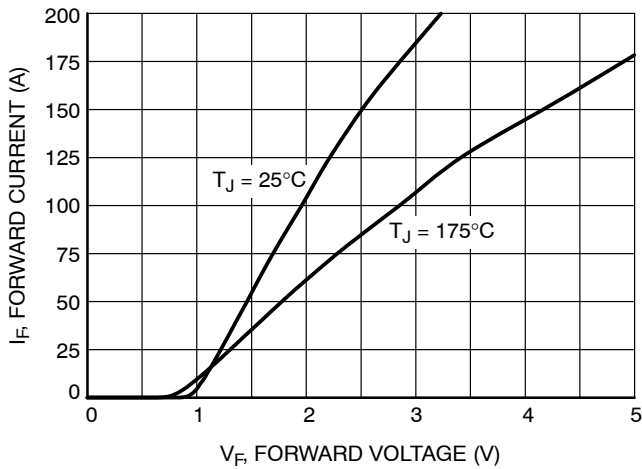

Figure 15. Forward Diode Characteristics

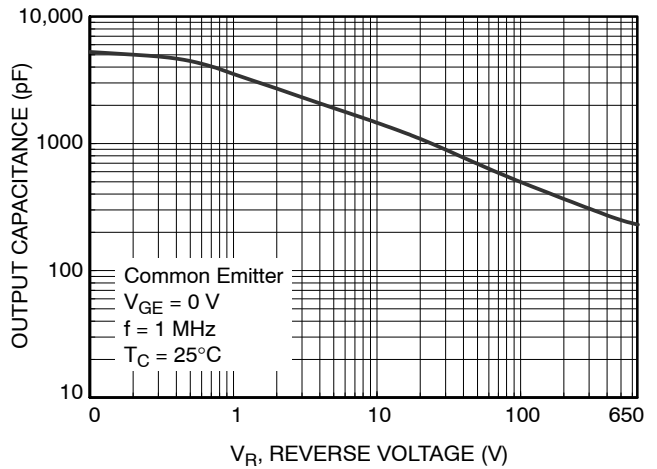

Figure 16. (Diode) Output Capacitance (Coes) vs. Reverse Voltage

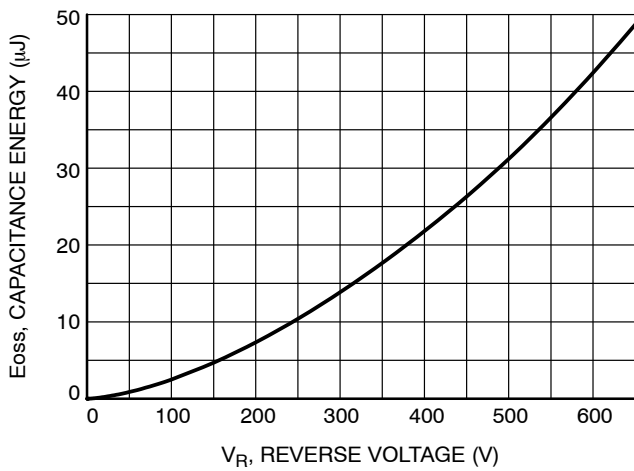

Figure 17. Output Capacitance Stored Energy

FGH4L50T65MQDC50

TYPICAL CHARACTERISTICS

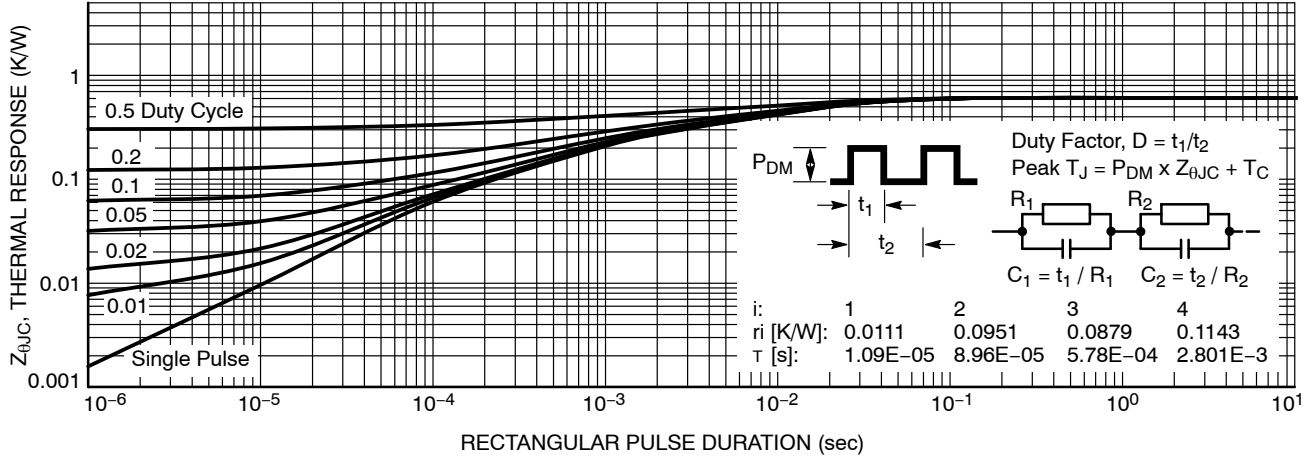

Figure 18. Transient Thermal Impedance of IGBT

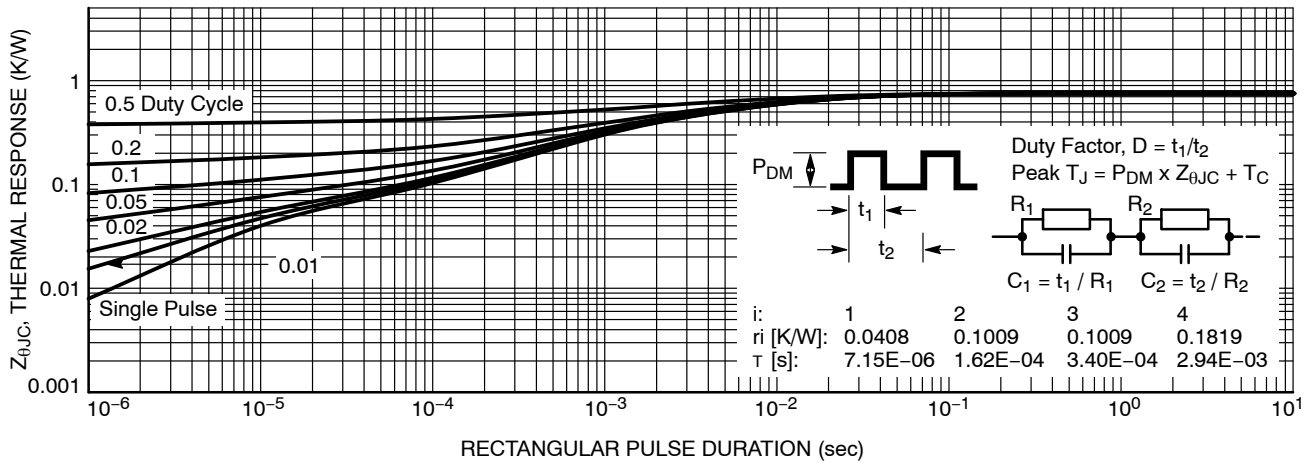
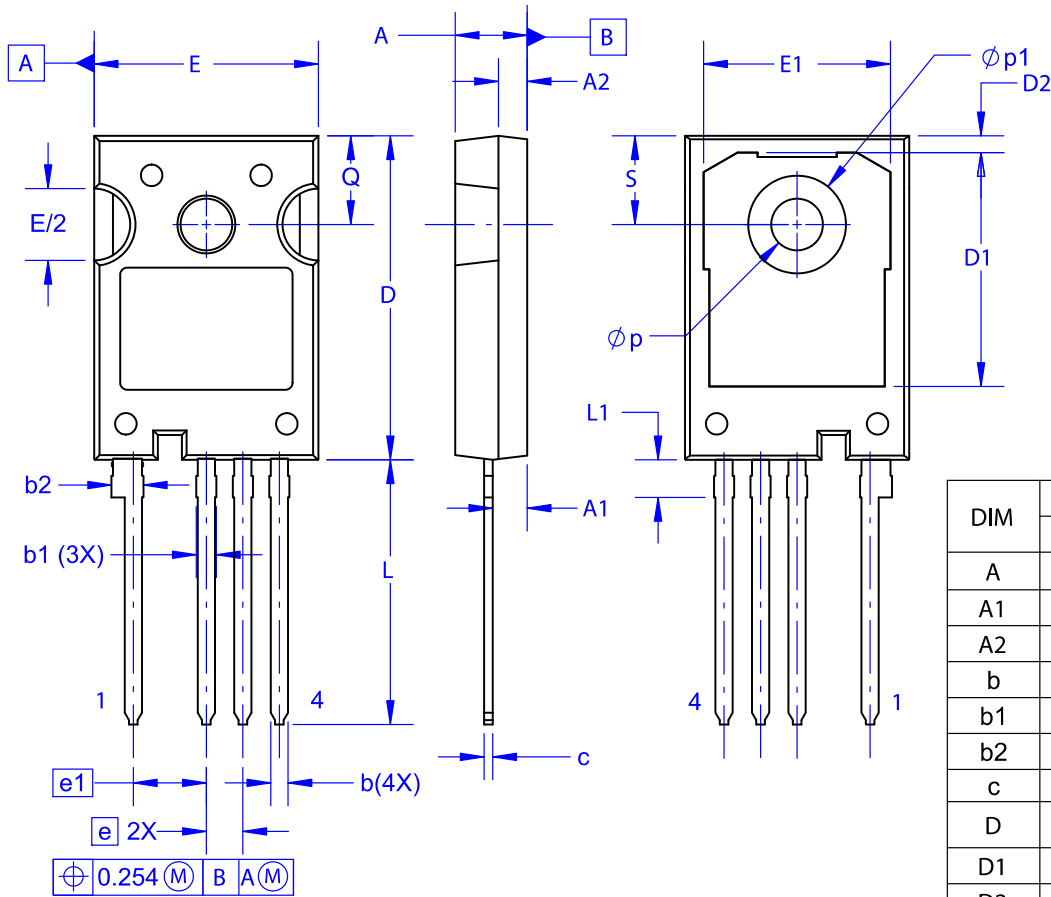

Figure 19. Transient Thermal Impedance of Diode

TO-247-4LD
CASE 340CJ
ISSUE A

DATE 16 SEP 2019



DIM	MILLIMETERS		
	MIN	NOM	MAX
A	4.80	5.00	5.20
A1	2.10	2.40	2.70
A2	1.80	2.00	2.20
b	1.07	1.20	1.33
b1	1.20	1.40	1.60
b2	2.02	2.22	2.42
c	0.50	0.60	0.70
D	22.34	22.54	22.74
D1	16.00	16.25	16.50
D2	0.97	1.17	1.37
e	2.54 BSC		
e1	5.08 BSC		
E	15.40	15.60	15.80
E1	12.80	13.00	13.20
E/2	4.80	5.00	5.20
L	18.22	18.42	18.62
L1	2.42	2.62	2.82
p	3.40	3.60	3.80
p1	6.60	6.80	7.00
Q	5.97	6.17	6.37
S	5.97	6.17	6.37

NOTES:

- A. NO INDUSTRY STANDARD APPLIES TO THIS PACKAGE.
- B. DIMENSIONS ARE EXCLUSIVE OF BURRS, MOLD FLASH, AND TIE BAR EXTRUSIONS.
- C. ALL DIMENSIONS ARE IN MILLIMETERS.
- D. DRAWING CONFORMS TO ASME Y14.5-2009.

DOCUMENT NUMBER:	98AON13852G	Electronic versions are uncontrolled except when accessed directly from the Document Repository. Printed versions are uncontrolled except when stamped "CONTROLLED COPY" in red.
DESCRIPTION:	TO-247-4LD	PAGE 1 OF 1

onsemi and Onsemi are trademarks of Semiconductor Components Industries, LLC dba onsemi or its subsidiaries in the United States and/or other countries. onsemi reserves the right to make changes without further notice to any products herein. onsemi makes no warranty, representation or guarantee regarding the suitability of its products for any particular purpose, nor does onsemi assume any liability arising out of the application or use of any product or circuit, and specifically disclaims any and all liability, including without limitation special, consequential or incidental damages. onsemi does not convey any license under its patent rights nor the rights of others.

onsemi, **Onsemi**, and other names, marks, and brands are registered and/or common law trademarks of Semiconductor Components Industries, LLC dba "**onsemi**" or its affiliates and/or subsidiaries in the United States and/or other countries. **onsemi** owns the rights to a number of patents, trademarks, copyrights, trade secrets, and other intellectual property. A listing of **onsemi**'s product/patent coverage may be accessed at www.onsemi.com/site/pdf/Patent-Marking.pdf. **onsemi** reserves the right to make changes at any time to any products or information herein, without notice. The information herein is provided "as-is" and **onsemi** makes no warranty, representation or guarantee regarding the accuracy of the information, product features, availability, functionality, or suitability of its products for any particular purpose, nor does **onsemi** assume any liability arising out of the application or use of any product or circuit, and specifically disclaims any and all liability, including without limitation special, consequential or incidental damages. Buyer is responsible for its products and applications using **onsemi** products, including compliance with all laws, regulations and safety requirements or standards, regardless of any support or applications information provided by **onsemi**. "Typical" parameters which may be provided in **onsemi** data sheets and/or specifications can and do vary in different applications and actual performance may vary over time. All operating parameters, including "Typicals" must be validated for each customer application by customer's technical experts. **onsemi** does not convey any license under any of its intellectual property rights nor the rights of others. **onsemi** products are not designed, intended, or authorized for use as a critical component in life support systems or any FDA Class 3 medical devices or medical devices with a same or similar classification in a foreign jurisdiction or any devices intended for implantation in the human body. Should Buyer purchase or use **onsemi** products for any such unintended or unauthorized application, Buyer shall indemnify and hold **onsemi** and its officers, employees, subsidiaries, affiliates, and distributors harmless against all claims, costs, damages, and expenses, and reasonable attorney fees arising out of, directly or indirectly, any claim of personal injury or death associated with such unintended or unauthorized use, even if such claim alleges that **onsemi** was negligent regarding the design or manufacture of the part. **onsemi** is an Equal Opportunity/Affirmative Action Employer. This literature is subject to all applicable copyright laws and is not for resale in any manner.

ADDITIONAL INFORMATION

TECHNICAL PUBLICATIONS:

Technical Library: www.onsemi.com/design/resources/technical-documentation
onsemi Website: www.onsemi.com

ONLINE SUPPORT: www.onsemi.com/support

For additional information, please contact your local Sales Representative at www.onsemi.com/support/sales