

# MOSFET – N-Channel QFET®

600 V, 0.3 A, 11.5 Ω

## FQN1N60C

### Description

This N-Channel enhancement mode power MOSFET is produced using ON Semiconductor's proprietary planar stripe and DMOS technology. This advanced MOSFET technology has been especially tailored to reduce on-state resistance, and to provide superior switching performance and high avalanche energy strength. These devices are suitable for switched mode power supplies, active power factor correction (PFC), and electronic lamp ballasts.

### Features

- 0.3 A, 600 V,  $R_{DS(on)} = 11.5 \Omega$  (Max.) @  $V_{GS} = 10 V$ ,  $I_D = 0.15 A$
- Low Gate Charge (Typ. 4.8 nC)
- Low  $C_{rss}$  (Typ. 3.5 pF)
- 100% Avalanche Tested

### ABSOLUTE MAXIMUM RATINGS ( $T_C = 25^\circ C$ unless otherwise noted)

Symbol	Parameter	Value	Unit
$V_{DSS}$	Drain to Source Voltage	600	V
$V_{GSS}$	Gate to Source Voltage	$\pm 30$	V
$I_D$	Drain Current Continuous ( $T_C = 25^\circ C$ ) Continuous ( $T_C = 100^\circ C$ )	0.3 0.18	A
$I_{DM}$	Drain Current – Pulsed (Note 1)	1.2	A
$E_{AS}$	Single Pulsed Avalanche Energy (Note 2)	33	mJ
$I_{AR}$	Avalanche Current (Note 1)	0.3	A
$E_{AR}$	Repetitive Avalanche Energy (Note 1)	0.3	mJ
dv/dt	Peak Diode Recovery dv/dt (Note 3)	4.5	V/ns
$P_D$	Power Dissipation ( $T_A = 25^\circ C$ ) ( $T_L = 25^\circ C$ ) Derate above $25^\circ C$	1 3 0.02	W W W/ $^\circ C$
$T_J, T_{STG}$	Operating and Storage Temperature Range	-55 to +150	$^\circ C$
$T_L$	Maximum Lead Temperature for Soldering, 1/8" from Case for 5 Seconds	300	$^\circ C$

Stresses exceeding those listed in the Maximum Ratings table may damage the device. If any of these limits are exceeded, device functionality should not be assumed, damage may occur and reliability may be affected.

1. Repetitive Rating: Pulse width limited by maximum junction temperature.
2.  $L = 59 mH$ ,  $I_{AS} = 1.1 A$ ,  $V_{DD} = 50 V$ ,  $R_G = 25 \Omega$ , Starting  $T_J = 25^\circ C$ .
3.  $I_{SD} \leq 0.3 A$ ,  $di/dt \leq 200 A/\mu s$ ,  $V_{DD} \leq BV_{DSS}$ , Starting  $T_J = 25^\circ C$ .



ON Semiconductor®

[www.onsemi.com](http://www.onsemi.com)

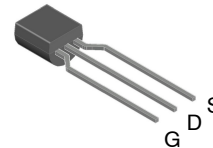

TO-92 4.75x4.80  
CASE 135AV

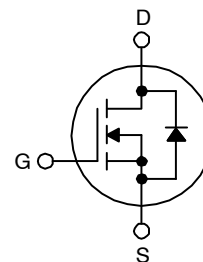

### MARKING DIAGRAM

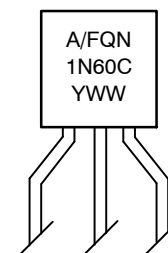

A = Assembly Site  
FQN1N60C = Specific Device Code  
Y = Year of Production  
WW = Work Week Number

### ORDERING INFORMATION

Device	Package	Shipping
FQN1N60CTA	TO-92 3LD	2000 / Fan-Fold

# FQN1N60C

## THERMAL CHARACTERISTICS

Symbol	Parameter	Value	Unit
$R_{\theta JL}$	Thermal Resistance, Junction-to-Lead, Max. (Note 5)	50	°C/W
$R_{\theta JA}$	Thermal Resistance, Junction-to-Ambient, Max. (Note 6)	140	

## ELECTRICAL CHARACTERISTICS (T<sub>C</sub> = 25°C, unless otherwise noted)

Symbol	Parameter	Test Conditions	Min	Typ	Max	Unit
<b>OFF CHARACTERISTIC</b>						
$BV_{DSS}$	Drain to Source Breakdown Voltage	$I_D = 250 \mu A, V_{GS} = 0 V$	600	-	-	V
$\Delta BV_{DSS} / \Delta T_J$	Breakdown Voltage Temperature Coefficient	$I_D = 250 \mu A$ , Referenced to 25°C	-	0.6	-	V/°C
$I_{DSS}$	Zero Gate Voltage Drain Current	$V_{DS} = 600 V, V_{GS} = 0 V$	-	-	50	$\mu A$
		$V_{DS} = 480 V, T_C = 125^\circ C$	-	-	250	
$I_{GSSF}$	Gate to Body Leakage Current, Forward	$V_{GS} = 30 V, V_{DS} = 0 V$	-	-	100	nA
$I_{GSSR}$	Gate to Body Leakage Current, Reverse	$V_{GS} = -30 V, V_{DS} = 0 V$	-	-	-100	nA

## ON CHARACTERISTICS

$V_{GS(th)}$	Gate Threshold Voltage	$V_{GS} = V_{DS}, I_D = 250 \mu A$	2.0	-	4.0	V
$R_{DS(on)}$	Static Drain to Source On-Resistance	$V_{GS} = 10 V, I_D = 0.15 A$	-	9.3	11.5	$\Omega$
$g_{FS}$	Forward Transconductance	$V_{DS} = 40 V, I_D = 0.3 A$	-	0.75	-	S

## DYNAMIC CHARACTERISTICS

$C_{iss}$	Input Capacitance	$V_{DS} = 25 V, V_{GS} = 0 V, f = 1.0 MHz$	-	130	170	pF
$C_{oss}$	Output Capacitance		-	19	25	pF
$C_{rss}$	Reverse Transfer Capacitance		-	3.5	6	pF

## SWITCHING CHARACTERISTICS

$t_{d(on)}$	Turn-On Delay Time	$V_{DD} = 300 V, I_D = 1.1 A, R_G = 25 \Omega$ (Note 4)	-	7	24	ns
$t_r$	Turn-On Rise Time		-	21	52	ns
$t_{d(off)}$	Turn-Off Delay Time		-	13	36	ns
$t_f$	Turn-Off Fall Time		-	27	64	ns
$Q_g$	Total Gate Charge	$V_{DS} = 480 V, I_D = 1.1 A, V_{GS} = 10 V$ (Note 4)	-	4.8	6.2	nC
$Q_{gs}$	Gate to Source Charge		-	0.7	-	nC
$Q_{gd}$	Gate to Drain Charge		-	2.7	-	nC

## DRAIN-SOURCE DIODE CHARACTERISTICS AND MAXIMUM RATINGS

$I_S$	Maximum Continuous Drain to Source Diode Forward Current	-	-	0.3	A	
$I_{SM}$	Maximum Pulsed Drain to Source Diode Forward Current	-	-	1.2	A	
$V_{SD}$	Drain to Source Diode Forward Voltage	$V_{GS} = 0 V, I_S = 0.3 A$	-	-	1.4	V
$t_{rr}$	Reverse Recovery Time	$V_{GS} = 0 V, I_S = 1.1 A, di_F/dt = 100 A/\mu s$	-	190	-	ns
$Q_{rr}$	Reverse Recovery Charge		-	0.53	-	$\mu C$

Product parametric performance is indicated in the Electrical Characteristics for the listed test conditions, unless otherwise noted. Product performance may not be indicated by the Electrical Characteristics if operated under different conditions.

- Essentially independent of operating temperature.
- Reference point of the  $R_{\theta JL}$  is the drain lead.
- When mounted on 3"x4.5" FR-4 PCB without any pad copper in a still air environment ( $R_{\theta JA}$  is the sum of the junction-to-case and case-to-ambient thermal resistance.  $R_{\theta CA}$  is determined by the user's board design)

TYPICAL CHARACTERISTICS

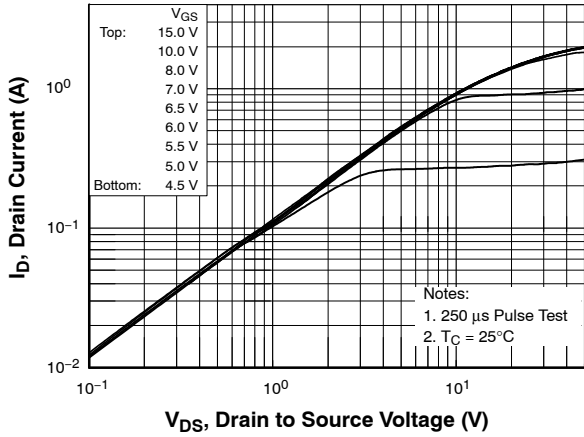

Figure 1. On-Region Characteristics

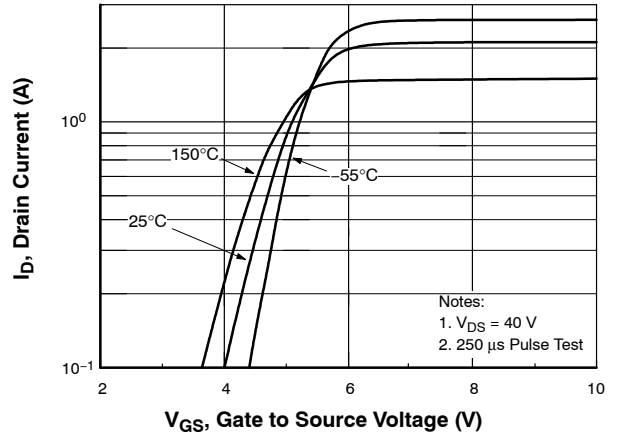

Figure 2. Transfer Characteristics

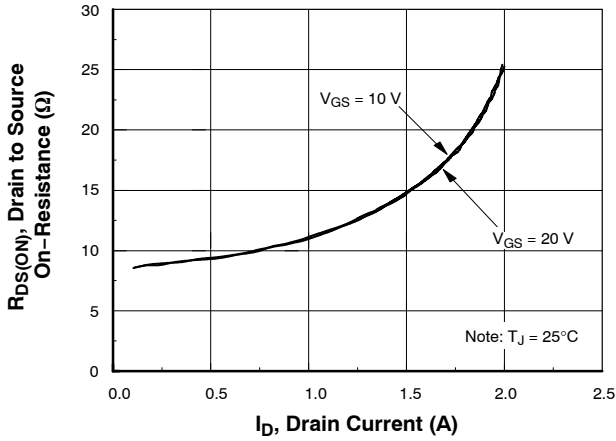

Figure 3. On-Resistance Variation vs. Drain Current and Gate Voltage

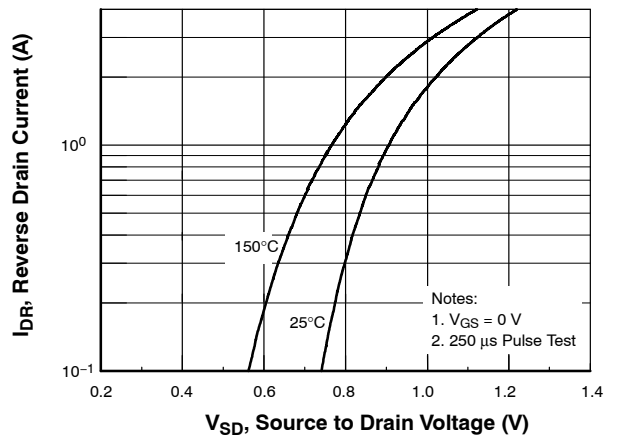

Figure 4. Body Diode Forward Voltage Variation vs. Source Current and Temperature

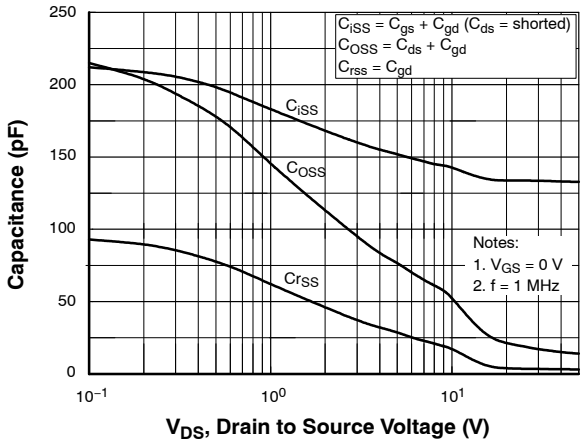

Figure 5. Capacitance Characteristics

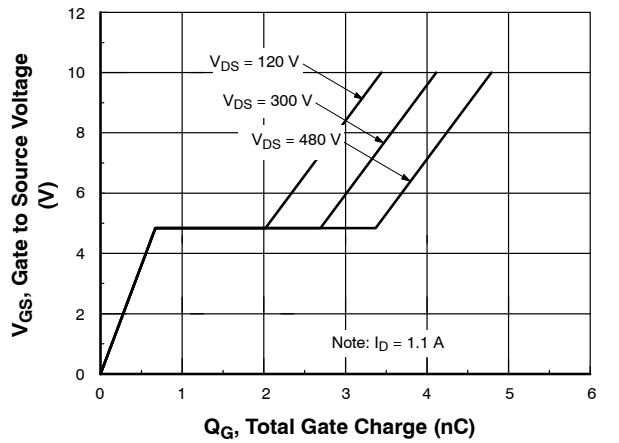

Figure 6. Gate Charge Characteristics

# FQN1N60C

## TYPICAL CHARACTERISTICS (Continued)

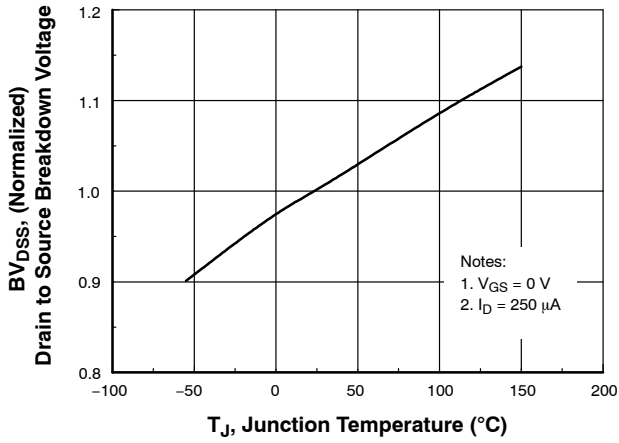

Figure 7. Breakdown Voltage Variation vs. Temperature

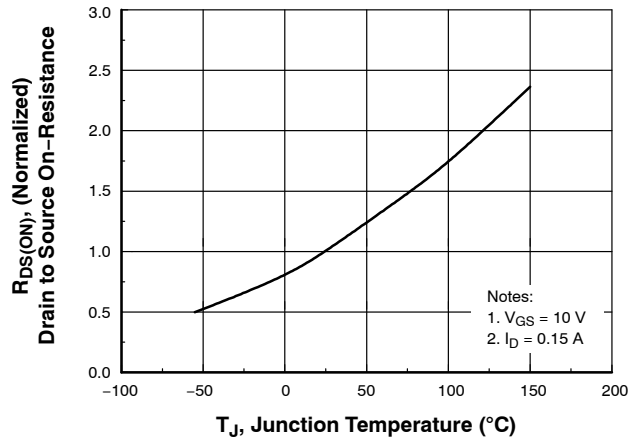

Figure 8. On-Resistance Variation vs. Temperature

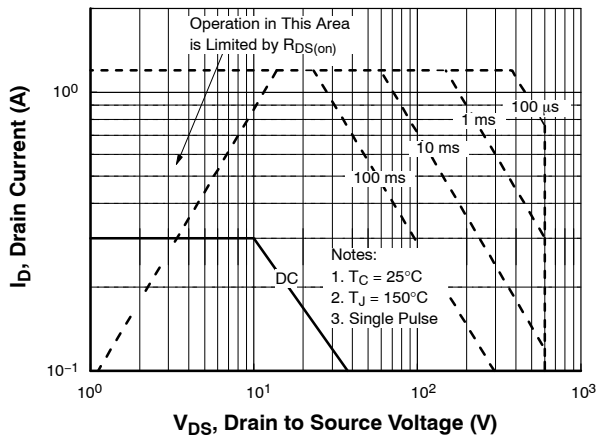

Figure 9. Maximum Safe Operating Area

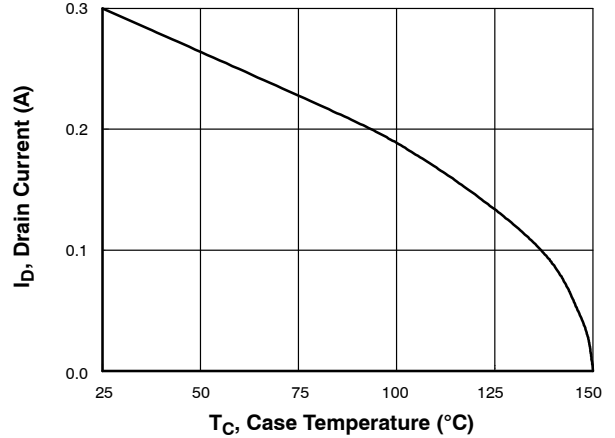

Figure 10. Maximum Drain Current vs. Case Temperature

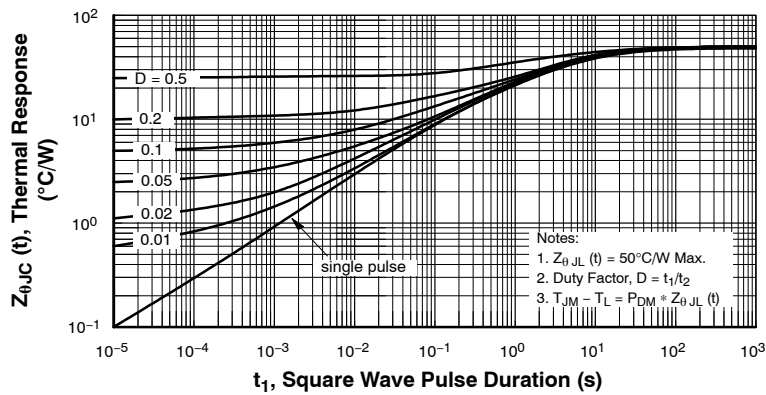

Figure 11. Transient Thermal Response Curve

# FQN1N60C

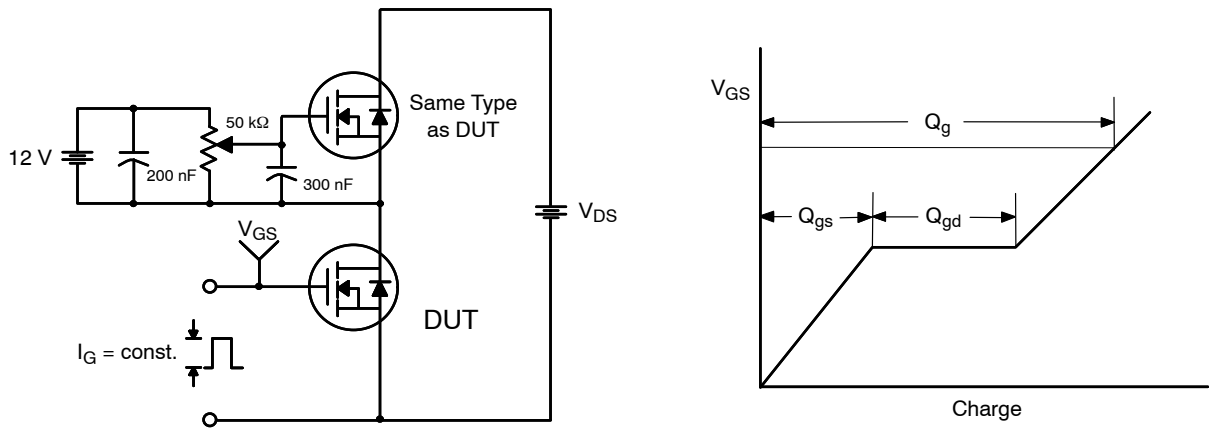

Figure 12. Gate Charge Test Circuit & Waveform

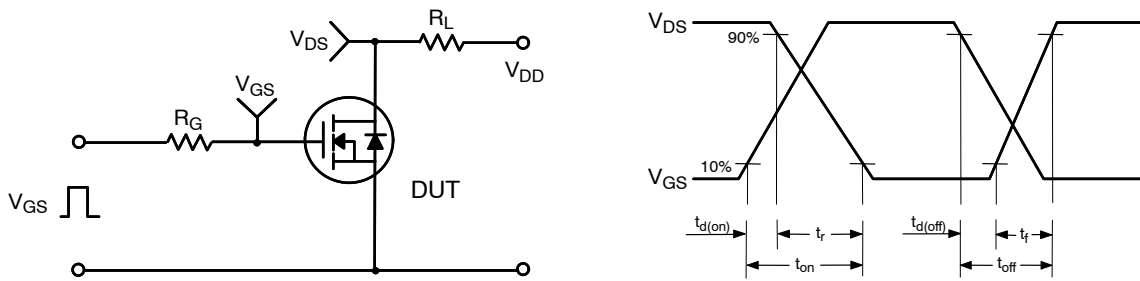

Figure 13. Resistive Switching Test Circuit & Waveforms

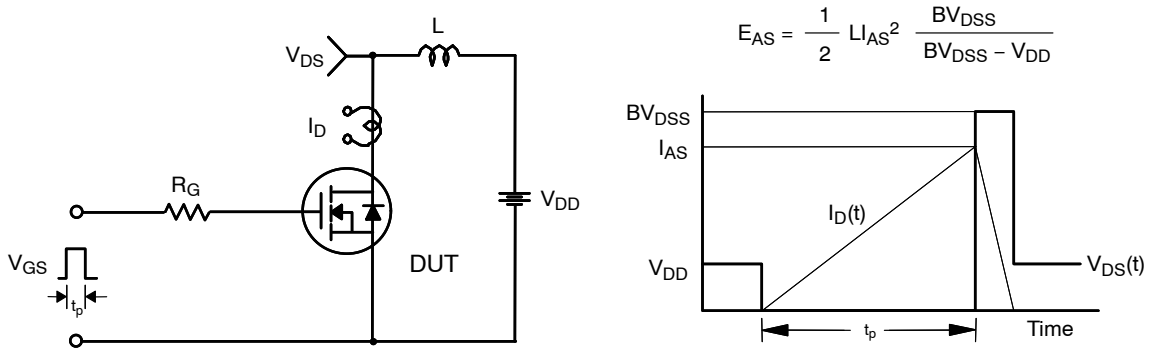
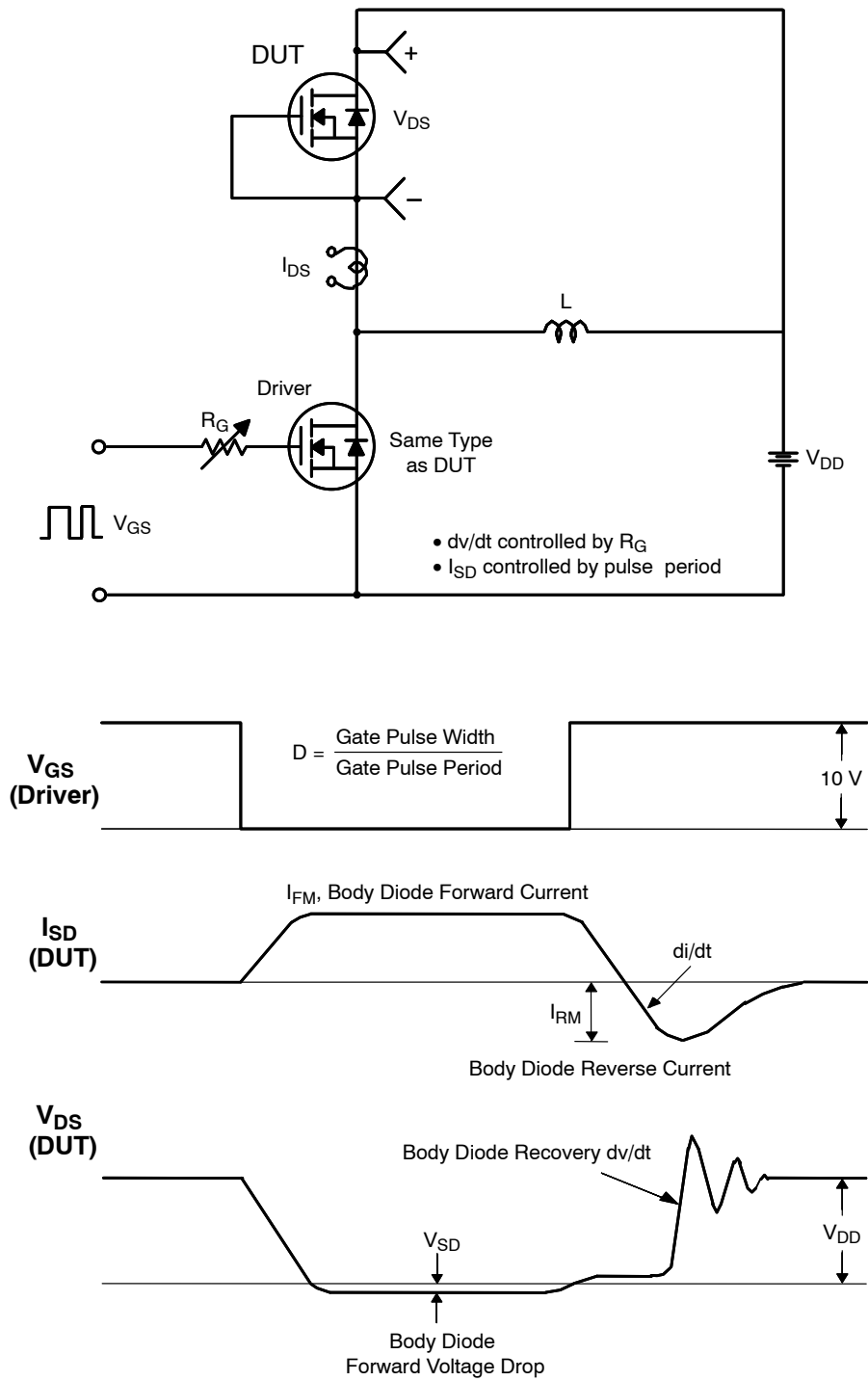

Figure 14. Unclamped Inductive Switching Test Circuit & Waveforms

# FQN1N60C

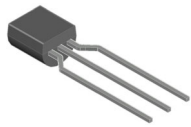

**Figure 15. Peak Diode Recovery  $dv/dt$  Test Circuit & Waveforms**

# MECHANICAL CASE OUTLINE

## PACKAGE DIMENSIONS

ON Semiconductor®



**TO-92 3LD 4.75x4.80**  
**CASE 135AV**  
**ISSUE O**

DATE 07 JAN 2021

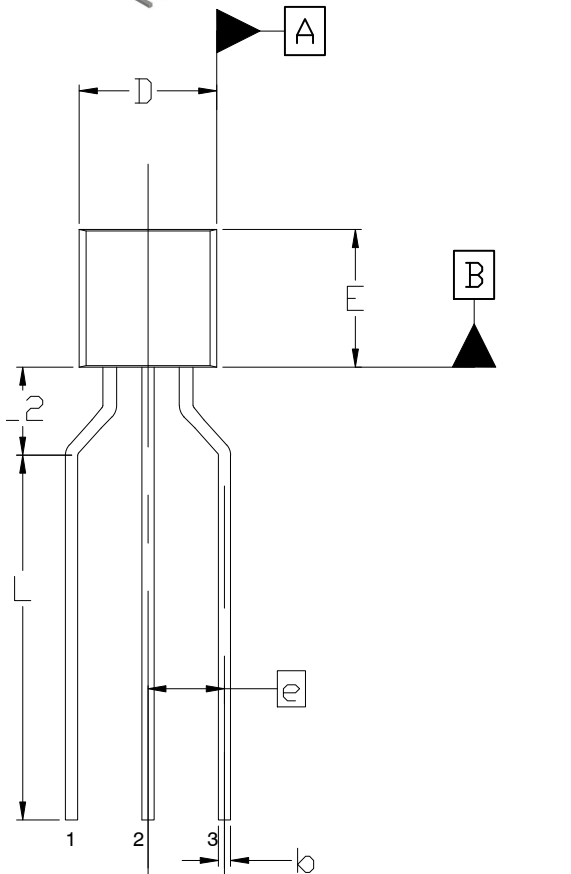

**NOTES:**

1. DIMENSIONING AND TOLERANCING PER ASME Y14.5M, 2009.
2. CONTROLLING DIMENSION: MILLIMETERS
3. DIMENSIONS ARE EXCLUSIVE OF BURRS, MOLD FLASH, GATE REMAINS AND TIE BAR PROTRUSIONS.

DIM	MILLIMETERS		
	MIN.	NOM.	MAX.
A	3.05	3.60	4.19
A1	2.13	2.50	2.88
b	0.36	0.46	0.56
c	0.30	0.40	0.52
D	4.32	4.75	5.20
E	4.32	4.80	5.33
e	2.54 BSC		
L	10.50	11.75	13.00
L2	2.54	---	3.44



TOP VIEW

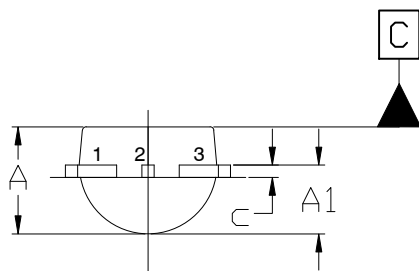

END VIEW

**GENERIC MARKING DIAGRAM\***

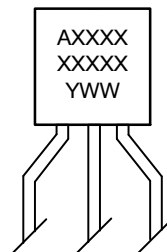

XXXX = Specific Device Code  
 A = Assembly Location  
 Y = Year  
 WW = Work Week

\*This information is generic. Please refer to device data sheet for actual part marking. Pb-Free indicator, "G" or microdot "•", may or may not be present. Some products may not follow the Generic Marking.

<b>DOCUMENT NUMBER:</b>	<b>98AON29250H</b>	Electronic versions are uncontrolled except when accessed directly from the Document Repository. Printed versions are uncontrolled except when stamped "CONTROLLED COPY" in red.
<b>DESCRIPTION:</b>	<b>TO-92 3LD 4.75X4.80</b>	<b>PAGE 1 OF 1</b>

ON Semiconductor and are trademarks of Semiconductor Components Industries, LLC dba ON Semiconductor or its subsidiaries in the United States and/or other countries. ON Semiconductor reserves the right to make changes without further notice to any products herein. ON Semiconductor makes no warranty, representation or guarantee regarding the suitability of its products for any particular purpose, nor does ON Semiconductor assume any liability arising out of the application or use of any product or circuit, and specifically disclaims any and all liability, including without limitation special, consequential or incidental damages. ON Semiconductor does not convey any license under its patent rights nor the rights of others.

**onsemi**, **Onsemi**, and other names, marks, and brands are registered and/or common law trademarks of Semiconductor Components Industries, LLC dba "**onsemi**" or its affiliates and/or subsidiaries in the United States and/or other countries. **onsemi** owns the rights to a number of patents, trademarks, copyrights, trade secrets, and other intellectual property. A listing of **onsemi**'s product/patent coverage may be accessed at [www.onsemi.com/site/pdf/Patent-Marking.pdf](http://www.onsemi.com/site/pdf/Patent-Marking.pdf). **onsemi** reserves the right to make changes at any time to any products or information herein, without notice. The information herein is provided "as-is" and **onsemi** makes no warranty, representation or guarantee regarding the accuracy of the information, product features, availability, functionality, or suitability of its products for any particular purpose, nor does **onsemi** assume any liability arising out of the application or use of any product or circuit, and specifically disclaims any and all liability, including without limitation special, consequential or incidental damages. Buyer is responsible for its products and applications using **onsemi** products, including compliance with all laws, regulations and safety requirements or standards, regardless of any support or applications information provided by **onsemi**. "Typical" parameters which may be provided in **onsemi** data sheets and/or specifications can and do vary in different applications and actual performance may vary over time. All operating parameters, including "Typicals" must be validated for each customer application by customer's technical experts. **onsemi** does not convey any license under any of its intellectual property rights nor the rights of others. **onsemi** products are not designed, intended, or authorized for use as a critical component in life support systems or any FDA Class 3 medical devices or medical devices with a same or similar classification in a foreign jurisdiction or any devices intended for implantation in the human body. Should Buyer purchase or use **onsemi** products for any such unintended or unauthorized application, Buyer shall indemnify and hold **onsemi** and its officers, employees, subsidiaries, affiliates, and distributors harmless against all claims, costs, damages, and expenses, and reasonable attorney fees arising out of, directly or indirectly, any claim of personal injury or death associated with such unintended or unauthorized use, even if such claim alleges that **onsemi** was negligent regarding the design or manufacture of the part. **onsemi** is an Equal Opportunity/Affirmative Action Employer. This literature is subject to all applicable copyright laws and is not for resale in any manner.

## ADDITIONAL INFORMATION

### TECHNICAL PUBLICATIONS:

Technical Library: [www.onsemi.com/design/resources/technical-documentation](http://www.onsemi.com/design/resources/technical-documentation)  
onsemi Website: [www.onsemi.com](http://www.onsemi.com)

### ONLINE SUPPORT: [www.onsemi.com/support](http://www.onsemi.com/support)

For additional information, please contact your local Sales Representative at [www.onsemi.com/support/sales](http://www.onsemi.com/support/sales)

