

# N-Channel RF Amplifier

## J211, MMBFJ211

### Description

This device is designed for HF/VHF mixer/amplifier and applications where process 50 is not adequate. Sufficient gain and low-noise for sensitive receivers. Sourced from process 90.

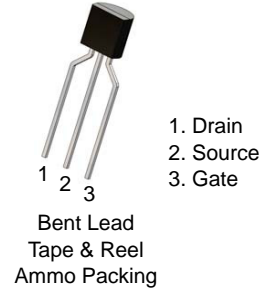

TO-92 3  
CASE 135AR

### MAXIMUM RATINGS (T<sub>A</sub> = 25°C unless otherwise noted) (Notes 1, 2)

Symbol	Parameter	Value	Unit
V <sub>DG</sub>	Drain–Gate Voltage	25	V
V <sub>GS</sub>	Gate–Source Voltage	–25	V
I <sub>GF</sub>	Forward Gate Current	10	mA
T <sub>J</sub> , T <sub>STG</sub>	Operating and Storage Junction Temperature Range	–55 to 150	°C

Stresses exceeding those listed in the Maximum Ratings table may damage the device. If any of these limits are exceeded, device functionality should not be assumed, damage may occur and reliability may be affected.

- These ratings are based on a maximum junction temperature of 150°C.
- These are steady-state limits. onsemi should be consulted on applications involving pulsed or low-duty-cycle operations.

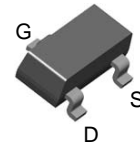

NOTE: Source & Drain are interchangeable

SOT-23  
CASE 318-08

### THERMAL CHARACTERISTICS (T<sub>A</sub> = 25°C unless otherwise noted)

Symbol	Parameter	Max		Unit
		J211 (Note 3)	MMBFJ211 (Note 3)	
P <sub>D</sub>	Total Device Dissipation	350	225	mW
	Derate Above 25°C	2.8	1.8	mW/°C
R <sub>θJC</sub>	Thermal Resistance, Junction–to–Case	125	–	°C/W
R <sub>θJA</sub>	Thermal Resistance, Junction–to–Ambient	357	556	°C/W

- Device mounted on FR-4 PCB 36 mm x 18 mm x 1.5 mm; mounting pad for the collector lead minimum 6 cm<sup>2</sup>.

### MARKING DIAGRAM

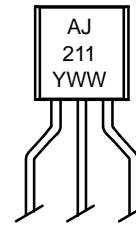

J211-D74Z

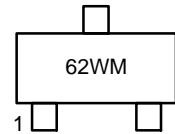

MMBFJ211

J211, 62W = Device Code  
A = Assembly Site  
WW = Work Week Number  
Y = Year of Production  
M = Date Code

### ORDERING INFORMATION

See detailed ordering and shipping information on page 5 of this data sheet.

# J211, MMBFJ211

## ELECTRICAL CHARACTERISTICS ( $T_A = 25^\circ\text{C}$ unless otherwise noted)

Symbol	Parameter	Conditions	Min	Max	Unit
--------	-----------	------------	-----	-----	------

### OFF CHARACTERISTICS

$V_{(BR)GSS}$	Gate-Source Breakdown Voltage	$I_G = 1.0 \mu\text{A}, V_{DS} = 0$	-25	-	V
$I_{GSS}$	Gate Reverse Current	$V_{GS} = 15 \text{ V}, V_{DS} = 0$	-	-100	pA
$V_{GS(off)}$	Gate-Source Cut-Off Voltage	$V_{DS} = 15 \text{ V}, I_D = 1.0 \text{ nA}$	-2.5	-4.5	V

### ON CHARACTERISTICS

$I_{DSS}$	Zero-Gate Voltage Drain Current (Note 4)	$V_{DS} = 15 \text{ V}, V_{GS} = 0$	7.0	20	mA
-----------	------------------------------------------	-------------------------------------	-----	----	----

### SMALL SIGNAL CHARACTERISTICS

$g_{fs}$	Common Source Forward Transconductance	$V_{DS} = 15 \text{ V}, V_{GS} = 0, f = 1.0 \text{ kHz}$	7000	12000	$\mu\text{mhos}$
$g_{oss}$	Common Source Output Conductance	$V_{DS} = 15 \text{ V}, V_{GS} = 0, f = 1.0 \text{ kHz}$	-	200	$\mu\text{mhos}$

Product parametric performance is indicated in the Electrical Characteristics for the listed test conditions, unless otherwise noted. Product performance may not be indicated by the Electrical Characteristics if operated under different conditions.

4. Pulse test: pulse width  $\leq 300 \mu\text{s}$

## TYPICAL PERFORMANCE CHARACTERISTICS

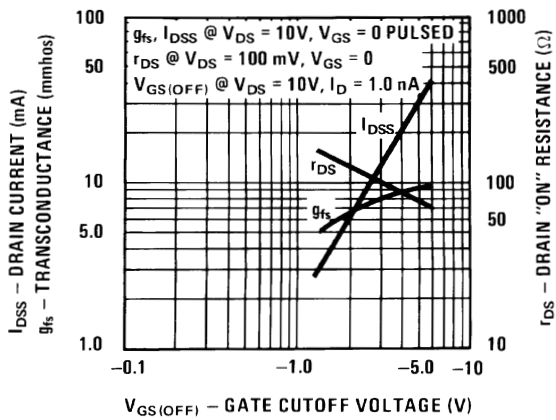

Figure 1. Parameter Interactions

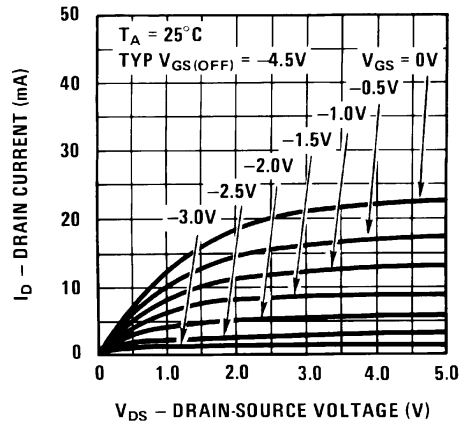

Figure 2. Common Drain-Source

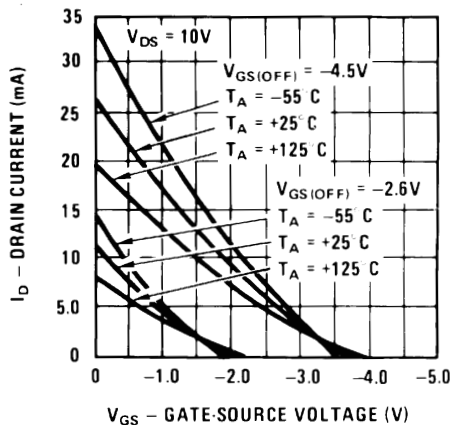

Figure 3. Transfer Characteristics

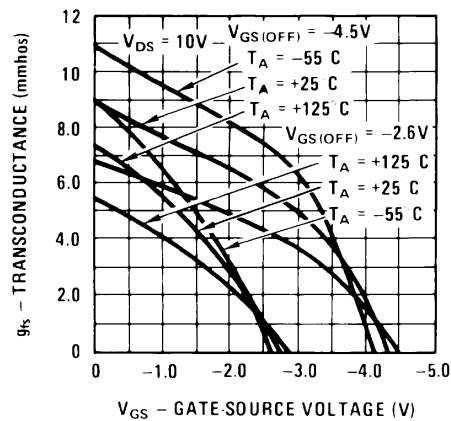

Figure 4. Transfer Characteristics

TYPICAL PERFORMANCE CHARACTERISTICS (continued)

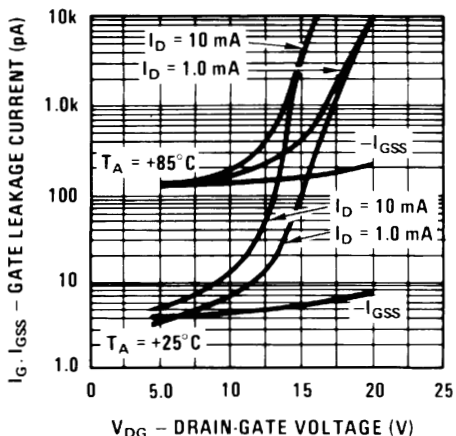

Figure 5. Leakage Current vs. Voltage

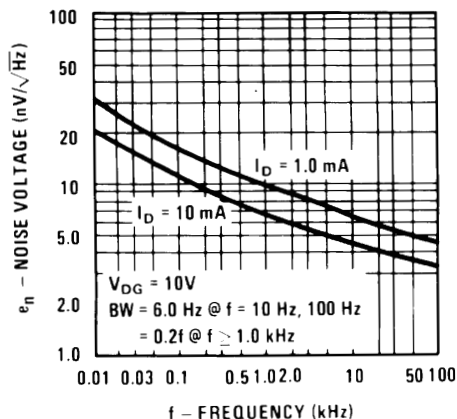

Figure 6. Noise Voltage vs. Frequency

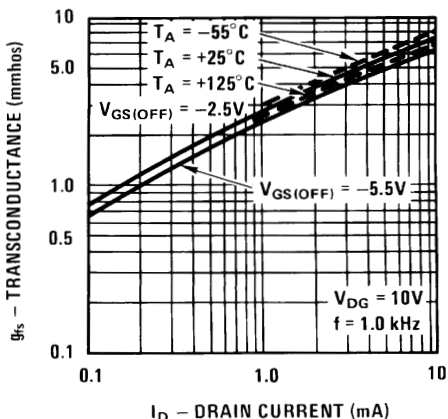

Figure 7. Transconductance vs. Drain Current

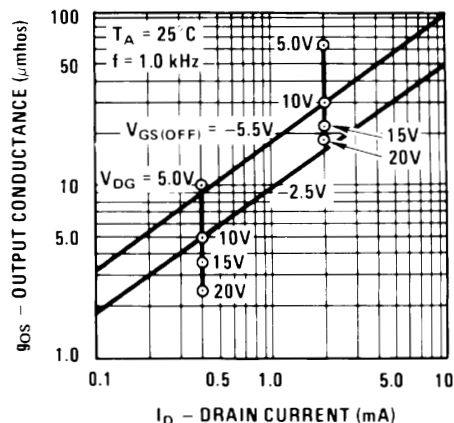

Figure 8. Output Conductance vs. Drain Current

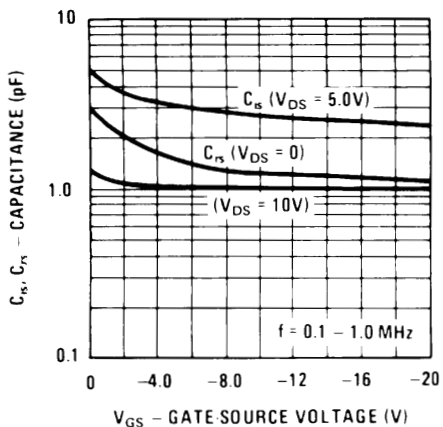

Figure 9. Capacitance vs. Voltage

# J211, MMBFJ211

## COMMON SOURCE CHARACTERISTICS

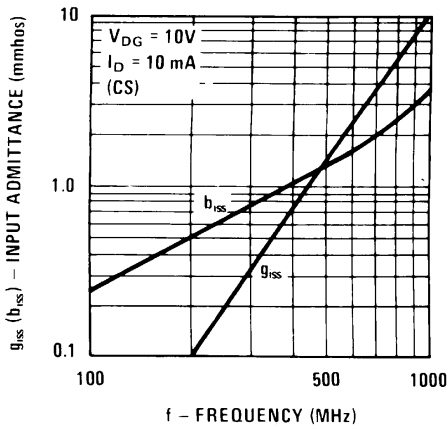

Figure 10. Input Admittance

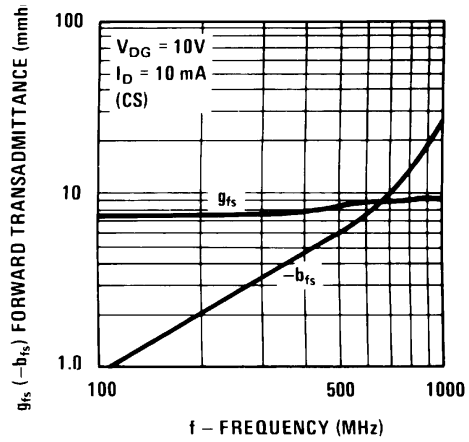

Figure 11. Forward Transadmittance

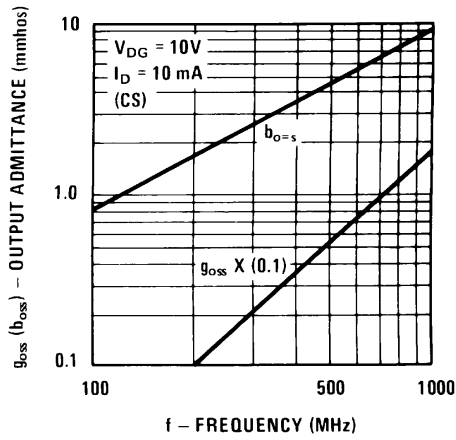

Figure 12. Output Admittance

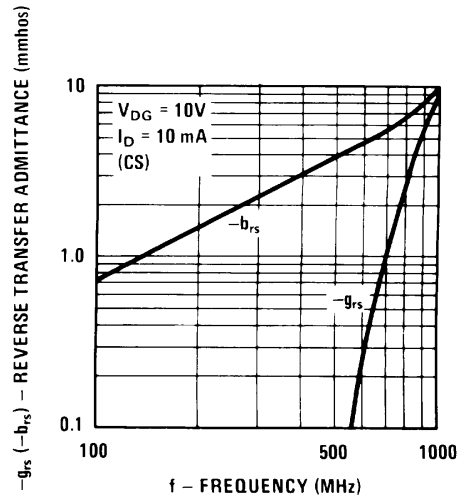

Figure 13. Reverse Transadmittance

# J211, MMBFJ211

## COMMON GATE CHARACTERISTICS

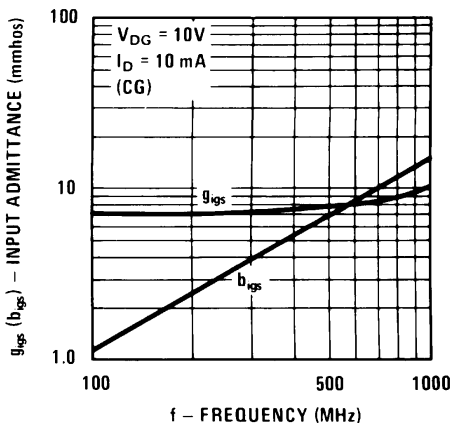

Figure 14. Input Admittance

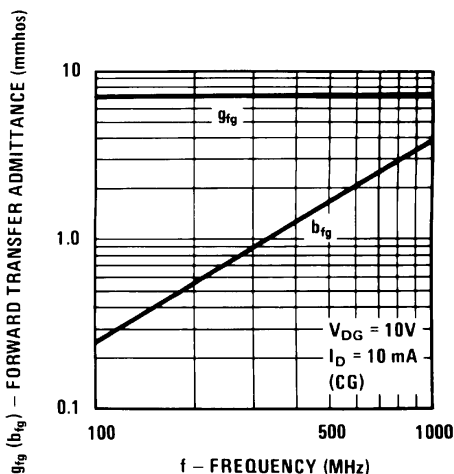

Figure 15. Forward Transadmittance

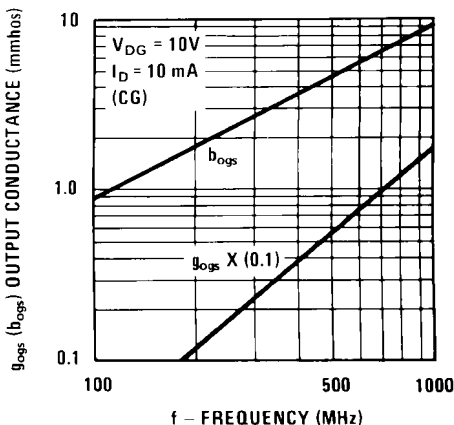

Figure 16. Output Admittance

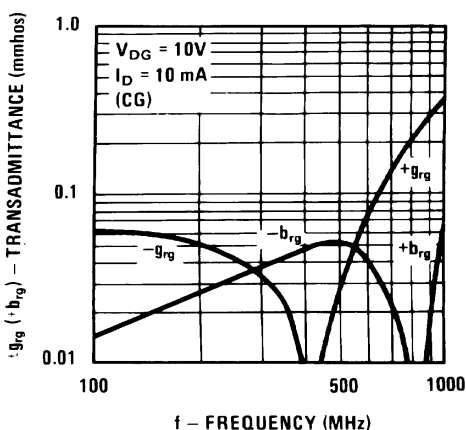

Figure 17. Reverse Transadmittance

### ORDERING INFORMATION

Part Number	Top Mark	Package	Packing Method†
J211-D74Z	J211	TO-92 3L (Pb-Free)	Ammo
MMBFJ211	62W	SOT-23 3L (Pb-Free)	Tape and Reel

†For information on tape and reel specifications, including part orientation and tape sizes, please refer to our Tape and Reel Packaging Specifications Brochure, BRD8011/D.

**TO-92 3 4.83x4.76 LEADFORMED**  
**CASE 135AR**  
**ISSUE O**

DATE 30 SEP 2016

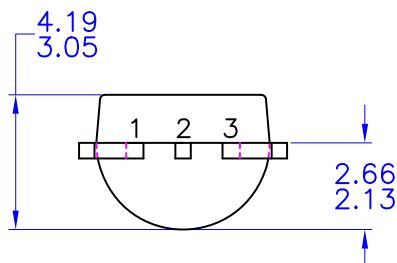
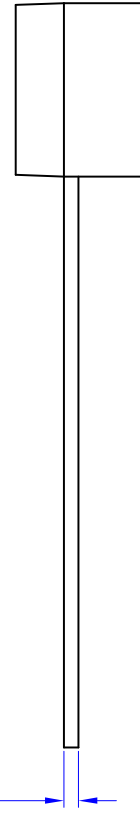
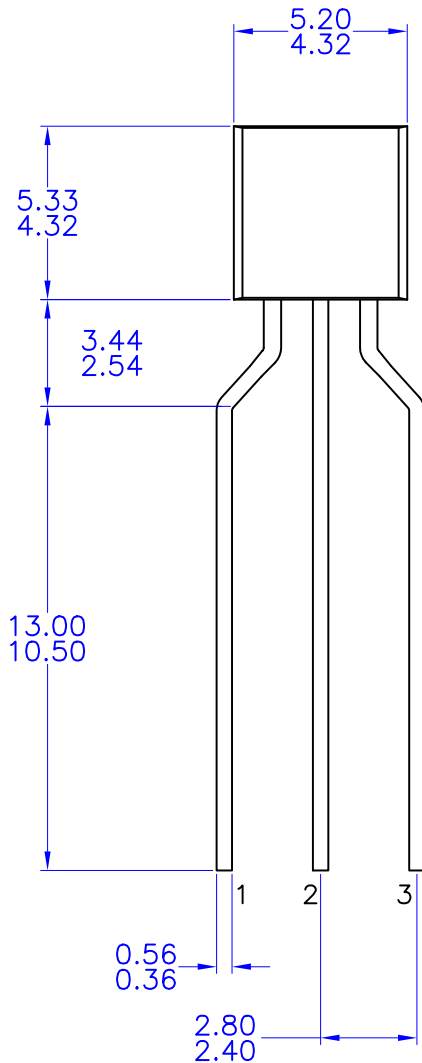

NOTES: UNLESS OTHERWISE SPECIFIED

- A) DRAWING WITH REFERENCE TO JEDEC TO-92 RECOMMENDATIONS.
- B) ALL DIMENSIONS ARE IN MILLIMETERS.
- C) DRAWING CONFORMS TO ASME Y14.5M-1994

<b>DOCUMENT NUMBER:</b>	<b>98AON13879G</b>	Electronic versions are uncontrolled except when accessed directly from the Document Repository. Printed versions are uncontrolled except when stamped "CONTROLLED COPY" in red.
<b>DESCRIPTION:</b>	<b>TO-92 3 4.83X4.76 LEADFORMED</b>	<b>PAGE 1 OF 1</b>

ON Semiconductor and  are trademarks of Semiconductor Components Industries, LLC dba ON Semiconductor or its subsidiaries in the United States and/or other countries. ON Semiconductor reserves the right to make changes without further notice to any products herein. ON Semiconductor makes no warranty, representation or guarantee regarding the suitability of its products for any particular purpose, nor does ON Semiconductor assume any liability arising out of the application or use of any product or circuit, and specifically disclaims any and all liability, including without limitation special, consequential or incidental damages. ON Semiconductor does not convey any license under its patent rights nor the rights of others.

**onsemi**, **Onsemi**, and other names, marks, and brands are registered and/or common law trademarks of Semiconductor Components Industries, LLC dba "**onsemi**" or its affiliates and/or subsidiaries in the United States and/or other countries. **onsemi** owns the rights to a number of patents, trademarks, copyrights, trade secrets, and other intellectual property. A listing of **onsemi**'s product/patent coverage may be accessed at [www.onsemi.com/site/pdf/Patent-Marking.pdf](http://www.onsemi.com/site/pdf/Patent-Marking.pdf). **onsemi** reserves the right to make changes at any time to any products or information herein, without notice. The information herein is provided "as-is" and **onsemi** makes no warranty, representation or guarantee regarding the accuracy of the information, product features, availability, functionality, or suitability of its products for any particular purpose, nor does **onsemi** assume any liability arising out of the application or use of any product or circuit, and specifically disclaims any and all liability, including without limitation special, consequential or incidental damages. Buyer is responsible for its products and applications using **onsemi** products, including compliance with all laws, regulations and safety requirements or standards, regardless of any support or applications information provided by **onsemi**. "Typical" parameters which may be provided in **onsemi** data sheets and/or specifications can and do vary in different applications and actual performance may vary over time. All operating parameters, including "Typicals" must be validated for each customer application by customer's technical experts. **onsemi** does not convey any license under any of its intellectual property rights nor the rights of others. **onsemi** products are not designed, intended, or authorized for use as a critical component in life support systems or any FDA Class 3 medical devices or medical devices with a same or similar classification in a foreign jurisdiction or any devices intended for implantation in the human body. Should Buyer purchase or use **onsemi** products for any such unintended or unauthorized application, Buyer shall indemnify and hold **onsemi** and its officers, employees, subsidiaries, affiliates, and distributors harmless against all claims, costs, damages, and expenses, and reasonable attorney fees arising out of, directly or indirectly, any claim of personal injury or death associated with such unintended or unauthorized use, even if such claim alleges that **onsemi** was negligent regarding the design or manufacture of the part. **onsemi** is an Equal Opportunity/Affirmative Action Employer. This literature is subject to all applicable copyright laws and is not for resale in any manner.

## ADDITIONAL INFORMATION

### TECHNICAL PUBLICATIONS:

Technical Library: [www.onsemi.com/design/resources/technical-documentation](http://www.onsemi.com/design/resources/technical-documentation)  
onsemi Website: [www.onsemi.com](http://www.onsemi.com)

### ONLINE SUPPORT: [www.onsemi.com/support](http://www.onsemi.com/support)

For additional information, please contact your local Sales Representative at [www.onsemi.com/support/sales](http://www.onsemi.com/support/sales)