

3.3 V USB 3.1 Quad Channel / Dual Port Linear Redriver

NB7NPQ7042M

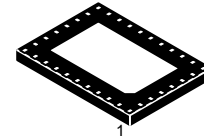

X2QFN34
CASE 722AL

Description

The NB7NPQ7042M is a 3.3 V quad channel / dual port linear redriver suitable for USB 3.1 Gen 1 and USB 3.1 Gen 2 applications that supports both 5 Gbps and 10 Gbps data rates. Signal integrity degrades from PCB traces, transmission cables, and inter-symbol interference (ISI). The NB7NPQ7042M compensates for these losses by engaging varying levels of equalization at the input receiver, and flat gain amplification on the output transmitter. The Flat Gain and Equalization are controlled by four level control pins. Each channel has a set of independent control pins to make signal optimization possible.

After power up, the NB7NPQ7042M periodically checks both of the TX output pairs of each port for a receiver connection. When the receiver is detected on both channels, the RX termination becomes enabled of that respective port and is set to perform the redriver function.

The port becomes active once both TX outputs have detected 50-ohm termination, and the NB7NPQ7042M is set to perform the redriver function. Port AB (channels A & B) and port CD (channels C & D) are independent of each other.

The NB7NPQ7042M comes in a small 3.1 x 4.3 mm X2QFN34 package and is specified to operate across the entire industrial temperature range, -40°C to 85°C.

Features

- 3.3 V ± 5% Power Supply
- Supports USB 3.1 Gen 1 and USB 3.1 Gen 2 Data Rates
- Automatic Receiver Termination Detection
- Integrated Input and Output Termination
- Independent, Selectable Equalization and Flat Gain
- Hot-Plug Capable
- Flow-through Design for Ease of PCB Layout
- ESD Protection: 2 kV HBM
- Operating Temperature Range: -40°C to 85°C
- Small 3.1 x 4.3 x 0.35 mm X2QFN34 Package
- This is a Pb-Free Device

Typical Applications

- USB3.1 Type-C and Type-A Signal Routing
- Mobile Phone and Tablet
- Computer and Laptop
- Docking Station and Dongle
- Active Cable, Back Planes
- Gaming Console, Smart T.V., Set-Top Boxes

MARKING DIAGRAM

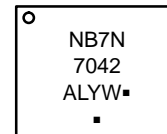

NB7N7042 = Specific Device Code

A = Assembly Location

L = Wafer Lot

Y = Year

W = Work Week

▪ = Pb-Free Package

(Note: Microdot may be in either location)

ORDERING INFORMATION

Device	Package	Shipping†
NB7NPQ7042MMUTWG	X2QFN34 (Pb-Free)	3000 / Tape & Reel

†For information on tape and reel specifications, including part orientation and tape sizes, please refer to our Tape and Reel Packaging Specifications Brochure, BRD8011/D.

NB7NPQ7042M

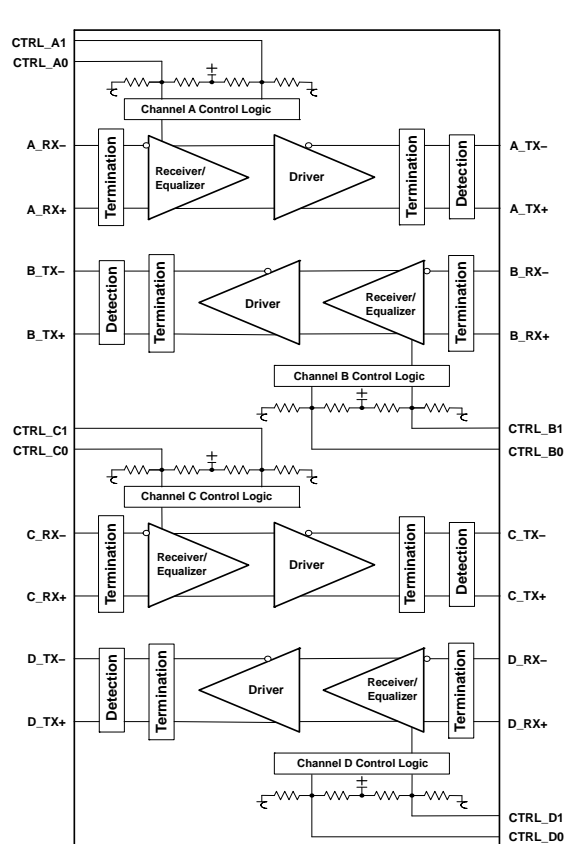

Figure 1. Logic Diagram

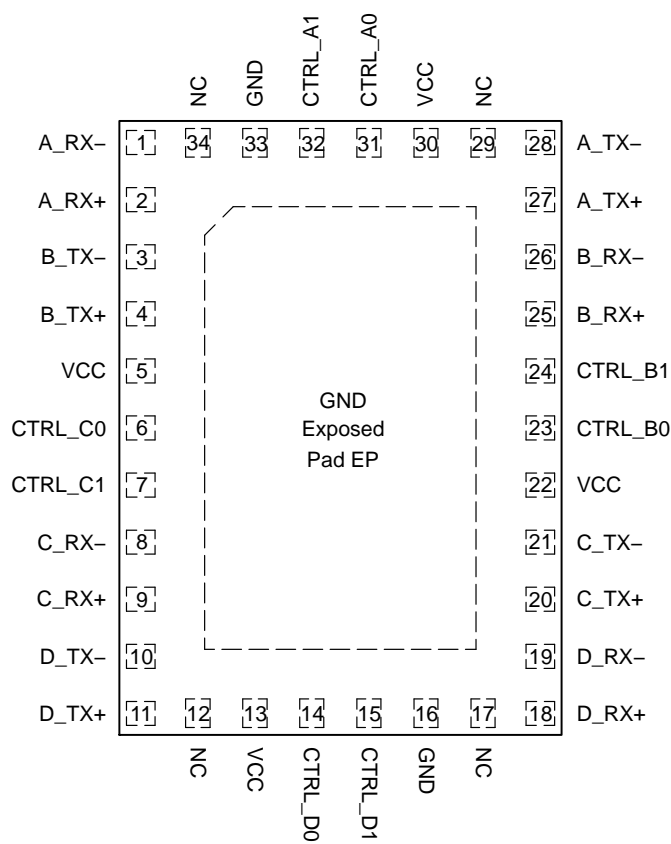

Figure 2. X2QFN34 Package Pinout (Top View)

Table 1. PIN DESCRIPTION

Pin Number	Pin Name	Type	Description
1	A_RX-	DIFF INPUT	Channel A Differential input for 5 / 10 Gbps USB signals. Must be externally AC-coupled.
2	A_RX+		
3	B_TX-	DIFF OUTPUT	Channel B Differential output for 5 / 10 Gbps USB signals. Must be externally AC-coupled.
4	B_TX+		
5, 13, 22, 30	VCC	POWER	3.3V power supply. V _{CC} pins must be externally connected to power supply to guarantee proper operation.
6	CTRL_C0	LVC MOS INPUT	Pin C0 for control of Flat Gain settings on Channel C having internal 100 kΩ pull up and 200 kΩ pull down. 4 state input: HIGH "H" where pin is connected to V _{CC} , LOW "L" where pin is connected to Ground, FLOAT "F" where the pin is left floating (open) and Rext "R" where an external resistor 68 kΩ connected from pin to Ground. Refer Table 2 for the different settings.
7	CTRL_C1	LVC MOS INPUT	Pin C1 for control of Equalization settings on Channel C having internal 100 kΩ pull up and 200 kΩ pull down. 4 state input: HIGH "H" where pin is connected to V _{CC} , LOW "L" where pin is connected to Ground, FLOAT "F" where the pin is left floating (open) and Rext "R" where an external resistor 68 kΩ connected from pin to Ground. Refer Table 2 for the different settings.
8	C_RX-	DIFF INPUT	Channel C Differential input for 5 / 10 Gbps USB signals. Must be externally AC-coupled.
9	C_RX+		
10	D_TX-	DIFF OUTPUT	Channel D Differential output for 5 / 10 Gbps USB signals. Must be externally AC-coupled.
11	D_TX+		
12, 17, 29, 34	NC		No connection, must be left Open/Float

NB7NPQ7042M

Table 1. PIN DESCRIPTION

Pin Number	Pin Name	Type	Description
14	CTRL_D0	LVC MOS INPUT	Pin D0 for control of Equalization settings on Channel D having internal 100 kΩ pull up and 200 kΩ pull down. 4 state input: HIGH "H" where pin is connected to V _{CC} , LOW "L" where pin is connected to Ground, FLOAT "F" where the pin is left floating (open) and Rext "R" where an external resistor 68 kΩ connected from pin to Ground. Refer Table 2 for the different settings.
15	CTRL_D1	LVC MOS INPUT	Pin D1 for control of Flat Gain settings on Channel D having internal 100 kΩ pull up and 200 kΩ pull down. 4 state input: HIGH "H" where pin is connected to V _{CC} , LOW "L" where pin is connected to Ground, FLOAT "F" where the pin is left floating (open) and Rext "R" where an external resistor 68 kΩ connected from pin to Ground. Refer Table 2 for the different settings.
16, 33	GND	GROUND	Reference Ground. GND pins must be externally connected to ground to guarantee proper operation.
18	D_RX+	DIFF INPUT	Channel D Differential input for 5 / 10 Gbps USB signals. Must be externally AC-coupled.
19	D_RX-		
20	C_TX+	DIFF OUTPUT	Channel C Differential output for 5 / 10 Gbps USB signals. Must be externally AC-coupled.
21	C_TX-		
23	CTRL_B0	LVC MOS INPUT	Pin B0 for control of Flat Gain settings on Channel B having internal 100 kΩ pull up and 200 kΩ pull down. 4 state input: HIGH "H" where pin is connected to V _{CC} , LOW "L" where pin is connected to Ground, FLOAT "F" where the pin is left floating (open) and Rext "R" where an external resistor 68 kΩ connected from pin to Ground. Refer Table 2 for the different settings.
24	CTRL_B1	LVC MOS INPUT	Pin B1 for control of Equalization settings on Channel B having internal 100 kΩ pull up and 200 kΩ pull down. 4 state input: HIGH "H" where pin is connected to V _{CC} , LOW "L" where pin is connected to Ground, FLOAT "F" where the pin is left floating (open) and Rext "R" where an external resistor 68 kΩ connected from pin to Ground. Refer Table 2 for the different settings.
25	B_RX+	DIFF INPUT	Channel B Differential input for 5 / 10 Gbps USB signals. Must be externally AC-coupled.
26	B_RX-		
27	A_TX+	DIFF OUTPUT	Channel A Differential output for 5 / 10 Gbps USB signals. Must be externally AC-coupled.
28	A_TX-		
31	CTRL_A0	LVC MOS INPUT	Pin A0 for control of Equalization settings on Channel A having internal 100 kΩ pull up and 200 kΩ pull down. 4 state input: HIGH "H" where pin is connected to V _{CC} , LOW "L" where pin is connected to Ground, FLOAT "F" where the pin is left floating (open) and Rext "R" where an external resistor 68 kΩ connected from pin to Ground. Refer Table 2 for the different settings.
32	CTRL_A1	LVC MOS INPUT	Pin A1 for control of Flat Gain settings on Channel A having internal 100 kΩ pull up and 200 kΩ pull down. 4 state input: HIGH "H" where pin is connected to V _{CC} , LOW "L" where pin is connected to Ground, FLOAT "F" where the pin is left floating (open) and Rext "R" where an external resistor 68 kΩ connected from pin to Ground. Refer Table 2 for the different settings.
EP	GND	GROUND	Exposed pad (EP). EP on the package bottom is thermally connected to the die for improved heat transfer out of the package. The pad is not electrically connected to the die, but is recommended to be soldered to GND on the PC Board.

NB7NPQ7042M

DEVICE CONFIGURATION

Table 2. CONTROL PIN EFFECTS (Typical Values)

Settings	PORT A/B				PORT C/D				EQ (dB)	FG (dB)
	Channel A		Channel B		Channel C		Channel D			
	CTRL_A1 (FGA)	CTRL_A0 (EQA)	CTRL_B1 (EQB)	CTRL_B0 (FGB)	CTRL_C1 (EQC)	CTRL_C0 (FGC)	CTRL_D1 (FGD)	CTRL_D0 (EQD)		
1	L	L	L	L	L	L	L	L	10.9	-3
2	L	R	R	L	R	L	L	R	6.7	-3
3	L	F	F	L	F	L	L	F	8.9	-3
4	L	H	H	L	H	L	L	H	13.1	-3
5	R	L	L	R	L	R	R	L	10.9	-1.5
6	R	R	R	R	R	R	R	R	6.7	-1.5
7	R	F	F	R	F	R	R	F	8.9	-1.5
8	R	H	H	R	H	R	R	H	13.1	-1.5
9	F	L	L	F	L	F	F	L	10.9	0
10	F	R	R	F	R	F	F	R	6.7	0
11 (Default)	F	F	F	F	F	F	F	F	8.9	0
12	F	H	H	F	H	F	F	H	13.1	0
13	H	L	L	H	L	H	H	L	10.9	2
14	H	R	R	H	R	H	H	R	6.7	2
15	H	F	F	H	F	H	H	F	8.9	2
16	H	H	H	H	H	H	H	H	13.1	2

NOTE: EQ and FG can be set by adjusting the voltage to the control pins. There are 4 specific levels – HIGH “H” where pin is connected to V_{CC}, LOW “L” where pin is connected to Ground, FLOAT “F” where the pin is left floating (open) and Rext “R” where an external resistor 68 kΩ connected from pin to Ground. Please refer Table 7 for voltage levels.

Table 3. ATTRIBUTES

Parameter	
ESD Protection	Human Body Model Charged Device Model ≤ 2 kV ≤ 1.5 kV
Moisture Sensitivity, Indefinite Time Out of Dry pack (Note 1)	Level 1
Flammability Rating	Oxygen Index: 28 to 34 UL 94 V-O @ 0.125 in
Transistor Count	81,034
Meets or exceeds JEDEC Spec EIA/JESD78 IC Latch-up Test	

1. For additional information, see Application Note AND8003/D.

Table 4. ABSOLUTE MAXIMUM RATINGS Over operating free-air temperature range (unless otherwise noted)

Parameter	Description	Min	Max	Unit
Supply Voltage (Note 2)	V _{CC}	-0.5	4.6	V
Voltage range at any input or output terminal	Differential I/O	-0.5	V _{CC} + 0.5	V
	LVC MOS inputs	-0.5	V _{CC} + 0.5	V
Storage Temperature Range, T _{SG}		-65	150	°C
Maximum Junction Temperature, T _J			125	°C
Operating Ambient Temperature Range, T _A		-40	85	°C
Junction-to-Ambient Thermal Resistance @ 500 lfm, θ _{JA} (Note 3)			34	°C/W
Wave Solder, Pb-Free, T _{SOL}			265	°C

Stresses exceeding those listed in the Maximum Ratings table may damage the device. If any of these limits are exceeded, device functionality should not be assumed, damage may occur and reliability may be affected.

2. All voltage values are with respect to the GND terminals.

3. JEDEC standard multilayer board – 2S2P (2 signal, 2 power).

NB7NPQ7042M

Table 5. RECOMMENDED OPERATING CONDITIONS Over operating free-air temperature range (unless otherwise noted)

Parameter	Description	Min	Nom	Max	Unit
V _{CC}	Main power supply	3.135	3.3	3.465	V
T _A	Operating free-air temperature	-40		+85	°C
C _{AC}	AC coupling capacitor	75	100	265	nF
R _{ext}	External Resistor for input setting "R" ± 5%		68		kΩ

Functional operation above the stresses listed in the Recommended Operating Ranges is not implied. Extended exposure to stresses beyond the Recommended Operating Ranges limits may affect device reliability.

Table 6. POWER SUPPLY CHARACTERISTICS

Parameter		Test Conditions	Min	Typ (Note 4)	Max	Unit
I _{CC}	Active	Link in U0 with Super Speed Plus data transmission		225		mA
	U2/U3	Link in U2 or U3 power saving state		0.8		mA
	No USB Connection	No connection state, termination disabled		0.5		mA

4. TYP values use V_{CC} = 3.3 V, T_A = 25°C

Table 7. LVCMOS CONTROL PIN CHARACTERISTICS

4-State LVCMOS Inputs (CTRL_A0, CTRL_A1, CTRL_B0, CTRL_B1, CTRL_C0, CTRL_C1, CTRL_D0, CTRL_D1)

Parameter		Test Conditions	Min	Typ	Max	Unit
V _{IL}	DC Input Setting "L" LOW	Input pin connected to GND		GND	0.1*V _{CC}	V
V _{IR}	DC Input Setting "R" with R _{ext}	R _{ext} (typ 68 kΩ) must be connected between Pin and GND, [Logic 1/3 * V _{CC}]	0.23*V _{CC}	0.33*V _{CC}	0.43*V _{CC}	V
V _{IF}	DC Input Setting "F" FLOAT (Note 5)	Input pin is left FLOAT (open), [Logic 2/3 * V _{CC}]	0.56*V _{CC}	0.66*V _{CC}	0.76*V _{CC}	V
V _{IH}	DC Input Setting "H" HIGH	Input pin connected to V _{CC}		V _{CC}		V
R _{PU}	Internal pull-up resistance			100		kΩ
R _{PD}	Internal pull-down resistance			200		kΩ
I _{IH}	High-level input current	V _{IN} = 3.465 V, V _{CC} = 3.465 V			25	μA
I _{IL}	Low-level input current	V _{IN} = GND, V _{CC} = 3.465 V	-45			μA

5. Floating refers to a pin left in an open state, with no external connections.

Table 8. RECEIVER AC/DC CHARACTERISTICS Over operating free-air temperature range (unless otherwise noted)

Parameter		Test Conditions	Min	Typ	Max	Unit
V _{RX-DIFF-pp}	Input differential voltage swing	AC-coupled, peak-to-peak	100		1200	mV _{PP}
V _{RX-CM}	Common-mode voltage bias in the receiver (DC)			V _{CC}		V
Z _{RX-DIFF}	Differential input resistance (DC)	Present after an USB device is detected on TX+/TX-	80	100	120	Ω
Z _{RX-CM}	Common-mode input resistance (DC)	Present after an USB device is detected on TX+/TX-	20	25	30	Ω
Z _{RX-HIGH-IMP}	Common-mode input resistance with termination disabled (DC)	Present when no USB device is detected on TX+	25			kΩ
V _{TH-LFPS-pp}	Low Frequency Periodic Signaling (LFPS) Detect Threshold	Output voltage is considered squelched below this threshold voltage.	100	200	300	mV _{PP}

Product parametric performance is indicated in the Electrical Characteristics for the listed test conditions, unless otherwise noted. Product performance may not be indicated by the Electrical Characteristics if operated under different conditions.

NB7NPQ7042M

Table 9. TRANSMITTER AC/DC CHARACTERISTICS Over operating free-air temperature range (unless otherwise noted)

Parameter	Test Conditions	Min	Typ	Max	Unit	
V_{sw_100M}	-1 dB compression point Output swing at 100 MHz		900		mV _{PPd}	
V_{sw_5G}	-1 dB compression point Output swing at 5 GHz		900		mV _{PPd}	
C_{TX}	TX input capacitance to GND		1.25		pF	
$Z_{TX-DIFF}$	Differential output impedance (DC)	Present after an USB device is detected on TX+/TX-	80	100	120	Ω
Z_{TX-CM}	Common-mode output impedance (DC)	Present after an USB device is detected on TX+/TX-	20	25	30	Ω
I_{TX-SC}	TX short circuit current	TX+ or TX- shorted to GND		90		mA
V_{TX-CM}	Common-mode voltage bias in the transmitter (DC)	100 mV, 50 MHz, 5 Gbps and 10 Gbps, PRBS 2 ⁷		$V_{CC}-0.8$	V_{CC}	V
$V_{TX-CM-ACpp}$	AC common-mode peak-to-peak voltage swing in active mode	Within U0 and at 50 MHz (LFPS)			100	mV _{PP}
$V_{TX-IDLE-DIFF-ACpp}$	Differential voltage swing during electrical idle	Tested with a high-pass filter	0		10	mV _{PP}
$V_{TX-RXDET}$	Voltage change to allow receiver detect	The change in voltage that triggers detection of a receiver.		325	600	mV
t_R, t_F	Output rise, fall time	20% – 80% of differential voltage measured 1 inch from the output pin		35		ps
t_{RF-MM}	Output rise, Fall time mismatch	20% – 80% of differential voltage measured 1 inch from the output pin			5	ps
$t_{diff-LH}, t_{diff-HL}$	Differential propagation delay	Propagation delay between 50% level at input and output		90		ps
$t_{idleExit}$	Idle exit time	50 MHz clock signal, EQ an FG setting "11 (Default)" FF		5		ns
$t_{idleEntry}$	Idle entry time	50 MHz clock signal, EQ an FG setting "11 (Default)" FF		20		ns

Table 10. TIMING AND JITTER CHARACTERISTICS

Parameter	Test Conditions	Min	Typ	Max	Unit
-----------	-----------------	-----	-----	-----	------

TIMING

t_{READY}	Time from power applied until RX termination is enabled	Apply 0 V to V_{CC} , connect USB termination to TX±, apply 3.3 V to V_{CC} , and measure when $Z_{RX-DIFF}$ is enabled		100		ms
-------------	---	---	--	-----	--	----

JITTER FOR 5 Gbps

$T_{JTX-EYE}$	Total jitter (Notes 6, 7)	EQ and FG Setting "FF"		0.035		UI (Note 8)
D_{JTX}	Deterministic jitter (Note 7)			0.003		UI
R_{JTX}	Random jitter (Note 7)			0.005		UI

JITTER FOR 10 Gbps

$T_{JTX-EYE}$	Total jitter (Notes 6, 7)	EQ and FG Setting "FF"		0.085		UI (Note 8)
D_{JTX}	Deterministic jitter (Note 7)			0.04		UI
R_{JTX}	Random jitter (Note 7)			0.007		UI

6. Includes RJ at 10⁻¹².

7. Measured at the ends of reference channel with a K28.5 pattern, VID = 1000 mVpp, -3.5 dB de-emphasis from source.

8. 5 Gbps, UI = 200 ps for 10 Gbps, UI = 100 ps

PARAMETER MEASUREMENT DIAGRAMS

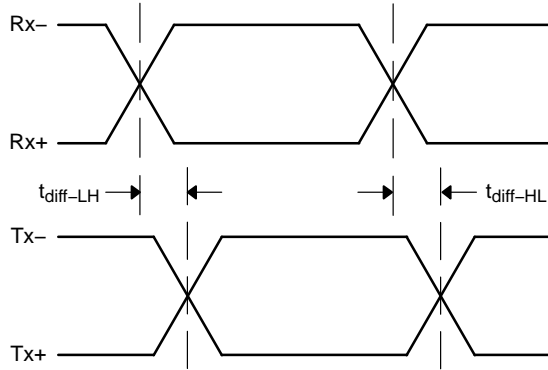

Figure 3. Propagation Delay

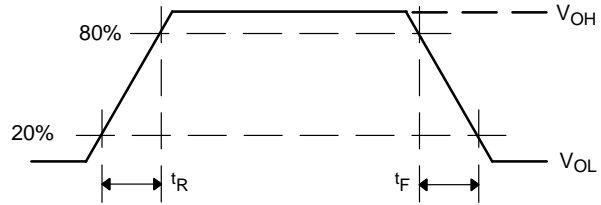

Figure 4. Output Rise and Fall Times

APPLICATION GUIDELINES

LFPS Compliance Testing

As part of USB 3.1 compliance test, the host or peripheral must transmit a LFPS signal that adheres to the spec parameters. The NB7NPQ7042M is tested as a part of a USB compliant system to ensure that it maintains compliance while increasing system performance.

LFPS Functionality

USB 3.1, Gen1 and Gen2 use Low Frequency Periodic Signaling.

(LFPS) to implement functions like exiting low-power modes, performing warm resets and providing link training between host and peripheral devices. LFPS signaling consists of bursts of frequencies ranging between 10 to 50 MHz and can have specific burst lengths or repeat rates.

Ping.LFPS for TX Compliance

During the transmitter compliance, the system under test must transmit certain compliance patterns as defined by the USB-IF. In order to toggle through these patterns for various tests, the receiver must receive a ping.LFPS signal from either the test suite or a separate pattern generator. The standard signal comprises of a single burst period of 100 ns at 20 MHz.

Control Pin Settings

Control pins CTRL_A1, CTRL_B0, CTRL_C0 & CTRL_D1 controls the flat gain and CTRL_A0, CTRL_B1, CTRL_C1 & CTRL_D0 controls the equalization of channels A, B, C and D respectively.

The Float (Default) Setting “F” can be set by leaving the control pins in a floating state. The redriver will internally

bias (with an internal pull up resistor of 100 kΩ and pull down resistor of 200 kΩ) the control pins to the correct voltage (Logic $2/3 * V_{CC}$). The low setting “L” can be set by pulling the control pin to ground. The high setting “H” can be set by pulling the pin high to V_{CC} . The Rext setting can be set by adding a 68 kΩ resistor from the control pin to ground. This will bias the redriver internal voltage to Logic $1/3 * V_{CC}$.

Linear Equalization

The linear equalization that the NB7NPQ7042M provides compensates for losses that occur naturally along board traces and cable lines. Linear Equalization boosts high frequencies and lower frequencies linearly so when transmitting at varying frequencies, the voltage amplitude will remain consistent. This compensation electrically counters losses and allows for longer traces to be possible when routing.

DC Flat Gain

DC flat gain equally boosts high and low frequency signals, and is essential for countering low frequency losses.

DC flat gain can also be used to simulate a higher input signal from a USB Controller. If a USB controller can only provide 800 mV differential to a receiver, it can be boosted to 1130 mV using 3 dB of flat gain.

Total Gain

When using Flat Gain with Equalization in a USB application it is important to make sure that the total voltage does not exceed 1200 mV. Total gain can be calculated by adding the EQ gain to the FG.

NB7NPQ7042M

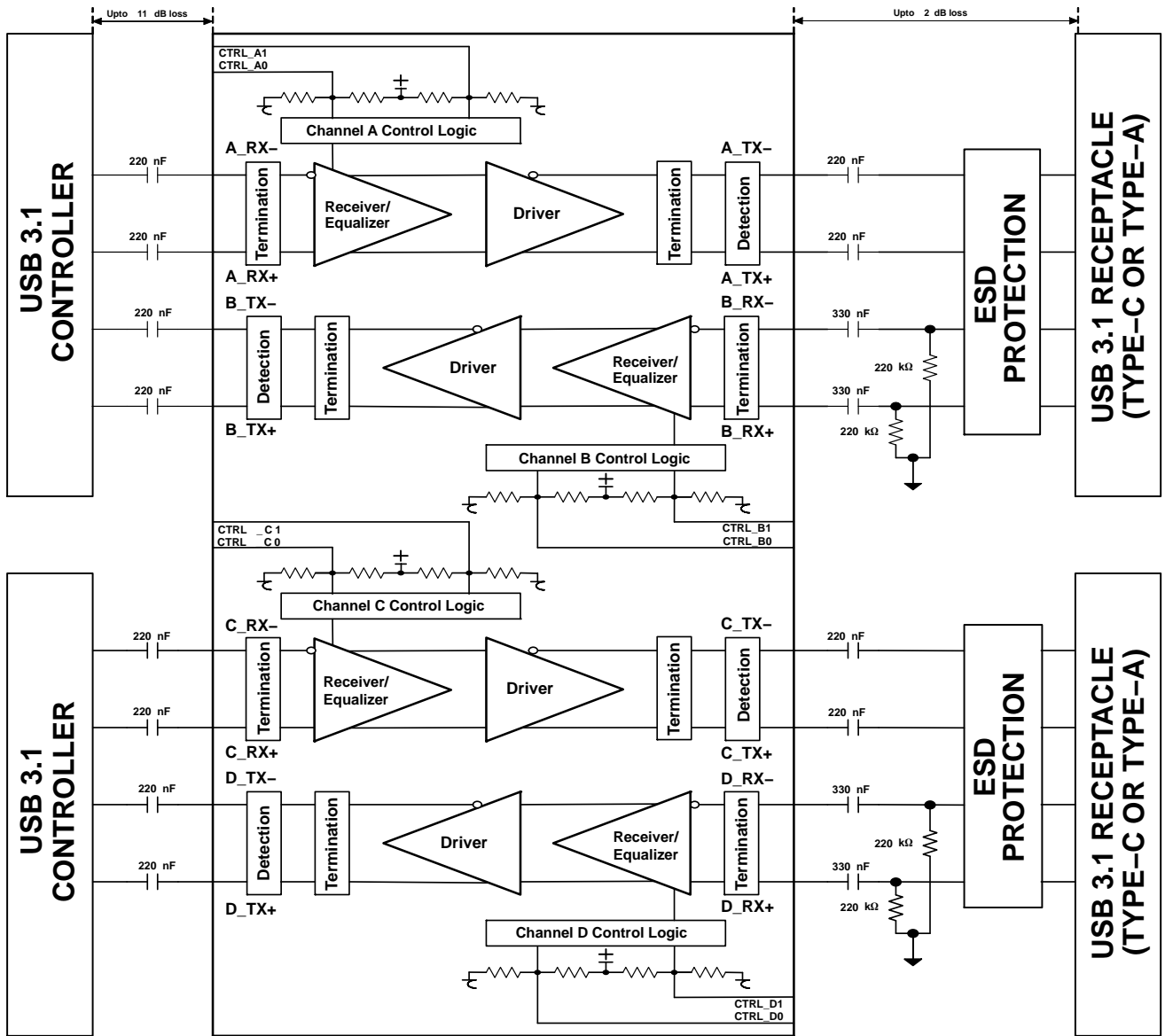

Figure 5. USB 3.1 Host Side NB7NPQ7042M Application

NB7NPQ7042M

Table 11. DESIGN REQUIREMENTS

Design Parameter	Value
Supply Voltage	3.3 V nominal, (3.135 V to 3.465 V)
Operation Mode (Control Pin Selection)	"F" Float by Default, to be adjusted based on application losses. See Table 2
AC Coupling Capacitors	220 nF nominal, 75 nF to 265 nF, see Figure 5
R _{ext}	68 kΩ, ±5%
RX Pull Down Resistors at Receptacle	200 KΩ to 220 KΩ
Power Supply Capacitors	100 nF to GND close to each Vcc pin, and 10 μF to GND on the Vcc plane
Trace loss of FR4 before NB7NPQ7042M	Up to 11 dB
Trace loss of FR4 after NB7NPQ7042M	Up To 2 dB. Keep as short as possible for best performance.
Linear Range at 5 GHz	900 mV differential
DC Flat Gain Options	-3 dB, -1.5 dB, 0 dB, 2 dB
Equalization Options	6.7 to 13 dB
Differential Trace Impedance	90 Ω ±10%

9. Trace loss of FR4 was estimated to have 1 dB of loss per 1 inch of FR4 length with matched impedance and no VIAS.

Typical Layout Practices

- RX and TX pairs should maintain as close to a 90 Ω differential impedance as possible.
- Limit the number of vias used on each data line. It is suggested that 2 or fewer are used.
- Traces should be routed as straight and symmetric as possible.
- RX and TX differential pairs should always be placed and routed on the same layer directly above a ground plane. This will help reduce EMI and noise on the data lines.
- Routing angles should be obtuse angles and kept to 135 degrees or larger.
- To minimize crosstalk, TX and RX data lines should be kept away from other high speed signals.

X2QFN34 3.1x4.3, 0.4P
CASE 722AL
ISSUE O

DATE 02 MAY 2017

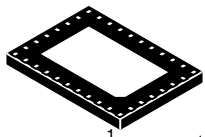

SCALE 4:1

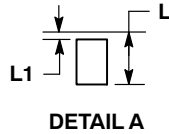
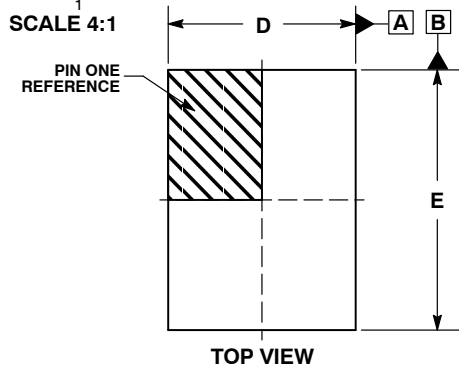

DETAIL A

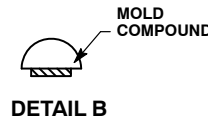
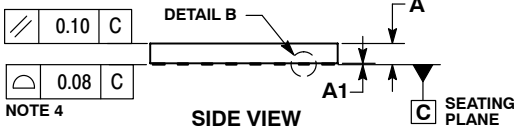

DETAIL B

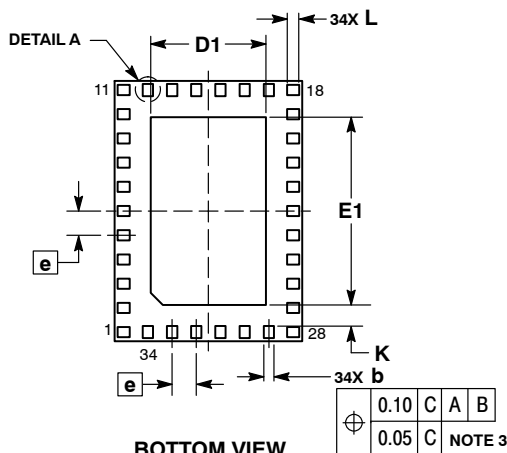

BOTTOM VIEW

RECOMMENDED SOLDERING FOOTPRINT

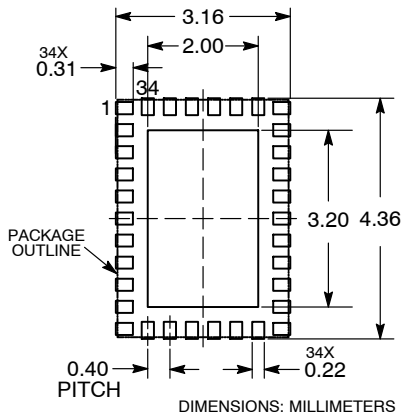

DIMENSIONS: MILLIMETERS

NOTES:

1. DIMENSIONING AND TOLERANCING PER ASME Y14.5M, 1994.
2. CONTROLLING DIMENSION: MILLIMETERS.
3. DIMENSION b APPLIES TO PLATED TERMINAL AND IS MEASURED BETWEEN 0.20 AND 0.25 MM FROM THE TERMINAL TIP.
4. COPLANARITY APPLIES TO THE EXPOSED PAD AS WELL AS THE PLATED TERMINALS.

MILLIMETERS			
DIM	MIN	NOM	MAX
A	0.30	0.35	0.40
A1	---	---	0.05
b	0.12	0.17	0.22
D	3.00	3.10	3.20
D1	1.80	1.90	2.00
E	4.20	4.30	4.40
E1	3.00	3.10	3.20
e	0.40 BSC		
K	0.35 REF		
L	0.20	0.25	0.30
L1	0.05 REF		

GENERIC MARKING DIAGRAM*

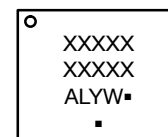

- XXXXX = Specific Device Code
- A = Assembly Location
- L = Wafer Lot
- Y = Year
- W = Work Week
- = Pb-Free Package

(Note: Microdot may be in either location)

*This information is generic. Please refer to device data sheet for actual part marking. Pb-Free indicator, "G" or microdot "▪", may or may not be present. Some products may not follow the Generic Marking.

DOCUMENT NUMBER:	98AON63532G	Electronic versions are uncontrolled except when accessed directly from the Document Repository. Printed versions are uncontrolled except when stamped "CONTROLLED COPY" in red.
DESCRIPTION:	X2QFN34 3.1X4.3, 0.4P	PAGE 1 OF 1

onsemi and ONSEMI are trademarks of Semiconductor Components Industries, LLC dba onsemi or its subsidiaries in the United States and/or other countries. onsemi reserves the right to make changes without further notice to any products herein. onsemi makes no warranty, representation or guarantee regarding the suitability of its products for any particular purpose, nor does onsemi assume any liability arising out of the application or use of any product or circuit, and specifically disclaims any and all liability, including without limitation special, consequential or incidental damages. onsemi does not convey any license under its patent rights nor the rights of others.

onsemi, **Onsemi**, and other names, marks, and brands are registered and/or common law trademarks of Semiconductor Components Industries, LLC dba "**onsemi**" or its affiliates and/or subsidiaries in the United States and/or other countries. **onsemi** owns the rights to a number of patents, trademarks, copyrights, trade secrets, and other intellectual property. A listing of **onsemi**'s product/patent coverage may be accessed at www.onsemi.com/site/pdf/Patent-Marking.pdf. **onsemi** reserves the right to make changes at any time to any products or information herein, without notice. The information herein is provided "as-is" and **onsemi** makes no warranty, representation or guarantee regarding the accuracy of the information, product features, availability, functionality, or suitability of its products for any particular purpose, nor does **onsemi** assume any liability arising out of the application or use of any product or circuit, and specifically disclaims any and all liability, including without limitation special, consequential or incidental damages. Buyer is responsible for its products and applications using **onsemi** products, including compliance with all laws, regulations and safety requirements or standards, regardless of any support or applications information provided by **onsemi**. "Typical" parameters which may be provided in **onsemi** data sheets and/or specifications can and do vary in different applications and actual performance may vary over time. All operating parameters, including "Typicals" must be validated for each customer application by customer's technical experts. **onsemi** does not convey any license under any of its intellectual property rights nor the rights of others. **onsemi** products are not designed, intended, or authorized for use as a critical component in life support systems or any FDA Class 3 medical devices or medical devices with a same or similar classification in a foreign jurisdiction or any devices intended for implantation in the human body. Should Buyer purchase or use **onsemi** products for any such unintended or unauthorized application, Buyer shall indemnify and hold **onsemi** and its officers, employees, subsidiaries, affiliates, and distributors harmless against all claims, costs, damages, and expenses, and reasonable attorney fees arising out of, directly or indirectly, any claim of personal injury or death associated with such unintended or unauthorized use, even if such claim alleges that **onsemi** was negligent regarding the design or manufacture of the part. **onsemi** is an Equal Opportunity/Affirmative Action Employer. This literature is subject to all applicable copyright laws and is not for resale in any manner.

ADDITIONAL INFORMATION

TECHNICAL PUBLICATIONS:

Technical Library: www.onsemi.com/design/resources/technical-documentation
onsemi Website: www.onsemi.com

ONLINE SUPPORT: www.onsemi.com/support

For additional information, please contact your local Sales Representative at www.onsemi.com/support/sales