

ecoSwitch™

Advanced Load Management

Controlled Load Switch with Low R_{ON}

NCP45610

The NCP45610 series of load management devices provide a component and area-reducing solution for efficient power domain switching with inrush current limit via soft start. These devices are designed to integrate control and driver functionality with a high performance low on-resistance power MOSFET in a single package offering safeguards and monitoring via fault protection and power-good signaling. This cost effective solution is ideal for power management and disconnect functions in USB ports and power management applications requiring low power consumption in a small footprint.

Features

- Advanced Controller with Charge Pump
- Integrated N-Channel MOSFET with Low R_{ON}
- Soft-Start via Controlled Slew Rate
- Adjustable Slew Rate Control
- Power Good Output
- Thermal Shutdown
- Under Voltage Lockout
- Over Current Protection
- Input Voltage Range 1 V to 13.5 V
- Extremely Low Standby Current
- Load Bleed (Quick Discharge)
- This is a Pb-free Device

Typical Applications

- Notebook and Tablet Computers
- Handheld & Mobile Electronics
- Portable Medical Devices
- Hard Drives
- Peripheral Ports

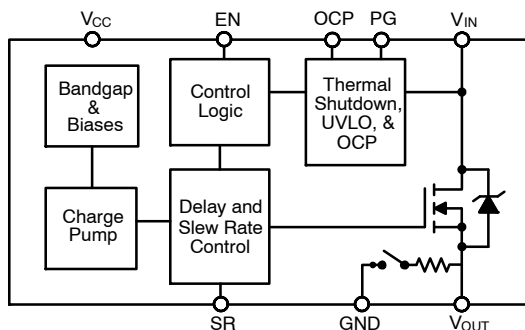

Figure 1. Block Diagram



ON Semiconductor®

www.onsemi.com

R_{ON} TYP	V_{CC}	V_{IN}	DC I_{MAX}
14.0	3.3 V	1.0 V	8 A
14.5	3.3 V	5 V	
15.9	3.3 V	12 V	

* I_{MAX} is defined as the maximum steady state current the load switch can pass at room ambient temperature without entering thermal lockout.



DFN8, 2x2
CASE 506CN

MARKING DIAGRAM

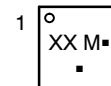

XX = Specific Device Code
M = Date Code
▪ = Pb-free Package

(Note: Microdot may be in either location)

PIN CONFIGURATION 2x2 DFN

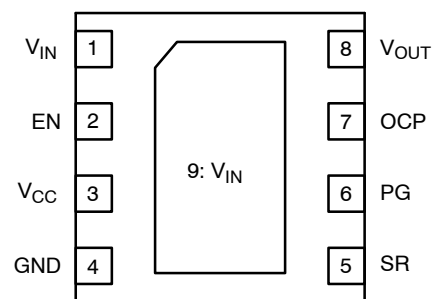

(Top View)

ORDERING INFORMATION

Device	Package	Shipping
NCP45610IMNTWG	DFN8	TBD

NCP45610

Table 1. PIN DESCRIPTION

Pin	Name	Function
1, 9	V _{IN}	Input voltage (1 V – 13.5 V)
2	EN	Active–high digital input used to turn on the MOSFET driver, pin has an internal pull down resistor to GND.
3	V _{CC}	Driver supply voltage (3.0 V – 5.5 V)
4,	GND	Driver ground
5	SR	Slew rate adjustment made with an external capacitor to GND; float if not used
6	PG	Power Good Output; Open drain, should be tied to V _{CC} with a pullup resistor (100kΩ typical)
7	OCP	Over–current protection trip point adjustment made with a voltage applied (1 V – 1.2 V), pin has an internal pull up resistor to EN; float if over–current protection is needed
8	V _{OUT}	Source of MOSFET connected to load. Includes an internal bleed resistor to GND.

Table 2. ABSOLUTE MAXIMUM RATINGS

Rating	Symbol	Value	Unit
Supply Voltage Range	V _{CC}	–0.3 to 6	V
Input Voltage Range	V _{IN}	–0.3 to 18	V
Output Voltage Range	V _{OUT}	–0.3 to 18	V
EN Input Voltage Range	V _{EN}	–0.3 to (V _{CC} + 0.3)	V
PG Output Voltage Range (Note 2)	V _{PG}	–0.3 to 6	V
OCP Input Voltage Range	V _{OCP}	–0.3 to 6	V
Thermal Resistance, Junction–to–Ambient, Steady State (Note 1)	R _{θJA}	59.9	°C/W
Thermal Resistance, Junction–to–Case (V _{IN} Paddle)	R _{θJC}	7.9	°C/W
Continuous MOSFET Current @ T _A = 25°C (Note 1)	I _{MAX}	24	A
Total Power Dissipation @ T _A = 25°C (Note 1) Derate above T _A = 25°C	P _D	3.49 34.9	W mW/°C
Storage Temperature Range	T _{STG}	–40 to 150	°C
Lead Temperature, Soldering (10 sec.)	T _{SLD}	260	°C
ESD Capability, Human Body Model (Note 3 and 4)	ESD _{HBM}	2.0	kV
ESD Capability, Charged Device Model (Note 3)	ESD _{CDM}	1.0	kV
Latch–up Current Immunity (Note 3 and 4)	LU	100	mA
OFF to ON Transition Energy Dissipation Limit (See application section)	E _{TRANS}	50	mJ

Stresses exceeding those listed in the Maximum Ratings table may damage the device. If any of these limits are exceeded, device functionality should not be assumed, damage may occur and reliability may be affected.

- Surface–mounted on FR4 board using the minimum recommended pad size, 1 oz Cu.
- PG is an open–drain output that requires an external pull–up resistor > 1 kΩ to an external voltage source.
- Tested by the following methods @ T_A = 25°C:
 ESD Human Body Model tested per JESD22–A114
 ESD Charged Device Model per ESD STM5.3.1
 Latch–up Current tested per JESD78
- Rating is for all pins except for V_{IN} and V_{OUT} which are tied to the internal MOSFET’s Drain and Source. Typical MOSFET ESD performance for V_{IN} and V_{OUT} should be expected and these devices should be treated as ESD sensitive.

NCP45610

Table 3. OPERATING RANGES

Rating	Symbol	Min	Max	Unit
Supply Voltage	V_{CC}	3	5.5	V
Input Voltage	V_{IN}	1	13.5	V
OCP Input Voltage	V_{OCP}	0	1	V
Ground	GND		0	V
Ambient Temperature	T_A	-40	85	°C
Junction Temperature	T_J	-40	125	°C

Functional operation above the stresses listed in the Recommended Operating Ranges is not implied. Extended exposure to stresses beyond the Recommended Operating Ranges limits may affect device reliability.

Table 4. ELECTRICAL CHARACTERISTICS ($T_J = 25^\circ\text{C}$, $V_{CC} = 3\text{ V} - 5.5\text{ V}$, unless otherwise specified)

Parameter	Conditions	Symbol	Min	Typ	Max	Unit
-----------	------------	--------	-----	-----	-----	------

MOSFET

On-Resistance	$V_{CC} = 3.3\text{ V}; V_{IN} = 1\text{ V}$	R_{ON}		14.0	16.5	m Ω
	$V_{CC} = 3.3\text{ V}; V_{IN} = 5\text{ V}$			14.5	17	
	$V_{CC} = 3.3\text{ V}; V_{IN} = 12\text{ V}$			15.9	18.5	
	$V_{CC} = 3.3\text{ V}; V_{IN} = 13.5\text{ V}$			17.4	21	
Leakage Current (Note 5)	$V_{EN} = 0\text{ V}; V_{IN} = 13.5\text{ V}$	I_{LEAK}		10	100	nA

CONTROLLER

Supply Standby Current (Note 6)	$V_{EN} = 0\text{ V}$	I_{STBY}		2.7	5	μA
Supply Dynamic Current (Note 7)	$V_{EN} = V_{CC} = 3\text{ V}; V_{IN} = 12\text{ V}$	I_{DYN}		430	750	μA
	$V_{EN} = V_{CC} = 5.5\text{ V}; V_{IN} = 1\text{ V}$			800	1000	
Internal Load Bleed Resistance (Note 8)	$V_{EN} = 0\text{ V}$	R_{BLEED}	300	600	1000	Ω
Internal Bleed Leakage Current		I_{BLEED}		14	80	μA
EN Input High Voltage		V_{IH}	2			V
EN Input Low Voltage		V_{IL}			0.8	V
EN Pull Down Resistance		R_{PD}	80	100	120	k Ω
PG Output Low Voltage	$I_{SINK} = 5\text{ mA}$	V_{OL}		0.13	0.2	V
PG Output Leakage Current	$V_{TERM} = 3.3\text{ V}$	I_{OH}		5	100	nA
Slew Rate Control Constant (Note 9)	$V_{IN} = 5\text{ V}; V_{CC} = 3\text{ V}$	K_{SR}	22	31	38	μA

FAULT PROTECTIONS

Thermal Shutdown Threshold (Note 10)		T_{SDT}		155		°C
Thermal Shutdown Hysteresis (Note 10)		T_{HYS}		20		°C
V_{IN} Undervoltage Lockout Threshold	V_{IN} falling	V_{UV_FA}	670	710	750	mV
V_{IN} Undervoltage Lockout Hysteresis	V_{IN} rising	V_{UV_RI}	755	795	840	mV
Over-Current Protection Trip Current (Note 12)	$V_{OCP} = 0\text{ V}$	I_{TRIP_OCP}		3.5		A
Over-Current Protection Blanking Time	$V_{CC} = 3\text{ V}$	t_{OCP}	2.0	3.5	5.0	ms
OCP Pull Up Resistance (Note 11)		R_{OCP}	200	250	300	k Ω
Short-Circuit Protection Trip Voltage	$V_{IN} < 4.5\text{ V}$	V_{SC_LVIN}	110	150	190	mV
	$V_{IN} > 4.5\text{ V}$	V_{SC_HVIN}	135	160	190	mV

Product parametric performance is indicated in the Electrical Characteristics for the listed test conditions, unless otherwise noted. Product performance may not be indicated by the Electrical Characteristics if operated under different conditions.

5. Average current from V_{IN} to V_{OUT} with MOSFET turned off.
6. Average current from V_{CC} to GND with MOSFET turned off.
7. Average current from V_{CC} to GND after charge up time of MOSFET.
8. Resistance from V_{OUT} to GND when the MOSFET driver is disabled.
9. See Applications Information section for details on how to adjust the gate slew rate.
10. Operation above $T_J = 125^\circ\text{C}$ is not guaranteed.
11. Internal resistor from OCP to EN used to pull up on OCP pin if not driven.
12. Min and max trip OCP trip currents are not guaranteed but typically are accurate within $\pm 1.5\text{ A}$.

NCP45610

Table 5. SWITCHING CHARACTERISTICS ($T_J = 25^\circ\text{C}$ unless otherwise specified) (Notes 13 and 14)

Parameter	Conditions	Symbol	Min	Typ	Max	Unit
Output Slew Rate – Default	$V_{CC} = 3.0\text{ V}; V_{IN} = 1.0\text{ V}$	SR		18.5		V/ms
	$V_{CC} = 5.5\text{ V}; V_{IN} = 1.0\text{ V}$			18		
	$V_{CC} = 3.0\text{ V}; V_{IN} = 5.0\text{ V}$		11	19.3	25	
	$V_{CC} = 3.0\text{ V}; V_{IN} = 13.5\text{ V}$			22		
	$V_{CC} = 5.5\text{ V}; V_{IN} = 13.5\text{ V}$			23		
Output Turn-on Delay	$V_{CC} = 3.0\text{ V}; V_{IN} = 1.0\text{ V}$	T_{ON}		140		μs
	$V_{CC} = 5.5\text{ V}; V_{IN} = 1.0\text{ V}$			110		
	$V_{CC} = 3.0\text{ V}; V_{IN} = 5.0\text{ V}$		50	165	230	
	$V_{CC} = 3.0\text{ V}; V_{IN} = 13.5\text{ V}$			200		
	$V_{CC} = 5.5\text{ V}; V_{IN} = 13.5\text{ V}$			190		
Output Turn-off Delay	$V_{CC} = 3.0\text{ V}; V_{IN} = 1.0\text{ V}$	T_{OFF}		2.1		μs
	$V_{CC} = 5.5\text{ V}; V_{IN} = 1.0\text{ V}$			1.6		
	$V_{CC} = 3.0\text{ V}; V_{IN} = 13.5\text{ V}$	T_{OFF}		0.5		
	$V_{CC} = 5.5\text{ V}; V_{IN} = 13.5\text{ V}$			0.4		
Power Good Turn-on Time	$V_{CC} = 3.0\text{ V}; V_{IN} = 1.0\text{ V}$	$T_{PG,ON}$		0.70		ms
	$V_{CC} = 5.5\text{ V}; V_{IN} = 1.0\text{ V}$			0.65		
	$V_{CC} = 3.0\text{ V}; V_{IN} = 5.0\text{ V}$		0.4	0.8	1.8	
	$V_{CC} = 3.0\text{ V}; V_{IN} = 13.5\text{ V}$			1.33		
	$V_{CC} = 5.5\text{ V}; V_{IN} = 13.5\text{ V}$			0.9		
Power Good Turn-off Time	$V_{CC} = 3.0\text{ V}; V_{IN} = 1.0\text{ V}$	$T_{PG,OF}$		21		ns
	$V_{CC} = 5.5\text{ V}; V_{IN} = 1.0\text{ V}$			15		
	$V_{CC} = 3.0\text{ V}; V_{IN} = 13.5\text{ V}$			21		
	$V_{CC} = 5.5\text{ V}; V_{IN} = 13.5\text{ V}$			15		

13. See below figure for Test Circuit and Timing Diagram.

14. Tested with the following conditions: $V_{TERM} = V_{CC}$; $R_{PG} = 100\text{ k}\Omega$; $R_L = 10\ \Omega$; $C_L = 0.1\ \mu\text{F}$.

NCP45610

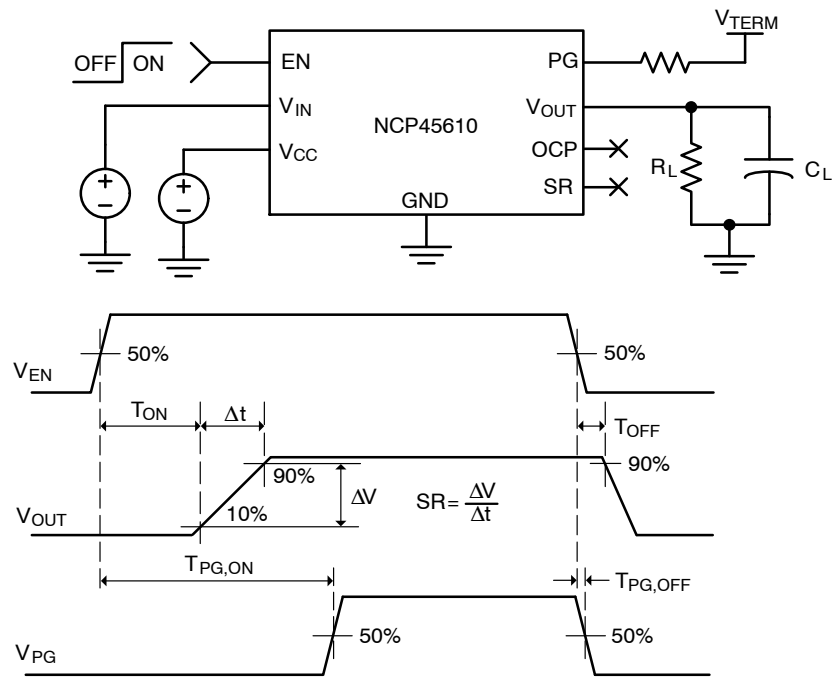

Figure 2. Switching Characteristics Test Circuit and Timing Diagram

NCP45610

TYPICAL CHARACTERISTICS

($T_J = 25^\circ\text{C}$ unless otherwise specified)

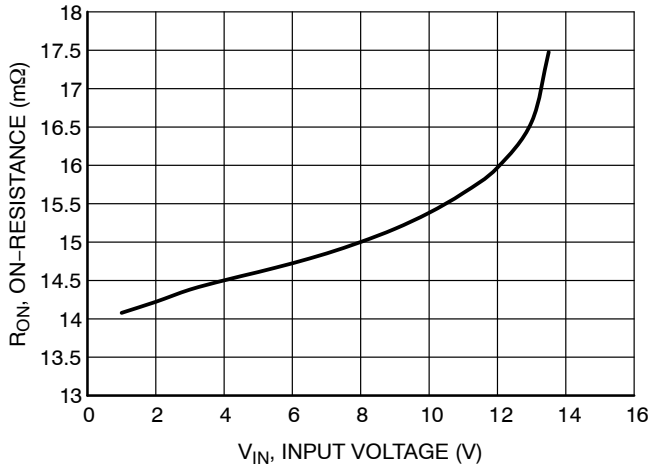

Figure 3. On-Resistance vs. Input Voltage

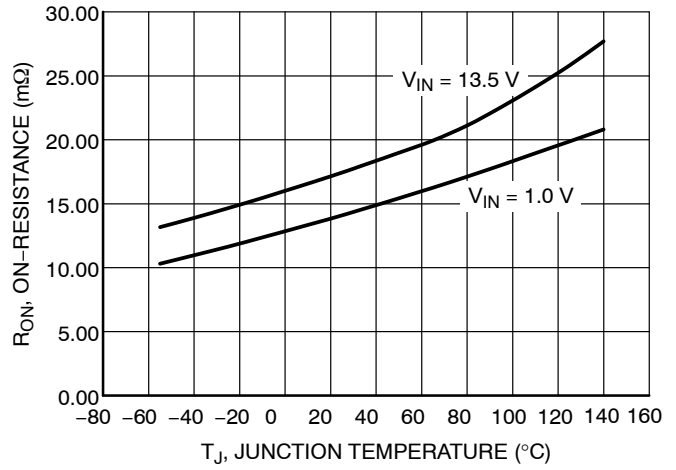

Figure 4. On-Resistance vs. Temperature

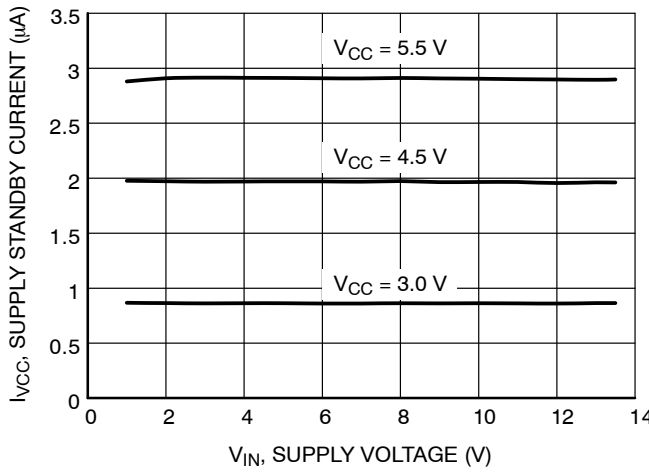

Figure 5. Supply Standby Current vs. Supply Voltage

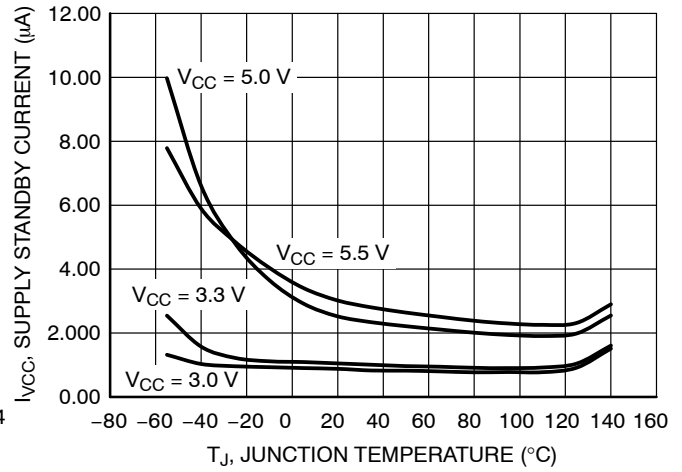

Figure 6. Supply Standby Current vs. Temperature

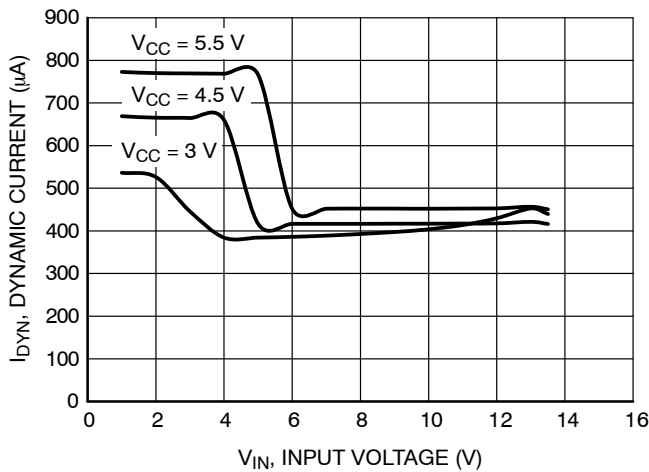

Figure 7. Dynamic Current vs. Input Voltage

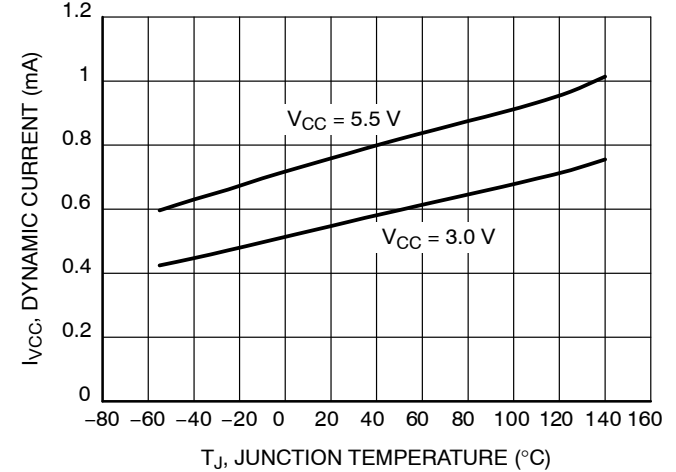

Figure 8. Supply Dynamic Current vs. Temperature

NCP45610

TYPICAL CHARACTERISTICS

($T_J = 25^\circ\text{C}$ unless otherwise specified)

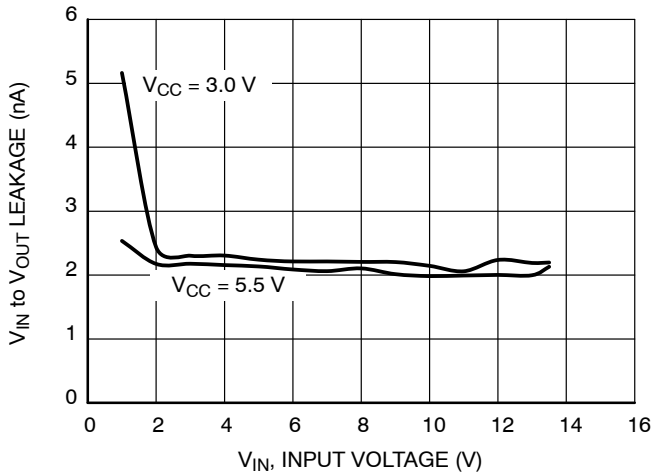

Figure 9. V_{IN} to V_{OUT} Leakage with $EN = 0\text{ V}$

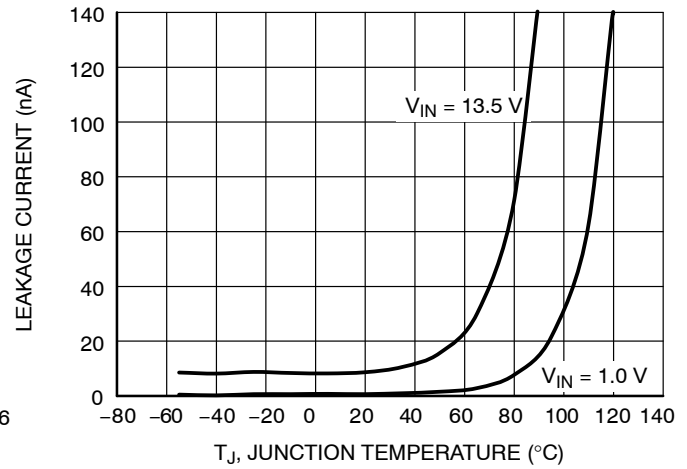

Figure 10. V_{IN} to V_{OUT} Leakage Over Temperature ($EN = 0\text{ V}$)

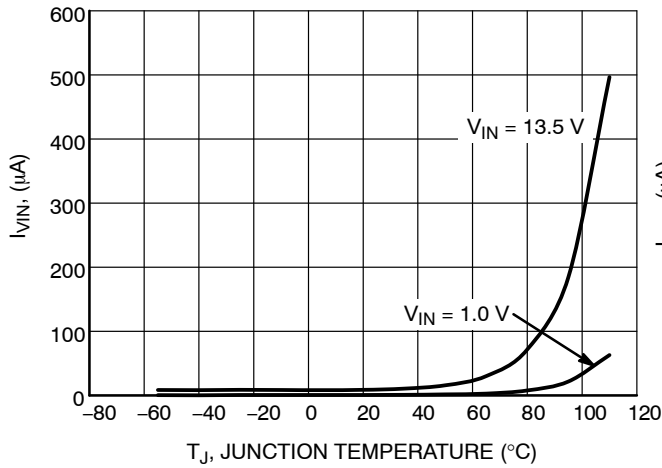

Figure 11. V_{IN} Controller Current vs. Temperature ($EN = 0\text{ V}$)

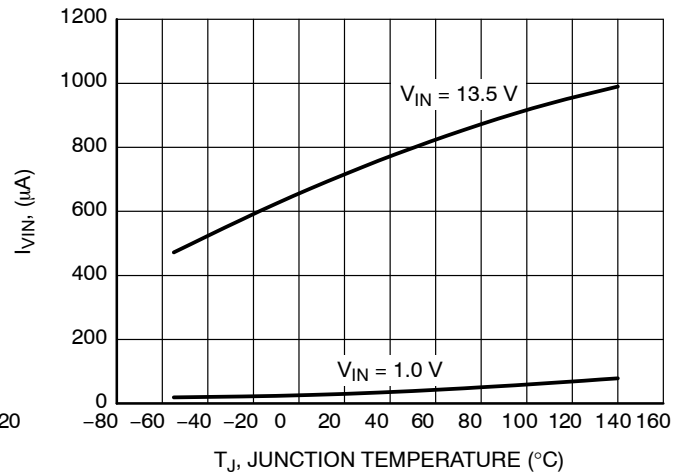

Figure 12. V_{IN} Controller Current vs. Temperature ($EN = \text{HIGH}$)

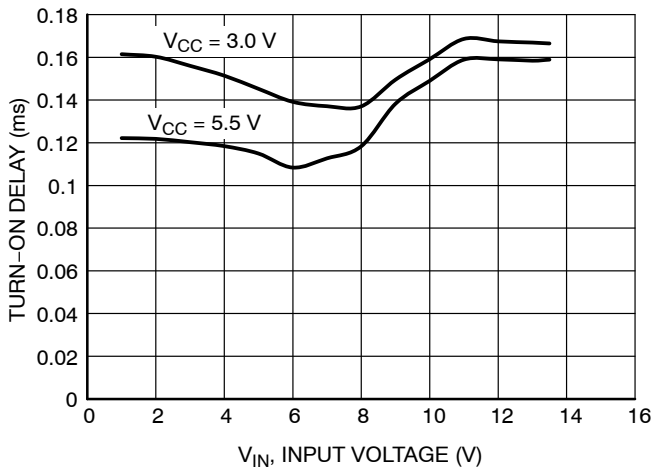

Figure 13. Output Turn-on Delay vs. Input Voltage

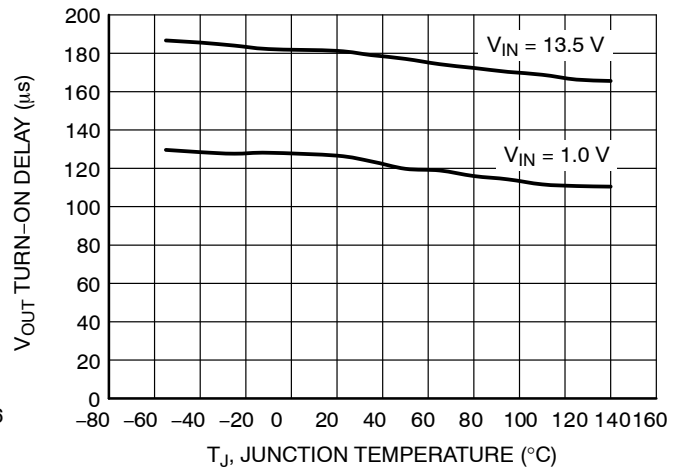

Figure 14. Output Turn-on Delay vs. Temperature

NCP45610

TYPICAL CHARACTERISTICS

($T_J = 25^\circ\text{C}$ unless otherwise specified)

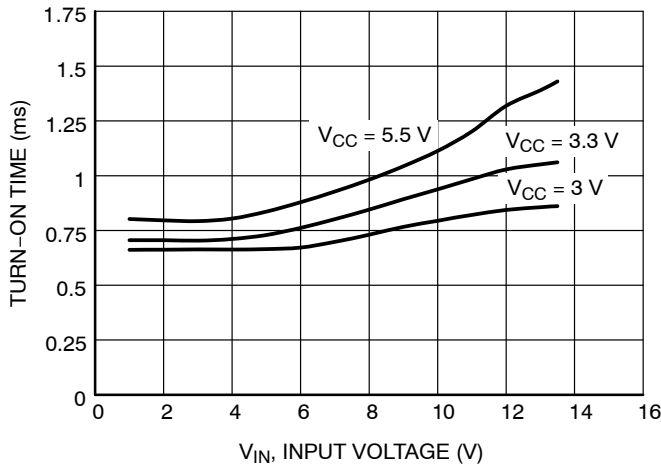

Figure 15. Power Good Turn On Turn vs. Input Voltage

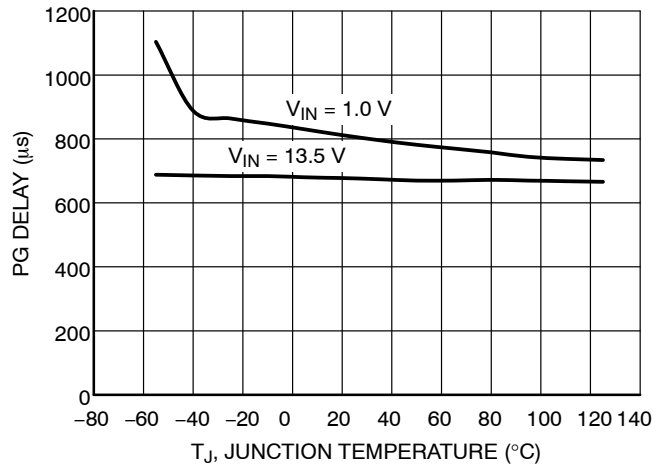

Figure 16. Power Good Turn-on Delay vs. Temperature

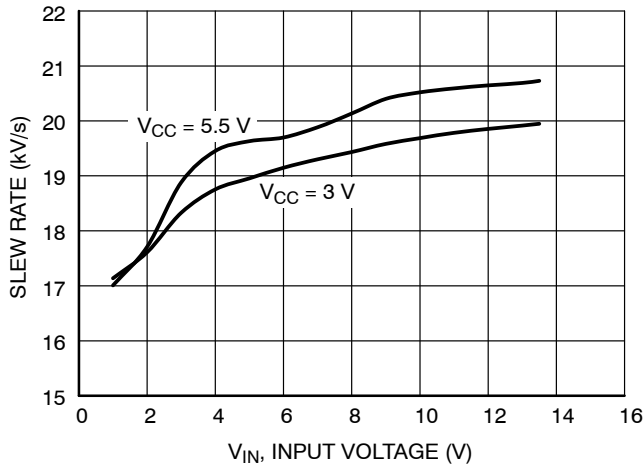

Figure 17. Default Slew Rate vs. Input Voltage (SR pin = Floating)

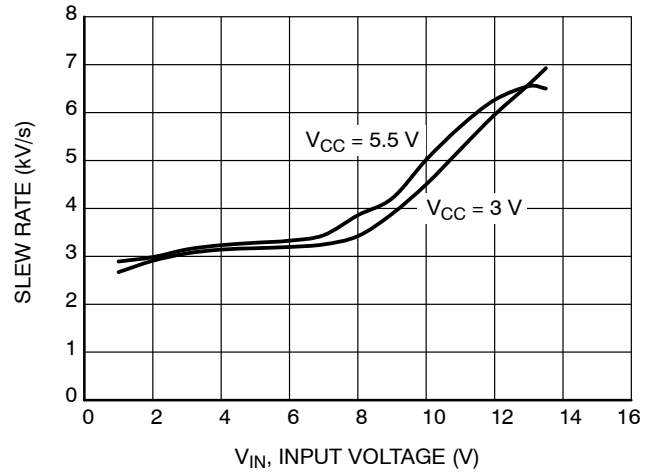

Figure 18. Slew Rate vs. Input Voltage (SR Pin = 10 nF to GND)

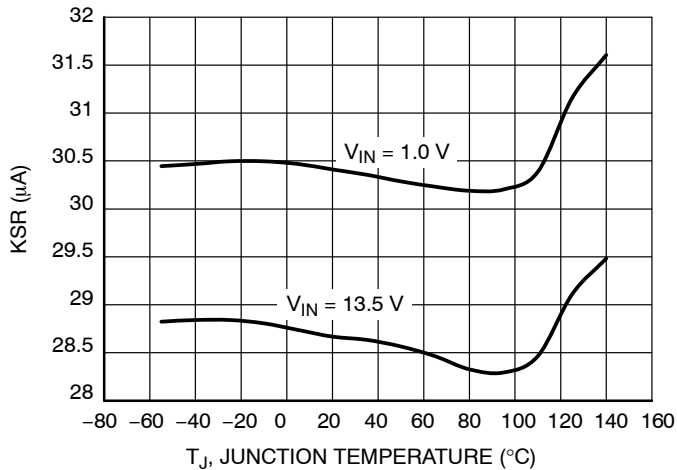

Figure 19. KSR vs. Temperature

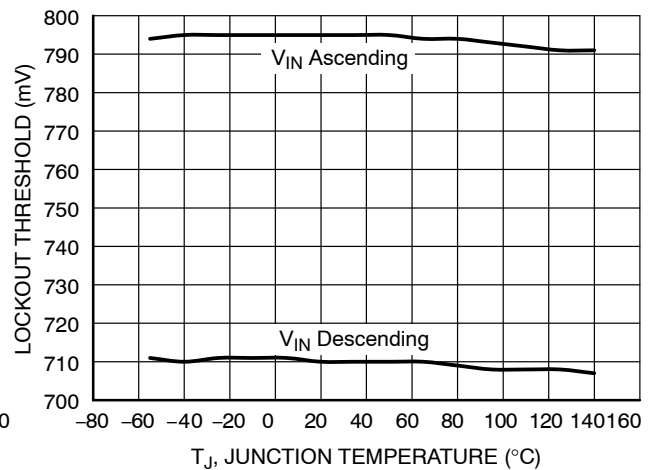

Figure 20. UVLO Trip Voltage vs. Temperature

APPLICATIONS INFORMATION

Power Sequencing

The NCP45610 will function with any power sequence, but the output turn-on delay and slew rate performance may vary from what is specified. To achieve the specified performance, there are two recommended power sequences:

1. $V_{CC} \rightarrow V_{IN} \rightarrow V_{EN}$
2. $V_{IN} \rightarrow V_{CC} \rightarrow V_{EN}$

V_{CC} must be at 2 V or higher when EN is asserted to ensure proper operation.

Enable Control

The NCP45610 part allows for enabling the MOSFET in an active-high configuration. When the EN pin is at a logic high level and the VCC supply pin has an adequate voltage applied, the MOSFET will be enabled. Similarly, when the EN pin is at a logic low level, the MOSFET will be disabled. After disabling the NCP45610 at least 400 ms must pass before the part is enabled again to ensure proper slew rate. An internal pull down resistor to ground on the EN pin ensures that the MOSFET will be disabled when not being driven.

Load Bleed

The NCP45610 device has an on-chip bleed resistor that is used to bleed the charge off of the load to ground after the MOSFET has been disabled. In series with the bleed resistor is a bleed switch that is enabled whenever the MOSFET is disabled. Delays are added to the enable of this switch to ensure that both the MOSFET and the bleed switch are not concurrently active.

Over-Current and Short-Circuit protection

The NCP45610 devices are equipped with short-circuit protection and an optional over-current protection that are used to help protect the part and the system from a sudden high-current event, such as the output, V_{OUT} , being shorted to ground. This circuitry is only active when the gate of the MOSFET is fully driven.

Once active, the circuitry monitors the difference in the voltage on the V_{IN} pin and the voltage on the V_{OUT} pin. When the difference is equal to the short-circuit protection threshold voltage, the MOSFET is immediately turned off and the load bleed is activated. The part remains latched in this off state until the V_{CC} - supply voltage is cycled. When latched off the behavior of the part if EN is toggled is not defined. After the V_{CC} supply voltage is cycled and EN is high, the MOSFET will be turned on in a controlled fashion with the normal output turn-on delay and slew rate.

The over-current protection can be enabled to allow for protection before the short-circuit threshold. If this lower threshold is not needed, then OCP can be left floating. By tying the OCP pin to ground the NCP45610 will enable the over-current protection. In the event the OCP threshold is exceeded, the MOSFET will shut down after the blanking time if the voltage difference remains greater than the threshold. Like the short-circuit protection, the part remains

latched in this off state until the V_{CC} - supply voltage is cycled. When latched off the behavior of the part if EN is toggled is not defined. After the V_{CC} supply voltage is cycled and EN is high, the MOSFET will be turned on in a controlled fashion with the normal output turn-on delay and slew rate.

Thermal Shutdown

The thermal shutdown of the NCP45610 device protects the part from internally or externally generated excessive temperatures. This circuitry is disabled when EN is not active to reduce standby current. When an over-temperature condition is detected, the MOSFET is immediately turned off and the load bleed is activated.

The part comes out of thermal shutdown when the junction temperature decreases to a safe operating temperature as dictated by the thermal hysteresis. Upon exiting a thermal shutdown state, and if EN remains active, the MOSFET will be turned on in a controlled fashion with the normal output turn-on delay and slew rate.

Under Voltage Lockout

The under voltage lockout of the NCP45610 device turns the MOSFET off and activates the load bleed when the input voltage, V_{IN} , drops below the undervoltage lockout threshold. This circuitry is disabled when EN is not active to reduce standby current.

If the V_{IN} voltage rises above the undervoltage lockout threshold, and EN remains active, the MOSFET will be turned on in a controlled fashion with the normal output turn-on delay and slew rate.

Power Good

The NCP45610 devices have a power good output (PG) that can be used to indicate when the gate of the MOSFET is fully charged. The PG pin is an active-high, open-drain output that requires an external pull up resistor, R_{PG} , greater than or equal to 100 k Ω to an external voltage source, that is compatible with input levels of all devices connected to this pin.

The power good output can be used as the enable signal for other active-high devices in the system. This allows for guaranteed by design power sequencing and reduces the number of enable signals needed from the system controller. If the power good feature is not used in the application, the PG pin should be tied to GND.

Slew Rate Control

The NCP45610 device is equipped with controlled output slew rate which provides soft start functionality. This limits the inrush current caused by capacitor charging and enables these devices to be used in hot swapping applications.

The slew rate can be decreased with an external capacitor added between the SR pin and ground. With an external capacitor present, the slew rate can be determined by the following equation:

$$\text{Slew Rate} = \frac{K_{SR}}{C_{SR}} \text{ [V/s]} \quad (\text{eq. 1})$$

where K_{SR} is the specified slew rate control constant, found on page 3, and C_{SR} is the capacitor added between the SR pin and ground. Note that the slew rate of the device will always be the lower of the default slew rate and the adjusted slew rate. Therefore, if the C_{SR} is not large enough to decrease the slew rate more than the specified default value, the slew rate of the device will be the default value.

Capacitive Load

The peak in-rush current associated with the initial charging of the application load capacitance needs to stay below the specified I_{max} . CL(capacitive load) should be less than C_{max} as defined by the following equation:

$$C_{max} = \frac{I_{max}}{SR_{typ}} \quad (\text{eq. 2})$$

where I_{max} is the maximum load current, and SR_{typ} is the typical default slew rate when no external load capacitor is added to the SR pin.

OFF to ON Transition Energy Dissipation

The energy dissipation due to load current traveling from V_{IN} to V_{OUT} is very low during steady state operation due to the low R_{ON} . When the EN signal is asserted high, the load switch transitions from an OFF state to an ON state. During this time, the resistance from V_{IN} to V_{OUT} transitions from high impedance to R_{ON} , and additional energy is dissipated in the device for a short period of time. The worst case energy dissipated during the OFF to ON transition can be approximated by the following equation:

$$E = 0.5 \cdot V_{IN} \cdot (I_{INRUSH} + 0.8 \cdot I_{LOAD}) \cdot dt \quad (\text{eq. 3})$$

Where V_{IN} is the voltage on the V_{IN} pin, I_{INRUSH} is the inrush current caused by capacitive loading on V_{OUT} , and dt is the time it takes V_{OUT} to rise from 0 V to V_{IN} . I_{INRUSH} can be calculated using the following equation:

$$I_{INRUSH} = \frac{dv}{dt} \cdot C_L \quad (\text{eq. 4})$$

Where dv/dt is the programmed slew rate, and C_L is the capacitive loading on V_{OUT} . To prevent thermal lockout or damage to the device, the energy dissipated during the OFF to ON transition should be limited to E_{TRANS} listed in absolute maximum ratings table.

ecoSWITCH LAYOUT GUIDELINES

Electrical Layout Considerations

Correct physical PCB layout is important for proper low noise accurate operation of all ecoSWITCH products.

Power Planes: The ecoSWITCH is optimized for extremely low R_{on} resistance, however, improper PCB layout can substantially increase source to load series resistance by adding PCB board parasitic resistance. Solid connections to the V_{IN} and V_{OUT} pins of the ecoSWITCH to copper planes should be used to achieve low series resistance and good thermal dissipation. The ecoSWITCH requires ample heat dissipation for correct thermal lockout operation. The internal FET dissipates load condition dependent amounts of power in the milliseconds following the rising edge of enable, and providing good thermal conduction from the packaging to the board is critical. Direct coupling of V_{IN} to V_{OUT} should be avoided, as this will adversely affect slew rates.

MECHANICAL CASE OUTLINE

PACKAGE DIMENSIONS

ON Semiconductor®



SCALE 2:1

DFN8 2x2, 0.5P
CASE 506CN
ISSUE O

DATE 17 JUL 2013

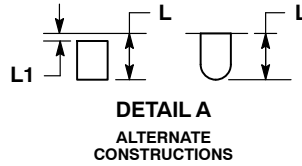
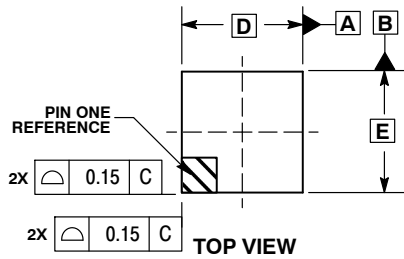

NOTES:

1. DIMENSIONING AND TOLERANCING PER ASME Y14.5M, 1994.
2. CONTROLLING DIMENSION: MILLIMETERS.
3. DIMENSION b APPLIES TO PLATED TERMINAL AND IS MEASURED BETWEEN 0.15 AND 0.30 MM FROM TERMINAL TIP.
4. COPLANARITY APPLIES TO THE EXPOSED PAD AS WELL AS THE TERMINALS.

DIM	MILLIMETERS	
	MIN	MAX
A	0.80	1.00
A1	0.00	0.05
A3	0.20 REF	
b	0.20	0.30
D	2.00 BSC	
D2	1.50	1.70
E	2.00 BSC	
E2	0.80	1.00
e	0.50 BSC	
K	0.27 REF	
L	0.17	0.38
L1	---	0.15

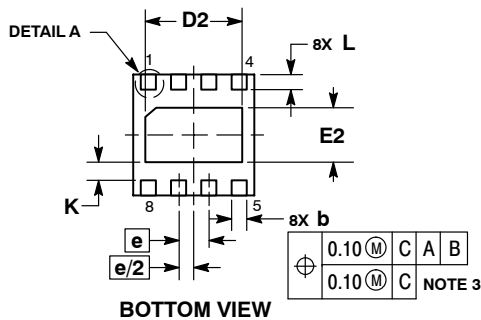
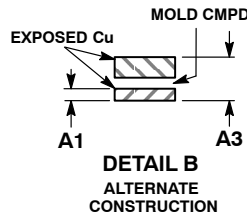
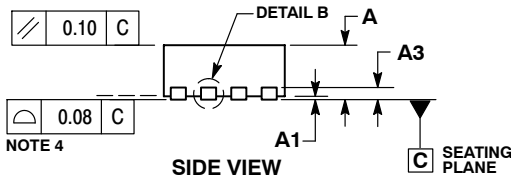

GENERIC MARKING DIAGRAM*

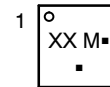

- XX = Specific Device Code
- M = Date Code
- = Pb-Free Package

(Note: Microdot may be in either location)
*This information is generic. Please refer to device data sheet for actual part marking. Pb-Free indicator, "G" or microdot "▪", may or may not be present.

RECOMMENDED SOLDERING FOOTPRINT*

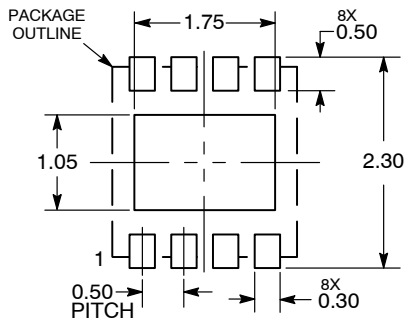

DIMENSIONS: MILLIMETERS

*For additional information on our Pb-Free strategy and soldering details, please download the ON Semiconductor Soldering and Mounting Techniques Reference Manual, SOLDERRM/D.

DOCUMENT NUMBER:	98AON76135F	Electronic versions are uncontrolled except when accessed directly from the Document Repository. Printed versions are uncontrolled except when stamped "CONTROLLED COPY" in red.
DESCRIPTION:	DFN8 2X2, 0.5P	PAGE 1 OF 1

ON Semiconductor and ON are trademarks of Semiconductor Components Industries, LLC dba ON Semiconductor or its subsidiaries in the United States and/or other countries. ON Semiconductor reserves the right to make changes without further notice to any products herein. ON Semiconductor makes no warranty, representation or guarantee regarding the suitability of its products for any particular purpose, nor does ON Semiconductor assume any liability arising out of the application or use of any product or circuit, and specifically disclaims any and all liability, including without limitation special, consequential or incidental damages. ON Semiconductor does not convey any license under its patent rights nor the rights of others.

onsemi, **Onsemi**, and other names, marks, and brands are registered and/or common law trademarks of Semiconductor Components Industries, LLC dba "**onsemi**" or its affiliates and/or subsidiaries in the United States and/or other countries. **onsemi** owns the rights to a number of patents, trademarks, copyrights, trade secrets, and other intellectual property. A listing of **onsemi**'s product/patent coverage may be accessed at www.onsemi.com/site/pdf/Patent-Marking.pdf. **onsemi** reserves the right to make changes at any time to any products or information herein, without notice. The information herein is provided "as-is" and **onsemi** makes no warranty, representation or guarantee regarding the accuracy of the information, product features, availability, functionality, or suitability of its products for any particular purpose, nor does **onsemi** assume any liability arising out of the application or use of any product or circuit, and specifically disclaims any and all liability, including without limitation special, consequential or incidental damages. Buyer is responsible for its products and applications using **onsemi** products, including compliance with all laws, regulations and safety requirements or standards, regardless of any support or applications information provided by **onsemi**. "Typical" parameters which may be provided in **onsemi** data sheets and/or specifications can and do vary in different applications and actual performance may vary over time. All operating parameters, including "Typicals" must be validated for each customer application by customer's technical experts. **onsemi** does not convey any license under any of its intellectual property rights nor the rights of others. **onsemi** products are not designed, intended, or authorized for use as a critical component in life support systems or any FDA Class 3 medical devices or medical devices with a same or similar classification in a foreign jurisdiction or any devices intended for implantation in the human body. Should Buyer purchase or use **onsemi** products for any such unintended or unauthorized application, Buyer shall indemnify and hold **onsemi** and its officers, employees, subsidiaries, affiliates, and distributors harmless against all claims, costs, damages, and expenses, and reasonable attorney fees arising out of, directly or indirectly, any claim of personal injury or death associated with such unintended or unauthorized use, even if such claim alleges that **onsemi** was negligent regarding the design or manufacture of the part. **onsemi** is an Equal Opportunity/Affirmative Action Employer. This literature is subject to all applicable copyright laws and is not for resale in any manner.

ADDITIONAL INFORMATION

TECHNICAL PUBLICATIONS:

Technical Library: www.onsemi.com/design/resources/technical-documentation
onsemi Website: www.onsemi.com

ONLINE SUPPORT: www.onsemi.com/support

For additional information, please contact your local Sales Representative at www.onsemi.com/support/sales