

Linear Voltage Regulator - Ultra-Low Iq, Wide Input Voltage, Low Dropout

50 mA

NCP715

The NCP715 is 50 mA LDO Linear Voltage Regulator. It is a very stable and accurate device with ultra-low ground current consumption (4.7 μ A over the full output load range) and a wide input voltage range (up to 24 V). The regulator incorporates several protection features such as Thermal Shutdown and Current Limiting.

Features

- Operating Input Voltage Range: 2.5 V to 24 V
- Fixed Voltage Options Available: 1.2 V to 5.3 V
- Ultra Low Quiescent Current: Max. 4.7 μ A Over Full Load and Temperature
- $\pm 2\%$ Accuracy Over Full Load, Line and Temperature Variations
- PSRR: 52 dB at 100 kHz
- Noise: 190 μ V_{RMS} from 200 Hz to 100 kHz
- Thermal Shutdown and Current Limit protection
- Available in XDFN6 1.5 x 1.5 mm, SC-70 (SC-88A) and TSOP-5 Packages
- These are Pb-Free Devices

Typical Applications

- Portable Equipment
- Communication Systems

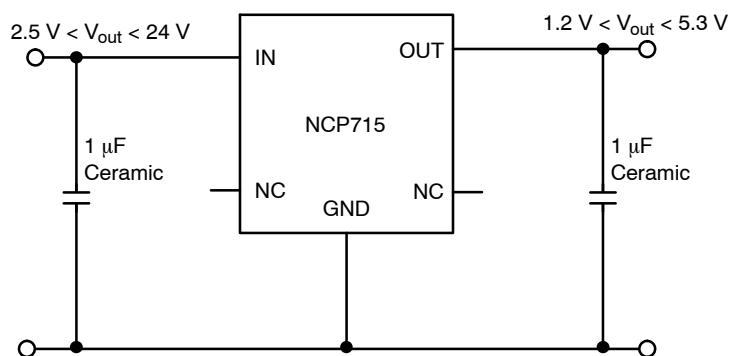
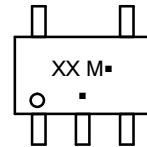
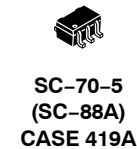
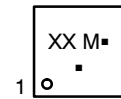
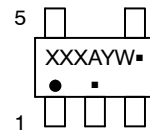

Figure 1. Typical Application Schematic

MARKING DIAGRAMS



XX = Specific Device Code
M = Date Code
▪ = Pb-Free Package
(Note: Microdot may be in either location)



XXX = Specific Device Code
A = Assembly Location
Y = Year
W = Work Week
▪ = Pb-Free Package
(Note: Microdot may be in either location)

ORDERING INFORMATION

See detailed ordering and shipping information on page 19 of this data sheet.

NCP715

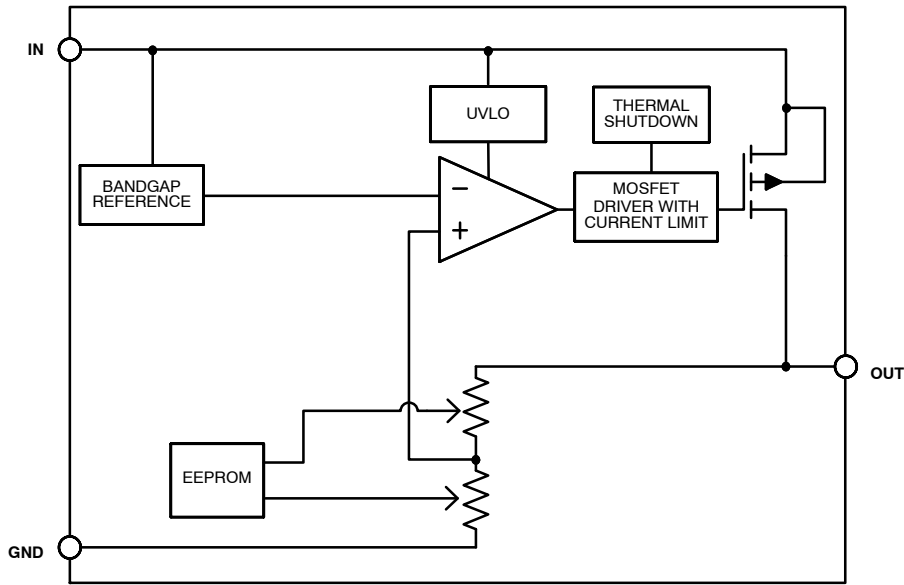

Figure 2. Simplified Block Diagram

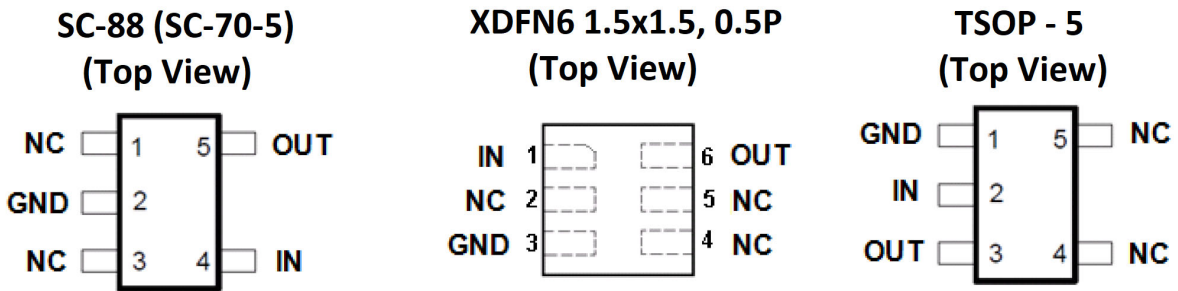

Figure 3. Pin Description

PIN FUNCTION DESCRIPTION

| Pin No. | | | Pin Name | Description |
|---------|-------|--------|----------|---|
| SC-70 | XDFN6 | TSOP-5 | | |
| 5 | 6 | 3 | OUT | Regulated output voltage pin. A small 0.47 μ F ceramic capacitor is needed from this pin to ground to assure stability. |
| 1 | 2 | 4 | N/C | No connection. This pin can be tied to ground to improve thermal dissipation or left disconnected. |
| 2 | 3 | 1 | GND | Power supply ground. |
| 3 | 4 | 5 | N/C | No connection. This pin can be tied to ground to improve thermal dissipation or left disconnected. |
| - | 5 | - | N/C | No connection. This pin can be tied to ground to improve thermal dissipation or left disconnected. |
| 4 | 1 | 2 | IN | Input pin. A small capacitor is needed from this pin to ground to assure stability. |

NCP715

ABSOLUTE MAXIMUM RATINGS

| Rating | Symbol | Value | Unit |
|---|--------------------|------------|------|
| Input Voltage (Note 1) | V_{IN} | -0.3 to 24 | V |
| Output Voltage | V_{OUT} | -0.3 to 6 | V |
| Output Short Circuit Duration | t_{SC} | Indefinite | s |
| Maximum Junction Temperature | $T_{J(MAX)}$ | 150 | °C |
| Operating Ambient Temperature Range | T_A | -40 to 125 | °C |
| Storage Temperature Range | T_{STG} | -55 to 150 | °C |
| ESD Capability, Human Body Model (Note 2) | ESD _{HBM} | 2000 | V |
| ESD Capability, Machine Model (Note 2) | ESD _{MM} | 200 | V |

Stresses exceeding those listed in the Maximum Ratings table may damage the device. If any of these limits are exceeded, device functionality should not be assumed, damage may occur and reliability may be affected.

1. Refer to ELECTRICAL CHARACTERISTICS and APPLICATION INFORMATION for Safe Operating Area.
2. This device series incorporates ESD protection and is tested by the following methods:
 - ESD Human Body Model tested per EIA/JESD22-A114
 - ESD Machine Model tested per EIA/JESD22-A115
 - ESD Charged Device Model tested per EIA/JESD22-C101E
 - Latch up Current Maximum Rating tested per JEDEC standard: JESD78.

THERMAL CHARACTERISTICS

| Rating | Symbol | Value | Unit |
|--|-----------------|-------|------|
| Thermal Characteristics, SC-70 Thermal Resistance, Junction-to-Air | $R_{\theta JA}$ | 390 | °C/W |
| Thermal Characteristics, XDFN6 Thermal Resistance, Junction-to-Air | $R_{\theta JA}$ | 260 | °C/W |
| Thermal Characteristics, TSOP-5 Thermal Resistance, Junction-to-Air | $R_{\theta JA}$ | 250 | °C/W |

NCP715

ELECTRICAL CHARACTERISTICS – Voltage Version 1.2 V

$-40^{\circ}\text{C} \leq T_J \leq 125^{\circ}\text{C}$; $V_{IN} = 2.5\text{ V}$; $I_{OUT} = 1\text{ mA}$, $C_{IN} = C_{OUT} = 1.0\ \mu\text{F}$, unless otherwise noted. Typical values are at $T_J = +25^{\circ}\text{C}$. (Note 5)

| Parameter | Test Conditions | Symbol | Min | Typ | Max | Unit | | |
|---------------------------------------|--|----------------------|---------------|-----|-------|------|---------------------|---------------|
| Operating Input Voltage | $I_{OUT} \leq 10\text{ mA}$ | V_{IN} | 2.5 | | 24 | V | | |
| | $10\text{ mA} < I_{OUT} < 50\text{ mA}$ | | 3.0 | | 24 | | | |
| Output Voltage Accuracy | $2.5\text{ V} < V_{IN} < 24\text{ V}$, $0 < I_{OUT} \leq 10\text{ mA}$ | V_{OUT} | 1.164 | 1.2 | 1.236 | V | | |
| | $3.0\text{ V} < V_{IN} < 24\text{ V}$, $0\text{ mA} < I_{OUT} < 50\text{ mA}$ | V_{OUT} | 1.164 | 1.2 | 1.236 | V | | |
| | $3.0\text{ V} < V_{IN} < 24\text{ V}$, $1\text{ mA} < I_{OUT} < 50\text{ mA}$, $-20^{\circ}\text{C} < T_J < 125^{\circ}\text{C}$; | V_{OUT} | 1.176 | 1.2 | 1.224 | V | | |
| Line Regulation | $2.5\text{ V} \leq V_{IN} \leq 24\text{ V}$, $I_{OUT} = 1\text{ mA}$ | Reg_{LINE} | | 2 | | mV | | |
| Load Regulation | $I_{OUT} = 0\text{ mA}$ to 50 mA | Reg_{LOAD} | | 5 | | mV | | |
| Dropout Voltage (Note 3) | | V_{DO} | | | - | mV | | |
| Maximum Output Current | (Note 6) | I_{OUT} | 100 | | 200 | mA | | |
| | $0 < I_{OUT} < 50\text{ mA}$, $-40 < T_A < 85^{\circ}\text{C}$ | | I_{GND} | | 3.2 | | 4.2 | μA |
| | $0 < I_{OUT} < 50\text{ mA}$, $V_{IN} = 24\text{ V}$ | | | | | | 5.8 | |
| Power Supply Rejection Ratio | $V_{IN} = 3.0\text{ V}$, $V_{OUT} = 1.2\text{ V}$ $V_{PP} = 200\text{ mV}$ modulation $I_{OUT} = 1\text{ mA}$, $C_{OUT} = 10\ \mu\text{F}$ | $f = 100\text{ kHz}$ | PSRR | | 60 | | dB | |
| Output Noise Voltage | $V_{OUT} = 1.2\text{ V}$, $I_{OUT} = 50\text{ mA}$ $f = 200\text{ Hz}$ to 100 kHz , $C_{OUT} = 10\ \mu\text{F}$ | | V_N | | 65 | | μV_{rms} | |
| Thermal Shutdown Temperature (Note 4) | Temperature increasing from $T_J = +25^{\circ}\text{C}$ | | T_{SD} | | 170 | | $^{\circ}\text{C}$ | |
| Thermal Shutdown Hysteresis (Note 4) | Temperature falling from T_{SD} | | T_{SDH} | | - | 15 | $^{\circ}\text{C}$ | |

3. Not Characterized at $V_{IN} = 3.0\text{ V}$, $V_{OUT} = 1.2\text{ V}$, $I_{OUT} = 50\text{ mA}$.

4. Guaranteed by design and characterization.

5. Performance guaranteed over the indicated operating temperature range by design and/or characterization production tested at $T_J = T_A = 25^{\circ}\text{C}$. Low duty cycle pulse techniques are used during testing to maintain the junction temperature as close to ambient as possible.

6. Respect SOA.

NCP715

ELECTRICAL CHARACTERISTICS – Voltage Version 1.5 V

$-40^{\circ}\text{C} \leq T_J \leq 125^{\circ}\text{C}$; $V_{IN} = 2.5\text{ V}$; $I_{OUT} = 1\text{ mA}$, $C_{IN} = C_{OUT} = 1.0\text{ }\mu\text{F}$, unless otherwise noted. Typical values are at $T_J = +25^{\circ}\text{C}$. (Note 9)

| Parameter | Test Conditions | Symbol | Min | Typ | Max | Unit |
|---------------------------------------|--|----------------------|-------|-----|-------|---------------------|
| Operating Input Voltage | $I_{OUT} \leq 10\text{ mA}$ | V_{IN} | 2.5 | | 24 | V |
| | $10\text{ mA} < I_{OUT} < 50\text{ mA}$ | | 3.0 | | 24 | |
| Output Voltage Accuracy | $2.5\text{ V} < V_{IN} < 24\text{ V}$, $0 < I_{OUT} \leq 10\text{ mA}$ | V_{OUT} | 1.455 | 1.5 | 1.545 | V |
| | $3.0\text{ V} < V_{IN} < 24\text{ V}$, $0 < I_{OUT} < 50\text{ mA}$ | V_{OUT} | 1.455 | 1.5 | 1.545 | V |
| | $3.0\text{ V} < V_{IN} < 24\text{ V}$, $1\text{ mA} < I_{OUT} < 50\text{ mA}$, $-20^{\circ}\text{C} < T_J < 125^{\circ}\text{C}$; | V_{OUT} | 1.470 | 1.5 | 1.530 | V |
| Line Regulation | $V_{OUT} + 1\text{ V} \leq V_{IN} \leq 24\text{ V}$, $I_{OUT} = 1\text{ mA}$ | Reg_{LINE} | | 2 | | mV |
| Load Regulation | $I_{OUT} = 0\text{ mA}$ to 50 mA | Reg_{LOAD} | | 5 | | mV |
| Dropout Voltage (Note 7) | | V_{DO} | | | - | mV |
| Maximum Output Current | (Note 10) | I_{OUT} | 100 | | 200 | mA |
| Ground Current | $0 < I_{OUT} < 50\text{ mA}$, $-40 < T_A < 85^{\circ}\text{C}$ | I_{GND} | | 3.2 | 4.2 | μA |
| | $0 < I_{OUT} < 50\text{ mA}$, $V_{IN} = 24\text{ V}$ | | | | 5.8 | μA |
| Power Supply Rejection Ratio | $V_{IN} = 3.0\text{ V}$, $V_{OUT} = 1.5\text{ V}$ $V_{PP} = 200\text{ mV}$ modulation $I_{OUT} = 1\text{ mA}$, $C_{OUT} = 10\text{ }\mu\text{F}$ | $f = 100\text{ kHz}$ | | 56 | | dB |
| Output Noise Voltage | $V_{OUT} = 1.5\text{ V}$, $I_{OUT} = 50\text{ mA}$ $f = 200\text{ Hz}$ to 100 kHz , $C_{OUT} = 10\text{ }\mu\text{F}$ | V_N | | 75 | | μV_{rms} |
| Thermal Shutdown Temperature (Note 8) | Temperature increasing from $T_J = +25^{\circ}\text{C}$ | T_{SD} | | 170 | | $^{\circ}\text{C}$ |
| Thermal Shutdown Hysteresis (Note 8) | Temperature falling from T_{SD} | T_{SDH} | - | 15 | - | $^{\circ}\text{C}$ |

7. Not Characterized at $V_{IN} = 3.0\text{ V}$, $V_{OUT} = 1.5\text{ V}$, $I_{OUT} = 50\text{ mA}$.

8. Guaranteed by design and characterization.

9. Performance guaranteed over the indicated operating temperature range by design and/or characterization production tested at

$T_J = T_A = 25^{\circ}\text{C}$. Low duty cycle pulse techniques are used during testing to maintain the junction temperature as close to ambient as possible.

10. Respect SOA.

NCP715

ELECTRICAL CHARACTERISTICS – Voltage Version 1.8 V

$-40^{\circ}\text{C} \leq T_J \leq 125^{\circ}\text{C}$; $V_{IN} = 2.8\text{V}$; $I_{OUT} = 1\text{ mA}$, $C_{IN} = C_{OUT} = 1.0\ \mu\text{F}$, unless otherwise noted. Typical values are at $T_J = +25^{\circ}\text{C}$. (Note 13)

| Parameter | Test Conditions | Symbol | Min | Typ | Max | Unit |
|--|--|----------------------|-------|-----|-------|---------------------|
| Operating Input Voltage | $I_{OUT} \leq 10\text{ mA}$ | V_{IN} | 2.8 | | 24 | V |
| | $10\text{ mA} < I_{OUT} < 50\text{ mA}$ | | 3.0 | | 24 | |
| Output Voltage Accuracy | $2.8\text{ V} < V_{IN} < 24\text{ V}$, $0 < I_{OUT} < 10\text{ mA}$ | V_{OUT} | 1.746 | 1.8 | 1.854 | V |
| | $3.0\text{ V} < V_{IN} < 24\text{ V}$, $1\text{ mA} < I_{OUT} < 50\text{ mA}$, $-20^{\circ}\text{C} < T_J < 125^{\circ}\text{C}$; | V_{OUT} | 1.764 | 1.8 | 1.836 | V |
| Line Regulation | $3\text{ V} \leq V_{IN} \leq 24\text{ V}$, $I_{OUT} = 1\text{ mA}$ | Reg_{LINE} | | 3 | | mV |
| Load Regulation | $I_{OUT} = 0\text{ mA to } 50\text{ mA}$ | Reg_{LOAD} | | 10 | | mV |
| Dropout Voltage (Note 11) | | V_{DO} | | | | mV |
| Maximum Output Current | (Note 14) | I_{OUT} | 100 | | 200 | mA |
| Ground Current | $0 < I_{OUT} < 50\text{ mA}$, $-40 < T_A < 85^{\circ}\text{C}$ | I_{GND} | | 3.2 | 4.2 | μA |
| | $0 < I_{OUT} < 50\text{ mA}$, $V_{IN} = 24\text{ V}$ | | | | 5.8 | μA |
| Power Supply Rejection Ratio | $V_{IN} = 3.0\text{ V}$, $V_{OUT} = 1.8\text{ V}$ $V_{PP} = 200\text{ mV modulation}$ $I_{OUT} = 1\text{ mA}$, $C_{OUT} = 10\ \mu\text{F}$ | $f = 100\text{ kHz}$ | | 60 | | dB |
| Output Noise Voltage | $V_{OUT} = 1.8\text{ V}$, $I_{OUT} = 50\text{ mA}$ $f = 200\text{ Hz to } 100\text{ kHz}$, $C_{OUT} = 10\ \mu\text{F}$ | V_N | | 95 | | μV_{rms} |
| Thermal Shutdown Temperature (Note 12) | Temperature increasing from $T_J = +25^{\circ}\text{C}$ | T_{SD} | | 170 | | $^{\circ}\text{C}$ |
| Thermal Shutdown Hysteresis (Note 12) | Temperature falling from T_{SD} | T_{SDH} | – | 15 | – | $^{\circ}\text{C}$ |

11. Not characterized at $V_{IN} = 3.0\text{ V}$, $V_{OUT} = 1.8\text{ V}$, $I_{OUT} = 50\text{ mA}$

12. Guaranteed by design and characterization.

13. Performance guaranteed over the indicated operating temperature range by design and/or characterization production tested at $T_J = T_A = 25^{\circ}\text{C}$. Low duty cycle pulse techniques are used during testing to maintain the junction temperature as close to ambient as possible.

14. Respect SOA.

NCP715

ELECTRICAL CHARACTERISTICS – Voltage Version 2.5 V

$-40^{\circ}\text{C} \leq T_J \leq 125^{\circ}\text{C}$; $V_{IN} = 3.5\text{ V}$; $I_{OUT} = 1\text{ mA}$, $C_{IN} = C_{OUT} = 1.0\text{ }\mu\text{F}$, unless otherwise noted. Typical values are at $T_J = +25^{\circ}\text{C}$. (Note 17)

| Parameter | Test Conditions | Symbol | Min | Typ | Max | Unit |
|--|--|----------------------|------|-----|------|---------------------|
| Operating Input Voltage | $0 < I_{OUT} < 50\text{ mA}$ | V_{IN} | 3.5 | | 24 | V |
| Output Voltage Accuracy | $3.5\text{ V} < V_{IN} < 24\text{ V}$, $0 < I_{OUT} < 50\text{ mA}$ | V_{OUT} | 2.45 | 2.5 | 2.55 | V |
| Line Regulation | $V_{OUT} + 1\text{ V} \leq V_{IN} \leq 24\text{ V}$, $I_{OUT} = 1\text{ mA}$ | Reg _{LINE} | | 3 | | mV |
| Load Regulation | $I_{OUT} = 0\text{ mA to } 50\text{ mA}$ | Reg _{LOAD} | | 10 | | mV |
| Dropout Voltage (Note 15) | $V_{DO} = V_{IN} - (V_{OUT(NOM)} - 75\text{ mV})$ $I_{OUT} = 50\text{ mA}$ | V_{DO} | | 260 | 450 | mV |
| Maximum Output Current | (Note 18) | I_{OUT} | 100 | | 200 | mA |
| Ground Current | $0 < I_{OUT} < 50\text{ mA}$, $-40 < T_A < 85^{\circ}\text{C}$ | I_{GND} | | 3.2 | 4.2 | μA |
| | $0 < I_{OUT} < 50\text{ mA}$, $V_{IN} = 24\text{ V}$ | | | | 5.8 | μA |
| Power Supply Rejection Ratio | $V_{IN} = 3.5\text{ V}$, $V_{OUT} = 2.5\text{ V}$ $V_{PP} = 200\text{ mV}$ modulation $I_{OUT} = 1\text{ mA}$, $C_{OUT} = 10\text{ }\mu\text{F}$ | $f = 100\text{ kHz}$ | PSRR | 60 | | dB |
| Output Noise Voltage | $V_{OUT} = 2.5\text{ V}$, $I_{OUT} = 50\text{ mA}$ $f = 200\text{ Hz to } 100\text{ kHz}$, $C_{OUT} = 10\text{ }\mu\text{F}$ | V_N | | 115 | | μV_{rms} |
| Thermal Shutdown Temperature (Note 16) | Temperature increasing from $T_J = +25^{\circ}\text{C}$ | T_{SD} | | 170 | | $^{\circ}\text{C}$ |
| Thermal Shutdown Hysteresis (Note 16) | Temperature falling from T_{SD} | T_{SDH} | – | 15 | – | $^{\circ}\text{C}$ |

15. Characterized when V_{OUT} falls 75 mV below the regulated voltage and only for devices with $V_{OUT} = 2.5\text{ V}$.

16. Guaranteed by design and characterization.

17. Performance guaranteed over the indicated operating temperature range by design and/or characterization production tested at

$T_J = T_A = 25^{\circ}\text{C}$. Low duty cycle pulse techniques are used during testing to maintain the junction temperature as close to ambient as possible.

18. Respect SOA.

NCP715

ELECTRICAL CHARACTERISTICS – Voltage Version 3.0 V

$-40^{\circ}\text{C} \leq T_J \leq 125^{\circ}\text{C}$; $V_{IN} = 4.0\text{ V}$; $I_{OUT} = 1\text{ mA}$, $C_{IN} = C_{OUT} = 1.0\ \mu\text{F}$, unless otherwise noted. Typical values are at $T_J = +25^{\circ}\text{C}$. (Note 21)

| Parameter | Test Conditions | Symbol | Min | Typ | Max | Unit |
|--|--|----------------------|------|-----|------|---------------------|
| Operating Input Voltage | $0 < I_{OUT} < 50\text{ mA}$ | V_{IN} | 4.0 | | 24 | V |
| Output Voltage Accuracy | $4.0\text{ V} < V_{IN} < 24\text{ V}$, $0 < I_{OUT} < 50\text{ mA}$ | V_{OUT} | 2.94 | 3.0 | 3.06 | V |
| Line Regulation | $V_{OUT} + 1\text{ V} \leq V_{IN} \leq 24\text{ V}$, $I_{OUT} = 1\text{ mA}$ | Reg_{LINE} | | 3 | | mV |
| Load Regulation | $I_{OUT} = 0\text{ mA}$ to 50 mA | Reg_{LOAD} | | 10 | | mV |
| Dropout voltage (Note 19) | $V_{DO} = V_{IN} - (V_{OUT(NOM)} - 90\text{ mV})$ $I_{OUT} = 50\text{ mA}$ | V_{DO} | | 250 | 400 | mV |
| Maximum Output Current | (Note 22) | I_{OUT} | 100 | | 200 | mA |
| Ground current | $0 < I_{OUT} < 50\text{ mA}$, $-40 < T_A < 85^{\circ}\text{C}$ | I_{GND} | | 3.2 | 4.2 | μA |
| | $0 < I_{OUT} < 50\text{ mA}$, $V_{IN} = 24\text{ V}$ | | | | 5.8 | μA |
| Power Supply Rejection Ratio | $V_{IN} = 4.0\text{ V}$, $V_{OUT} = 3.0\text{ V}$ $V_{PP} = 100\text{ mV}$ modulation $I_{OUT} = 1\text{ mA}$, $C_{OUT} = 10\ \mu\text{F}$ | $f = 100\text{ kHz}$ | | 60 | | dB |
| Output Noise Voltage | $V_{OUT} = 3\text{ V}$, $I_{OUT} = 50\text{ mA}$, $f = 200\text{ Hz}$ to 100 kHz , $C_{OUT} = 10\ \mu\text{F}$ | V_N | | 135 | | μV_{rms} |
| Thermal Shutdown Temperature (Note 20) | Temperature increasing from $T_J = +25^{\circ}\text{C}$ | T_{SD} | | 170 | | $^{\circ}\text{C}$ |
| Thermal Shutdown Hysteresis (Note 20) | Temperature falling from T_{SD} | T_{SDH} | - | 25 | - | $^{\circ}\text{C}$ |

19. Characterized when V_{OUT} falls 90 mV below the regulated voltage and only for devices with $V_{OUT} = 3.0\text{ V}$

20. Guaranteed by design and characterization.

21. Performance guaranteed over the indicated operating temperature range by design and/or characterization production tested

at $T_J = T_A = 25^{\circ}\text{C}$. Low duty cycle pulse techniques are used during testing to maintain the junction temperature as close to ambient as possible.

22. Respect SOA

NCP715

ELECTRICAL CHARACTERISTICS – Voltage Version 3.3 V

$-40^{\circ}\text{C} \leq T_J \leq 125^{\circ}\text{C}$; $V_{IN} = 4.3\text{ V}$; $I_{OUT} = 1\text{ mA}$, $C_{IN} = C_{OUT} = 1.0\text{ }\mu\text{F}$, unless otherwise noted. Typical values are at $T_J = +25^{\circ}\text{C}$. (Note 25)

| Parameter | Test Conditions | Symbol | Min | Typ | Max | Unit | |
|--|--|----------------------|-------|-----|-------|---------------------|----|
| Operating Input Voltage | $0 < I_{OUT} < 50\text{ mA}$ | V_{IN} | 4.3 | | 24 | V | |
| Output Voltage Accuracy | $4.3\text{ V} < V_{IN} < 24\text{ V}$, $0 < I_{OUT} < 50\text{ mA}$ | V_{OUT} | 3.234 | 3.3 | 3.366 | V | |
| Line Regulation | $V_{OUT} + 1\text{ V} \leq V_{IN} \leq 24\text{ V}$, $I_{OUT} = 1\text{ mA}$ | Reg _{LINE} | | 3 | 10 | mV | |
| Load Regulation | $I_{OUT} = 0\text{ mA}$ to 50 mA | Reg _{LOAD} | | 10 | | mV | |
| Dropout Voltage (Note 23) | $V_{DO} = V_{IN} - (V_{OUT(NOM)} - 99\text{ mV})$ $I_{OUT} = 50\text{ mA}$ | V_{DO} | | 230 | 350 | mV | |
| Maximum Output Current | (Note 26) | I_{OUT} | 100 | | 200 | mA | |
| Ground Current | $0 < I_{OUT} < 50\text{ mA}$, $-40 < T_A < 85^{\circ}\text{C}$ | I_{GND} | | 3.2 | 4.2 | μA | |
| | $0 < I_{OUT} < 50\text{ mA}$, $V_{IN} = 24\text{ V}$ | | | | 5.8 | μA | |
| Power Supply Rejection Ratio | $V_{IN} = 4.3\text{ V}$, $V_{OUT} = 3.3\text{ V}$ $V_{PP} = 200\text{ mV}$ modulation $I_{OUT} = 1\text{ mA}$, $C_{OUT} = 10\text{ }\mu\text{F}$ | $f = 100\text{ kHz}$ | PSRR | | 60 | | dB |
| Output Noise Voltage | $V_{OUT} = 4.3\text{ V}$, $I_{OUT} = 50\text{ mA}$ $f = 200\text{ Hz}$ to 100 kHz , $C_{OUT} = 10\text{ }\mu\text{F}$ | V_N | | 140 | | μV_{rms} | |
| Thermal Shutdown Temperature (Note 24) | Temperature increasing from $T_J = +25^{\circ}\text{C}$ | T_{SD} | | 170 | | $^{\circ}\text{C}$ | |
| Thermal Shutdown Hysteresis (Note 24) | Temperature falling from T_{SD} | T_{SDH} | – | 15 | – | $^{\circ}\text{C}$ | |

23. Characterized when V_{OUT} falls 99 mV below the regulated voltage and only for devices with $V_{OUT} = 3.3\text{ V}$.

24. Guaranteed by design and characterization.

25. Performance guaranteed over the indicated operating temperature range by design and/or characterization production tested at $T_J = T_A = 25^{\circ}\text{C}$. Low duty cycle pulse techniques are used during testing to maintain the junction temperature as close to ambient as possible.

26. Respect SOA.

NCP715

ELECTRICAL CHARACTERISTICS – Voltage Version 5.0 V

$-40^{\circ}\text{C} \leq T_J \leq 125^{\circ}\text{C}$; $V_{IN} = 6.0\text{ V}$; $I_{OUT} = 1\text{ mA}$, $C_{IN} = C_{OUT} = 1\text{ }\mu\text{F}$, unless otherwise noted. Typical values are at $T_J = +25^{\circ}\text{C}$. (Note 29)

| Parameter | Test Conditions | Symbol | Min | Typ | Max | Unit |
|--|--|----------------------|-----|-----|-----|---------------------|
| Operating Input Voltage | $0 < I_{OUT} < 50\text{ mA}$ | V_{IN} | 6.0 | | 24 | V |
| Output Voltage Accuracy | $6.0\text{V} < V_{IN} < 24\text{V}$, $0 < I_{OUT} < 50\text{ mA}$ | V_{OUT} | 4.9 | 5.0 | 5.1 | V |
| Line Regulation | $V_{OUT} + 1\text{ V} \leq V_{IN} \leq 24\text{ V}$, $I_{OUT} = 1\text{ mA}$ | Reg_{LINE} | | 3 | 10 | mV |
| Load Regulation | $I_{OUT} = 0\text{ mA}$ to 50 mA | Reg_{LOAD} | | 10 | 30 | mV |
| Dropout Voltage (Note 27) | $V_{DO} = V_{IN} - (V_{OUT(NOM)} - 150\text{ mV})$ $I_{OUT} = 50\text{ mA}$ | V_{DO} | | 230 | 350 | mV |
| Maximum Output Current | (Note 30) | I_{OUT} | 90 | | 200 | mA |
| Ground Current | $0 < I_{OUT} < 50\text{ mA}$, $-40 < T_A < 85^{\circ}\text{C}$ | I_{GND} | | 3.2 | 4.2 | μA |
| | $0 < I_{OUT} < 50\text{ mA}$, $V_{IN} = 24\text{ V}$ | | | | 5.8 | μA |
| Power Supply Rejection Ratio | $V_{IN} = 6.0\text{ V}$, $V_{OUT} = 5.0\text{ V}$ $V_{PP} = 200\text{ mV}$ modulation $I_{OUT} = 1\text{ mA}$, $C_{OUT} = 10\text{ }\mu\text{F}$ | $f = 100\text{ kHz}$ | | 56 | | dB |
| Output Noise Voltage | $V_{OUT} = 5.0\text{ V}$, $I_{OUT} = 50\text{ mA}$ $f = 200\text{ Hz}$ to 100 kHz , $C_{OUT} = 10\text{ }\mu\text{F}$ | V_N | | 190 | | μV_{rms} |
| Thermal Shutdown Temperature (Note 28) | Temperature increasing from $T_J = +25^{\circ}\text{C}$ | T_{SD} | | 170 | | $^{\circ}\text{C}$ |
| Thermal Shutdown Hysteresis (Note 28) | Temperature falling from T_{SD} | T_{SDH} | – | 15 | – | $^{\circ}\text{C}$ |

27. Characterized when V_{OUT} falls 150 mV below the regulated voltage and only for devices with $V_{OUT} = 5.0\text{ V}$.

28. Guaranteed by design and characterization.

29. Performance guaranteed over the indicated operating temperature range by design and/or characterization production tested at $T_J = T_A = 25^{\circ}\text{C}$. Low duty cycle pulse techniques are used during testing to maintain the junction temperature as close to ambient as possible.

30. Respect SOA.

NCP715

ELECTRICAL CHARACTERISTICS – Voltage Version 5.3 V

–40°C ≤ T_J ≤ 125°C; V_{IN} = 6.3 V; I_{OUT} = 1 mA, C_{IN} = C_{OUT} = 1 μF, unless otherwise noted. Typical values are at T_J = +25°C. (Note 33)

| Parameter | Test Conditions | Symbol | Min | Typ | Max | Unit |
|--|---|---------------------|-------|-----|-------|-------------------|
| Operating Input Voltage | 0 < I _{OUT} < 50 mA | V _{IN} | 6.3 | | 24 | V |
| Output Voltage Accuracy | 6.3V < V _{IN} < 24V, 0.1 mA < I _{OUT} < 50 mA | V _{OUT} | 5.194 | 5.3 | 5.406 | V |
| Line Regulation | V _{OUT} + 1 V ≤ V _{IN} ≤ 24 V, I _{OUT} = 1mA | Reg _{LINE} | | 20 | 60 | mV |
| Load Regulation | I _{OUT} = 0.1 mA to 50 mA | Reg _{LOAD} | | 20 | | mV |
| Dropout Voltage (Note 31) | V _{DO} = V _{IN} – (V _{OUT(NOM)} – 159 mV) I _{OUT} = 50 mA | V _{DO} | | 230 | 350 | mV |
| Maximum Output Current | (Note 34) | I _{OUT} | 90 | | 200 | mA |
| Ground Current | 0 < I _{OUT} < 50 mA, –40 < T _A < 85°C | I _{GND} | | 3.2 | 4.2 | μA |
| | 0 < I _{OUT} < 50 mA, V _{IN} = 24 V | | | | 5.8 | μA |
| Power Supply Rejection Ratio | V _{IN} = 6.3 V, V _{OUT} = 5.3 V V _{PP} = 200 mV modulation I _{OUT} = 1 mA, C _{OUT} = 10 μF | f = 100 kHz | PSRR | 55 | | dB |
| Output Noise Voltage | V _{OUT} = 5.3 V, I _{OUT} = 50 mA f = 200 Hz to 100 kHz, C _{OUT} = 10 μF | V _N | | 195 | | μV _{rms} |
| Thermal Shutdown Temperature (Note 32) | Temperature increasing from T _J = +25°C | T _{SD} | | 170 | | °C |
| Thermal Shutdown Hysteresis (Note 32) | Temperature falling from T _{SD} | T _{SDH} | – | 15 | – | °C |

31. Characterized when V_{OUT} falls 159 mV below the regulated voltage and only for devices with V_{OUT} = 5.3 V.

32. Guaranteed by design and characterization.

33. Performance guaranteed over the indicated operating temperature range by design and/or characterization production tested at T_J = T_A = 25°C. Low duty cycle pulse techniques are used during testing to maintain the junction temperature as close to ambient as possible.

34. Respect SOA.

NCP715

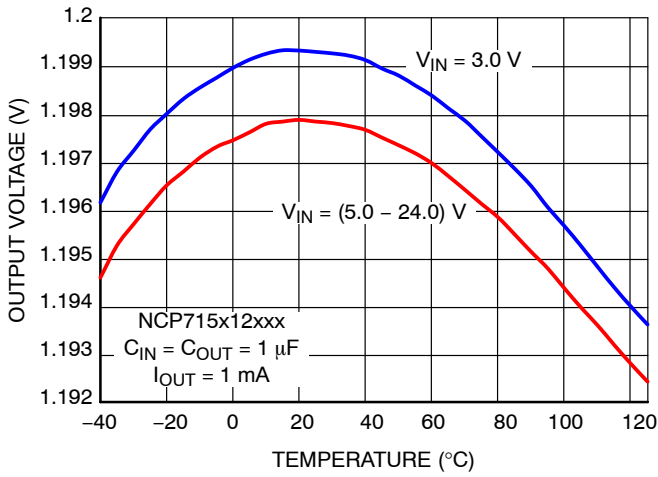

Figure 4. Output Voltage vs. Temperature

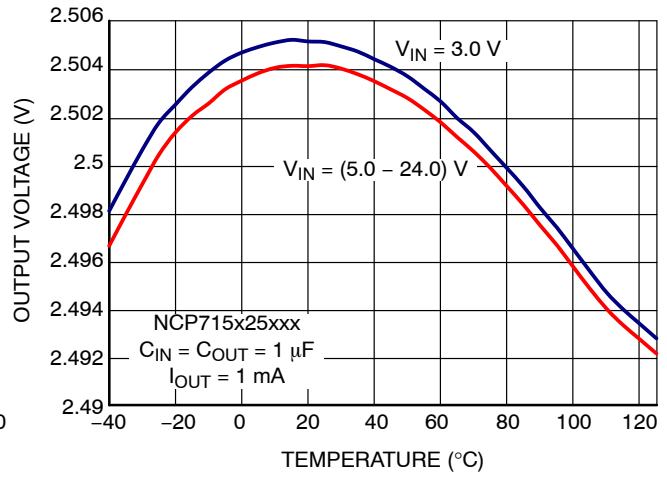

Figure 5. Output Voltage vs. Temperature

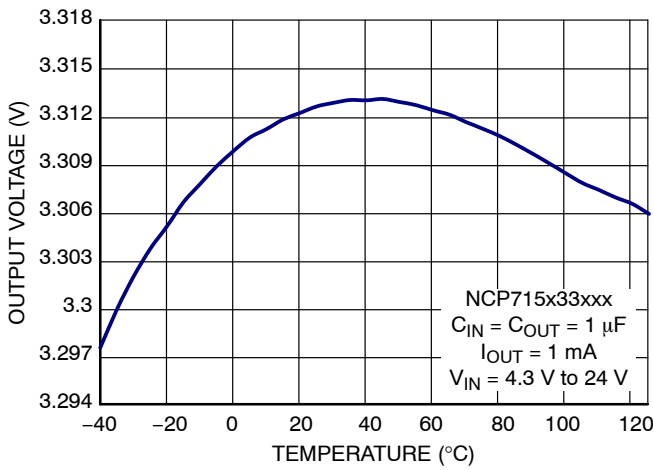

Figure 6. Output Voltage vs. Temperature

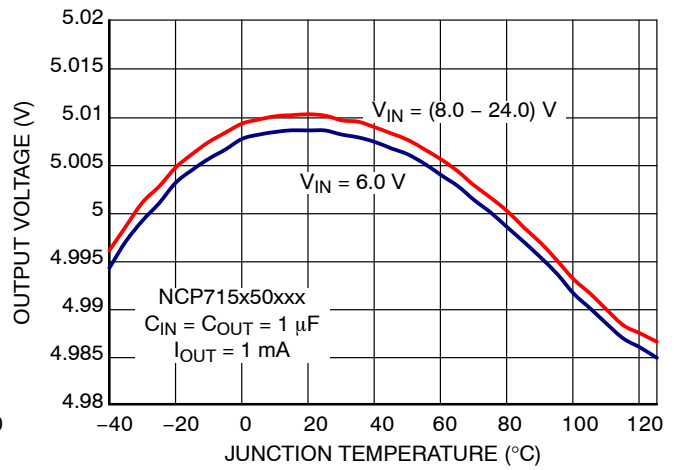

Figure 7. Output Voltage vs. Temperature

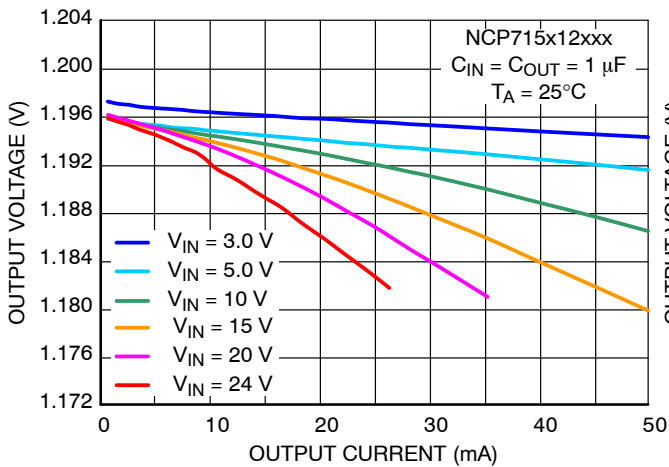

Figure 8. Output Voltage vs. Output Current

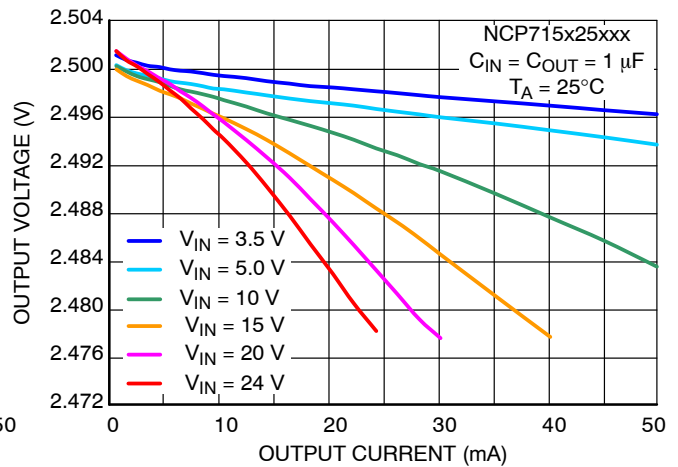

Figure 9. Output Voltage vs. Output Current

NCP715

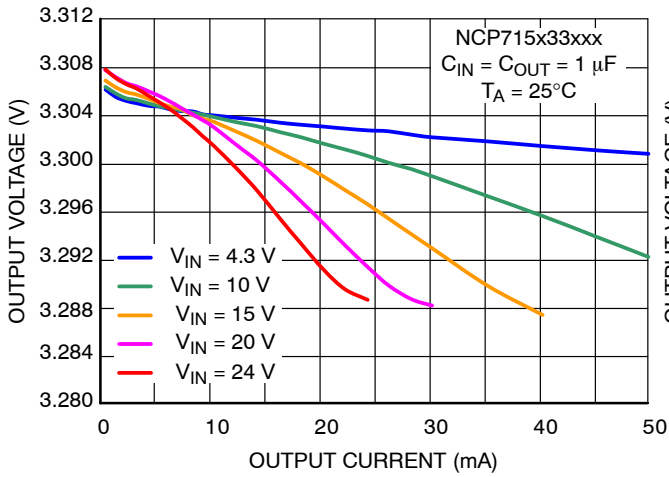

Figure 10. Output Voltage vs. Output Current

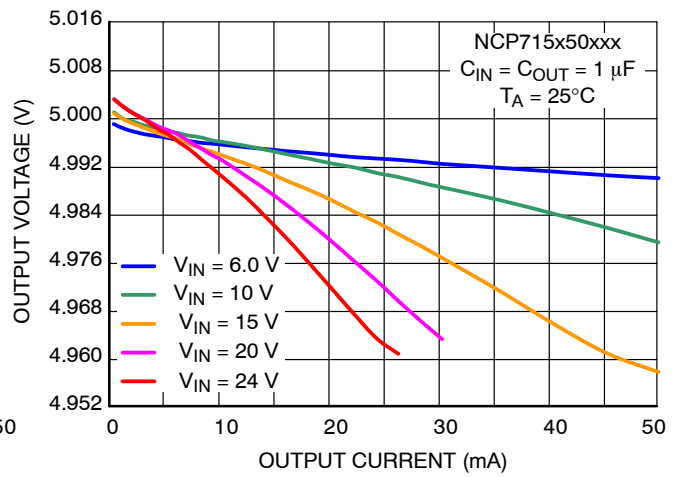

Figure 11. Output Voltage vs. Output Current

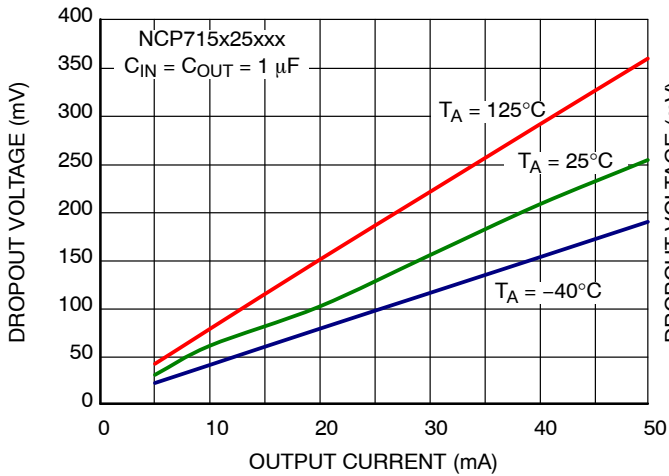

Figure 12. Dropout Voltage vs. Output Current

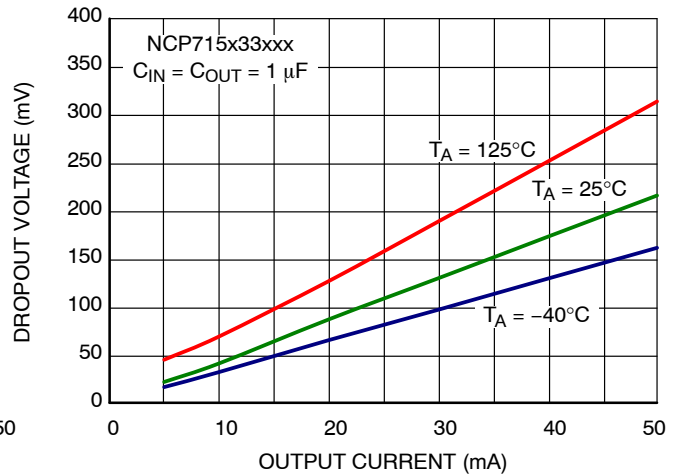

Figure 13. Dropout Voltage vs. Output Current

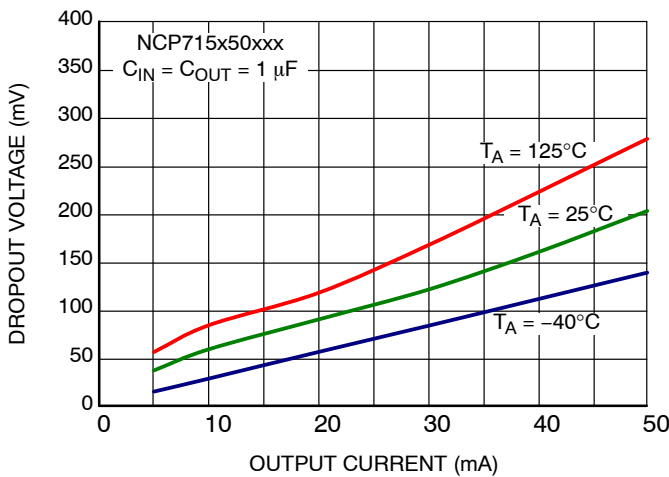

Figure 14. Dropout Voltage vs. Output Current

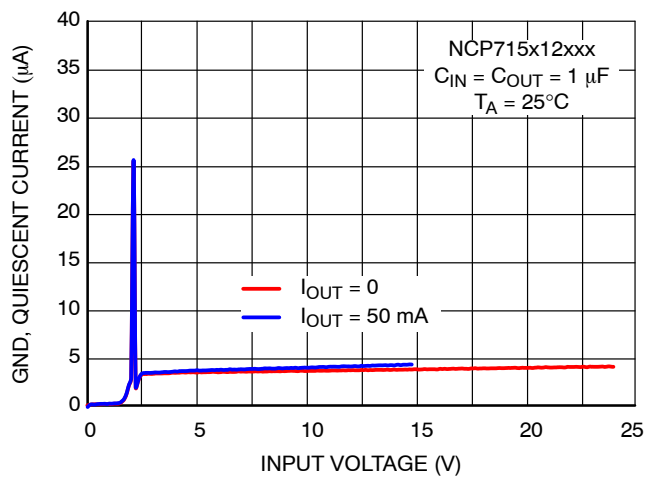

Figure 15. Ground Current vs. Input Voltage

NCP715

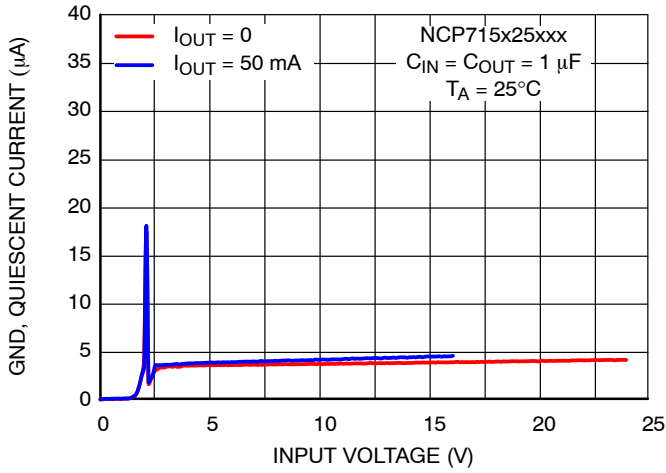

Figure 16. Ground Current vs. Input Voltage

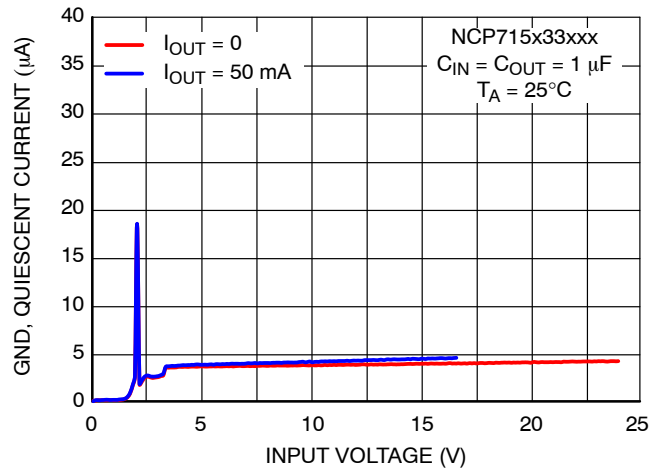

Figure 17. Ground Current vs. Input Voltage

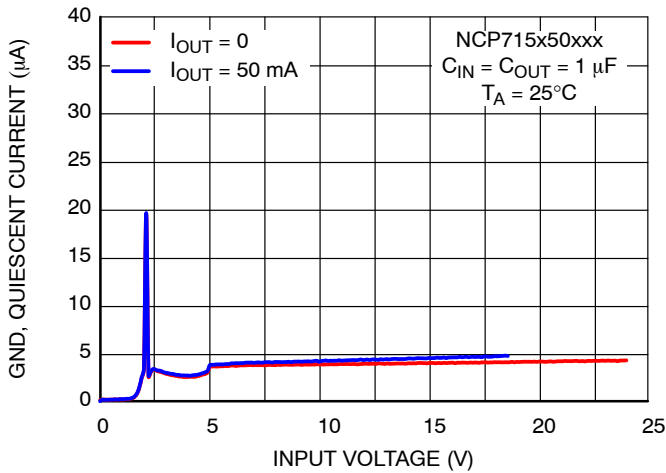

Figure 18. Ground Current vs. Input Voltage

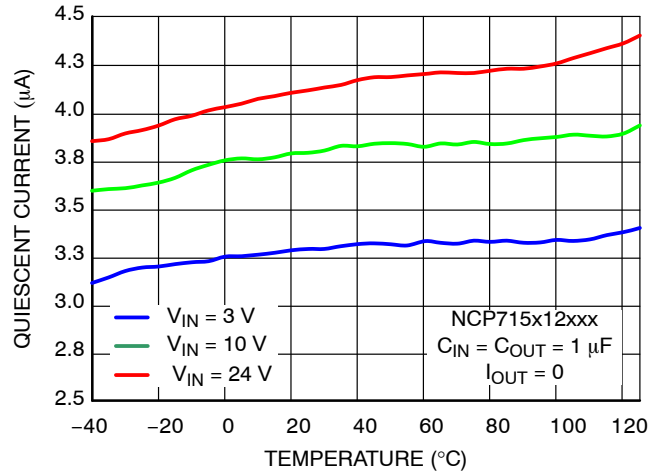

Figure 19. Quiescent Current vs. Temperature

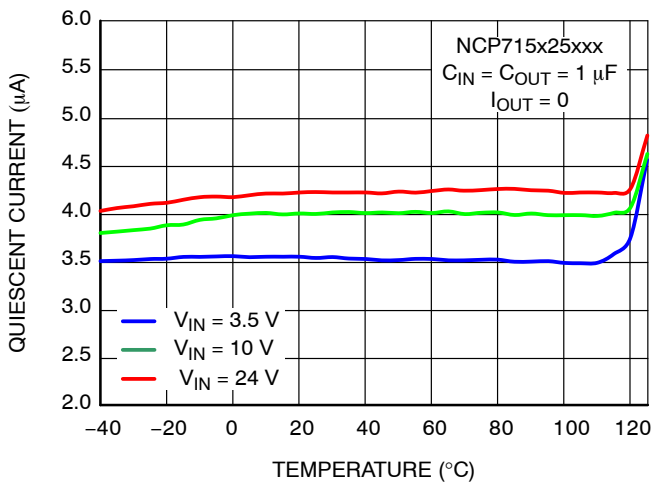

Figure 20. Quiescent Current vs. Temperature

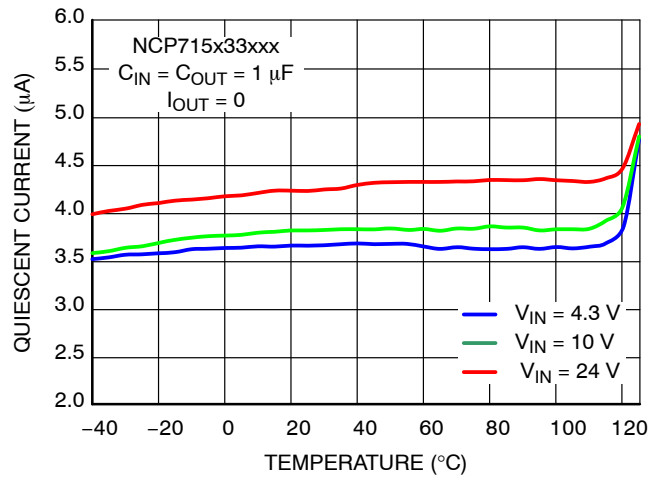

Figure 21. Quiescent Current vs. Temperature

NCP715

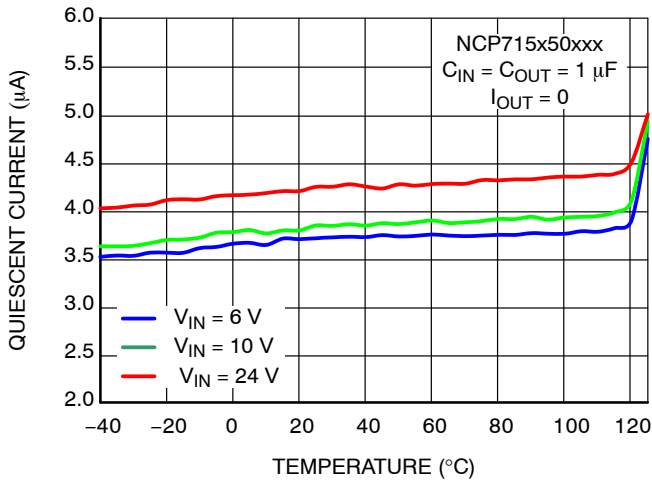

Figure 22. Quiescent Current vs. Temperature

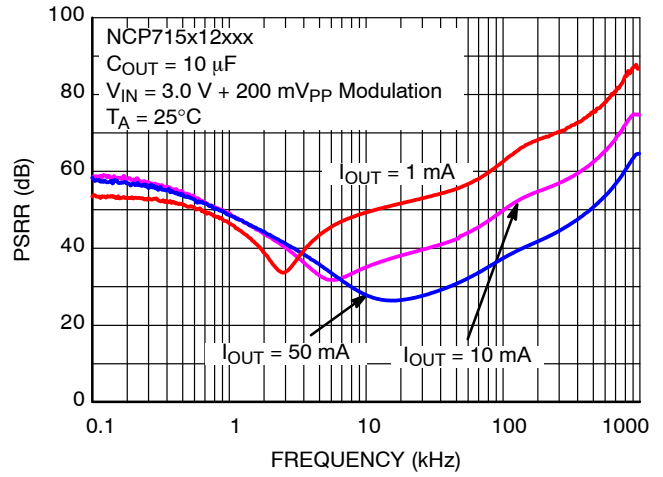

Figure 23. PSRR vs. Frequency

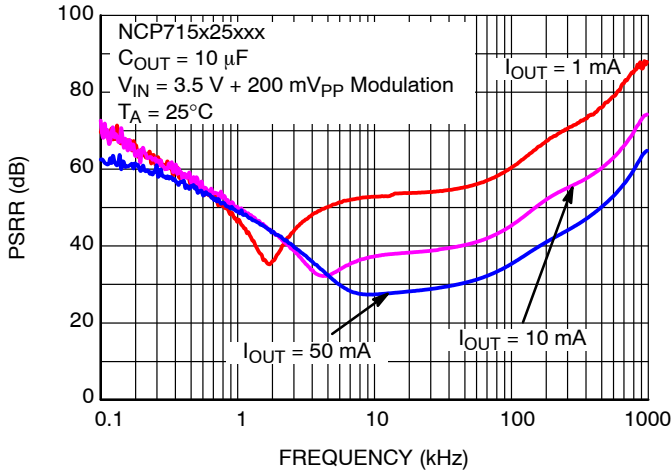

Figure 24. PSRR vs. Frequency

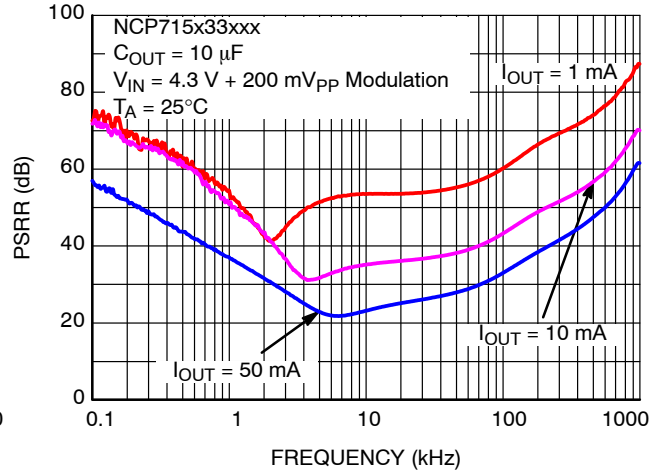

Figure 25. PSRR vs. Frequency

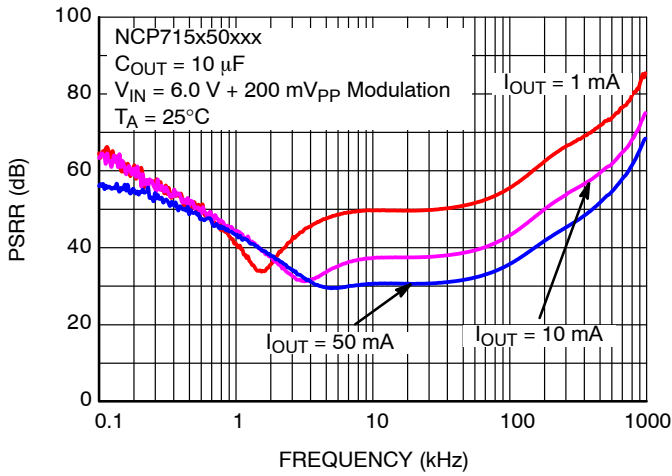

Figure 26. PSRR vs. Frequency

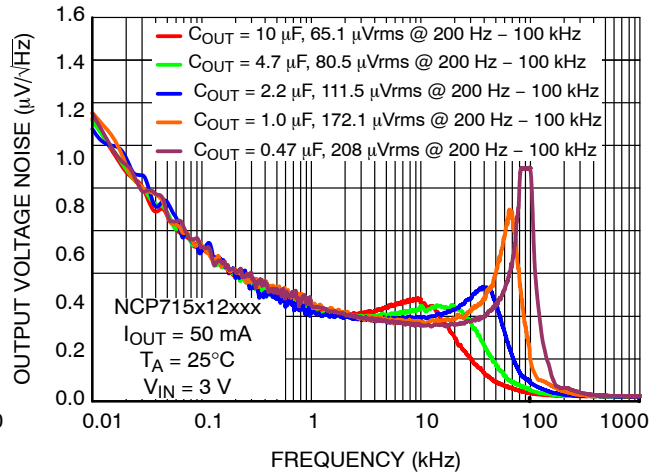

Figure 27. Output Spectral Noise Density vs. Frequency

NCP715

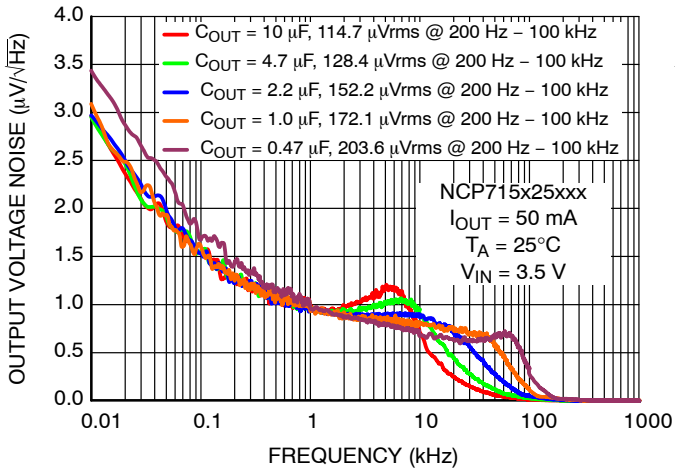

Figure 28. Output Spectral Noise Density vs. Frequency

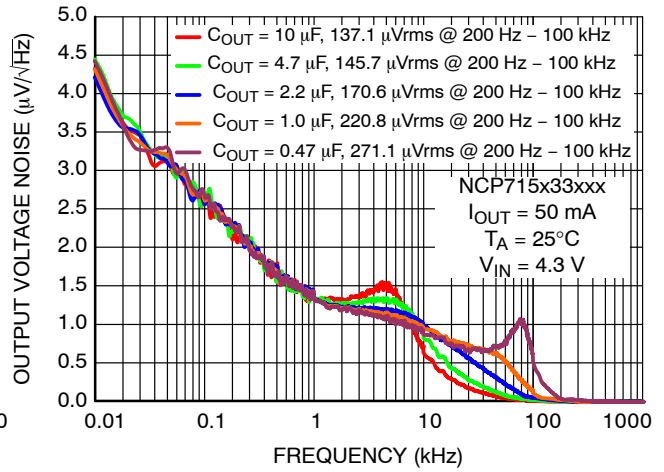

Figure 29. Output Spectral Noise Density vs. Frequency

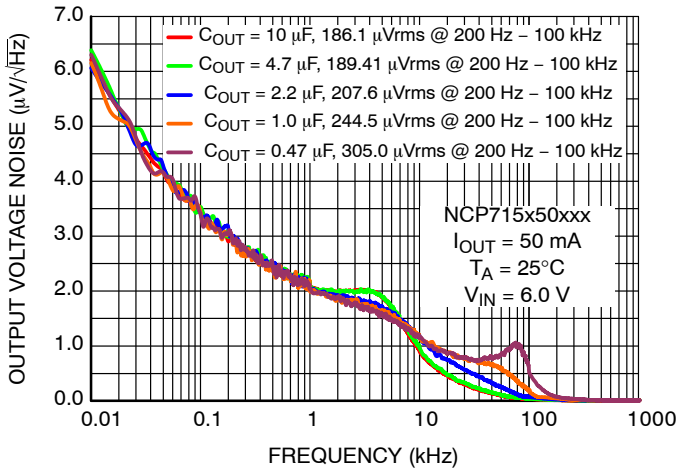

Figure 30. Output Spectral Noise Density vs. Frequency

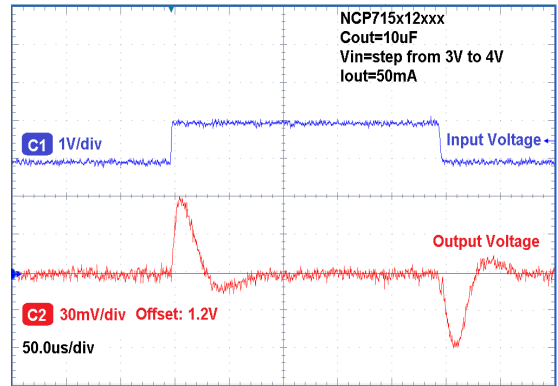

Figure 31. Line Transient Response

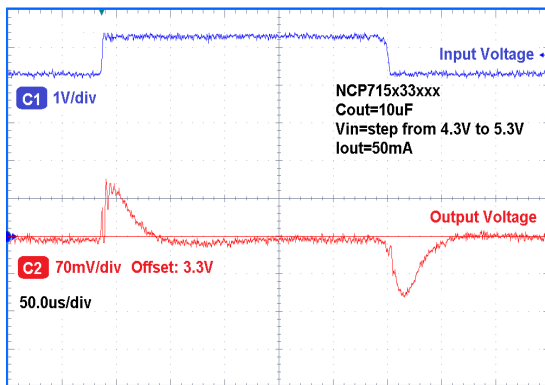

Figure 32. Line Transient Response

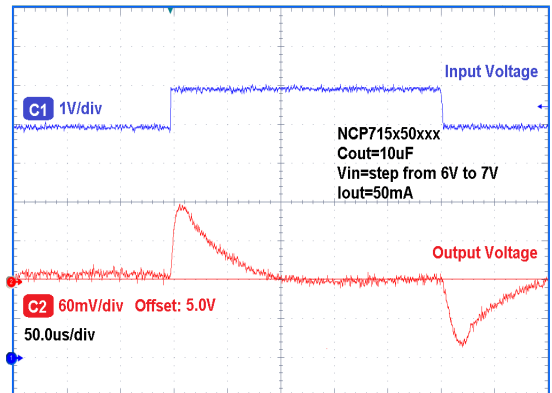

Figure 33. Line Transient Response

NCP715

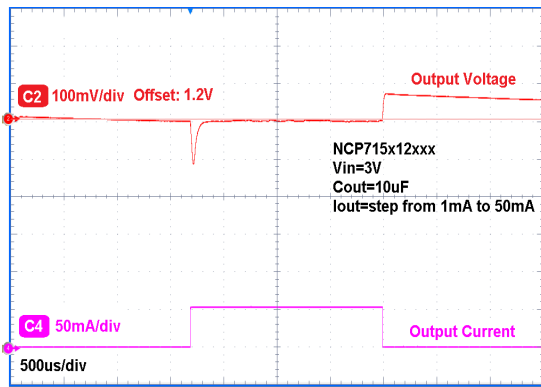

Figure 34. Load Transient Response

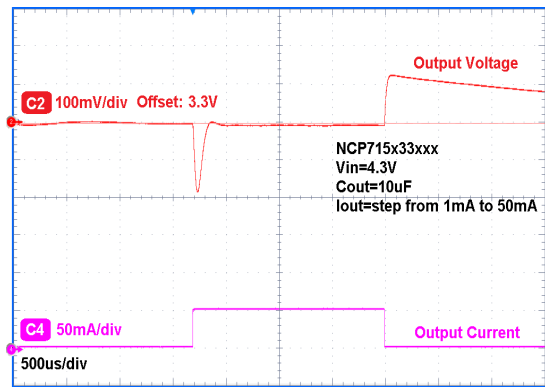

Figure 35. Load Transient Response

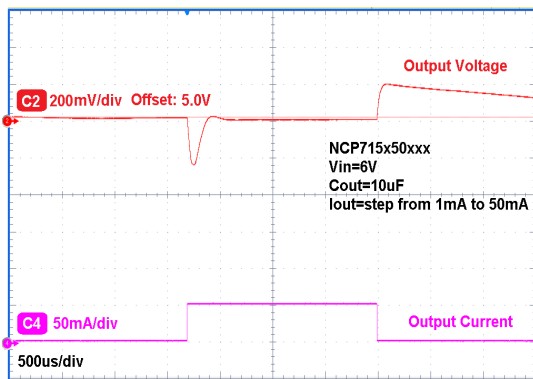

Figure 36. Load Transient Response

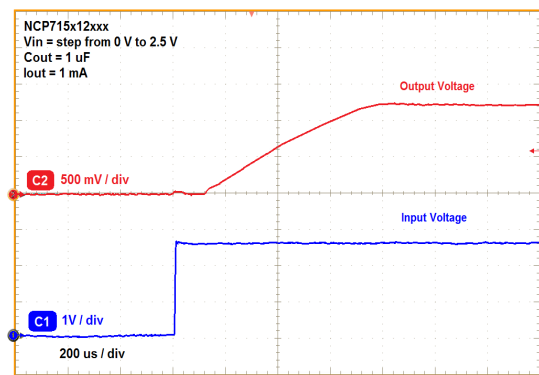

Figure 37. Input Voltage Turn-On Response

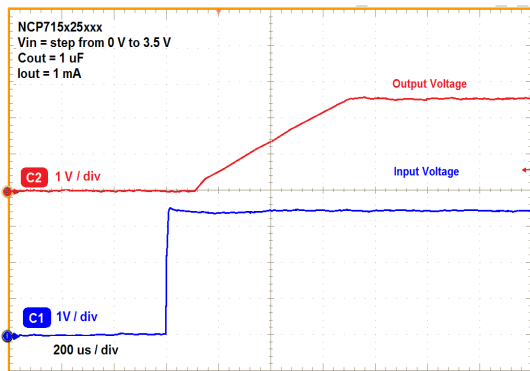

Figure 38. Input Voltage Turn-On Response

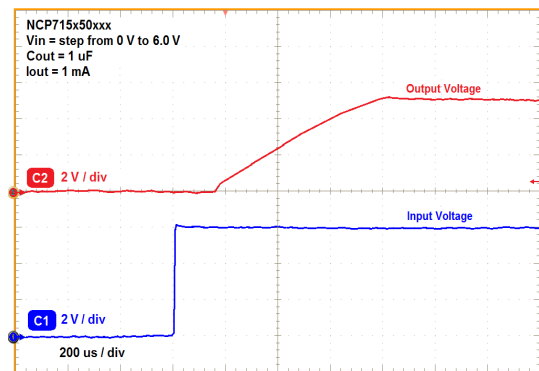

Figure 39. Input Voltage Turn-On Response

APPLICATIONS INFORMATION

The NCP715 is the member of new family of Wide Input Voltage Range Low Dropout Regulators which delivers Ultra Low Ground Current consumption, Good Noise and Power Supply Rejection Ratio Performance.

Input Decoupling (C_{IN})

It is recommended to connect at least 0.1 μ F Ceramic X5R or X7R capacitor between IN and GND pin of the device. This capacitor will provide a low impedance path for any unwanted AC signals or Noise superimposed onto constant Input Voltage. The good input capacitor will limit the influence of input trace inductances and source resistance during sudden load current changes.

Higher capacitance and lower ESR Capacitors will improve the overall line transient response.

Output Decoupling (C_{OUT})

The NCP715 does not require a minimum Equivalent Series Resistance (ESR) for the output capacitor. The device is designed to be stable with standard ceramics capacitors with values of 0.47 μ F or greater up to 10 μ F. The X5R and X7R types have the lowest capacitance variations over temperature thus they are recommended.

Power Dissipation and Heat sinking

The maximum power dissipation supported by the device is dependent upon board design and layout. Mounting pad configuration on the PCB, the board material, and the

ambient temperature affect the rate of junction temperature rise for the part. The maximum power dissipation the NCP715 can handle is given by:

$$P_{D(MAX)} = \frac{[T_{J(MAX)} - T_A]}{R_{\theta JA}} \quad (\text{eq. 1})$$

The power dissipated by the NCP715 for given application conditions can be calculated from the following equations:

$$P_D \approx V_{IN}(I_{GND}(I_{OUT})) + I_{OUT}(V_{IN} - V_{OUT}) \quad (\text{eq. 2})$$

or

$$V_{IN(MAX)} \approx \frac{P_{D(MAX)} + (V_{OUT} \times I_{OUT})}{I_{OUT} + I_{GND}} \quad (\text{eq. 3})$$

For reliable operation, junction temperature should be limited to +125°C maximum.

Hints

V_{IN} and GND printed circuit board traces should be as wide as possible. When the impedance of these traces is high, there is a chance to pick up noise or cause the regulator to malfunction. Place external components, especially the output capacitor, as close as possible to the NCP715, and make traces as short as possible.

NCP715

ORDERING INFORMATION

| Device | Nominal Output Voltage | Marking | Marking Rotation | Package | Shipping† |
|-------------------------|------------------------|---------|------------------|------------------------------|--|
| NCP715SQ12T2G | 1.2 V | 5A | - | SC88A/SC70 (Pb-Free) | 3000 or 5000 / Tape & Reel (Note 35) |
| NCP715SQ15T2G | 1.5 V | 5C | | | |
| NCP715SQ18T2G | 1.8 V | 5D | | | |
| NCP715SQ25T2G | 2.5 V | 5E | | | |
| NCP715SQ30T2G | 3.0 V | 5F | | | |
| NCP715SQ33T2G | 3.3 V | 5G | | | |
| NCP715SQ50T2G | 5.0 V | 5H | | | |
| NCP715MX12TBG | 1.2 V | Q | 0° | XDFN6 1.5 x 1.5 (Pb-Free) | |
| NCP715MX15TBG (Note 35) | 1.5 V | R | | | |
| NCP715MX18TBG (Note 35) | 1.8 V | T | | | |
| NCP715MX25TBG (Note 35) | 2.5 V | V | | | |
| NCP715MX30TBG (Note 35) | 3.0 V | Y | | | |
| NCP715MX33TBG (Note 35) | 3.3 V | 2 | | | |
| NCP715MX50TBG (Note 35) | 5.0 V | 5 | | | |
| NCP715MX53TBG (Note 35) | 5.3 V | 5 | +180° | | |
| NCP715SN12T1G | 1.2 V | PZD | - | TSOP-5 (Pb-Free) | 3000 / Tape & Reel |
| NCP715SN15T1G | 1.5 V | PZE | - | | |
| NCP715SN18T1G | 1.8 V | PZF | - | | |
| NCP715SN25T1G | 2.5 V | PZG | - | | |
| NCP715SN30T1G | 3.0 V | PZH | - | | |
| NCP715SN33T1G | 3.3 V | PZJ | - | | |
| NCP715SN50T1G | 5.0 V | PZK | - | | |

†For information on tape and reel specifications, including part orientation and tape sizes, please refer to our Tape and Reel Packaging Specifications Brochure, BRD8011/D.

35. Products processed after October 1, 2022 are shipped with quantity 5000 units / tape & reel.



SCALE 2:1

SC-88A (SC-70-5/SOT-353)
CASE 419A-02
ISSUE M

DATE 11 APR 2023

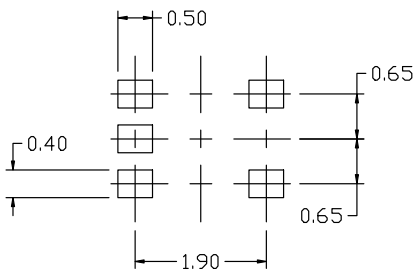
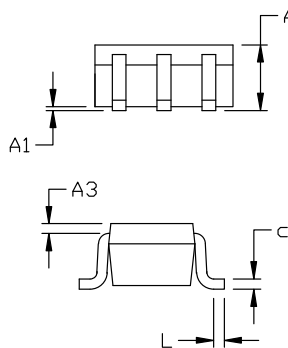

RECOMMENDED MOUNTING FOOTPRINT

* For additional information on our Pb-Free strategy and soldering details, please download the ON Semiconductor Soldering and Mounting Techniques Reference Manual, SOLDERM/D.

NOTES:

1. DIMENSIONING AND TOLERANCING PER ANSI Y14.5M, 1982.
2. CONTROLLING DIMENSION: MILLIMETERS
3. 419A-01 OBSOLETE. NEW STANDARD 419A-02
4. DIMENSIONS D AND E1 DO NOT INCLUDE MOLD FLASH, PROTRUSIONS, OR GATE BURRS. MOLD FLASH, PROTRUSIONS, OR GATE BURRS SHALL NOT EXCEED 0.1016MM PER SIDE.

| DIM | MILLIMETERS | | |
|-----|-------------|------|------|
| | MIN. | NOM. | MAX. |
| A | 0.80 | 0.95 | 1.10 |
| A1 | --- | --- | 0.10 |
| A3 | 0.20 REF | | |
| b | 0.10 | 0.20 | 0.30 |
| c | 0.10 | --- | 0.25 |
| D | 1.80 | 2.00 | 2.20 |
| E | 2.00 | 2.10 | 2.20 |
| E1 | 1.15 | 1.25 | 1.35 |
| e | 0.65 BSC | | |
| L | 0.10 | 0.15 | 0.30 |

GENERIC MARKING DIAGRAM*

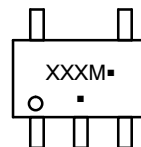

*This information is generic. Please refer to device data sheet for actual part marking. Pb-Free indicator, "G" or microdot "▪", may or may not be present. Some products may not follow the Generic Marking.

XXX = Specific Device Code
M = Date Code
▪ = Pb-Free Package

(Note: Microdot may be in either location)

STYLE 1:

- PIN 1. BASE
- 2. EMITTER
- 3. BASE
- 4. COLLECTOR
- 5. COLLECTOR

STYLE 2:

- PIN 1. ANODE
- 2. EMITTER
- 3. BASE
- 4. COLLECTOR
- 5. CATHODE

STYLE 3:

- PIN 1. ANODE 1
- 2. N/C
- 3. ANODE 2
- 4. CATHODE 2
- 5. CATHODE 1

STYLE 4:

- PIN 1. SOURCE 1
- 2. DRAIN 1/2
- 3. SOURCE 1
- 4. GATE 1
- 5. GATE 2

STYLE 5:

- PIN 1. CATHODE
- 2. COMMON ANODE
- 3. CATHODE 2
- 4. CATHODE 3
- 5. CATHODE 4

STYLE 6:

- PIN 1. EMITTER 2
- 2. BASE 2
- 3. EMITTER 1
- 4. COLLECTOR
- 5. COLLECTOR 2/BASE 1

STYLE 7:

- PIN 1. BASE
- 2. EMITTER
- 3. BASE
- 4. COLLECTOR
- 5. COLLECTOR

STYLE 8:

- PIN 1. CATHODE
- 2. COLLECTOR
- 3. N/C
- 4. BASE
- 5. EMITTER

STYLE 9:

- PIN 1. ANODE
- 2. CATHODE
- 3. ANODE
- 4. ANODE
- 5. ANODE

Note: Please refer to datasheet for style callout. If style type is not called out in the datasheet refer to the device datasheet pinout or pin assignment.

| | | |
|------------------|--------------------------|--|
| DOCUMENT NUMBER: | 98ASB42984B | Electronic versions are uncontrolled except when accessed directly from the Document Repository. Printed versions are uncontrolled except when stamped "CONTROLLED COPY" in red. |
| DESCRIPTION: | SC-88A (SC-70-5/SOT-353) | PAGE 1 OF 1 |

onsemi and onsemi are trademarks of Semiconductor Components Industries, LLC dba onsemi or its subsidiaries in the United States and/or other countries. onsemi reserves the right to make changes without further notice to any products herein. onsemi makes no warranty, representation or guarantee regarding the suitability of its products for any particular purpose, nor does onsemi assume any liability arising out of the application or use of any product or circuit, and specifically disclaims any and all liability, including without limitation special, consequential or incidental damages. onsemi does not convey any license under its patent rights nor the rights of others.

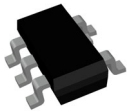

TSOP-5 3.00x1.50x0.95, 0.95P
CASE 483
ISSUE P

DATE 01 APR 2024

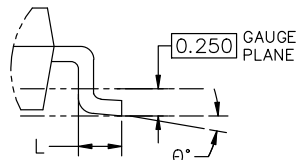
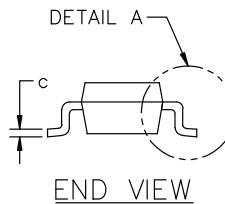
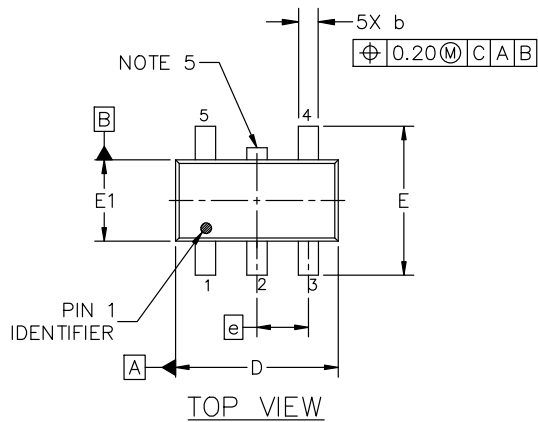

DETAIL "A"
SCALE 2:1

GENERIC
MARKING DIAGRAM*



- XXX = Specific Device Code
- A = Assembly Location
- Y = Year
- W = Work Week
- = Pb-Free Package

(Note: Microdot may be in either location)

*This information is generic. Please refer to device data sheet for actual part marking. Pb-Free indicator, "G" or microdot "▪", may or may not be present. Some products may not follow the Generic Marking.

NOTES:

1. DIMENSIONING AND TOLERANCING CONFORM TO ASME Y14.5-2018.
2. ALL DIMENSION ARE IN MILLIMETERS (ANGLES IN DEGREES).
3. MAXIMUM LEAD THICKNESS INCLUDES LEAD FINISH THICKNESS. MINIMUM LEAD THICKNESS IS THE MINIMUM THICKNESS OF BASE MATERIAL.
4. DIMENSIONS D AND E1 DO NOT INCLUDE MOLD FLASH, PROTRUSIONS OF GATE BURRS. MOLD FLASH, PROTRUSIONS, OR GATE BURRS SHALL NOT EXCEED 0.15 PER SIDE. DIMENSION D.
5. OPTIONAL CONSTRUCTION: AN ADDITIONAL TRIMMED LEAD IS ALLOWED IN THIS LOCATION. TRIMMED LEAD NOT TO EXTEND MORE THAN 0.2 FROM BODY.

| DIM | MILLIMETERS | | |
|-----|-------------|-------|-------|
| | MIN. | NOM. | MAX. |
| A | 0.900 | 1.000 | 1.100 |
| A1 | 0.010 | 0.055 | 0.100 |
| A2 | 0.950 REF. | | |
| b | 0.250 | 0.375 | 0.500 |
| c | 0.100 | 0.180 | 0.260 |
| D | 2.850 | 3.000 | 3.150 |
| E | 2.500 | 2.750 | 3.000 |
| E1 | 1.350 | 1.500 | 1.650 |
| e | 0.950 BSC | | |
| L | 0.200 | 0.400 | 0.600 |
| θ | 0° | 5° | 10° |

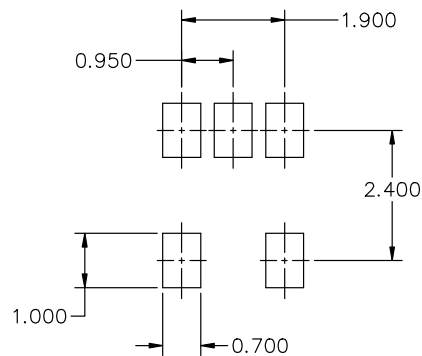

RECOMMENDED MOUNTING FOOTPRINT*

* FOR ADDITIONAL INFORMATION ON OUR Pb-FREE STRATEGY AND SOLDERING DETAILS, PLEASE DOWNLOAD THE ON SEMICONDUCTOR SOLDERING AND MOUNTING TECHNIQUES REFERENCE MANUAL, SOLDERM/D.

| | | |
|------------------|------------------------------|--|
| DOCUMENT NUMBER: | 98ARB18753C | Electronic versions are uncontrolled except when accessed directly from the Document Repository. Printed versions are uncontrolled except when stamped "CONTROLLED COPY" in red. |
| DESCRIPTION: | TSOP-5 3.00x1.50x0.95, 0.95P | PAGE 1 OF 1 |

onsemi and onsemi are trademarks of Semiconductor Components Industries, LLC dba onsemi or its subsidiaries in the United States and/or other countries. onsemi reserves the right to make changes without further notice to any products herein. onsemi makes no warranty, representation or guarantee regarding the suitability of its products for any particular purpose, nor does onsemi assume any liability arising out of the application or use of any product or circuit, and specifically disclaims any and all liability, including without limitation special, consequential or incidental damages. onsemi does not convey any license under its patent rights nor the rights of others.



SCALE 4:1

XDFN6 1.5x1.5, 0.5P
CASE 711AE
ISSUE B

DATE 27 AUG 2015

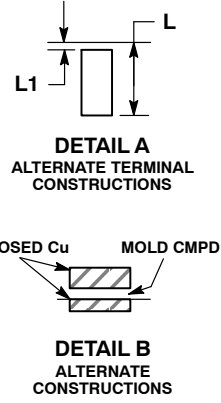
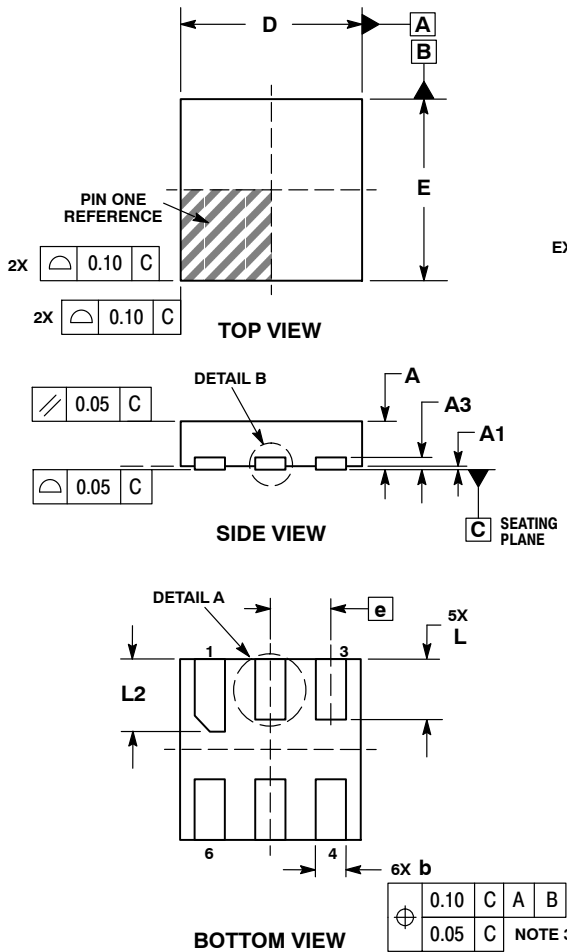

- NOTES:
1. DIMENSIONING AND TOLERANCING PER ASME Y14.5M, 1994.
 2. CONTROLLING DIMENSION: MILLIMETERS.
 3. DIMENSION b APPLIES TO PLATED TERMINAL AND IS MEASURED BETWEEN 0.10 AND 0.20mm FROM TERMINAL TIP.

| DIM | MILLIMETERS | |
|-----|-------------|------|
| | MIN | MAX |
| A | 0.35 | 0.45 |
| A1 | 0.00 | 0.05 |
| A3 | 0.13 REF | |
| b | 0.20 | 0.30 |
| D | 1.50 BSC | |
| E | 1.50 BSC | |
| e | 0.50 BSC | |
| L | 0.40 | 0.60 |
| L1 | --- | 0.15 |
| L2 | 0.50 | 0.70 |

GENERIC MARKING DIAGRAM*

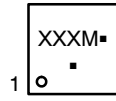

- XXX = Specific Device Code
- M = Date Code
- o = Pb-Free Package

(Note: Microdot may be in either location)

*This information is generic. Please refer to device data sheet for actual part marking. Pb-Free indicator, "G" or microdot "o", may or may not be present.

RECOMMENDED MOUNTING FOOTPRINT*

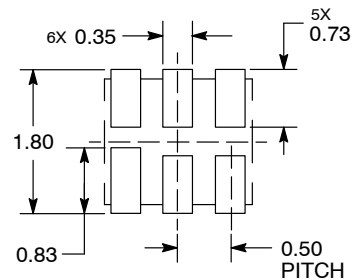

DIMENSIONS: MILLIMETERS

*For additional information on our Pb-Free strategy and soldering details, please download the **onsemi Soldering and Mounting Techniques Reference Manual**, [SOLDERRM/D](#).

| | | |
|-------------------------|--------------------------------|--|
| DOCUMENT NUMBER: | 98AON56376E | Electronic versions are uncontrolled except when accessed directly from the Document Repository. Printed versions are uncontrolled except when stamped "CONTROLLED COPY" in red. |
| DESCRIPTION: | XDFN6, 1.5 X 1.5, 0.5 P | PAGE 1 OF 1 |

onsemi and ONSEMI are trademarks of Semiconductor Components Industries, LLC dba onsemi or its subsidiaries in the United States and/or other countries. onsemi reserves the right to make changes without further notice to any products herein. onsemi makes no warranty, representation or guarantee regarding the suitability of its products for any particular purpose, nor does onsemi assume any liability arising out of the application or use of any product or circuit, and specifically disclaims any and all liability, including without limitation special, consequential or incidental damages. onsemi does not convey any license under its patent rights nor the rights of others.

onsemi, **Onsemi**, and other names, marks, and brands are registered and/or common law trademarks of Semiconductor Components Industries, LLC dba "**onsemi**" or its affiliates and/or subsidiaries in the United States and/or other countries. **onsemi** owns the rights to a number of patents, trademarks, copyrights, trade secrets, and other intellectual property. A listing of **onsemi**'s product/patent coverage may be accessed at www.onsemi.com/site/pdf/Patent-Marking.pdf. **onsemi** reserves the right to make changes at any time to any products or information herein, without notice. The information herein is provided "as-is" and **onsemi** makes no warranty, representation or guarantee regarding the accuracy of the information, product features, availability, functionality, or suitability of its products for any particular purpose, nor does **onsemi** assume any liability arising out of the application or use of any product or circuit, and specifically disclaims any and all liability, including without limitation special, consequential or incidental damages. Buyer is responsible for its products and applications using **onsemi** products, including compliance with all laws, regulations and safety requirements or standards, regardless of any support or applications information provided by **onsemi**. "Typical" parameters which may be provided in **onsemi** data sheets and/or specifications can and do vary in different applications and actual performance may vary over time. All operating parameters, including "Typicals" must be validated for each customer application by customer's technical experts. **onsemi** does not convey any license under any of its intellectual property rights nor the rights of others. **onsemi** products are not designed, intended, or authorized for use as a critical component in life support systems or any FDA Class 3 medical devices or medical devices with a same or similar classification in a foreign jurisdiction or any devices intended for implantation in the human body. Should Buyer purchase or use **onsemi** products for any such unintended or unauthorized application, Buyer shall indemnify and hold **onsemi** and its officers, employees, subsidiaries, affiliates, and distributors harmless against all claims, costs, damages, and expenses, and reasonable attorney fees arising out of, directly or indirectly, any claim of personal injury or death associated with such unintended or unauthorized use, even if such claim alleges that **onsemi** was negligent regarding the design or manufacture of the part. **onsemi** is an Equal Opportunity/Affirmative Action Employer. This literature is subject to all applicable copyright laws and is not for resale in any manner.

ADDITIONAL INFORMATION

TECHNICAL PUBLICATIONS:

Technical Library: www.onsemi.com/design/resources/technical-documentation
onsemi Website: www.onsemi.com

ONLINE SUPPORT: www.onsemi.com/support

For additional information, please contact your local Sales Representative at www.onsemi.com/support/sales