

NCV4276, NCV4276A

400 mA Low-Drop Voltage Regulator

The NCV4276 is a 400 mA output current integrated low dropout regulator family designed for use in harsh automotive environments. It includes wide operating temperature and input voltage ranges. The device is offered with fixed output voltage options of 1.8 V and 2.5 V with 4% output voltage accuracy while the 3.3 V, 5.0 V, and adjustable voltage versions are available either in 2% or 4% output voltage accuracy. It has a high peak input voltage tolerance and reverse input voltage protection. It also provides overcurrent protection, overtemperature protection and inhibit for control of the state of the output voltage. The NCV4276 family is available in DPAK and D²PAK surface mount packages. The output is stable over a wide output capacitance and ESR range.

Features

- 2.5 V and 1.8 V $\pm 4\%$ Output Voltage
- 3.3 V, 5.0 V, and Adjustable Voltage Version (from 2.5 V to 20 V) $\pm 4\%$ or $\pm 2\%$ Output Voltage
- 400 mA Output Current
- 500 mV (max) Dropout Voltage (5.0 V Output)
- Inhibit Input
- Very Low Current Consumption
- Fault Protection
 - ◆ +45 V Peak Transient Voltage
 - ◆ -42 V Reverse Voltage
 - ◆ Short Circuit
 - ◆ Thermal Overload
- NCV Prefix for Automotive and Other Applications Requiring Site and Control Changes
- These are Pb-Free Devices



ON Semiconductor®

<http://onsemi.com>

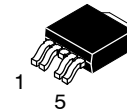

**DPAK
5-PIN
DT SUFFIX
CASE 175AA**

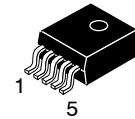

**D²PAK
5-PIN
DS SUFFIX
CASE 936A**

DEVICE MARKING INFORMATION

See general marking information in the device marking section on page 22 of this data sheet.

ORDERING INFORMATION

See detailed ordering and shipping information in the ordering information section on page 23 of this data sheet.

NCV4276, NCV4276A

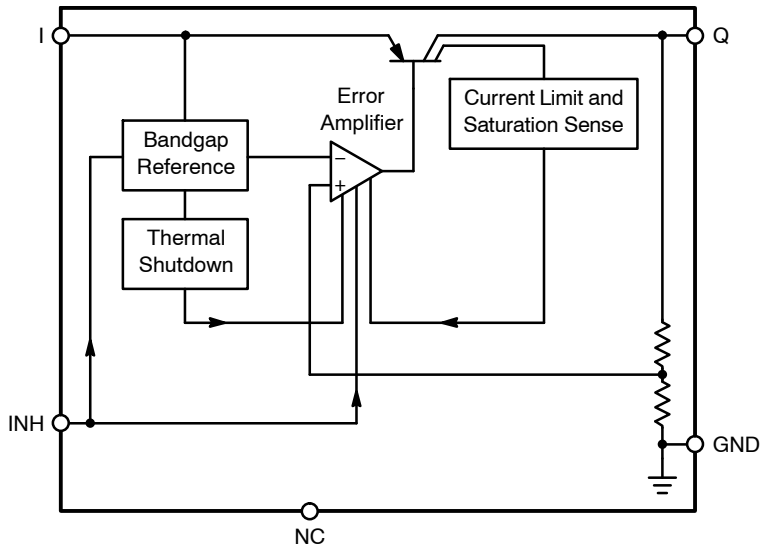

Figure 1. 4276 Block Diagram

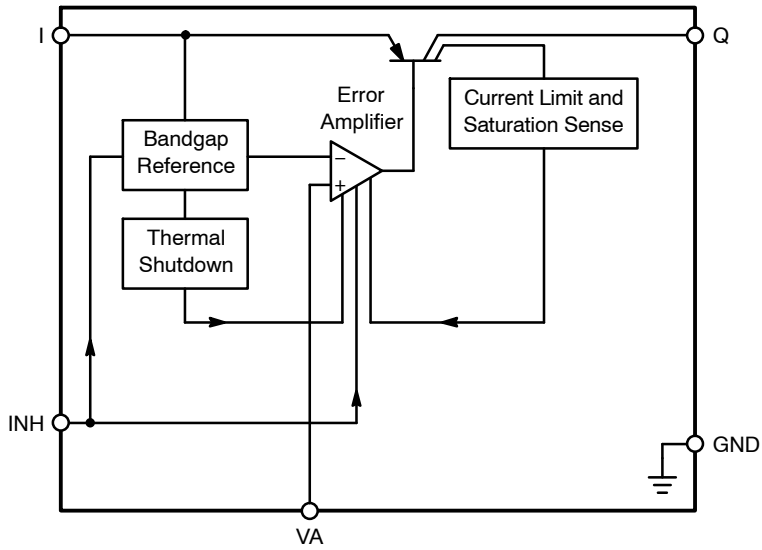

Figure 2. 4276 Adjustable Block Diagram

NCV4276, NCV4276A

PIN FUNCTION DESCRIPTION

Pin No.	Symbol	Description
1	I	Input; Battery Supply Input Voltage.
2	INH	Inhibit; Set low-to inhibit.
3	GND	Ground; Pin 3 internally connected to heatsink.
4	NC / VA	Not connected for fixed voltage version / Voltage Adjust Input for adjustable voltage version; use an external voltage divider to set the output voltage
5	Q	Output: Bypass with a capacitor to GND. See Figures 3 to 8 and Regulator Stability Considerations section.

MAXIMUM RATINGS*

Rating	Symbol	Min	Max	Unit
Input Voltage	V_I	-42	45	V
Input Peak Transient Voltage	V_I	-	45	V
Inhibit INH Voltage	V_{INH}	-42	45	V
Voltage Adjust Input VA	V_{VA}	-0.3	10	V
Output Voltage	V_Q	-1.0	40	V
Ground Current	I_q	-	100	mA
Input Voltage Operating Range	V_I	$V_Q + 0.5 \text{ V}$ or 4.5 V (Note 1)	40	V
ESD Susceptibility	(Human Body Model)	-	4.5	kV
	(Machine Model)	-	250	V
	(Charged Device Model)	-	1.25	kV
Junction Temperature	T_J	-40	150	°C
Storage Temperature	T_{stg}	-50	150	°C

Stresses exceeding Maximum Ratings may damage the device. Maximum Ratings are stress ratings only. Functional operation above the Recommended Operating Conditions is not implied. Extended exposure to stresses above the Recommended Operating Conditions may affect device reliability.

*During the voltage range which exceeds the maximum tested voltage of I, operation is assured, but not specified. Wider limits may apply. Thermal dissipation must be observed closely.

LEAD TEMPERATURE SOLDERING REFLOW (Note 2)

Lead Temperature Soldering	T_{SLD}			°C
Reflow (SMD styles only), Leaded, 60–150 s above 183, 30 s max at peak		-	240	
Reflow (SMD styles only), Lead Free, 60–150 s above 217, 40 s max at peak		-	265	
Wave Solder (through hole styles only), 12 sec max		-	310	

THERMAL CHARACTERISTICS

Characteristic	Test Conditions (Typical Value)	Unit
----------------	---------------------------------	------

DPAK 5-PIN PACKAGE

	Min Pad Board (Note 3)	1" Pad Board (Note 4)	
Junction-to-Tab (ψ_{JLX} , ψ_{JLX})	4.2	4.7	C/W
Junction-to-Ambient ($R_{\theta JA}$, θ_{JA})	100.9	46.8	C/W

D²PAK 5-PIN PACKAGE

	0.4 sq. in. Spreader Board (Note 5)	1.2 sq. in. Spreader Board (Note 6)	
Junction-to-Tab (ψ_{JLX} , ψ_{JLX})	3.8	4.0	C/W
Junction-to-Ambient ($R_{\theta JA}$, θ_{JA})	74.8	41.6	C/W

1. Minimum $V_I = 4.5 \text{ V}$ or ($V_Q + 0.5 \text{ V}$), whichever is higher.
2. Per IPC / JEDEC J-STD-020C.
3. 1 oz. copper, 0.26 inch² (168 mm²) copper area, 0.062" thick FR4.
4. 1 oz. copper, 1.14 inch² (736 mm²) copper area, 0.062" thick FR4.
5. 1 oz. copper, 0.373 inch² (241 mm²) copper area, 0.062" thick FR4.
6. 1 oz. copper, 1.222 inch² (788 mm²) copper area, 0.062" thick FR4.

NCV4276, NCV4276A

ELECTRICAL CHARACTERISTICS ($V_I = 13.5\text{ V}$; $-40^\circ\text{C} < T_J < 150^\circ\text{C}$; unless otherwise noted.)

Characteristic	Symbol	Test Conditions	NCV4276			NCV4276A			Unit
			Min	Typ	Max	Min	Typ	Max	
OUTPUT									
Output Voltage, 5.0 V Version	V_Q	$5.0\text{ mA} < I_Q < 400\text{ mA}$, $6.0\text{ V} < V_I < 28\text{ V}$	4.8	5.0	5.2	4.9	5.0	5.1	V
Output Voltage, 5.0 V Version	V_Q	$5.0\text{ mA} < I_Q < 200\text{ mA}$, $6.0\text{ V} < V_I < 40\text{ V}$	4.8	5.0	5.2	4.9	5.0	5.1	V
Output Voltage, 3.3 V Version	V_Q	$5.0\text{ mA} < I_Q < 400\text{ mA}$, $4.5\text{ V} < V_I < 28\text{ V}$	3.168	3.3	3.432	3.234	3.3	3.366	V
Output Voltage, 3.3 V Version	V_Q	$5.0\text{ mA} < I_Q < 200\text{ mA}$, $4.5\text{ V} < V_I < 40\text{ V}$	3.168	3.3	3.432	3.234	3.3	3.366	V
Output Voltage, 2.5 V Version	V_Q	$5.0\text{ mA} < I_Q < 400\text{ mA}$, $4.5\text{ V} < V_I < 28\text{ V}$	2.4	2.5	2.6	–	–	–	V
Output Voltage, 2.5 V Version	V_Q	$5.0\text{ mA} < I_Q < 200\text{ mA}$, $4.5\text{ V} < V_I < 40\text{ V}$	2.4	2.5	2.6	–	–	–	V
Output Voltage, 1.8 V Version	V_Q	$5.0\text{ mA} < I_Q < 400\text{ mA}$, $4.5\text{ V} < V_I < 28\text{ V}$	1.728	1.8	1.872	–	–	–	V
Output Voltage, 1.8 V Version	V_Q	$5.0\text{ mA} < I_Q < 200\text{ mA}$, $4.5\text{ V} < V_I < 40\text{ V}$	1.728	1.8	1.872	–	–	–	V
Output Voltage, Adjustable Version	AV_Q	$5.0\text{ mA} < I_Q < 400\text{ mA}$ $V_{Q+1} < V_I < 40\text{ V}$ $V_I > 4.5\text{ V}$	–4%	–	+4%	–2%	–	+2%	V
Output Current Limitation	I_Q	$V_Q = 90\% V_{Q\text{TYP}}$ ($V_{Q\text{TYP}} = 2.5\text{ V}$ for ADJ version)	400	700	1100	400	700	1100	mA
Quiescent Current (Sleep Mode) $I_q = I_I - I_Q$	I_q	$V_{\text{INH}} = 0\text{ V}$	–	–	10	–	–	10	μA
Quiescent Current, $I_q = I_I - I_Q$	I_q	$I_Q = 1.0\text{ mA}$	–	130	220	–	130	200	μA
Quiescent Current, $I_q = I_I - I_Q$	I_q	$I_Q = 250\text{ mA}$	–	10	15	–	10	15	mA
Quiescent Current, $I_q = I_I - I_Q$	I_q	$I_Q = 400\text{ mA}$	–	25	35	–	25	35	mA
Dropout Voltage, 5.0 V Version 3.3 V Version 2.5 V Version 1.8 V Version Adjustable Version	V_{DR}	$I_Q = 250\text{ mA}$, $V_{\text{DR}} = V_I - V_Q$ $V_I = 5.0\text{ V}$ $V_I = 4.5\text{ V}$ $V_I = 4.5\text{ V}$ $V_I = 4.5\text{ V}$ $V_I > 4.5\text{ V}$	–	250	500	–	–	–	mV V V V mV
Dropout Voltage (5.0 V Version)	V_{DR}	$I_Q = 250\text{ mA}$ (Note 7)	–	–	–	–	250	500	mV
Load Regulation	$\Delta V_{Q,\text{LO}}$	$I_Q = 5.0\text{ mA}$ to 400 mA	–	10	35	–	3.0	20	mV
Line Regulation	ΔV_Q	$\Delta V_I = 12\text{ V}$ to 32 V , $I_Q = 5.0\text{ mA}$	–	2.5	25	–	4.0	15	mV
Power Supply Ripple Rejection	PSRR	$f_r = 100\text{ Hz}$, $V_r = 0.5\text{ V}_{\text{PP}}$	–	60	–	–	70	–	dB
Temperature Output Voltage Drift	dV_Q/dT	–	–	0.5	–	–	0.5	–	mV/K

INHIBIT

Inhibit Voltage, Output High	V_{INH}	$V_Q \geq V_{Q\text{MIN}}$	–	2.8	3.5	–	2.3	2.8	V
Inhibit Voltage, Output Low (Off)	V_{INH}	$V_Q \leq 0.1\text{ V}$	0.5	1.7	–	1.8	2.2	–	V
Input Current	I_{INH}	$V_{\text{INH}} = 5.0\text{ V}$	5.0	10	20	5.0	10	20	μA

THERMAL SHUTDOWN

Thermal Shutdown Temperature*	T_{SD}	$I_Q = 5.0\text{ mA}$	150	–	210	150	–	210	$^\circ\text{C}$
-------------------------------	-----------------	-----------------------	-----	---	-----	-----	---	-----	------------------

*Guaranteed by design, not tested in production.

7. Measured when the output voltage V_Q has dropped 100 mV from the nominal valued obtained at $V = 13.5\text{ V}$.

NCV4276, NCV4276A

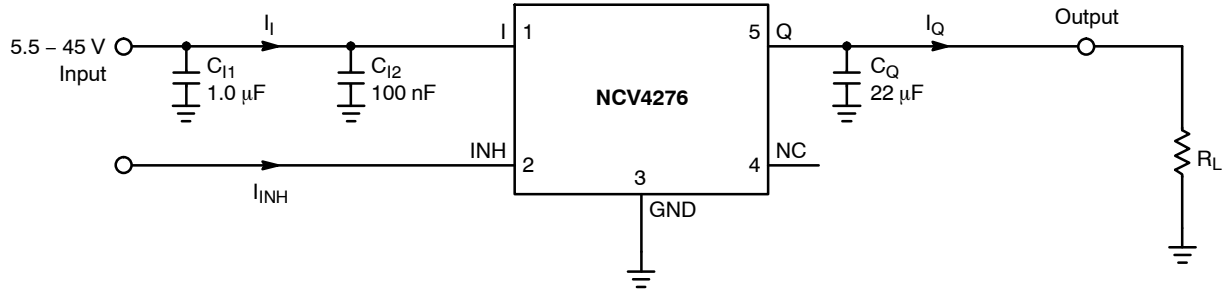
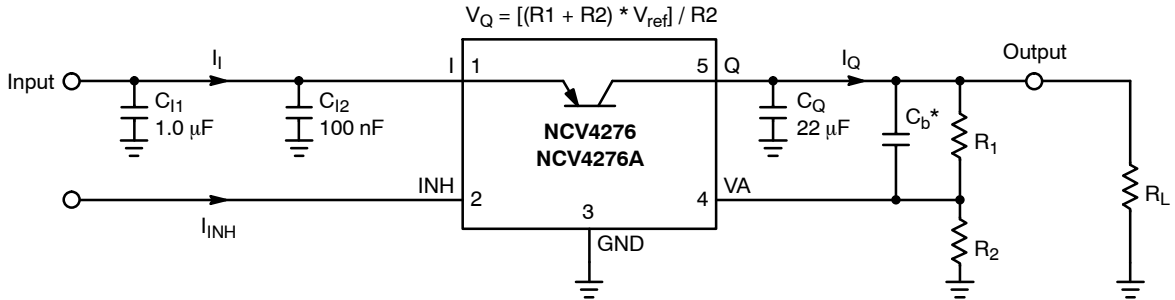

Figure 3. Applications Circuit; Fixed Voltage Version



C_b^* - Required if usage of low ESR output capacitor C_Q is demand, see Regulator Stability Considerations section

Figure 4. Applications Circuit; Adjustable Voltage Version

TYPICAL PERFORMANCE CHARACTERISTICS

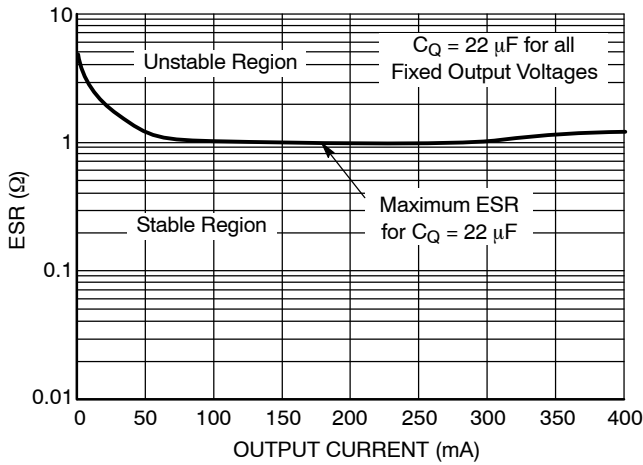

Figure 5. Output Stability with Output Capacitor ESR, 5.0 V, 3.3 V, 2.5 V and 1.8 V Regulator

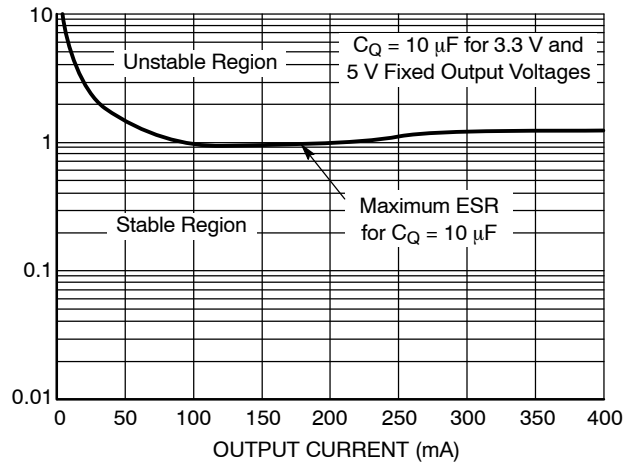

Figure 6. Output Stability with Output Capacitor ESR, 5.0 V and 3.3 V Regulator

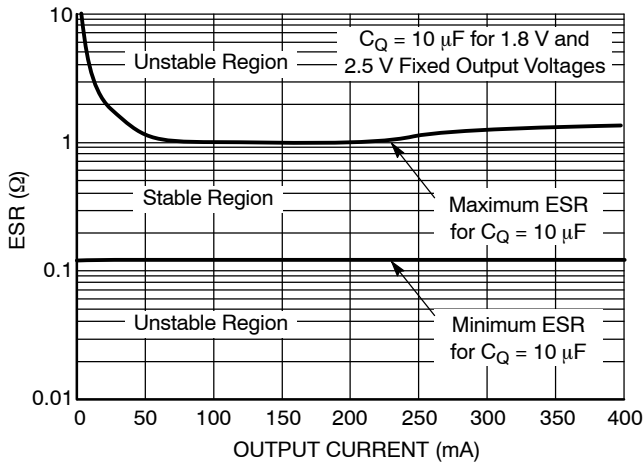

Figure 7. Output Stability with Output Capacitor ESR, 2.5 V and 1.8 V Regulator

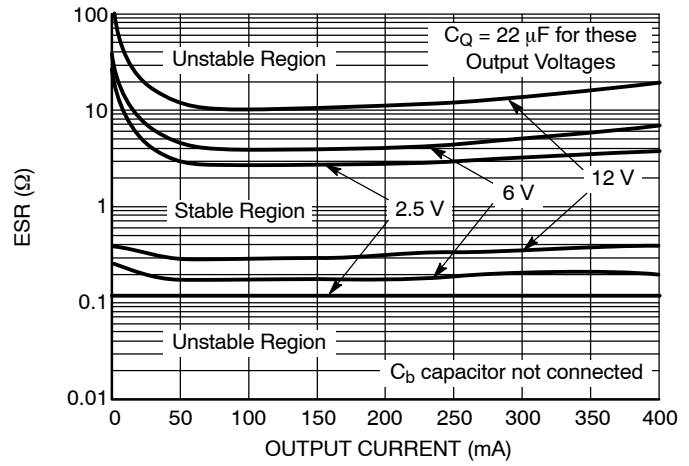

Figure 8. Output Stability with Output Capacitor ESR, Adjustable Regulator

NCV4276, NCV4276A

TYPICAL PERFORMANCE CHARACTERISTICS – 4276 Version

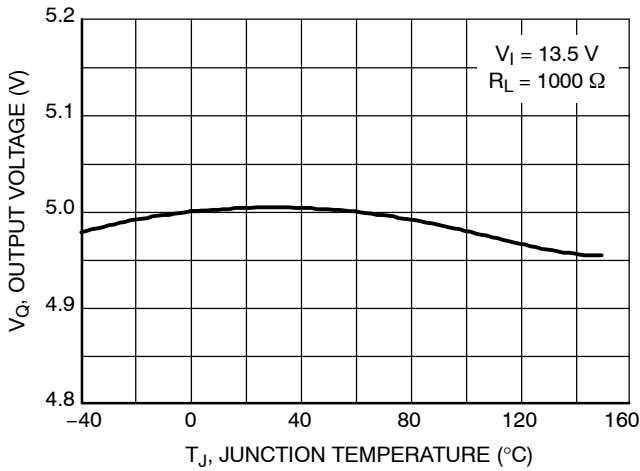

Figure 9. Output Voltage vs. Junction Temperature, 5.0 V Version

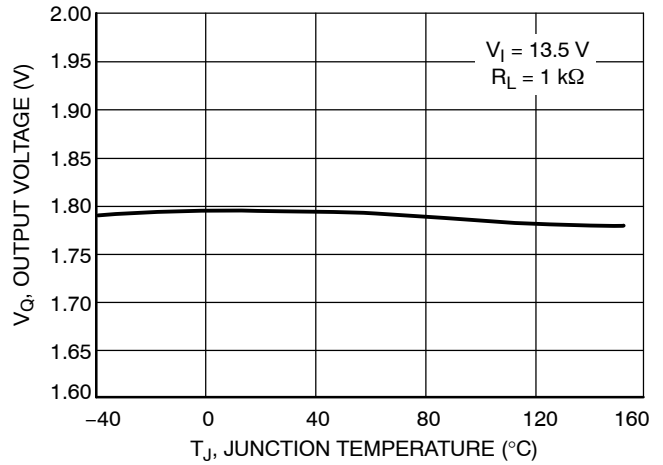

Figure 10. Output Voltage vs. Junction Temperature, 1.8 V Version

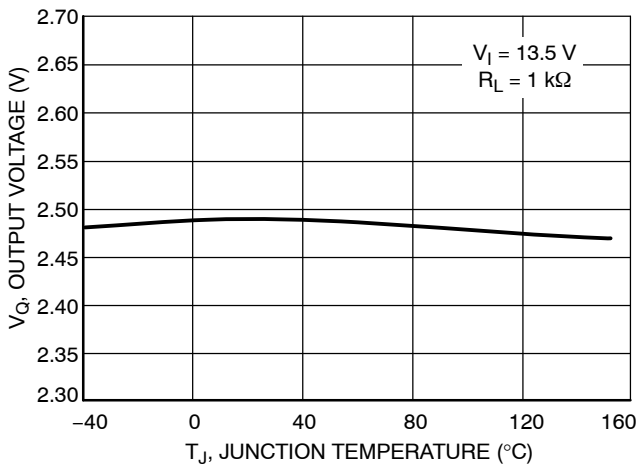

Figure 11. Output Voltage vs. Junction Temperature, 2.5 V Version

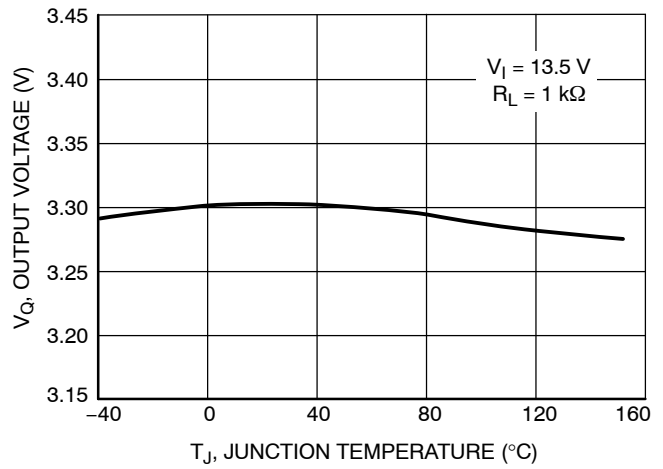

Figure 12. Output Voltage vs. Junction Temperature, 3.3 V Version

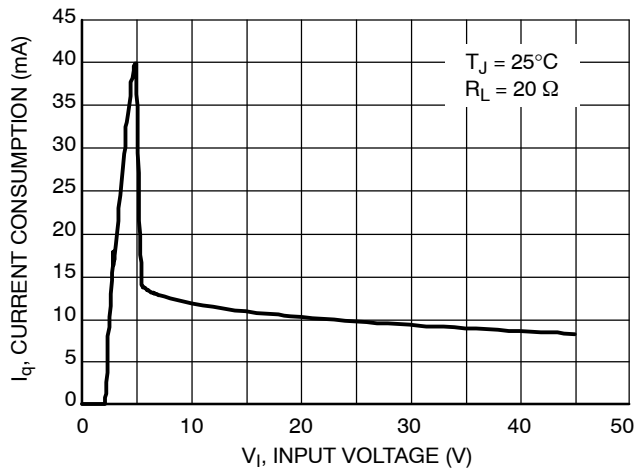

Figure 13. Current Consumption vs. Input Voltage, 5.0 V Version

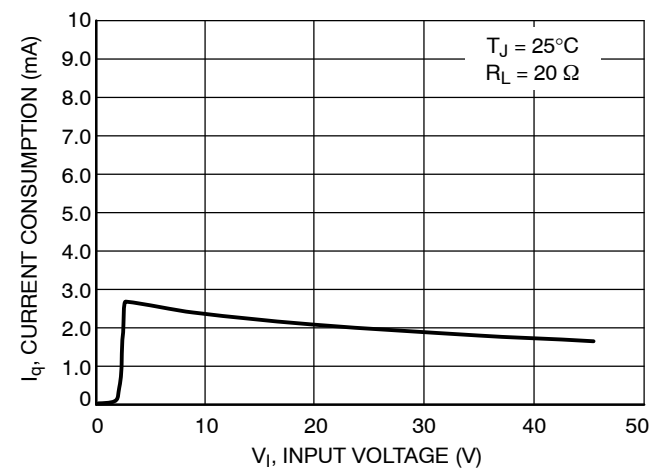

Figure 14. Current Consumption vs. Input Voltage, 1.8 V Version

TYPICAL PERFORMANCE CHARACTERISTICS – 4276 Version

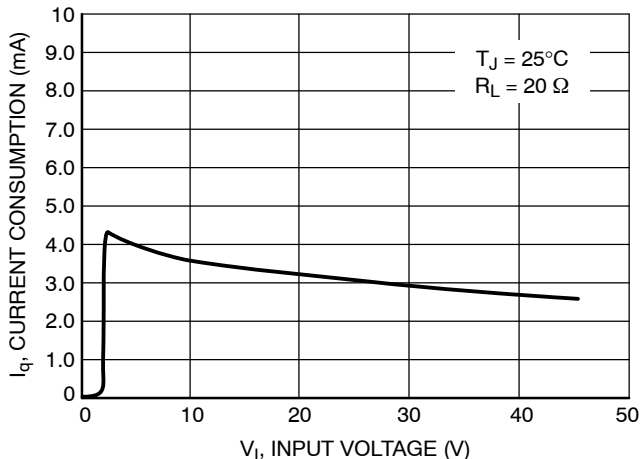

Figure 15. Current Consumption vs. Input Voltage, 2.5 V Version

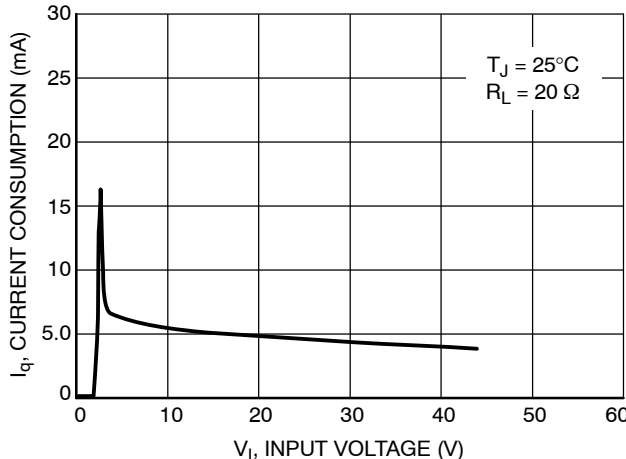

Figure 16. Current Consumption vs. Input Voltage, 3.3 V Version

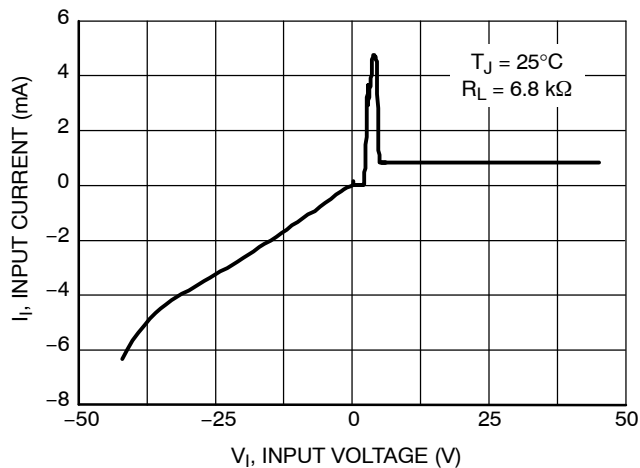

Figure 17. High Voltage Behavior

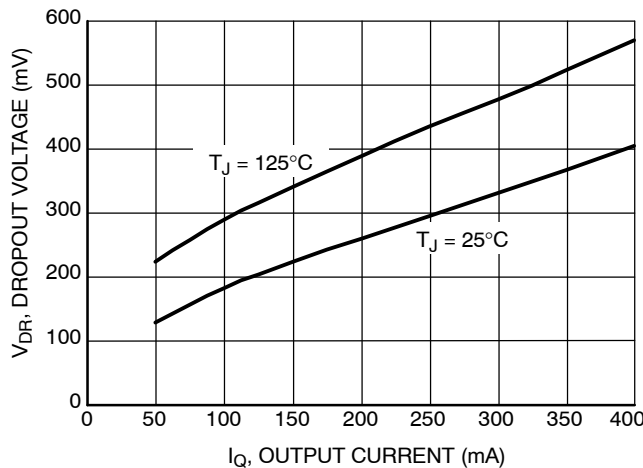

Figure 18. Dropout Voltage vs. Output Current, 5.0 V Version

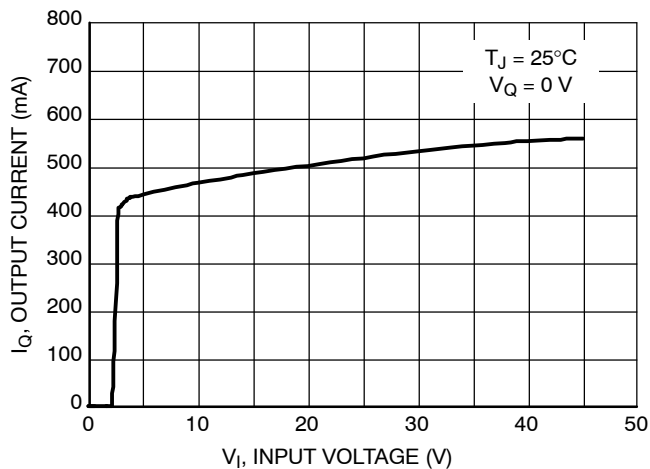

Figure 19. Maximum Output Current vs. Input Voltage

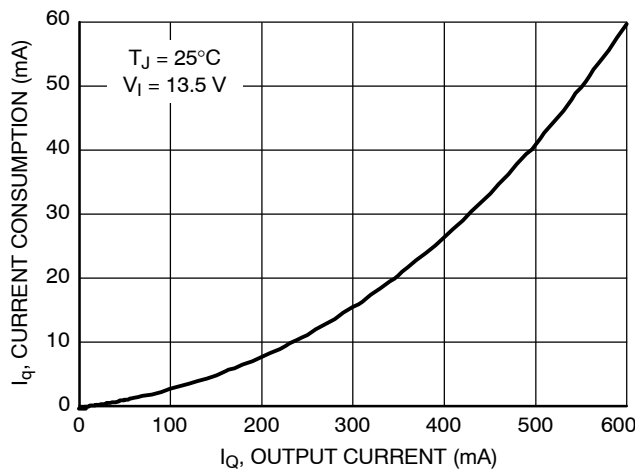

Figure 20. Current Consumption vs. Output Current (High Load)

TYPICAL PERFORMANCE CHARACTERISTICS – 4276 Version

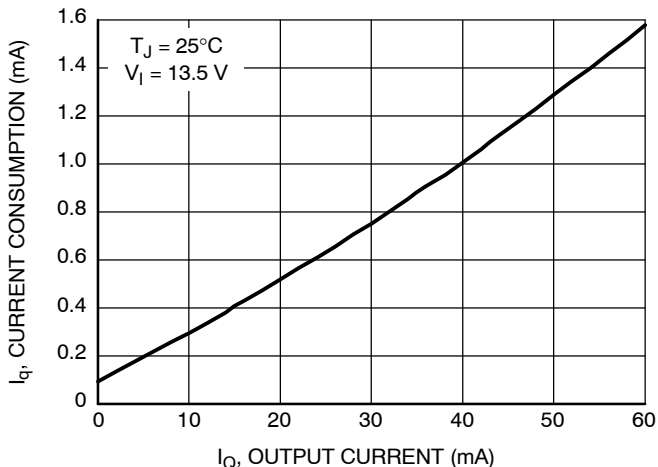

Figure 21. Current Consumption vs. Output Current (Low Load)

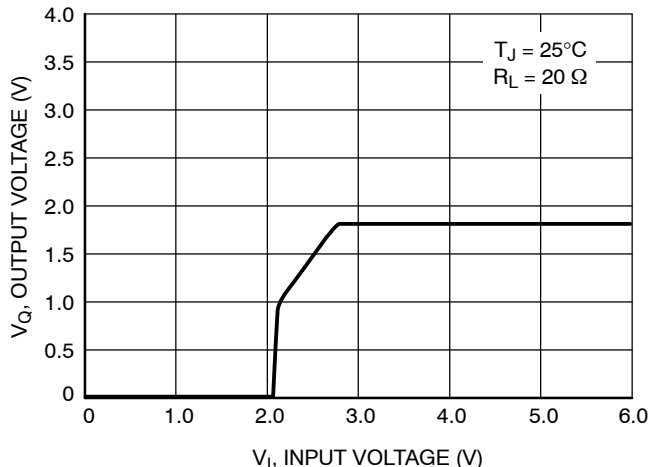

Figure 22. Output Voltage vs. Input Voltage, 1.8 V Version

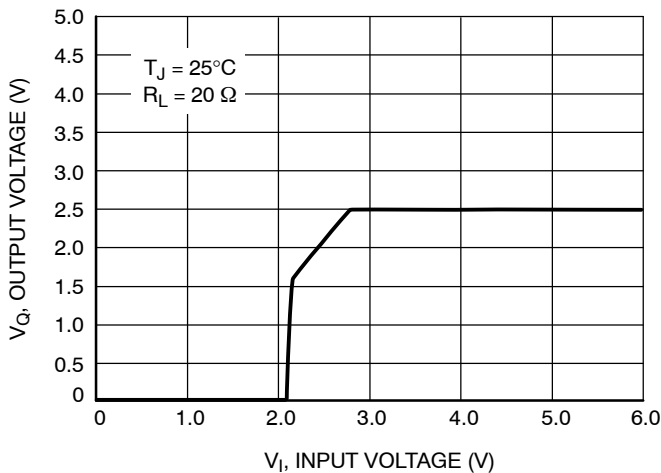

Figure 23. Output Voltage vs. Input Voltage, 2.5 V Version

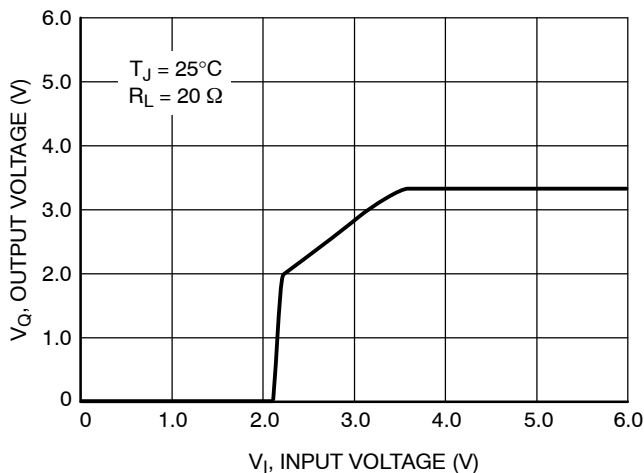

Figure 24. Output Voltage vs. Input Voltage, 3.3 V Version

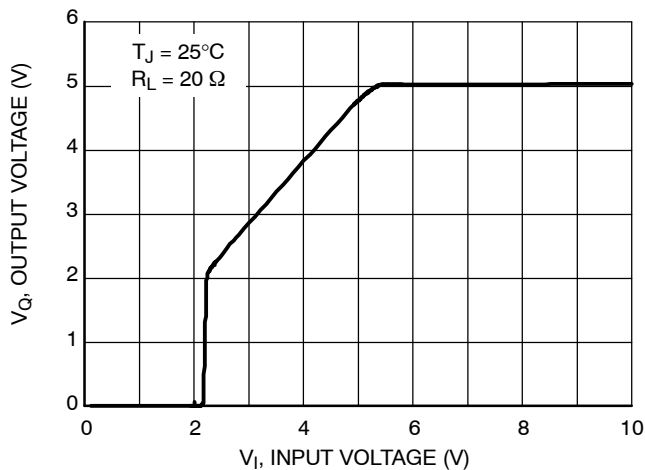

Figure 25. Output Voltage vs. Input Voltage, 5.0 V Version

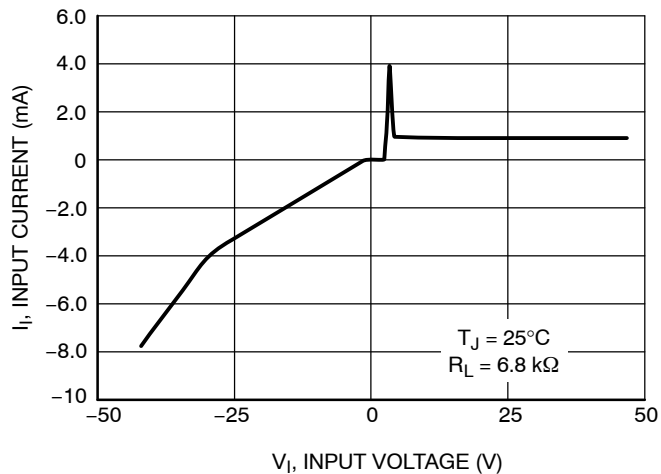

Figure 26. Input Current vs. Input Voltage, 5.0 V Version

TYPICAL PERFORMANCE CHARACTERISTICS – 4276 Version

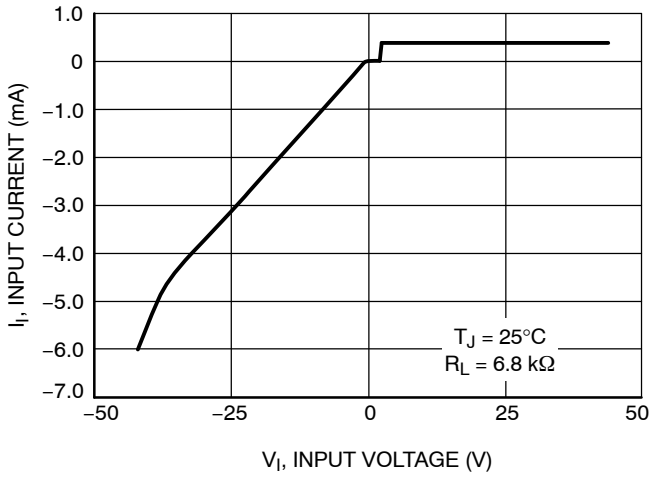

Figure 27. Input Current vs. Input Voltage, 1.8 V Version

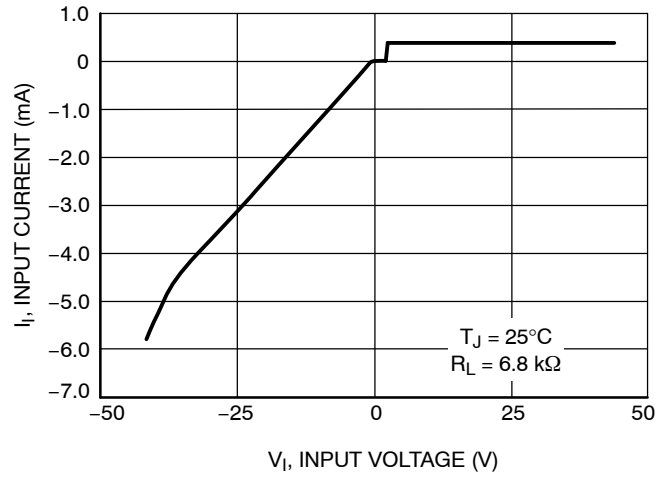

Figure 28. Input Current vs. Input Voltage, 2.5 V Version

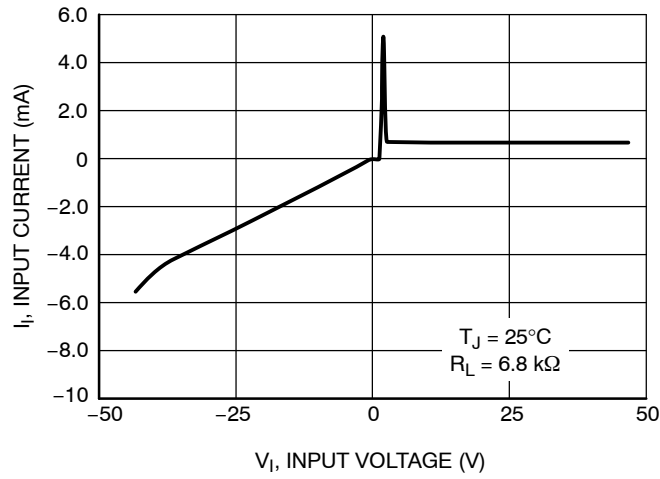

Figure 29. Input Current vs. Input Voltage, 3.3 V Version

TYPICAL PERFORMANCE CHARACTERISTICS – 4276A Version

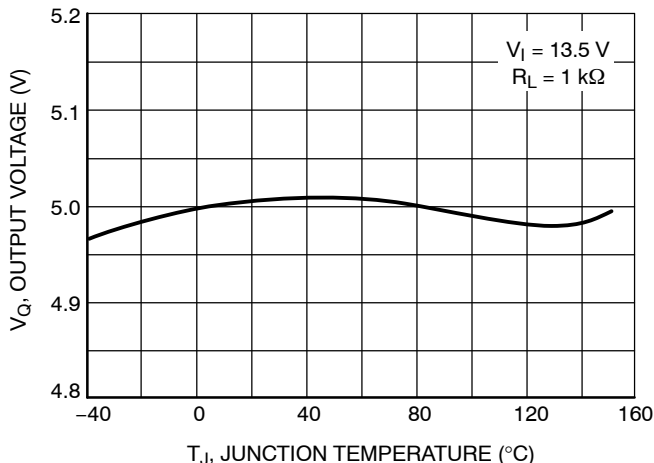

Figure 30. Output Voltage vs. Junction Temperature, 5.0 V Version

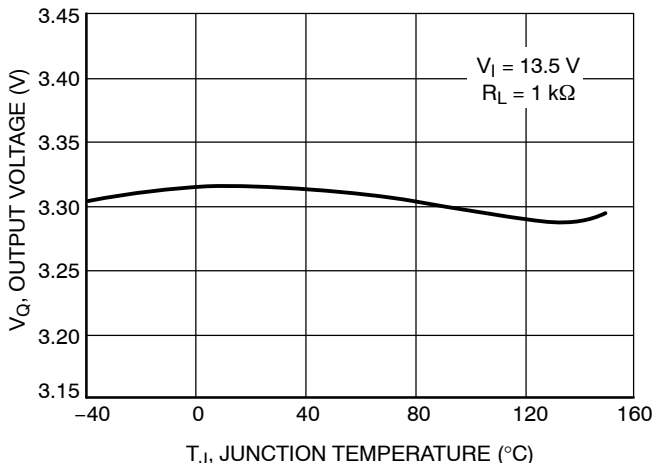

Figure 31. Output Voltage vs. Junction Temperature, 3.3 V Version

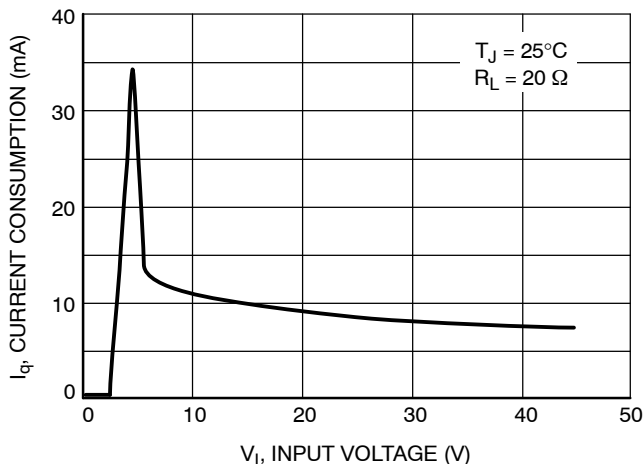

Figure 32. Current Consumption vs. Input Voltage, 5.0 V Version

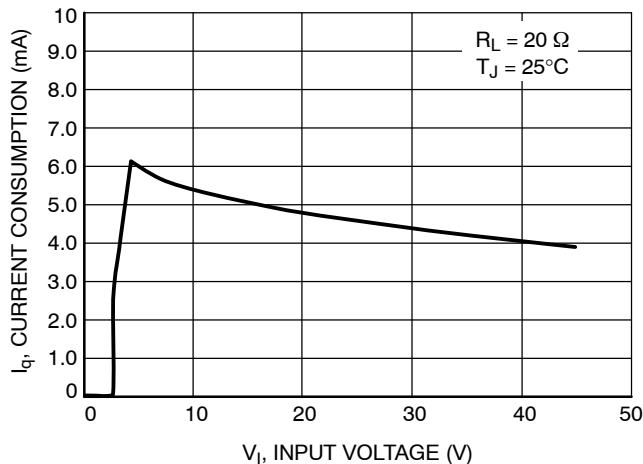

Figure 33. Current Consumption vs. Input Voltage, 3.3 V Version

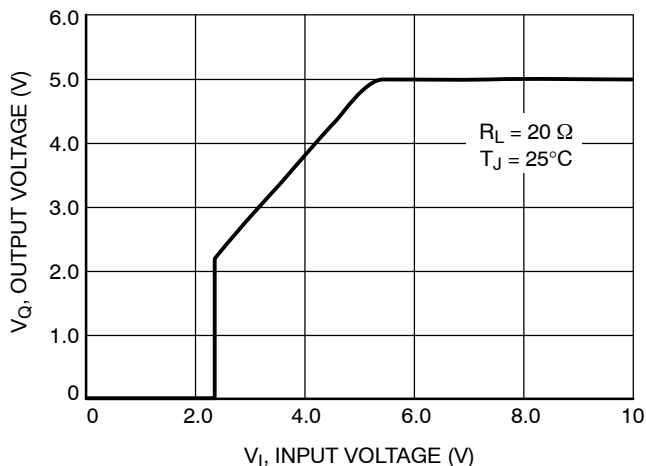

Figure 35. Low Voltage Behavior, 5.0 V Version

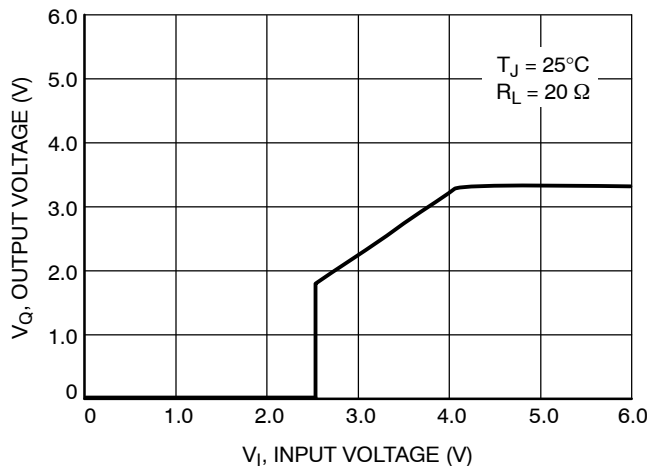

Figure 34. Low Voltage Behavior, 3.3 V Version

TYPICAL PERFORMANCE CHARACTERISTICS – 4276A Version

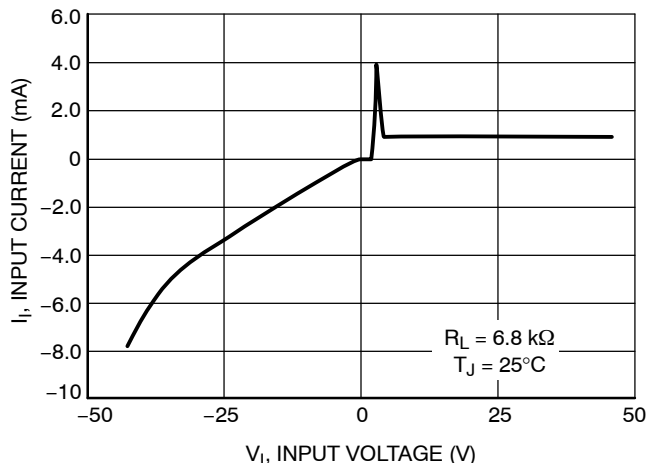

Figure 36. Input Current vs. Input Voltage, 5.0 V Version

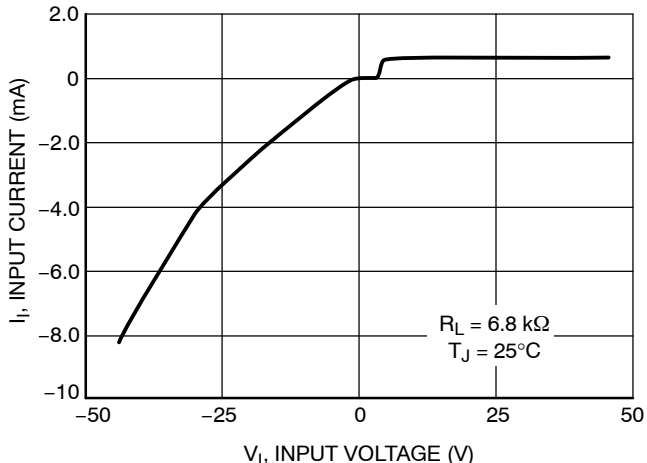

Figure 37. Input Current vs. Input Voltage, 3.3 V Version

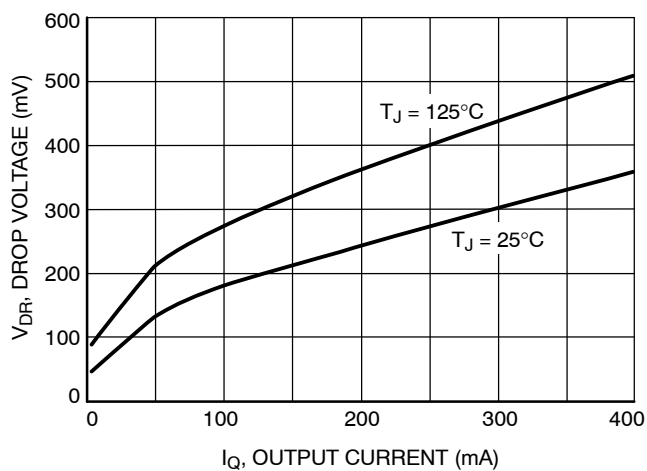

Figure 38. Dropout Voltage vs. Output Current

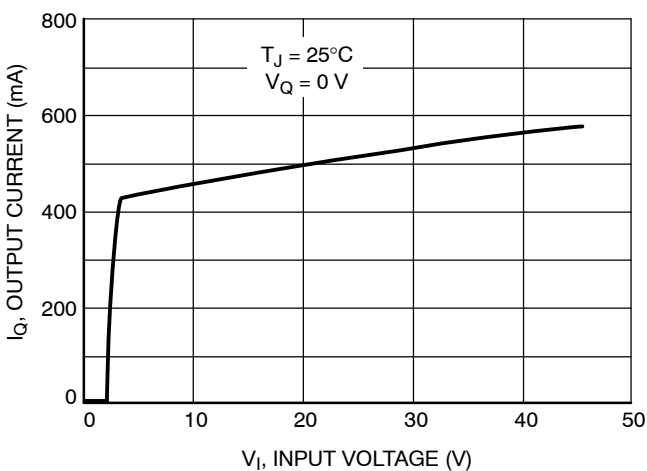

Figure 39. Maximum Output Current vs. Input Voltage

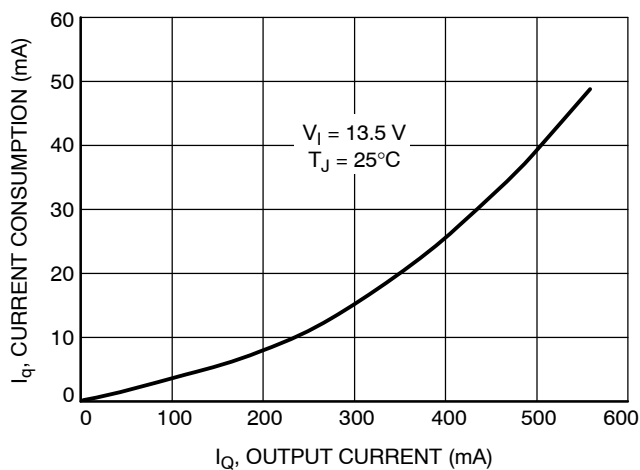

Figure 40. Current Consumption vs. Output Current (High Load)

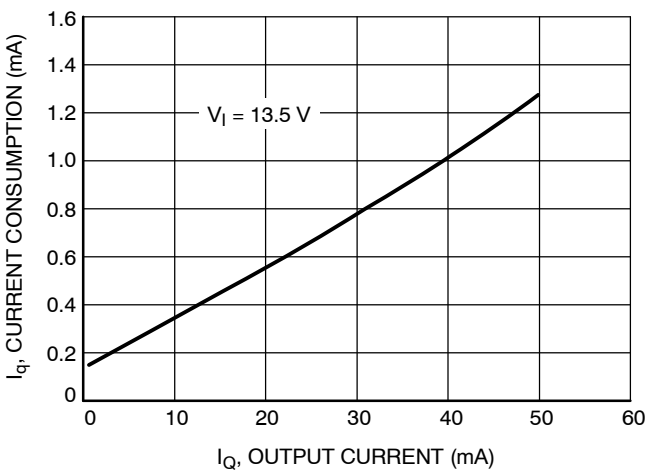

Figure 41. Current Consumption vs. Output Current (Low Load)

TYPICAL PERFORMANCE CHARACTERISTICS – Adjustable Version

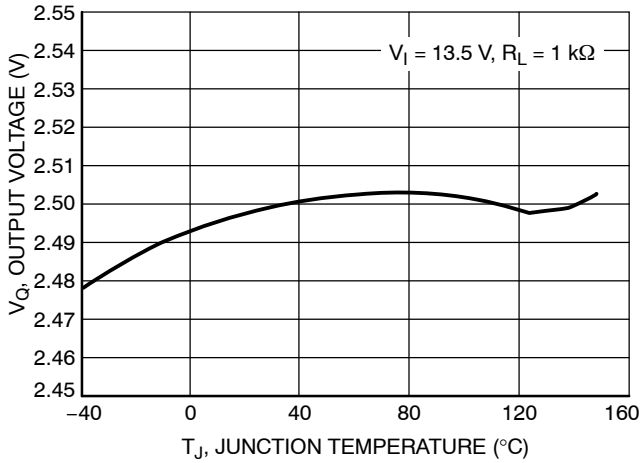

Figure 42. Output Voltage vs. Junction Temperature, Adjustable Version

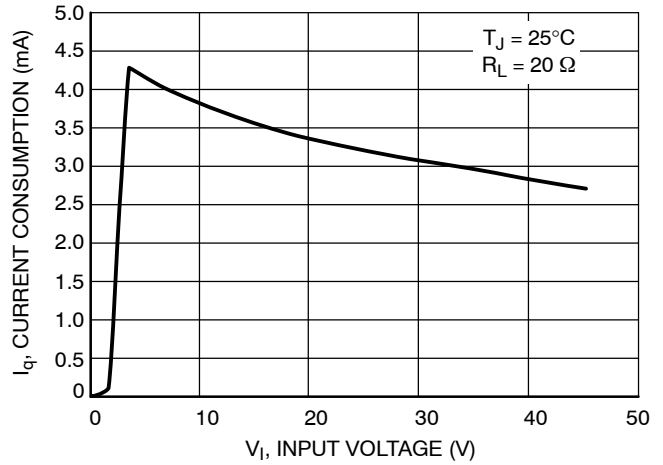

Figure 43. Current Consumption vs. Input Voltage, Adjustable Version

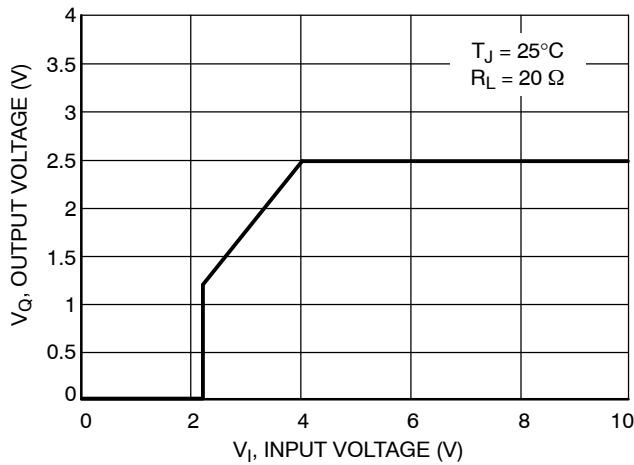

Figure 44. Low Voltage Behavior, Adjustable Version

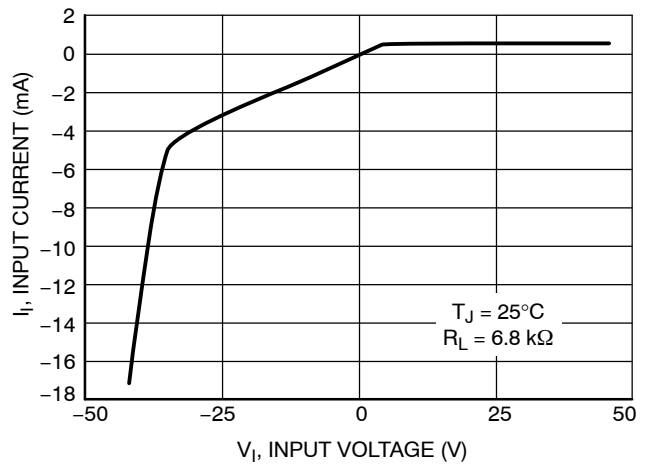

Figure 45. High Voltage Behavior, Adjustable Version

TYPICAL PERFORMANCE CHARACTERISTICS – Adjustable Version

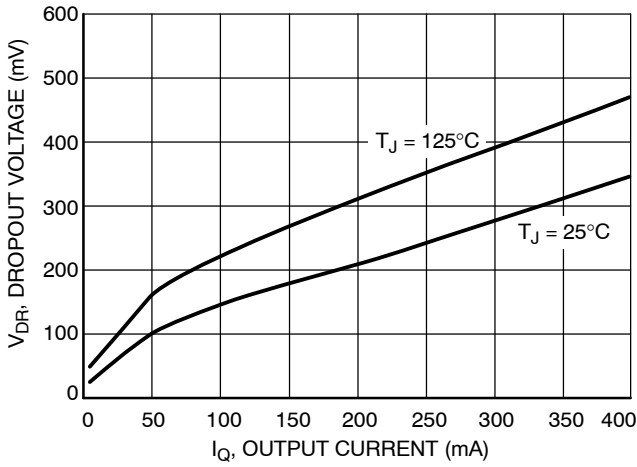

Figure 46. Dropout Voltage vs. Output Current, Regulator Set at 5.0 V, Adjustable Version

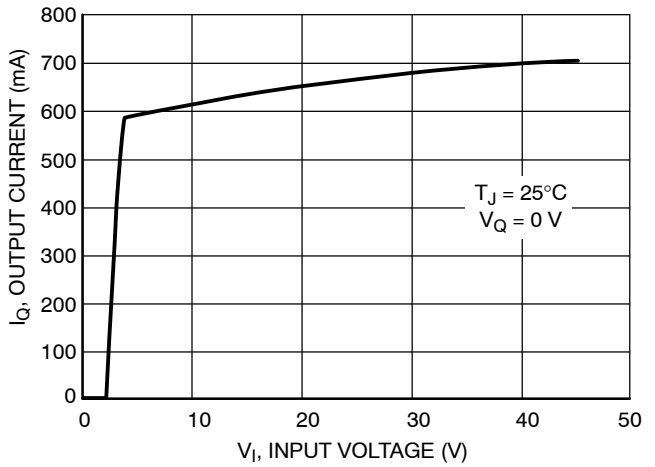

Figure 47. Maximum Output Current vs. Input Voltage, Adjustable Version

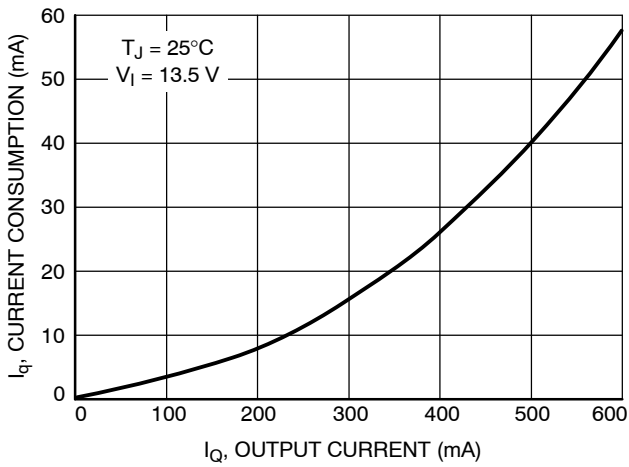

Figure 48. Current Consumption vs. Output Current (High Load), Adjustable Version

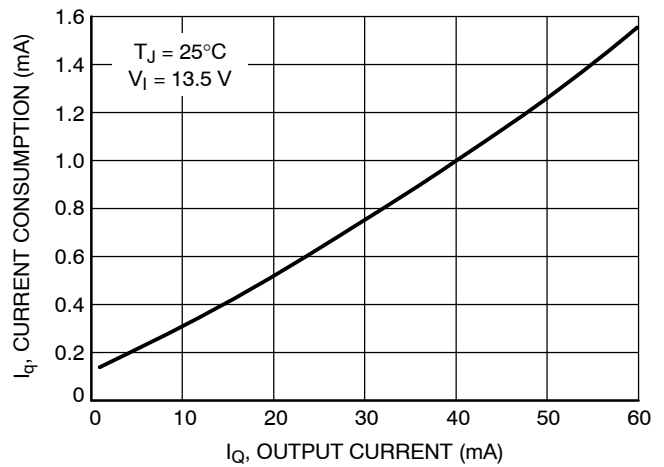

Figure 49. Current Consumption vs. Output Current (Low Load), Adjustable Version

Circuit Description

The NCV4276 is an integrated low dropout regulator that provides a regulated voltage at 400 mA to the output. It is enabled with an input to the inhibit pin. The regulator voltage is provided by a PNP pass transistor controlled by an error amplifier with a bandgap reference, which gives it the lowest possible dropout voltage. The output current capability is 400 mA, and the base drive quiescent current is controlled to prevent oversaturation when the input voltage is low or when the output is overloaded. The regulator is protected by both current limit and thermal shutdown. Thermal shutdown occurs above 150°C to protect the IC during overloads and extreme ambient temperatures.

Regulator

The error amplifier compares the reference voltage to a sample of the output voltage (V_O) and drives the base of a PNP series pass transistor via a buffer. The reference is a bandgap design to give it a temperature-stable output. Saturation control of the PNP is a function of the load current and input voltage. Oversaturation of the output power device is prevented, and quiescent current in the ground pin is minimized. See Figure 4, Test Circuit, for circuit element nomenclature illustration.

Regulator Stability Considerations

The input capacitors (C_{I1} and C_{I2}) are necessary to stabilize the input impedance to avoid voltage line influences. Using a resistor of approximately 1.0 Ω in series with C_{I2} can stop potential oscillations caused by stray inductance and capacitance.

The output capacitor helps determine three main characteristics of a linear regulator: startup delay, load transient response and loop stability. The capacitor value and type should be based on cost, availability, size and temperature constraints. The aluminum electrolytic capacitor is the least expensive solution, but, if the circuit operates at low temperatures (-25°C to -40°C), both the value and ESR of the capacitor will vary considerably. The capacitor manufacturer's data sheet usually provides this information.

The value for the output capacitor C_O , shown in Figure 3, should work for most applications; see also Figures 5 to 8 for output stability at various load and Output Capacitor ESR conditions. Stable region of ESR in Figures 5 to 8 shows ESR values at which the LDO output voltage does not have any permanent oscillations at any dynamic changes of output load current. Marginal ESR is the value at which the output voltage waving is fully damped during four periods after the load change and no oscillation is further observable.

ESR characteristics were measured with ceramic capacitors and additional series resistors to emulate ESR. Low duty cycle pulse load current technique has been used to maintain junction temperature close to ambient temperature.

Minimum ESR for $C_O = 22 \mu\text{F}$ is native ESR of ceramic capacitor with which the fixed output voltage devices are performing stable. Murata ceramic capacitors were used, GRM32ER71C226KE18 (22 μF , 16 V, X7R, 1210), GRM31CR71C106KAC7 (10 μF , 16 V, X7R, 1206).

Calculating Bypass Capacitor

If usage of low ESR ceramic capacitors is demand in case of Adjustable Regulator, connect the bypass capacitor C_b between Voltage Adjust pin and Q pin according to Applications circuit at Figure 4.

Parallel combination of bypass capacitor C_b with the feedback resistor R_1 contributes in the device transfer function as an additional zero and affects the device loop stability, therefore its value must be optimized. Attention to the Output Capacitor value and its ESR must be paid. See also Stability in High Speed Linear LDO Regulators Application Note, AND8037/D for more information.

Optimal value of bypass capacitor is given by following expression

$$C_b = \frac{1}{2 \times \pi \times f_z \times R_1} \cdot (F)$$

where

R_1 = the upper feedback resistor

f_z = the frequency of the zero added into the device transfer function by R_1 and C_b external components.

Set the R_1 resistor according to output voltage requirement. Chose the f_z with regard on the output capacitance C_O , refer to the table below.

C_O (μF)	10	22	47	100
f_z Range (kHz)	20 - 50	14 - 35	10 - 20	7 - 14

Ceramic capacitors and its part numbers listed bellow have been used as low ESR output capacitors C_O from the table above to define the frequency ranges of additional zero required for stability.

GRM31CR71C106KAC7 (10 μF , 16 V, X7R, 1206)

GRM32ER71C226KE18 (22 μF , 16 V, X7R, 1210)

GRM32ER61C476ME15 (47 μF , 16 V, X5R, 1210)

GRM32ER60J107ME20 (100 μF , 6.3 V, X5R, 1210)

Inhibit Input

The inhibit pin is used to turn the regulator on or off. By holding the pin down to a voltage less than 0.5 V (or 1.8 V for NCV4276A parts), the output of the regulator will be turned off. During startup transient the regulator is off at input voltage slew rates faster than 30 V/ μs . When the voltage on the Inhibit pin is greater than 3.5 V (or 2.8 V for NCV4276A parts), the output of the regulator will be enabled to power its output to the regulated output voltage. The inhibit pin may be connected directly to the input pin to give constant enable to the output regulator.

NCV4276, NCV4276A

Setting the Output Voltage (Adjustable Version)

The output voltage range of the adjustable version can be set between 2.5 V and 20 V. This is accomplished with an external resistor divider feeding back the voltage to the IC back to the error amplifier by the voltage adjust pin VA. The internal reference voltage is set to a temperature stable reference of 2.5 V.

The output voltage is calculated from the following formula. Ignoring the bias current into the VA pin:

$$V_Q = [(R1 + R2) * V_{ref}] / R2$$

Use $R2 < 50 \text{ k}$ to avoid significant voltage output errors due to VA bias current.

Connecting VA directly to Q without R1 and R2 creates an output voltage of 2.5 V.

Designers should consider the tolerance of R1 and R2 during the design phase.

The input voltage range for operation (pin 1) of the adjustable version is between $(V_Q + 0.5 \text{ V})$ and 40 V. Internal bias requirements dictate a minimum input voltage of 4.5 V. The dropout voltage for output voltages less than 4.0 V is $(4.5 \text{ V} - V_Q)$.

Calculating Power Dissipation in a Single Output Linear Regulator

The maximum power dissipation for a single output regulator (Figure 50) is:

$$P_{D(max)} = [V_{I(max)} - V_{Q(min)}] I_{Q(max)} + V_{I(max)} I_q \tag{1}$$

where

- $V_{I(max)}$ is the maximum input voltage,
- $V_{Q(min)}$ is the minimum output voltage,
- $I_{Q(max)}$ is the maximum output current for the application,
- I_q is the quiescent current the regulator consumes at $I_{Q(max)}$.

Once the value of $P_{D(max)}$ is known, the maximum permissible value of $R_{\theta JA}$ can be calculated:

$$R_{\theta JA} = \frac{150^{\circ}C - T_A}{P_D} \tag{2}$$

The value of $R_{\theta JA}$ can then be compared with those in the package section of the data sheet. Those packages with $R_{\theta JA}$ less than the calculated value in Equation 2 will keep the die temperature below 150°C.

In some cases, none of the packages will be sufficient to dissipate the heat generated by the IC, and an external heatsink will be required.

Heatsinks

A heatsink effectively increases the surface area of the package to improve the flow of heat away from the IC and into the surrounding air.

Each material in the heat flow path between the IC and the outside environment will have a thermal resistance. Like series electrical resistances, these resistances are summed to determine the value of $R_{\theta JA}$:

$$R_{\theta JA} = R_{\theta JC} + R_{\theta CS} + R_{\theta SA} \tag{3}$$

where

- $R_{\theta JC}$ is the junction-to-case thermal resistance,
- $R_{\theta CS}$ is the case-to-heatsink thermal resistance,
- $R_{\theta SA}$ is the heatsink-to-ambient thermal resistance.

$R_{\theta JC}$ appears in the package section of the data sheet. Like $R_{\theta JA}$, it too is a function of package type. $R_{\theta CS}$ and $R_{\theta SA}$ are functions of the package type, heatsink and the interface between them. These values appear in data sheets of heatsink manufacturers.

Thermal, mounting, and heatsinking considerations are discussed in the ON Semiconductor application note AN1040/D.

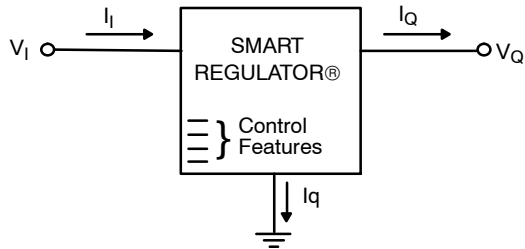

Figure 50. Single Output Regulator with Key Performance Parameters Labeled

NCV4276, NCV4276A

Thermal Model

A discussion of thermal modeling is in the ON Semiconductor web site: <http://www.onsemi.com/pub/collateral/BR1487-D.PDF>.

Table 1. DPAK 5-Lead Thermal RC Network Models

Drain Copper Area (1 oz thick)			168 mm ²	736 mm ²		168 mm ²	736 mm ²	
(SPICE Deck Format)			Cauer Network			Foster Network		
			168 mm ²	736 mm ²	Units	Tau	Tau	Units
C_C1	Junction	GND	1.00E-06	1.00E-06	W-s/C	1.36E-08	1.361E-08	sec
C_C2	node1	GND	1.00E-05	1.00E-05	W-s/C	7.41E-07	7.411E-07	sec
C_C3	node2	GND	6.00E-05	6.00E-05	W-s/C	1.04E-05	1.029E-05	sec
C_C4	node3	GND	1.00E-04	1.00E-04	W-s/C	3.91E-05	3.737E-05	sec
C_C5	node4	GND	4.36E-04	3.64E-04	W-s/C	1.80E-03	1.376E-03	sec
C_C6	node5	GND	6.77E-02	1.92E-02	W-s/C	3.77E-01	2.851E-02	sec
C_C7	node6	GND	1.51E-01	1.27E-01	W-s/C	3.79E+00	9.475E-01	sec
C_C8	node7	GND	4.80E-01	1.018	W-s/C	2.65E+01	1.173E+01	sec
C_C9	node8	GND	3.740	2.955	W-s/C	8.71E+01	8.59E+01	sec
C_C10	node9	GND	10.322	0.438	W-s/C			sec
			168 mm ²	736 mm ²		R's	R's	
R_R1	Junction	node1	0.015	0.015	C/W	0.0123	0.0123	C/W
R_R2	node1	node2	0.08	0.08	C/W	0.0585	0.0585	C/W
R_R3	node2	node3	0.4	0.4	C/W	0.0304	0.0287	C/W
R_R4	node3	node4	0.2	0.2	C/W	0.3997	0.3772	C/W
R_R5	node4	node5	2.97519	2.6171	C/W	3.115	2.68	C/W
R_R6	node5	node6	8.2971	1.6778	C/W	3.571	1.38	C/W
R_R7	node6	node7	25.9805	7.4246	C/W	12.851	5.92	C/W
R_R8	node7	node8	46.5192	14.9320	C/W	35.471	7.39	C/W
R_R9	node8	node9	17.7808	19.2560	C/W	46.741	28.94	C/W
R_R10	node9	GND	0.1	0.1758	C/W			C/W

NOTE: Bold face items represent the package without the external thermal system.

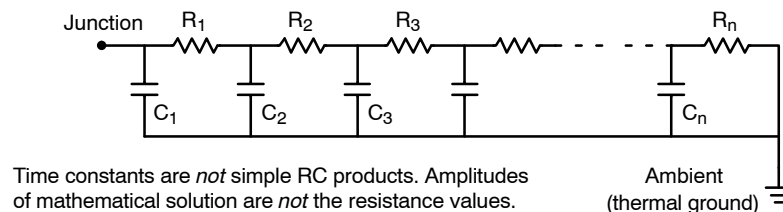

Figure 51. Grounded Capacitor Thermal Network ("Cauer" Ladder)

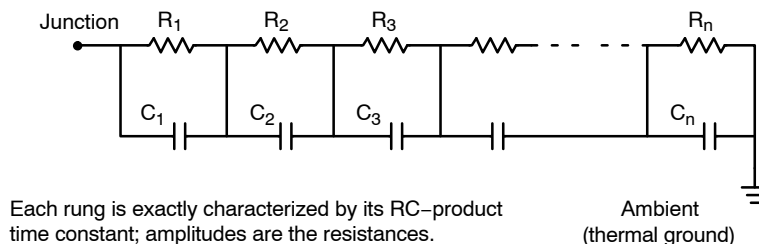

Figure 52. Non-Grounded Capacitor Thermal Ladder ("Foster" Ladder)

NCV4276, NCV4276A

Table 2. D²PAK 5-Lead Thermal RC Network Models

Drain Copper Area (1 oz thick)			241 mm ²	788 mm ²		241 mm ²	788 mm ²	
(SPICE Deck Format)			Cauer Network			Foster Network		
			241 mm ²	653 mm ²	Units	Tau	Tau	Units
C_C1	Junction	GND	1.00E-06	1.00E-06	W-s/C	1.361E-08	1.361E-08	sec
C_C2	node1	GND	1.00E-05	1.00E-05	W-s/C	7.411E-07	7.411E-07	sec
C_C3	node2	GND	6.00E-05	6.00E-05	W-s/C	1.005E-05	1.007E-05	sec
C_C4	node3	GND	1.00E-04	1.00E-04	W-s/C	3.460E-05	3.480E-05	sec
C_C5	node4	GND	2.82E-04	2.87E-04	W-s/C	7.868E-04	8.107E-04	sec
C_C6	node5	GND	5.58E-03	5.95E-03	W-s/C	7.431E-03	7.830E-03	sec
C_C7	node6	GND	4.25E-01	4.61E-01	W-s/C	2.786E+00	2.012E+00	sec
C_C8	node7	GND	9.22E-01	2.05	W-s/C	2.014E+01	2.601E+01	sec
C_C9	node8	GND	1.73	4.88	W-s/C	1.134E+02	1.218E+02	sec
C_C10	node9	GND	7.12	1.31	W-s/C			sec
			241 mm ²	653 mm ²		R's	R's	
R_R1	Junction	node1	0.015	0.0150	C/W	0.0123	0.0123	C/W
R_R2	node1	node2	0.08	0.0800	C/W	0.0585	0.0585	C/W
R_R3	node2	node3	0.4	0.4000	C/W	0.0257	0.0260	C/W
R_R4	node3	node4	0.2	0.2000	C/W	0.3413	0.3438	C/W
R_R5	node4	node5	1.85638	1.8839	C/W	1.77	1.81	C/W
R_R6	node5	node6	1.23672	1.2272	C/W	1.54	1.52	C/W
R_R7	node6	node7	9.81541	5.3383	C/W	4.13	3.46	C/W
R_R8	node7	node8	33.1868	18.9591	C/W	6.27	5.03	C/W
R_R9	node8	node9	27.0263	13.3369	C/W	60.80	29.30	C/W
R_R10	node9	GND	1.13944	0.1191	C/W			C/W

NOTE: Bold face items represent the package without the external thermal system.

The Cauer networks generally have physical significance and may be divided between nodes to separate thermal behavior due to one portion of the network from another. The Foster networks, though when sorted by time constant (as above) bear a rough correlation with the Cauer networks, are really only convenient mathematical models. Cauer networks can be easily implemented using circuit simulating tools, whereas Foster networks may be more easily implemented using mathematical tools (for instance, in a spreadsheet program), according to the following formula:

$$R(t) = \sum_{i=1}^n R_i (1 - e^{-t/\tau_i})$$

NCV4276, NCV4276A

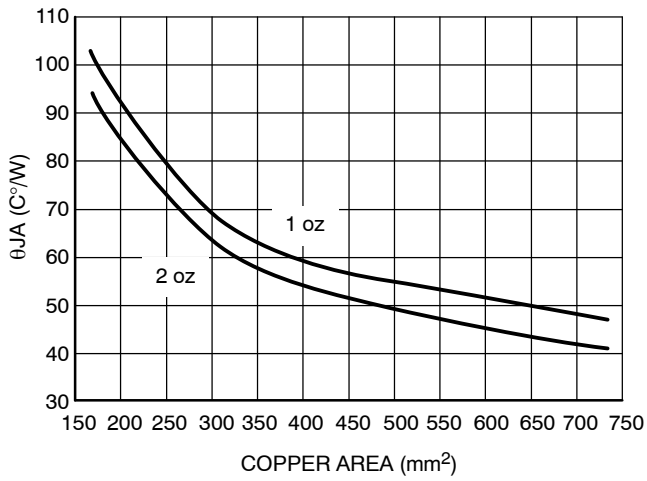

Figure 53. θ_{JA} vs. Copper Spreader Area, DPAK 5-Lead

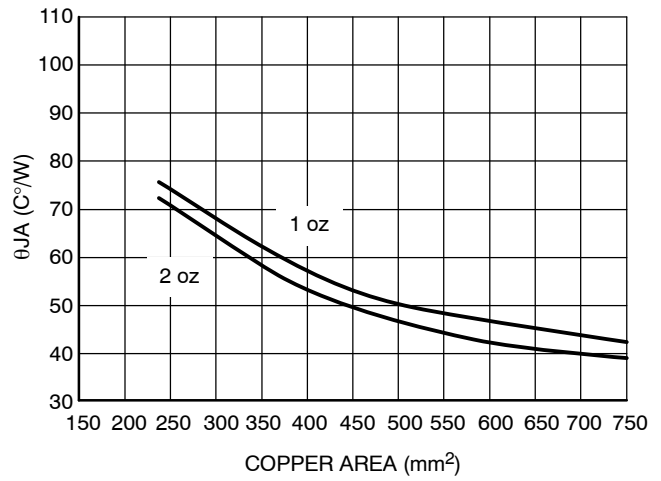

Figure 54. θ_{JA} vs. Copper Spreader Area, D^2PAK 5-Lead

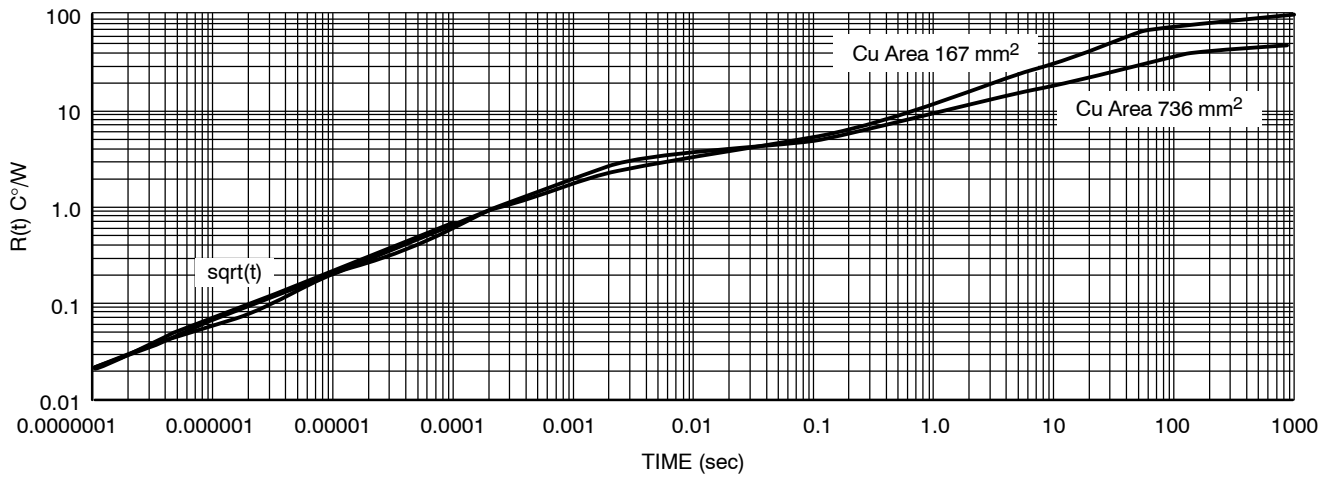

Figure 55. Single-Pulse Heating Curves, DPAK 5-Lead

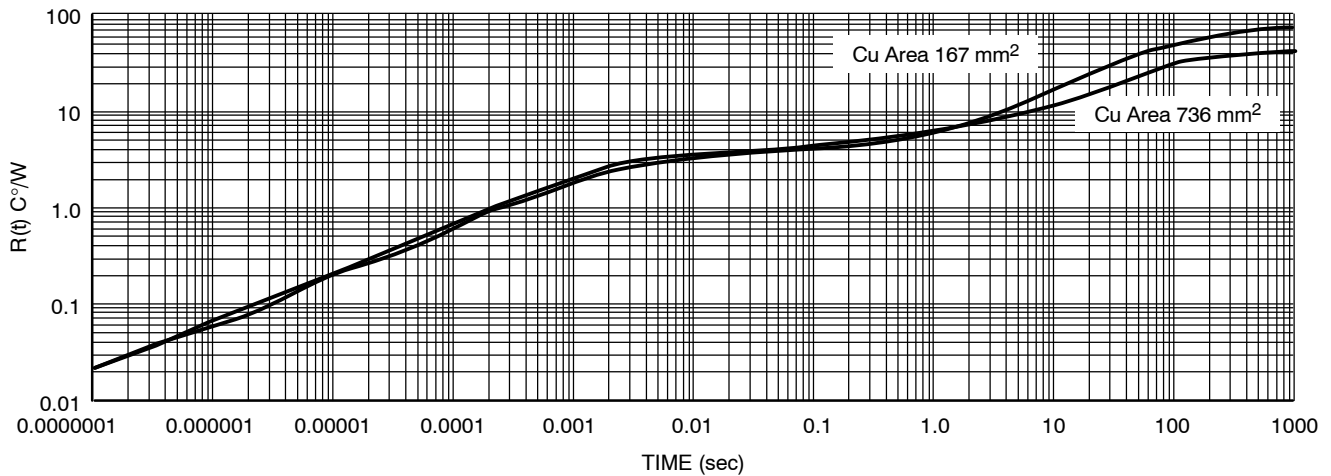

Figure 56. Single-Pulse Heating Curves, D^2PAK 5-Lead

NCV4276, NCV4276A

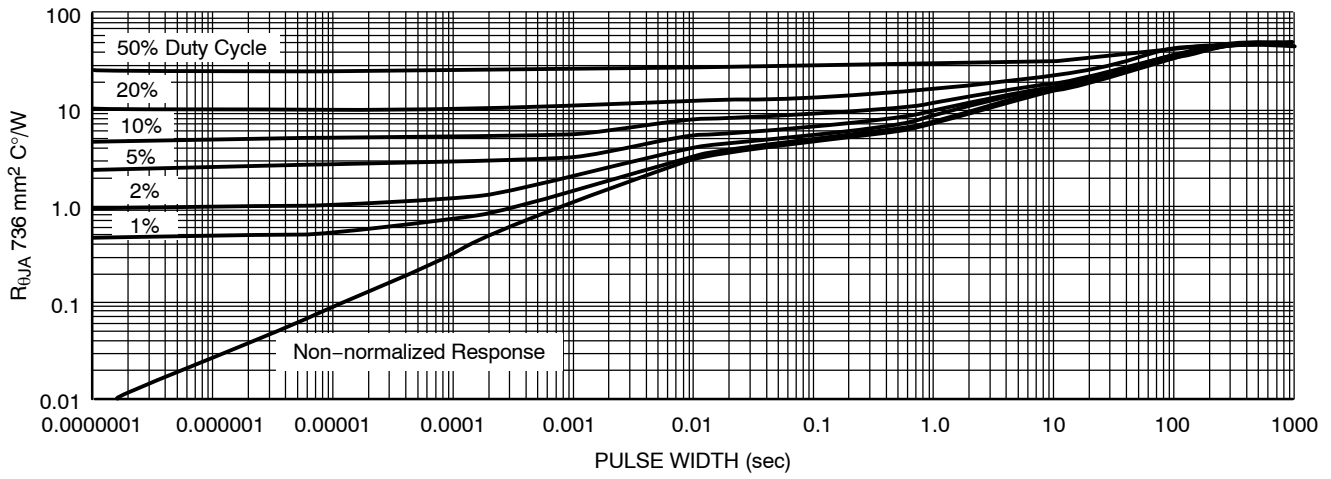

Figure 57. Duty Cycle for 1" Spreader Boards, DPAK 5-Lead

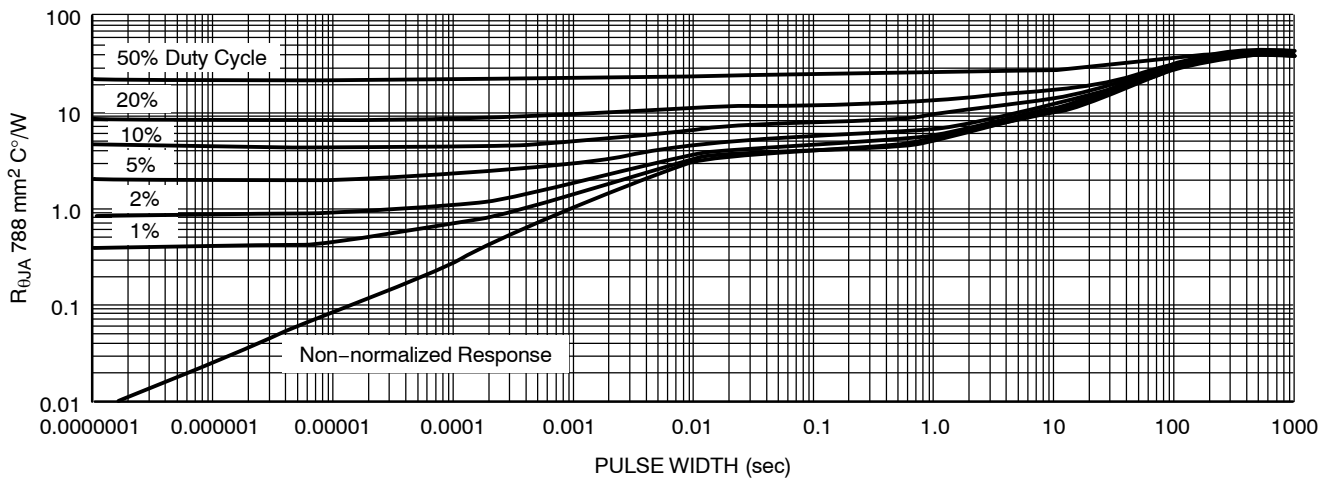
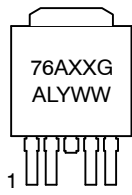

Figure 58. Duty Cycle for 1" Spreader Boards, D²PAK 5-Lead

NCV4276, NCV4276A

MARKING DIAGRAMS



NCV4276A
DPAK
5-PIN
DT SUFFIX
CASE 175AA

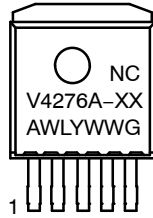

NCV4276A
D²PAK
5-PIN
DS SUFFIX
CASE 936A

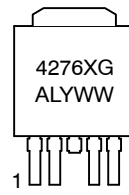

NCV4276
DPAK
5-PIN
DT SUFFIX
CASE 175AA

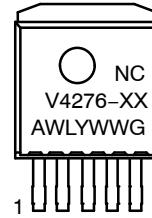

NCV4276
D²PAK
5-PIN
DS SUFFIX
CASE 936A

*Tab is connected to Pin 3 on all packages.

A = Assembly Location
 WL, L = Wafer Lot
 Y = Year
 WW = Work Week
 G = Pb-Free Device
 x, xx = Voltage Ratings as indicated below

A-Version

DPAK	D ² PAK
XX = AJ (Adj. Voltage)	XX = AJ (Adj. Voltage)
XX = 50 (5.0 V)	XX = 50 (5.0 V)
XX = 33 (3.3 V)	

Non-A-Version

DPAK	D ² PAK
X = V (Adj. Voltage)	XX = AJ (Adj. Voltage)
X = 5 (5.0 V)	XX = 50 (5.0 V)
X = 3 (3.3 V)	XX = 33 (3.3 V)
	XX = 25 (2.5 V)
	XX = 18 (1.8 V)

NCV4276, NCV4276A

ORDERING INFORMATION

Device	Output Voltage Accuracy	Output Voltage	Package	Shipping†
NCV4276DT50RKG	4%	5.0 V	DPAK, 5-Pin (Pb-Free)	2500 / Tape & Reel
NCV4276DS50G			D ² PAK, 5-Pin (Pb-Free)	50 Units / Rail
NCV4276DS50R4G			D ² PAK, 5-Pin (Pb-Free)	800 / Tape & Reel
NCV4276DT33RKG		3.3 V	DPAK, 5-Pin (Pb-Free)	2500 / Tape & Reel
NCV4276DS33G			D ² PAK, 5-Pin (Pb-Free)	50 Units / Rail
NCV4276DS33R4G			D ² PAK, 5-Pin (Pb-Free)	800 / Tape & Reel
NCV4276DS25G		2.5 V	D ² PAK, 5-Pin (Pb-Free)	50 Units / Rail
NCV4276DS25R4G			D ² PAK, 5-Pin (Pb-Free)	800 / Tape & Reel
NCV4276DS18G		1.8 V	D ² PAK, 5-Pin (Pb-Free)	50 Units / Rail
NCV4276DS18R4G			D ² PAK, 5-Pin (Pb-Free)	800 / Tape & Reel
NCV4276DTADJRKG		Adjustable	DPAK, 5-Pin (Pb-Free)	2500 / Tape & Reel
NCV4276DSADJG			D ² PAK, 5-Pin (Pb-Free)	50 Units / Rail
NCV4276DSADJR4G			D ² PAK, 5-Pin (Pb-Free)	800 / Tape & Reel
NCV4276ADT33RKG	2%	3.3 V	DPAK, 5-Pin (Pb-Free)	2500 / Tape & Reel
NCV4276ADT50RKG		5.0 V	DPAK, 5-Pin (Pb-Free)	2500 / Tape & Reel
NCV4276ADS50G			D ² PAK, 5-Pin (Pb-Free)	50 Units / Rail
NCV4276ADS50R4G		D ² PAK, 5-Pin (Pb-Free)	800 / Tape & Reel	
NCV4276ADTADJRKG		Adjustable	DPAK, 5-Pin (Pb-Free)	2500 / Tape & Reel
NCV4276ADSADJG			D ² PAK, 5-Pin (Pb-Free)	50 Units / Rail
NCV4276ADSADJR4G			D ² PAK, 5-Pin (Pb-Free)	800 / Tape & Reel

†For information on tape and reel specifications, including part orientation and tape sizes, please refer to our Tape and Reel Packaging Specifications Brochure, BRD8011/D.

MECHANICAL CASE OUTLINE

PACKAGE DIMENSIONS

ON Semiconductor®

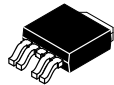

DPAK-5, CENTER LEAD CROP

CASE 175AA

ISSUE B

DATE 15 MAY 2014

SCALE 1:1

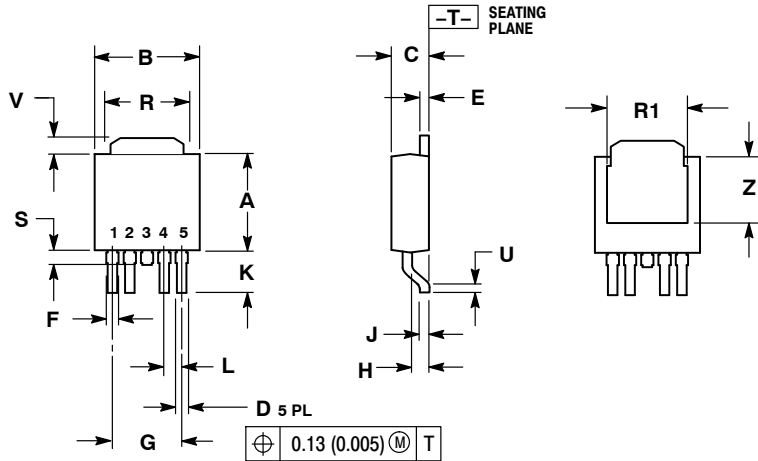

- NOTES:
- DIMENSIONING AND TOLERANCING PER ANSI Y14.5M, 1982.
 - CONTROLLING DIMENSION: INCH.

DIM	INCHES		MILLIMETERS	
	MIN	MAX	MIN	MAX
A	0.235	0.245	5.97	6.22
B	0.250	0.265	6.35	6.73
C	0.086	0.094	2.19	2.38
D	0.020	0.028	0.51	0.71
E	0.018	0.023	0.46	0.58
F	0.024	0.032	0.61	0.81
G	0.180 BSC		4.56 BSC	
H	0.034	0.040	0.87	1.01
J	0.018	0.023	0.46	0.58
K	0.102	0.114	2.60	2.89
L	0.045 BSC		1.14 BSC	
R	0.170	0.190	4.32	4.83
R1	0.185	0.210	4.70	5.33
S	0.025	0.040	0.63	1.01
U	0.020	---	0.51	---
V	0.035	0.050	0.89	1.27
Z	0.155	0.170	3.93	4.32

RECOMMENDED SOLDERING FOOTPRINT*

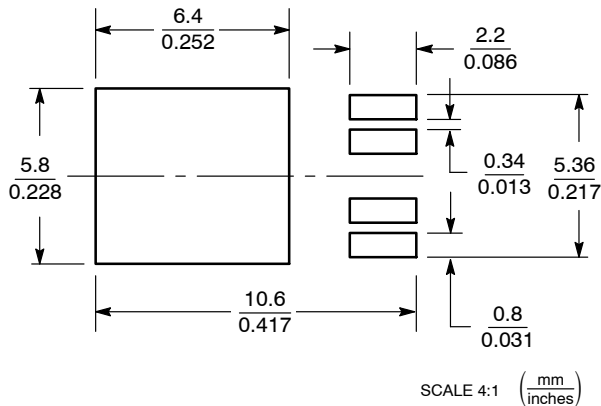

*For additional information on our Pb-Free strategy and soldering details, please download the ON Semiconductor Soldering and Mounting Techniques Reference Manual, SOLDERRM/D.

GENERIC MARKING DIAGRAMS*

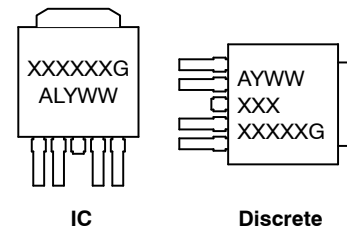

- XXXXXX = Device Code
- A = Assembly Location
- L = Wafer Lot
- Y = Year
- WW = Work Week
- G = Pb-Free Package

*This information is generic. Please refer to device data sheet for actual part marking. Pb-Free indicator, "G" or microdot "▪", may or may not be present.

DOCUMENT NUMBER:	98AON12855D	Electronic versions are uncontrolled except when accessed directly from the Document Repository. Printed versions are uncontrolled except when stamped "CONTROLLED COPY" in red.
DESCRIPTION:	DPAK-5 CENTER LEAD CROP	PAGE 1 OF 1

ON Semiconductor and are trademarks of Semiconductor Components Industries, LLC dba ON Semiconductor or its subsidiaries in the United States and/or other countries. ON Semiconductor reserves the right to make changes without further notice to any products herein. ON Semiconductor makes no warranty, representation or guarantee regarding the suitability of its products for any particular purpose, nor does ON Semiconductor assume any liability arising out of the application or use of any product or circuit, and specifically disclaims any and all liability, including without limitation special, consequential or incidental damages. ON Semiconductor does not convey any license under its patent rights nor the rights of others.

MECHANICAL CASE OUTLINE

PACKAGE DIMENSIONS

ON Semiconductor®

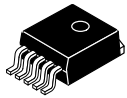

D²PAK 5-LEAD CASE 936A-02 ISSUE E

DATE 28 JUL 2021

SCALE 1:1

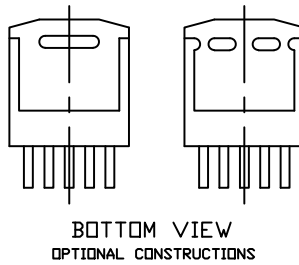
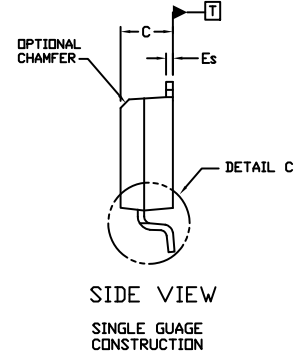
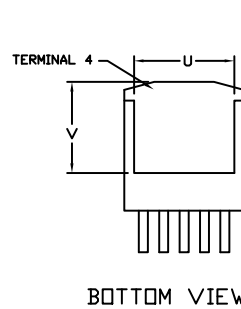
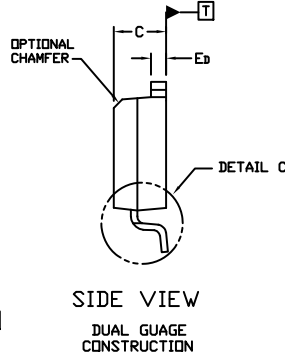
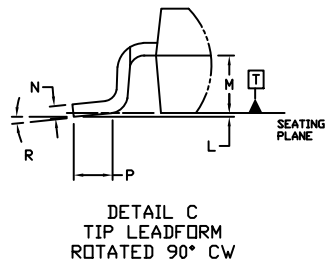
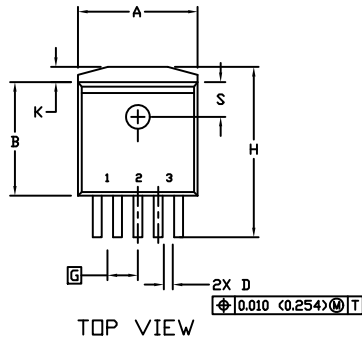

NOTES:

1. DIMENSIONING AND TOLERANCING PER ANSI Y14.5M, 1982.
2. CONTROLLING DIMENSION INCHES
3. TAB CONTOUR OPTIONAL WITHIN DIMENSIONS A AND K.
4. DIMENSIONS U AND V ESTABLISH A MINIMUM MOUNTING SURFACE FOR TERMINAL 4.
5. DIMENSIONS A AND B DO NOT INCLUDE MOLD FLASH OR GATE PROTRUSIONS. MOLD FLASH AND GATE PROTRUSIONS NOT TO EXCEED 0.025 (0.635) MAXIMUM.

DIM	INCHES		MILLIMETERS	
	MIN.	MAX.	MIN.	MAX.
A	0.396	0.403	9.804	10.236
B	0.356	0.368	9.042	9.347
C	0.170	0.180	4.318	4.572
D	0.026	0.036	0.660	0.914
Ed	0.045	0.055	1.143	1.397
Es	0.018	0.026	0.457	0.660
G	0.067	BSC	1.702	BSC
H	0.539	0.579	13.691	14.707
K	0.050	REF	1.270	REF
L	0.000	0.010	0.000	0.254
M	0.088	0.102	2.235	2.591
N	0.018	0.026	0.457	0.660
P	0.058	0.078	1.473	1.981
R	0°	8°	0°	8°
S	0.116	REF	2.946	REF
U	0.200	MIN	5.080	MIN
V	0.250	MIN	6.350	MIN

GENERIC MARKING DIAGRAM*

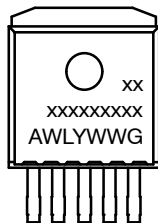

- xxxxxx = Device Code
- A = Assembly Location
- WL = Wafer Lot
- Y = Year
- WW = Work Week
- G = Pb-Free Package

*This information is generic. Please refer to device data sheet for actual part marking. Pb-Free indicator, "G" or microdot "•", may or may not be present. Some products may not follow the Generic Marking.

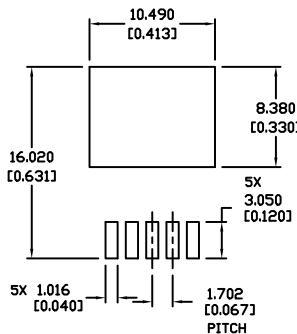

* For additional information on our Pb-Free strategy and soldering details, please download the ON Semiconductor Soldering and Mounting Techniques Reference Manual, SOLDERRM/D.

DOCUMENT NUMBER:	98ASH01006A	Electronic versions are uncontrolled except when accessed directly from the Document Repository. Printed versions are uncontrolled except when stamped "CONTROLLED COPY" in red.
DESCRIPTION:	D2PAK 5-LEAD	PAGE 1 OF 1

ON Semiconductor and are trademarks of Semiconductor Components Industries, LLC dba ON Semiconductor or its subsidiaries in the United States and/or other countries. ON Semiconductor reserves the right to make changes without further notice to any products herein. ON Semiconductor makes no warranty, representation or guarantee regarding the suitability of its products for any particular purpose, nor does ON Semiconductor assume any liability arising out of the application or use of any product or circuit, and specifically disclaims any and all liability, including without limitation special, consequential or incidental damages. ON Semiconductor does not convey any license under its patent rights nor the rights of others.

onsemi, **Onsemi**, and other names, marks, and brands are registered and/or common law trademarks of Semiconductor Components Industries, LLC dba "**onsemi**" or its affiliates and/or subsidiaries in the United States and/or other countries. **onsemi** owns the rights to a number of patents, trademarks, copyrights, trade secrets, and other intellectual property. A listing of **onsemi**'s product/patent coverage may be accessed at www.onsemi.com/site/pdf/Patent-Marking.pdf. **onsemi** reserves the right to make changes at any time to any products or information herein, without notice. The information herein is provided "as-is" and **onsemi** makes no warranty, representation or guarantee regarding the accuracy of the information, product features, availability, functionality, or suitability of its products for any particular purpose, nor does **onsemi** assume any liability arising out of the application or use of any product or circuit, and specifically disclaims any and all liability, including without limitation special, consequential or incidental damages. Buyer is responsible for its products and applications using **onsemi** products, including compliance with all laws, regulations and safety requirements or standards, regardless of any support or applications information provided by **onsemi**. "Typical" parameters which may be provided in **onsemi** data sheets and/or specifications can and do vary in different applications and actual performance may vary over time. All operating parameters, including "Typicals" must be validated for each customer application by customer's technical experts. **onsemi** does not convey any license under any of its intellectual property rights nor the rights of others. **onsemi** products are not designed, intended, or authorized for use as a critical component in life support systems or any FDA Class 3 medical devices or medical devices with a same or similar classification in a foreign jurisdiction or any devices intended for implantation in the human body. Should Buyer purchase or use **onsemi** products for any such unintended or unauthorized application, Buyer shall indemnify and hold **onsemi** and its officers, employees, subsidiaries, affiliates, and distributors harmless against all claims, costs, damages, and expenses, and reasonable attorney fees arising out of, directly or indirectly, any claim of personal injury or death associated with such unintended or unauthorized use, even if such claim alleges that **onsemi** was negligent regarding the design or manufacture of the part. **onsemi** is an Equal Opportunity/Affirmative Action Employer. This literature is subject to all applicable copyright laws and is not for resale in any manner.

ADDITIONAL INFORMATION

TECHNICAL PUBLICATIONS:

Technical Library: www.onsemi.com/design/resources/technical-documentation
onsemi Website: www.onsemi.com

ONLINE SUPPORT: www.onsemi.com/support

For additional information, please contact your local Sales Representative at www.onsemi.com/support/sales