

NCV8504 Series

LDO Linear Regulators - Micropower, DELAY, Adjustable RESET, General Use Comparator

400 mA

The NCV8504 is a family of precision micropower voltage regulators. Their output current capability is 400 mA. The family has output voltage options for Adjustable, 2.5 V, 3.3 V and 5.0 V.

The output voltage is accurate within $\pm 2.0\%$ with a maximum dropout voltage of 0.6 V at 400 mA. Low quiescent current is a feature drawing only 100 μA with a 100 μA load. This part is ideal for any and all battery operated microprocessor equipment.

Microprocessor control logic includes an active $\overline{\text{RESET}}$ (with DELAY).

The active $\overline{\text{RESET}}$ circuit operates correctly at an output voltage as low as 1.0 V. The $\overline{\text{RESET}}$ function is activated during the power up sequence or during normal operation if the output voltage drops below the regulation limits.

The reset threshold voltage can be decreased by the connection of external resistor divider to R_{ADJ} lead.

The general use comparator ($\overline{\text{FLAG}}$ /Monitor) is referenced to a temperature stable voltage and provides 1 mA of drive current at its open collector output.

The regulator is protected against reverse battery, short circuit, and thermal overload conditions. The device can withstand load dump transients making it suitable for use in automotive environments. The device has also been optimized for EMC conditions.

Features

- Output Voltage Options: Adjustable, 2.5 V, 3.3 V, 5.0 V
- $\pm 2.0\%$ Output
- Low 100 μA Quiescent Current
- Fixed or Adjustable Output Voltage
- Active $\overline{\text{RESET}}$
- Adjustable Reset
- 400 mA Output Current Capability
- Fault Protection
 - ◆ +60 V Peak Transient Voltage
 - ◆ -15 V Reverse Voltage
 - ◆ Short Circuit
 - ◆ Thermal Overload
- General Use Comparator
- NCV Prefix for Automotive and Other Applications Requiring Site and Change Control
- AEC Qualified
- PPAP Capable
- These are Pb-Free Devices



ON Semiconductor®

<http://onsemi.com>

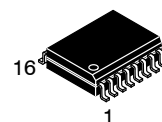

**SOIC 16 LEAD
WIDE BODY
EXPOSED PAD
PDW SUFFIX
CASE 751AG**

MARKING DIAGRAM



- x = Voltage Ratings as Indicated Below:
- A = Adjustable
 - 2 = 2.5 V
 - 3 = 3.3 V
 - 5 = 5.0 V
- A = Assembly Location
WL = Wafer Lot
YY = Year
WW = Work Week
G = Pb-Free Device

ORDERING INFORMATION

See detailed ordering and shipping information in the package dimensions section on page 11 of this data sheet.

NCV8504 Series

PIN CONNECTIONS

ADJUSTABLE OUTPUT

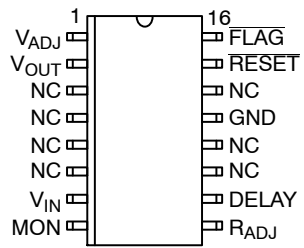

FIXED OUTPUT

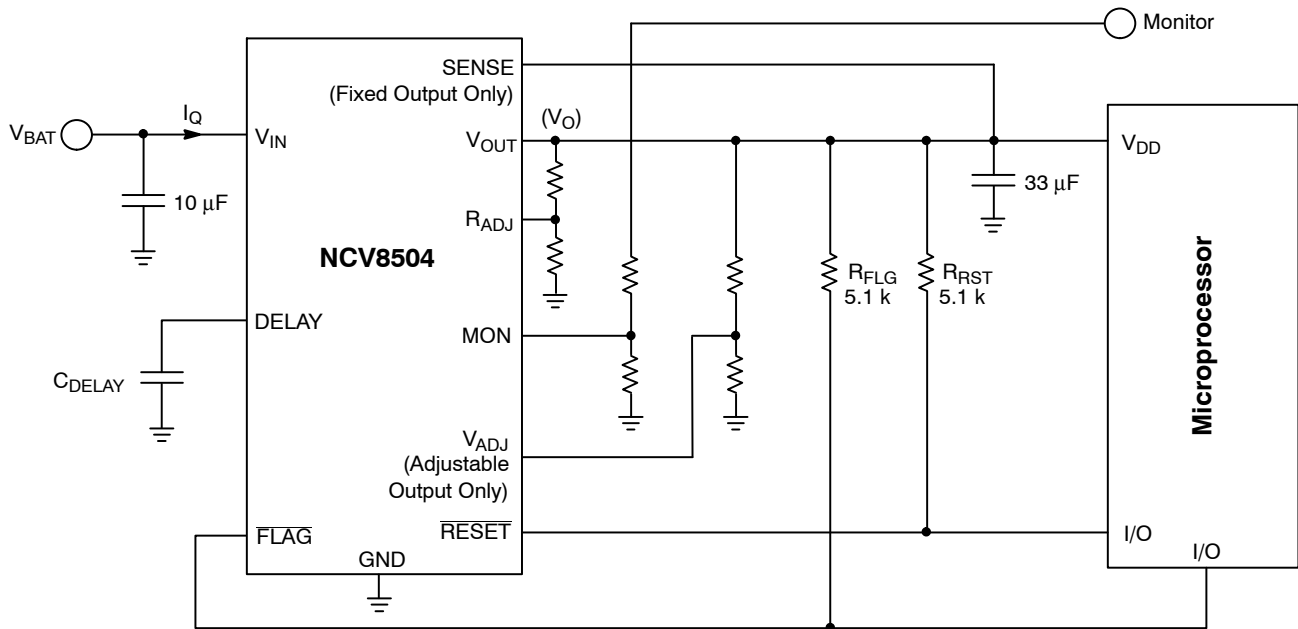
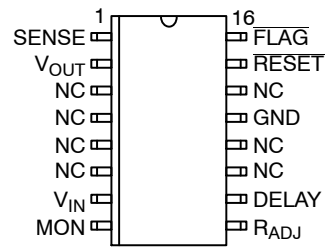

Figure 1. Application Diagram

NCV8504 Series

MAXIMUM RATINGS*†

Rating	Value	Unit
V_{IN} (DC)	-15 to 45	V
Peak Transient Voltage (46 V Load Dump @ $V_{IN} = 14$ V)	60	V
Operating Voltage	45	V
V_{OUT} (DC)	-0.3 to 16	V
Voltage Range (RESET, FLAG, R_{ADJ} , DELAY)	-0.3 to 10	V
Input Voltage Range MON	-0.3 to 10	V
V_{ADJ}	-0.3 to 16	V
ESD Susceptibility (Human Body Model)	4.0	kV
(Machine Model)	200	V
Junction Temperature, T_J	-40 to +150	°C
Storage Temperature, T_S	-55 to 150	°C
Package Thermal Resistance, SOW-16 E PAD: Junction-to-Case, $R_{\theta JC}$	16	°C/W
Junction-to-Ambient, $R_{\theta JA}$	57	°C/W
Lead Temperature Soldering:	Reflow: (SMD styles only) (Note 1) 260 peak (Note 2)	°C

1. 150 second maximum above 217°C.

2. -5°C/+0°C allowable conditions.

*The maximum package power dissipation must be observed.

†During the voltage range which exceeds the maximum tested voltage of V_{IN} , operation is assured, but not specified. Wider limits may apply. Thermal dissipation must be observed closely.

ELECTRICAL CHARACTERISTICS ($I_{OUT} = 1.0$ mA, $-40^{\circ}\text{C} \leq T_J \leq 150^{\circ}\text{C}$; V_{IN} = dependent on voltage option (Note 3);

unless otherwise specified.)

Characteristic	Test Conditions	Min	Typ	Max	Unit
Output Stage					
Output Voltage for 2.5 V Option (V_O)	$6.5\text{ V} < V_{IN} < 16\text{ V}$, $1.0\text{ mA} \leq I_{OUT} \leq 400\text{ mA}$	2.450	2.5	2.550	V
	$4.5\text{ V} < V_{IN} < 26\text{ V}$, $1.0\text{ mA} \leq I_{OUT} \leq 400\text{ mA}$	2.425	2.5	2.575	V
Output Voltage for 3.3 V Option (V_O)	$7.3\text{ V} < V_{IN} < 16\text{ V}$, $1.0\text{ mA} \leq I_{OUT} \leq 400\text{ mA}$	3.234	3.3	3.366	V
	$4.5\text{ V} < V_{IN} < 26\text{ V}$, $1.0\text{ mA} \leq I_{OUT} \leq 400\text{ mA}$	3.201	3.3	3.399	V
Output Voltage for 5.0 V Option (V_O)	$9.0\text{ V} < V_{IN} < 16\text{ V}$, $1.0\text{ mA} \leq I_{OUT} \leq 400\text{ mA}$	4.90	5.0	5.10	V
	$6.0\text{ V} < V_{IN} < 26\text{ V}$, $1.0\text{ mA} \leq I_{OUT} \leq 400\text{ mA}$	4.85	5.0	5.15	V
Output Voltage for Adjustable Option (V_O)	$V_{OUT} = V_{ADJ}$ (Unity Gain)				
	$6.5\text{ V} < V_{IN} < 16\text{ V}$, $1.0\text{ mA} < I_{OUT} < 400\text{ mA}$	1.274	1.300	1.326	V
	$4.5\text{ V} < V_{IN} < 26\text{ V}$, $1.0\text{ mA} < I_{OUT} < 400\text{ mA}$	1.261	1.306	1.339	V
Dropout Voltage ($V_{IN} - V_{OUT}$) (5.0 V and Adj. > 5.0 V Options Only)	$I_{OUT} = 400\text{ mA}$	-	400	600	mV
	$I_{OUT} = 1.0\text{ mA}$	-	30	150	mV
Load Regulation	$V_{IN} = 14\text{ V}$, $5.0\text{ mA} \leq I_{OUT} \leq 400\text{ mA}$	-30	5.0	30	mV
Line Regulation (2.5 V, 3.3 V, and Adjustable Options)	$4.5\text{ V} < V_{IN} < 26\text{ V}$, $I_{OUT} = 1.0\text{ mA}$	-	5.0	25	mV
Line Regulation (5.0 V Option)	$6.0\text{ V} < V_{IN} < 26\text{ V}$, $I_{OUT} = 1.0\text{ mA}$	-	5.0	25	mV
Quiescent Current, (I_Q) Active Mode	$I_{OUT} = 100\text{ }\mu\text{A}$, $V_{IN} = 12\text{ V}$, Delay = 3.0 V, MON = 3.0 V	-	100	150	μA
	$I_{OUT} = 75\text{ mA}$, $V_{IN} = 14\text{ V}$, Delay = 3.0 V, MON = 3.0 V	-	2.5	5.0	mA
	$I_{OUT} \leq 400\text{ mA}$, $V_{IN} = 14\text{ V}$, Delay = 3.0 V, MON = 3.0 V	-	25	45	mA
Current Limit	-	425	800	-	mA
Short Circuit Output Current	$V_{OUT} = 0\text{ V}$	100	500	-	mA
Thermal Shutdown	(Guaranteed by Design)	150	180	-	°C

3. Voltage range specified in the Output Stage of the Electrical Characteristics in boldface type.

NCV8504 Series

ELECTRICAL CHARACTERISTICS (continued) ($I_{OUT} = 1.0 \text{ mA}$, $-40^{\circ}\text{C} \leq T_J \leq 150^{\circ}\text{C}$; V_{IN} = dependent on voltage option (Note 4); unless otherwise specified.)

Characteristic	Test Conditions	Min	Typ	Max	Unit
Reset Function (RESET)					
RESET Threshold for 2.5 V Option HIGH (V_{RH}) LOW (V_{RL}) Hysteresis	$V_{IN} = 4.5 \text{ V}$ (Note 5) (Note 6) V_{OUT} Increasing V_{OUT} Decreasing	2.35 2.30 25	– – –	$1.0 \times V_O$ – –	V V mV
RESET Threshold for 3.3 V Option HIGH (V_{RH}) LOW (V_{RL}) Hysteresis	$V_{IN} = 4.5 \text{ V}$ (Note 5) (Note 6) V_{OUT} Increasing V_{OUT} Decreasing	3.10 3.00 35	– – –	$1.0 \times V_O$ – –	V V mV
RESET Threshold for 5.0 V Option HIGH (V_{RH}) LOW (V_{RL}) Hysteresis	$V_{IN} = 6.0 \text{ V}$ (Note 6) V_{OUT} Increasing V_{OUT} Decreasing	4.70 4.60 50	– – –	$1.0 \times V_O$ – –	V V mV
RESET Threshold for Adjustable Option HIGH (V_{RH}) LOW (V_{RL}) Hysteresis	$V_{IN} = 4.5 \text{ V}$ (Note 5) (Note 6) V_{OUT} Increasing V_{OUT} Decreasing	1.22 1.19 10	– – –	$1.0 \times V_O$ – –	V V mV
RESET Output Voltage Low (V_{RLO})	$V_{IN} = \text{Minimum}$ (Note 6) (Note 7) $1.0 \text{ V} \leq V_{OUT} \leq V_{RL}$, $R_{RESET} = 5.1 \text{ k}$	–	0.1	0.4	V
DELAY Switching Threshold (V_{DT}) (2.5 V, 3.3 V, and 5.0 V Options)	$V_{IN} = \text{Minimum}$ (Note 6) (Note 7)	1.4	1.8	2.2	V
DELAY Switching Threshold (V_{DT}) (Adjustable Option)	$V_{IN} = \text{Minimum}$ (Note 6) (Note 7)	1.0	1.3	1.6	V
DELAY Low Voltage	$V_{IN} = \text{Minimum}$ (Note 6) (Note 7) $V_{OUT} < \text{RESET Threshold Low}(\text{min})$	–	–	0.2	V
DELAY Charge Current	$V_{IN} = \text{Minimum}$ (Note 6) (Note 7) DELAY = 1.0 V, $V_{OUT} > V_{RH}$	2.5	4.0	5.5	μA
DELAY Discharge Current	$V_{IN} = \text{Minimum}$ (Note 6) (Note 7) DELAY = 1.0 V, $V_{OUT} < V_{RL}$	5.0	–	–	mA
Reset Adjust Switching Voltage ($V_{R(ADJ)}$) Hysteresis	$V_{IN} = \text{Minimum}$ (Note 6) (Note 7) Increasing and Decreasing	1.16 20	1.25 50	1.34 100	V mV

FLAG/Monitor

Monitor Threshold	Increasing and Decreasing, $V_{IN} = \text{Minimum}$ (Note 6) (Note 7)	1.22	1.29	1.36	V
Hysteresis	$V_{IN} = \text{Minimum}$ (Note 6) (Note 7)	10	35	75	mV
Input Current	MON = 2.0 V	–1.0	0.1	1.0	μA
Output Saturation Voltage	MON = 0 V, $I_{FLAG} = 1.0 \text{ mA}$, $V_{IN} = \text{Minimum}$ (Note 6) (Note 7)	–	0.1	0.4	V

Voltage Adjust (Adjustable Output only)

Input Current	$V_{ADJ} = 1.25 \text{ V}$	–0.5	–	0.5	μA
---------------	----------------------------	------	---	-----	---------------

4. Voltage range specified in the Output Stage of the Electrical Characteristics in boldface type.
5. For $V_{IN} \leq 4.5 \text{ V}$, a RESET = Low may occur with the output in regulation.
6. Part is guaranteed by design to meet specification over the entire V_{IN} voltage range, but is production tested only at the specified V_{IN} voltage.
7. Minimum $V_{IN} = 4.5 \text{ V}$ for 2.5 V, 3.3 V, and Adjustable options. Minimum $V_{IN} = 6.0 \text{ V}$ for 5.0 V option.

NCV8504 Series

PACKAGE PIN DESCRIPTION, ADJUSTABLE OUTPUT

Pin Number	Pin Symbol	Function
1	V _{ADJ}	Voltage Adjust. A resistor divider from V _{OUT} to this lead sets the output voltage.
2	V _{OUT}	±2.0%, 400 mA output.
3-6, 11, 12, 14	NC	No connection.
7	V _{IN}	Input Voltage.
8	MON	Monitor. Input to comparator. If not needed connect to V _{OUT} .
9	R _{ADJ}	Reset Adjust. If not needed connect to ground.
10	DELAY	Timing capacitor for $\overline{\text{RESET}}$ function.
13	GND	Ground. All GND leads must be connected to Ground.
15	RESET	Active reset (accurate to V _{OUT} ≥ 1.0 V)
16	FLAG	Open collector output from comparator.

NOTE: Tentative pinout for SOW-16 E Pad.

PACKAGE PIN DESCRIPTION, FIXED OUTPUT

Pin Number	Pin Symbol	Function
1	SENSE	Kelvin connection which allows remote sensing of output voltage for improved regulation. If remote sensing is not desired, connect to V _{OUT} .
2	V _{OUT}	±2.0%, 400 mA output.
3-6, 11, 12, 14	NC	No connection.
7	V _{IN}	Input Voltage.
8	MON	Monitor. Input to comparator. If not needed connect to V _{OUT} .
9	R _{ADJ}	Reset Adjust. If not needed connect to ground.
10	DELAY	Timing capacitor for $\overline{\text{RESET}}$ function.
13	GND	Ground. All GND leads must be connected to Ground.
15	RESET	Active reset (accurate to V _{OUT} ≥ 1.0 V)
16	FLAG	Open collector output from comparator.

NOTE: Tentative pinout for SOW-16 E Pad.

NCV8504 Series

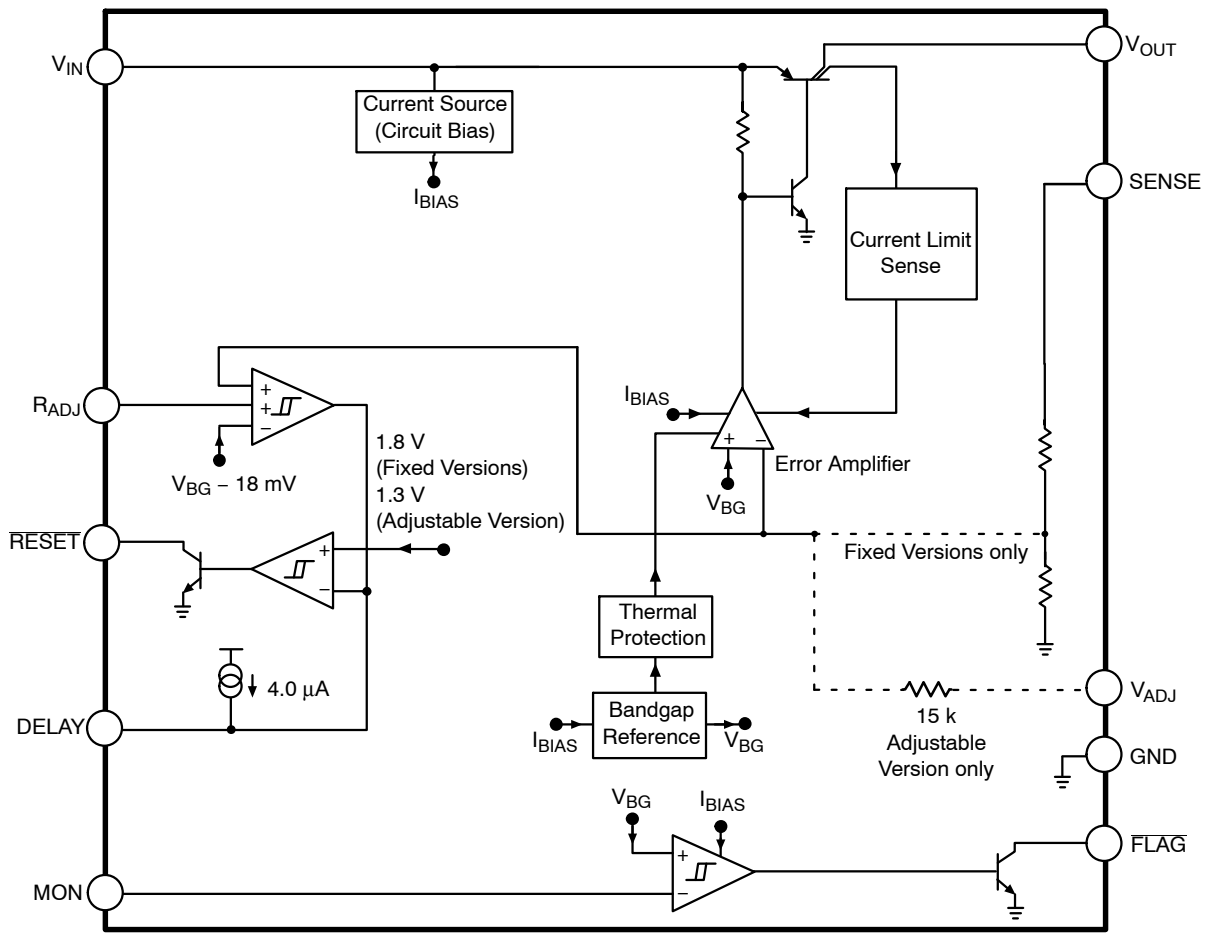

Figure 2. Block Diagram

TYPICAL PERFORMANCE CHARACTERISTICS

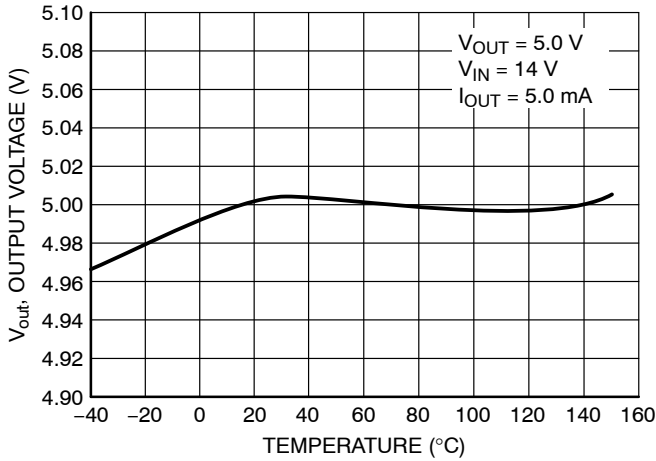

Figure 3. 5 V Output Voltage vs Temperature

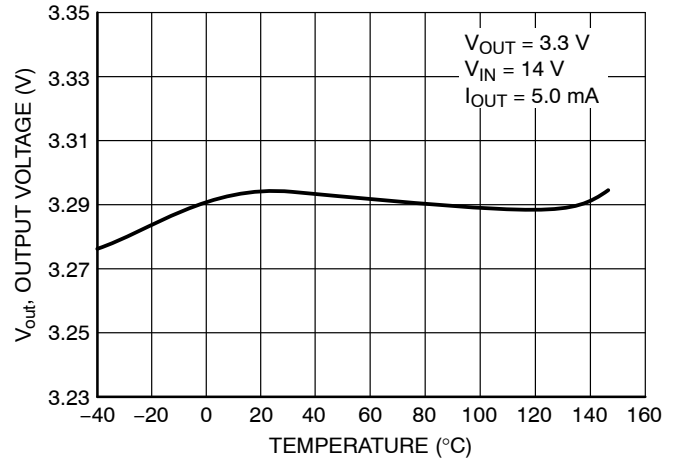

Figure 4. 3.3 V Output Voltage vs Temperature

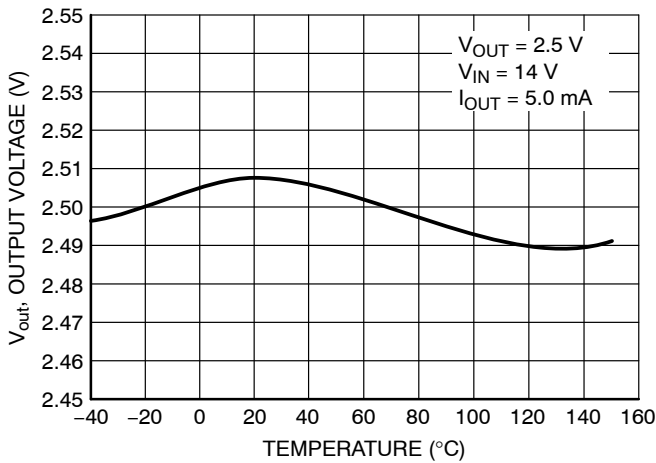

Figure 5. 2.5 V Output Voltage vs Temperature

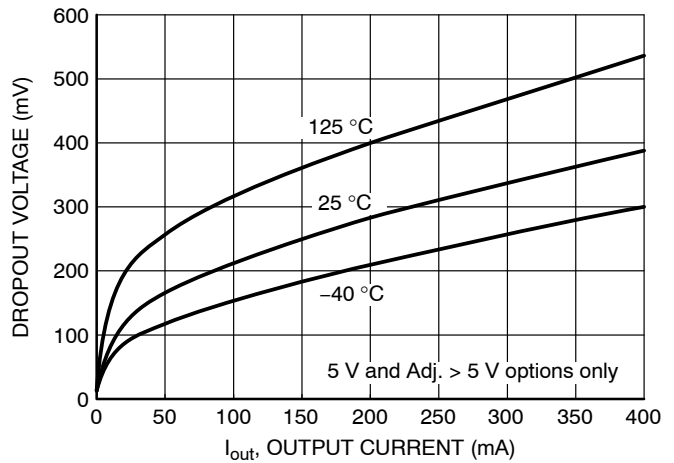

Figure 6. Dropout Voltage vs Output Current

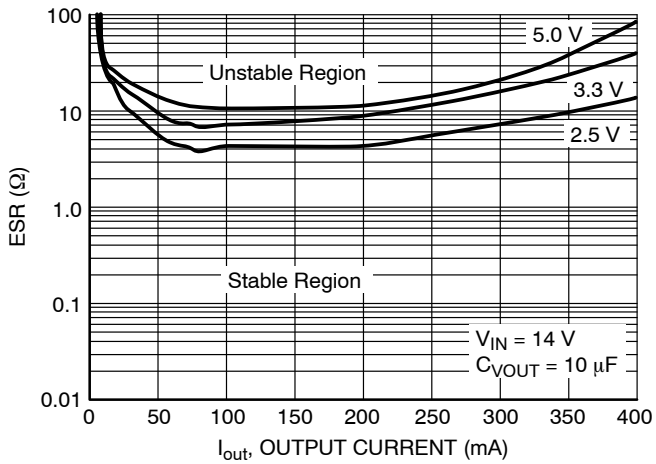

Figure 7. Output Stability with Output Voltage Change

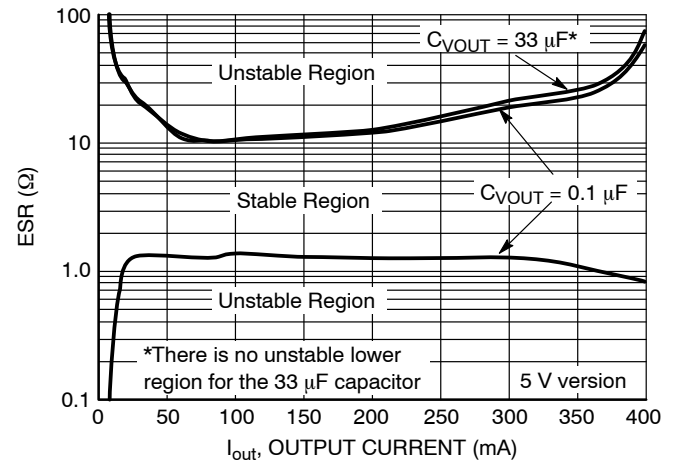

Figure 8. Output Stability with Output Capacitor Change

NCV8504 Series

TYPICAL PERFORMANCE CHARACTERISTICS

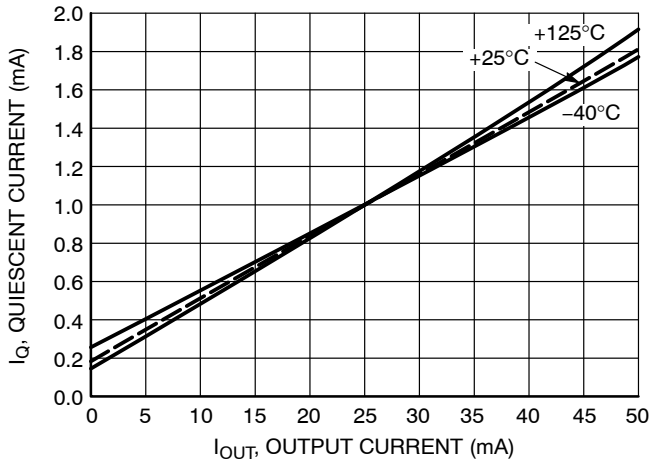

Figure 9. Quiescent Current vs Output Current

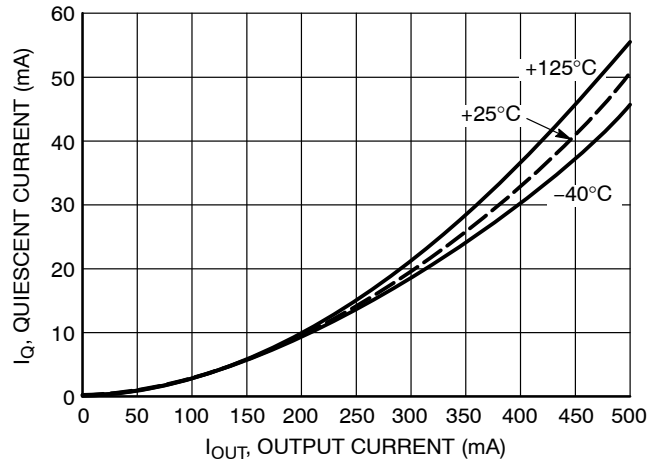

Figure 10. Quiescent Current vs Output Current

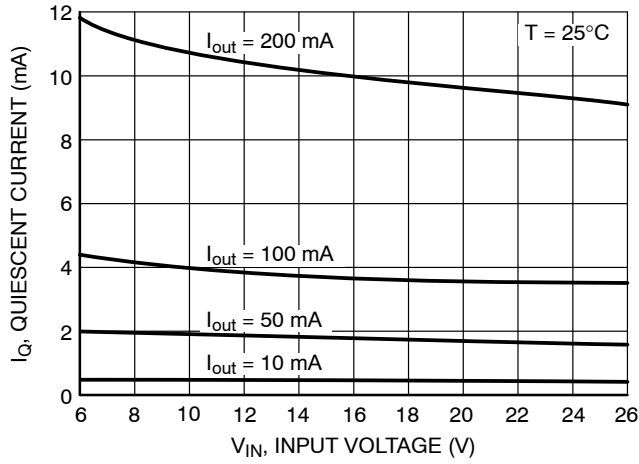

Figure 11. Quiescent Current vs Input Voltage

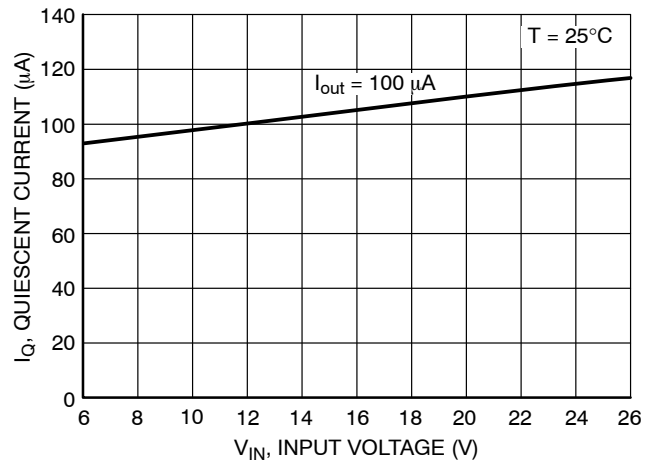

Figure 12. Quiescent Current vs Input Voltage

CIRCUIT DESCRIPTION

REGULATOR CONTROL FUNCTIONS

The NCV8504 contains the microprocessor compatible control function $\overline{\text{RESET}}$ (Figure 13).

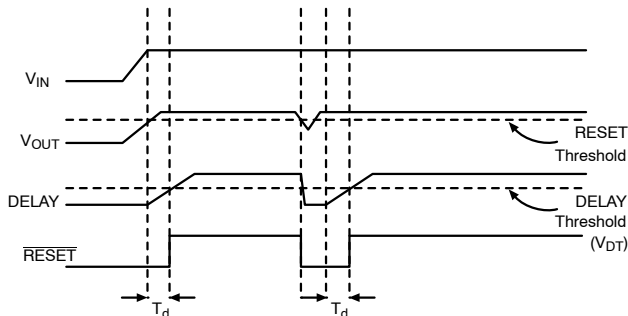

Figure 13. Reset and Delay Circuit Wave Forms

$\overline{\text{RESET}}$ Function

A $\overline{\text{RESET}}$ signal (low voltage) is generated as the IC powers up until V_{OUT} is within 1.5% of the regulated output voltage, or when V_{OUT} drops out of regulation, and is lower than 4.0% below the regulated output voltage. Hysteresis is included in the function to minimize oscillations.

The $\overline{\text{RESET}}$ output is an open collector NPN transistor, controlled by a low voltage detection circuit. The circuit is functionally independent of the rest of the IC thereby guaranteeing that the $\overline{\text{RESET}}$ signal is valid for V_{OUT} as low as 1.0 V.

Adjustable Reset Function

The reset threshold can be made lower by connecting an external resistor divider to the R_{ADJ} lead from the V_{OUT} lead, as displayed in Figure 14. This lead is grounded to select the default value of 4.6 V (on the 5.0 V option).

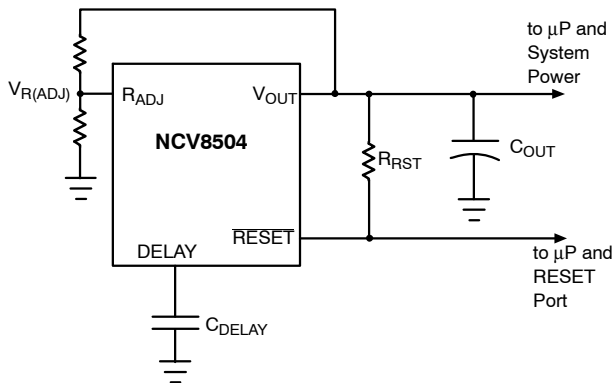

Figure 14. Adjustable $\overline{\text{RESET}}$

DELAY Function

The reset delay circuit provides a programmable (by external capacitor) delay on the $\overline{\text{RESET}}$ output lead.

The DELAY lead provides source current (typically 4.0 μA) to the external DELAY capacitor during the following proceedings:

1. During Power Up (once the regulation threshold has been verified).
2. After a reset event has occurred and the device is back in regulation. The DELAY capacitor is discharged when the regulation ($\overline{\text{RESET}}$ threshold) has been violated. This is a latched incident. The capacitor will fully discharge and wait for the device to regulate before going through the delay time event again.

FLAG/Monitor Comparator

A general use comparator is included whose positive input terminal is tied to the on-chip bandgap voltage reference. This provides a very temperature stable referenced comparator with versatile use in any system. The trip point can be programmed externally using a resistor divider to the input monitor (MON) (Figure 15). The typical threshold is 1.29 V on the MON pin.

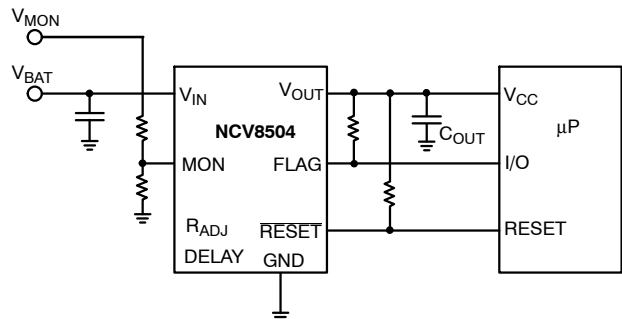

Figure 15. Flag/Monitor Function

Voltage Adjust

Figure 16 shows the device setup for a user configurable output voltage. The feedback to the V_{ADJ} pin is taken from a voltage divider referenced to the output voltage. The loop is balanced around the Unity Gain threshold (1.30 V typical).

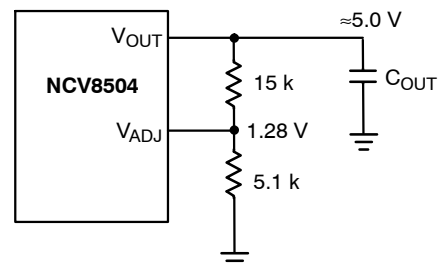

Figure 16. Adjustable Output Voltage

APPLICATION NOTES

FLAG MONITOR

Figure 17 shows the FLAG Monitor waveforms as a result of the circuit depicted in Figure 15. As the input voltage falls (V_{MON}), the Monitor threshold is crossed. This causes the voltage on the FLAG output to go low.

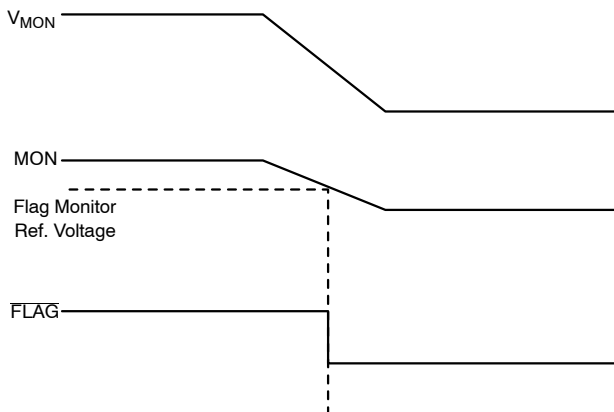

Figure 17. FLAG Monitor Circuit Waveform

SETTING THE DELAY TIME

The delay time is controlled by the Reset Delay Low Voltage, Delay Switching Threshold, and the Delay Charge Current. The delay follows the equation:

$$t_{DELAY} = \frac{[C_{DELAY}(V_{dt} - \text{Reset Delay Low Voltage})]}{\text{Delay Charge Current}}$$

Example:

Using $C_{DELAY} = 33 \text{ nF}$.

Assume reset Delay Low Voltage = 0.

Use the typical value for $V_{dt} = 1.8 \text{ V}$ (2.5 V, 3.3 V, and 5.0 V options).

Use the typical value for Delay Charge Current = $4.2 \mu\text{A}$.

$$t_{DELAY} = \frac{[33 \text{ nF}(1.8 - 0)]}{4.2 \mu\text{A}} = 14 \text{ ms}$$

STABILITY CONSIDERATIONS

The output or compensation capacitor helps determine three main characteristics of a linear regulator: start-up delay, load transient response and loop stability.

The capacitor value and type should be based on cost, availability, size and temperature constraints. A tantalum or aluminum electrolytic capacitor is best, since a film or ceramic capacitor with almost zero ESR can cause instability. The aluminum electrolytic capacitor is the least expensive solution, but, if the circuit operates at low temperatures (-25°C to -40°C), both the value and ESR of the capacitor will vary considerably. The capacitor manufacturers data sheet usually provides this information.

The value for the output capacitor C_{OUT} shown in Figure 18 should work for most applications, however it is not necessarily the optimized solution.

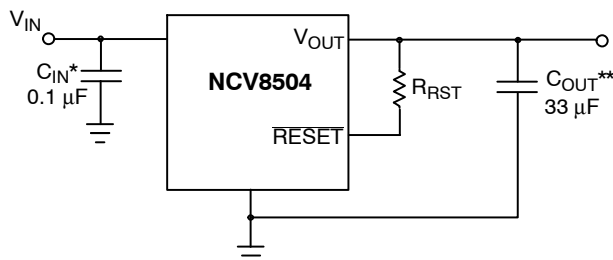

* C_{IN} required if regulator is located far from the power supply filter
 ** C_{OUT} required for stability. Capacitor must operate at minimum temperature expected

Figure 18. Test and Application Circuit Showing Output Compensation

CALCULATING POWER DISSIPATION IN A SINGLE OUTPUT LINEAR REGULATOR

The maximum power dissipation for a single output regulator (Figure 19) is:

$$P_{D(max)} = [V_{IN(max)} - V_{OUT(min)}]I_{OUT(max)} + V_{IN(max)}I_Q \quad (1)$$

where:

$V_{IN(max)}$ is the maximum input voltage,

$V_{OUT(min)}$ is the minimum output voltage,

$I_{OUT(max)}$ is the maximum output current for the application, and

I_Q is the quiescent current the regulator consumes at $I_{OUT(max)}$.

Once the value of $P_{D(max)}$ is known, the maximum permissible value of $R_{\theta JA}$ can be calculated:

$$R_{\theta JA} = \frac{150^{\circ}\text{C} - T_A}{P_D} \quad (2)$$

The value of $R_{\theta JA}$ can then be compared with those in the package section of the data sheet. Those packages with $R_{\theta JA}$'s less than the calculated value in equation 2 will keep the die temperature below 150°C .

In some cases, none of the packages will be sufficient to dissipate the heat generated by the IC, and an external heatsink will be required.

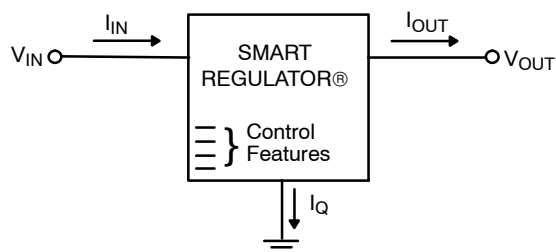

Figure 19. Single Output Regulator with Key Performance Parameters Labeled

NCV8504 Series

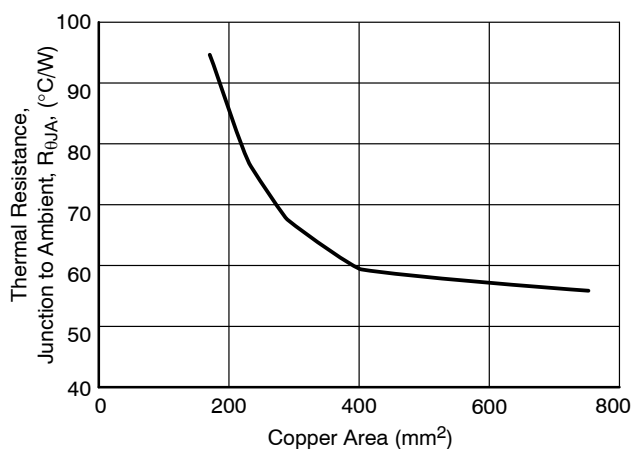

Figure 20.16 Lead SOW (Exposed Pad), θ_{JA} as a Function of the Pad Copper Area (2 oz. Cu Thickness), Board Material = 0.0625" G-10/R-4

HEAT SINKS

A heat sink effectively increases the surface area of the package to improve the flow of heat away from the IC and into the surrounding air.

Each material in the heat flow path between the IC and the outside environment will have a thermal resistance. Like series electrical resistances, these resistances are summed to determine the value of $R_{\theta JA}$:

$$R_{\theta JA} = R_{\theta JC} + R_{\theta CS} + R_{\theta SA} \quad (3)$$

where:

$R_{\theta JC}$ = the junction-to-case thermal resistance,
 $R_{\theta CS}$ = the case-to-heat sink thermal resistance, and
 $R_{\theta SA}$ = the heat sink-to-ambient thermal resistance.

$R_{\theta JC}$ appears in the package section of the data sheet. Like $R_{\theta JA}$, it too is a function of package type. $R_{\theta CS}$ and $R_{\theta SA}$ are functions of the package type, heat sink and the interface between them. These values appear in heat sink data sheets of heat sink manufacturers.

ORDERING INFORMATION

Device	Output Voltage	Package	Shipping†
NCV8504PWADJG	Adjustable	SOW-16 Exposed Pad (Pb-Free)	47 Units/Rail
NCV8504PWADJR2G		SOW-16 Exposed Pad (Pb-Free)	1000 Tape & Reel
NCV8504PW25G	2.5 V	SOW-16 Exposed Pad (Pb-Free)	47 Units/Rail
NCV8504PW25R2G		SOW-16 Exposed Pad (Pb-Free)	1000 Tape & Reel
NCV8504PW33G	3.3 V	SOW-16 Exposed Pad (Pb-Free)	47 Units/Rail
NCV8504PW33R2G		SOW-16 Exposed Pad (Pb-Free)	1000 Tape & Reel
NCV8504PW50G	5.0 V	SOW-16 Exposed Pad (Pb-Free)	47 Units/Rail
NCV8504PW50R2G		SOW-16 Exposed Pad (Pb-Free)	1000 Tape & Reel

†For information on tape and reel specifications, including part orientation and tape sizes, please refer to our Tape and Reel Packaging Specification Brochure, BRD8011/D.

MECHANICAL CASE OUTLINE

PACKAGE DIMENSIONS

ON Semiconductor®

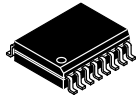

SOIC 16 LEAD WIDE BODY, EXPOSED PAD CASE 751AG ISSUE B

DATE 31 MAY 2016

SCALE 1:1

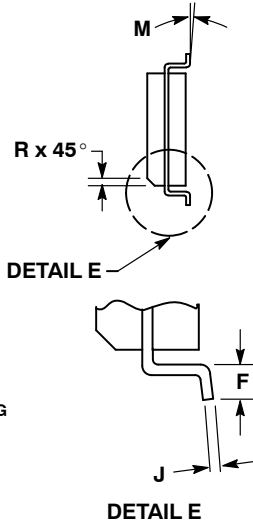
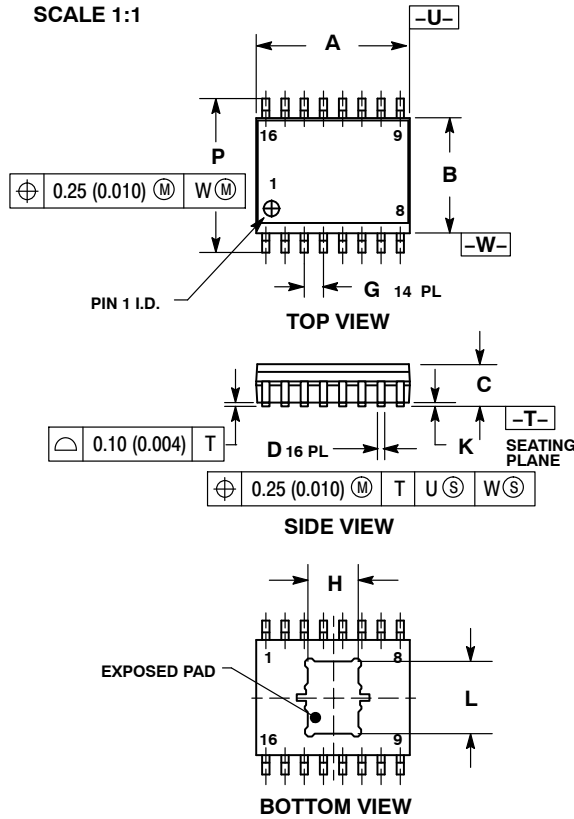

NOTES:

1. DIMENSIONING AND TOLERANCING PER ANSI Y14.5M, 1982.
2. CONTROLLING DIMENSION: MILLIMETER.
3. DIMENSION A AND B DO NOT INCLUDE MOLD PROTRUSION.
4. MAXIMUM MOLD PROTRUSION 0.15 (0.006) PER SIDE.
5. DIMENSION D DOES NOT INCLUDE DAMBAR PROTRUSION. ALLOWABLE PROTRUSION SHALL BE 0.13 (0.005) TOTAL IN EXCESS OF THE D DIMENSION AT MAXIMUM MATERIAL CONDITION.
6. 751R-01 OBSOLETE, NEW STANDARD 751R-02.

DIM	MILLIMETERS		INCHES	
	MIN	MAX	MIN	MAX
A	10.15	10.45	0.400	0.411
B	7.40	7.60	0.292	0.299
C	2.35	2.65	0.093	0.104
D	0.35	0.49	0.014	0.019
F	0.50	0.90	0.020	0.035
G	1.27 BSC		0.050 BSC	
H	3.45	3.66	0.136	0.144
J	0.25	0.32	0.010	0.012
K	0.00	0.10	0.000	0.004
L	4.72	4.93	0.186	0.194
M	0°	7°	0°	7°
P	10.05	10.55	0.395	0.415
R	0.25	0.75	0.010	0.029

GENERIC MARKING DIAGRAM*

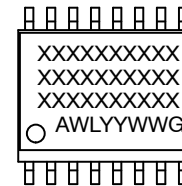

- XXXXXX = Specific Device Code
- A = Assembly Location
- WL = Wafer Lot
- YY = Year
- WW = Work Week
- G = Pb-Free Package

*This information is generic. Please refer to device data sheet for actual part marking. Pb-Free indicator, "G" or microdot "▪", may or may not be present.

SOLDERING FOOTPRINT*

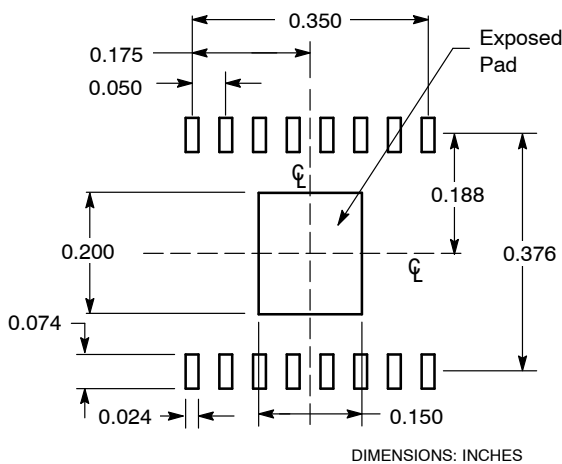

*For additional information on our Pb-Free strategy and soldering details, please download the ON Semiconductor Soldering and Mounting Techniques Reference Manual, SOLDERRM/D.

DOCUMENT NUMBER:	98AON21237D	Electronic versions are uncontrolled except when accessed directly from the Document Repository. Printed versions are uncontrolled except when stamped "CONTROLLED COPY" in red.
DESCRIPTION:	SOIC-16, WB EXPOSED PAD	PAGE 1 OF 1

ON Semiconductor and are trademarks of Semiconductor Components Industries, LLC dba ON Semiconductor or its subsidiaries in the United States and/or other countries. ON Semiconductor reserves the right to make changes without further notice to any products herein. ON Semiconductor makes no warranty, representation or guarantee regarding the suitability of its products for any particular purpose, nor does ON Semiconductor assume any liability arising out of the application or use of any product or circuit, and specifically disclaims any and all liability, including without limitation special, consequential or incidental damages. ON Semiconductor does not convey any license under its patent rights nor the rights of others.

onsemi, **Onsemi**, and other names, marks, and brands are registered and/or common law trademarks of Semiconductor Components Industries, LLC dba "**onsemi**" or its affiliates and/or subsidiaries in the United States and/or other countries. **onsemi** owns the rights to a number of patents, trademarks, copyrights, trade secrets, and other intellectual property. A listing of **onsemi**'s product/patent coverage may be accessed at www.onsemi.com/site/pdf/Patent-Marking.pdf. **onsemi** reserves the right to make changes at any time to any products or information herein, without notice. The information herein is provided "as-is" and **onsemi** makes no warranty, representation or guarantee regarding the accuracy of the information, product features, availability, functionality, or suitability of its products for any particular purpose, nor does **onsemi** assume any liability arising out of the application or use of any product or circuit, and specifically disclaims any and all liability, including without limitation special, consequential or incidental damages. Buyer is responsible for its products and applications using **onsemi** products, including compliance with all laws, regulations and safety requirements or standards, regardless of any support or applications information provided by **onsemi**. "Typical" parameters which may be provided in **onsemi** data sheets and/or specifications can and do vary in different applications and actual performance may vary over time. All operating parameters, including "Typicals" must be validated for each customer application by customer's technical experts. **onsemi** does not convey any license under any of its intellectual property rights nor the rights of others. **onsemi** products are not designed, intended, or authorized for use as a critical component in life support systems or any FDA Class 3 medical devices or medical devices with a same or similar classification in a foreign jurisdiction or any devices intended for implantation in the human body. Should Buyer purchase or use **onsemi** products for any such unintended or unauthorized application, Buyer shall indemnify and hold **onsemi** and its officers, employees, subsidiaries, affiliates, and distributors harmless against all claims, costs, damages, and expenses, and reasonable attorney fees arising out of, directly or indirectly, any claim of personal injury or death associated with such unintended or unauthorized use, even if such claim alleges that **onsemi** was negligent regarding the design or manufacture of the part. **onsemi** is an Equal Opportunity/Affirmative Action Employer. This literature is subject to all applicable copyright laws and is not for resale in any manner.

ADDITIONAL INFORMATION

TECHNICAL PUBLICATIONS:

Technical Library: www.onsemi.com/design/resources/technical-documentation
onsemi Website: www.onsemi.com

ONLINE SUPPORT: www.onsemi.com/support

For additional information, please contact your local Sales Representative at www.onsemi.com/support/sales