

# Enhancement Mode Gallium Nitride (GaN) HEMT

700 V, 132 mΩ, 12 A, PDSO-E3 (DPAK)

## NTD170N70GN1

### Features

- Low  $R_{DS(ON)}$  to Minimize Conduction Losses
- Ultra Low Gate Charge for High Speed Switching
- $FOM-Q_G = 280 \text{ nC} \cdot \text{m}\Omega$
- Small Footprint for High Density PCB Design
- This Device is Pb-Free, Halide Free and is RoHS Compliant

### Typical Applications

- High Density Power Modules
- High Frequency AC-DC and DC-DC Converters
- High Performance PSU for Consumer and Industrial
- Resonant Conversion

### MAXIMUM RATINGS ( $T_J = 25 \text{ }^\circ\text{C}$ unless otherwise noted)

Parameter	Symbol	Value	Unit
Drain-to-Source Voltage	$V_{DSS}$	700	V
Drain-to-Source Transient Voltage, $t_p < 200 \text{ } \mu\text{s}$	$V_{DS(TRAN)}$	800	V
Pulsed Drain-to-Source Voltage, $T_J = 25 \text{ }^\circ\text{C}$ ( $t_{TOTAL} < 10\text{h}$ ) / $T_J = 125 \text{ }^\circ\text{C}$ ( $t_{TOTAL} < 1\text{h}$ )	$V_{DS(PULSE)}$	750	V
Gate-to-Source Voltage	$V_{GS}$	-6 to 7	V
Gate-to-Source Transient Voltage, $t_p = 50 \text{ ns}$ , $f_p = 100 \text{ kHz}$ , Open Drain	$V_{GS(PULSE)}$	-20 to 10	V
Continuous Drain Current, $T_{CASE} = 25 \text{ }^\circ\text{C}$	$I_{DS}$	12	A
Pulsed Drain Current, $t_p < 10 \text{ } \mu\text{s}$ , $T_C = 25 \text{ }^\circ\text{C}$ , $T_C = 125 \text{ }^\circ\text{C}$	$I_{DS(PULSE)}$	24 13	A
Power Dissipation, $V_{GS} = 6 \text{ V}$ , $T_{CASE} = 25 \text{ }^\circ\text{C}$	$P_{TOT}$	64	W
Operating Junction Temperature	$T_J$	-55 to 150	$^\circ\text{C}$
Storage Temperature	$T_{STG}$	-55 to 150	$^\circ\text{C}$

Stresses exceeding those listed in the Maximum Ratings table may damage the device. If any of these limits are exceeded, device functionality should not be assumed, damage may occur and reliability may be affected.

### THERMAL CHARACTERISTICS

Parameter	Symbol	Value	Unit
Junction-to-Case	$R_{\theta JC}$	1.94	$^\circ\text{C}/\text{W}$
Junction-to-Ambient	$R_{\theta JA}$	55.5	$^\circ\text{C}/\text{W}$
Maximum Soldering Temperature (MSL3)	$T_{SLD}$	260	$^\circ\text{C}$

1. Device on 1 in<sup>2</sup>, 2 oz copper pad on single layer FR-4 PCB

$V_{(BR)DSS}$	$R_{DS(ON)}$ TYP	$I_D$ MAX
700 V	132 mΩ	12 A

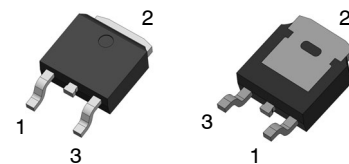
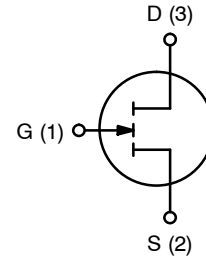

PDSO-E3 6.10x6.60x2.30, 2.28P (DPAK) CASE 209AA

### MARKING DIAGRAM

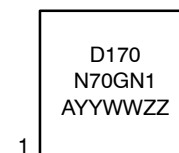

D170N70GN1 = Specific Device Code  
A = Assembly Location  
YY = Year  
WW = Work Week  
ZZ = Assembly Lot Code

### ORDERING INFORMATION

Device	Package	Shipping†
NTD170N70GN1TXG	PDSO-E3 (DPAK)	2500 / Tape & Reel

† For information on tape and reel specifications, including part orientation and tape sizes, please refer to our Tape and Reel Packaging Specification Brochure, [BRD8011/D](#).

# NTD170N70GN1

## ELECTRICAL CHARACTERISTICS ( $T_J = 25\text{ }^\circ\text{C}$ unless otherwise noted)

Parameter	Symbol	Test Condition	Min	Typ	Max	Unit
-----------	--------	----------------	-----	-----	-----	------

### OFF CHARACTERISTICS

Drain-to-Source Breakdown Voltage	$V_{(BR)DSS}$	$V_{GS} = 0\text{ V}$	700			V
Drain-to-Source Leakage Current	$I_{DSS}$	$V_{GS} = 0\text{ V}, V_{DS} = 700\text{ V}$		0.5	28	$\mu\text{A}$
		$V_{GS} = 0\text{ V}, V_{DS} = 700\text{ V}, T_J = 125\text{ }^\circ\text{C}$		5.3		
Gate-to-Source Leakage Current	$I_{GSS}$	$V_{GS} = 6\text{ V}, V_{DS} = 0\text{ V}$		26		$\mu\text{A}$

### ON CHARACTERISTICS

Drain-to-Source On Resistance	$R_{DS(ON)}$	$V_{GS} = 6\text{ V}, I_{DS} = 0.5\text{ A}$		132	170	m $\Omega$
		$V_{GS} = 6\text{ V}, I_{DS} = 4\text{ A}$		132		
		$V_{GS} = 6\text{ V}, I_{DS} = 4\text{ A}, T_J = 125\text{ }^\circ\text{C}$		254		
Gate Threshold Voltage	$V_{GS(TH)}$	$V_{DS} = V_{GS}, I_{DS} = 10.7\text{ mA}, T_J = 25\text{ }^\circ\text{C}$	1.2	1.6	2.5	V
		$V_{DS} = V_{GS}, I_{DS} = 10.7\text{ mA}, T_J = 125\text{ }^\circ\text{C}$		1.5		

### DYNAMIC CHARACTERISTICS

Input Capacitance	$C_{ISS}$	$V_{DS} = 400\text{ V}, V_{GS} = 0\text{ V}, f = 100\text{ kHz}$		78		pF	
Output Capacitance	$C_{OSS}$			27			
Reverse Transfer Capacitance	$C_{RSS}$			0.3			
Output Capacitance, Energy Related	$C_{OSS(ER)}$	$V_{DS} = 0\text{ V to } 400\text{ V}, V_{GS} = 0\text{ V}$		38.6		pF	
Output Capacitance, Time Related	$C_{OSS(TR)}$			51.1			
Output Charge	$Q_{OSS}$			20.4			nC
Output Capacitance Stored Energy	$E_{OSS}$			3.1			$\mu\text{J}$
Gate Resistance	$R_G$	$f = 5\text{ MHz}$		11		$\Omega$	
Gate Charge	$Q_G$	$V_{DS} = 400\text{ V}, I_{DS} = 4\text{ A}, V_{GS} = 0/6\text{ V}$		2.1		nC	
Gate-to-Source Charge	$Q_{GS}$			0.2			
Gate-to-Drain Charge	$Q_{GD}$			0.8			
Gate Plateau Voltage	$V_{PLAT}$			2.1			V

### REVERSE CONDUCTION CHARACTERISTICS

Source-to-Drain Reverse Voltage	$V_{SD}$	$V_{GS} = 0\text{ V}, I_{SD} = 4\text{ A}$		2.4		V
Pulsed Reverse Current	$I_{SD(PULSE)}$	$V_{GS} = 6\text{ V}, t_{PULSE} = 10\text{ }\mu\text{s}$			24	A

Product parametric performance is indicated in the Electrical Characteristics for the listed test conditions, unless otherwise noted. Product performance may not be indicated by the Electrical Characteristics if operated under different conditions.

# NTD170N70GN1

## TYPICAL CHARACTERISTICS ( $T_J = 25\text{ }^\circ\text{C}$ UNLESS OTHERWISE SPECIFIED)

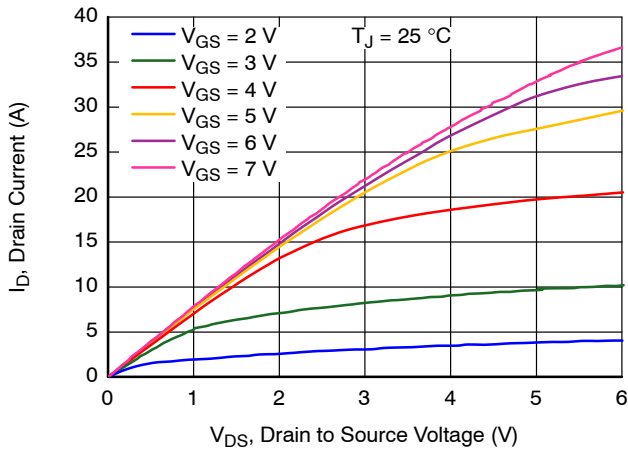

Figure 1. Output Characteristics at  $T_J = 25\text{ }^\circ\text{C}$

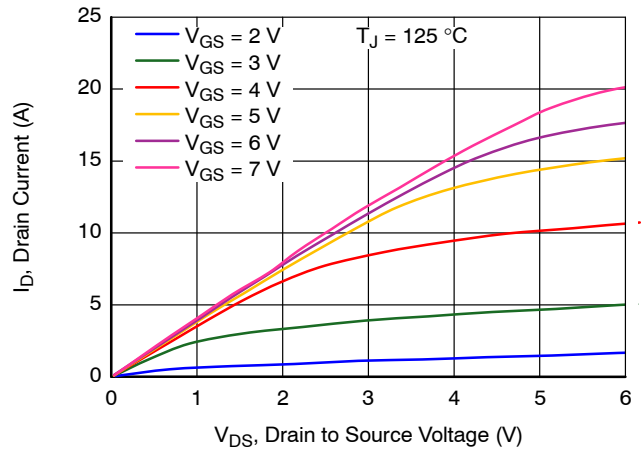

Figure 2. Output Characteristics at  $T_J = 125\text{ }^\circ\text{C}$

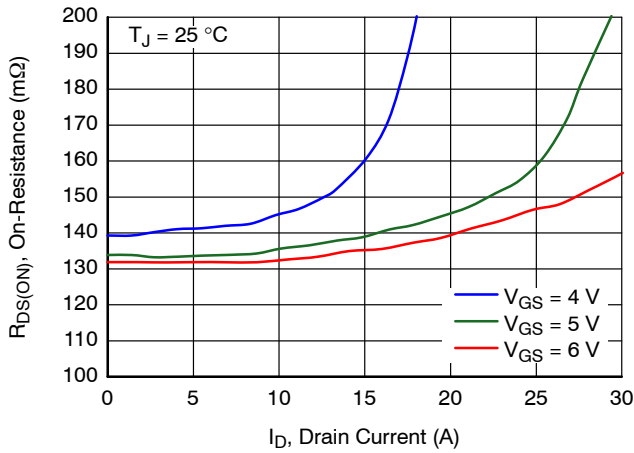

Figure 3. On-Resistance vs. Drain Current at  $T_J = 25\text{ }^\circ\text{C}$

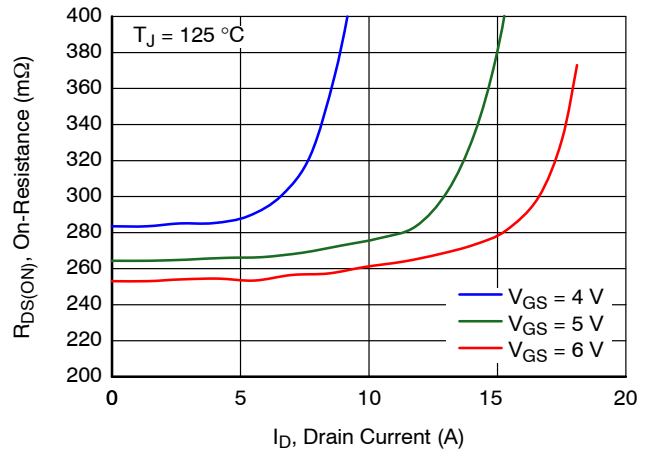

Figure 4. On-Resistance vs. Drain Current at  $T_J = 125\text{ }^\circ\text{C}$

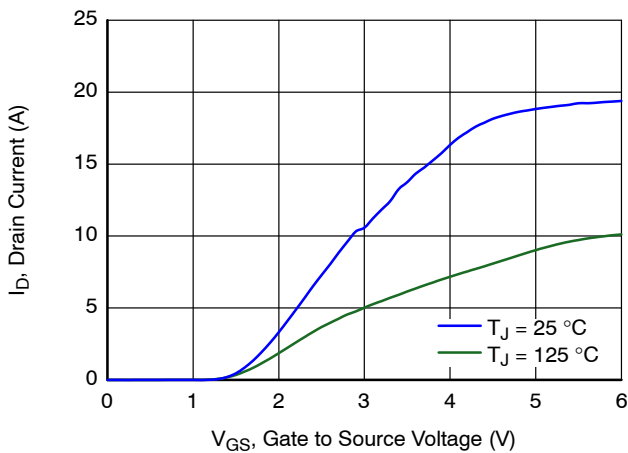

Figure 5. Transfer Characteristics at  $V_{DS} = 3\text{ V}$

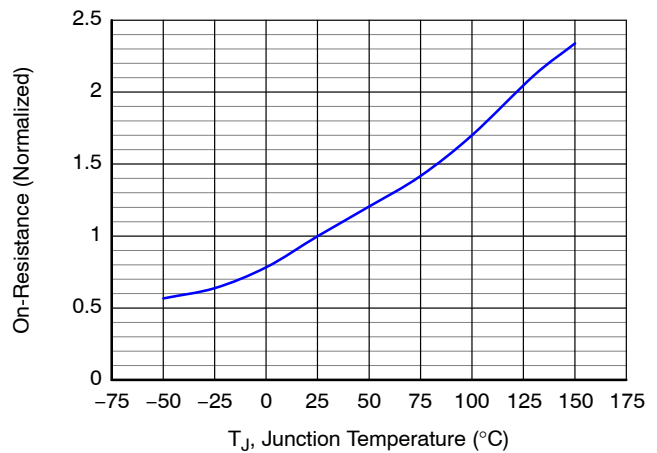

Figure 6. Normalized On-Resistance vs. Temperature at  $V_{GS} = 6\text{ V}$

# NTD170N70GN1

## TYPICAL CHARACTERISTICS ( $T_J = 25\text{ }^\circ\text{C}$ UNLESS OTHERWISE SPECIFIED) (CONTINUED)

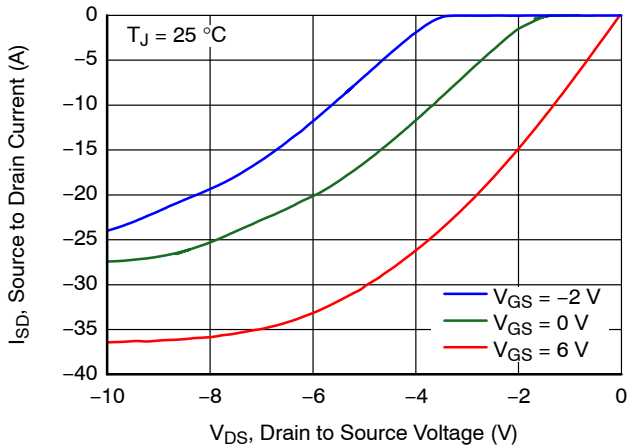

Figure 7. Reverse Conduction Characteristics at  $T_J = 25\text{ }^\circ\text{C}$

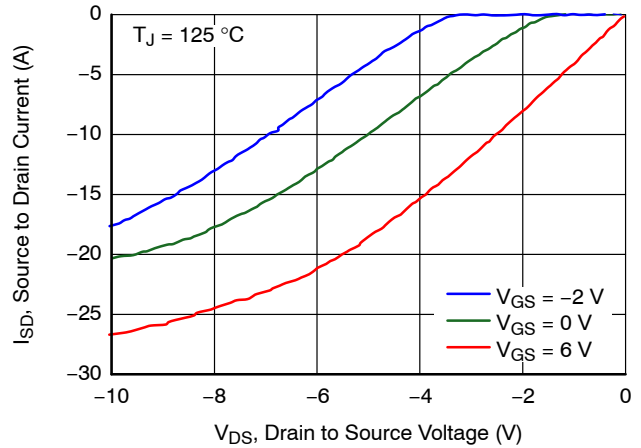

Figure 8. Reverse Conduction Characteristics at  $T_J = 125\text{ }^\circ\text{C}$

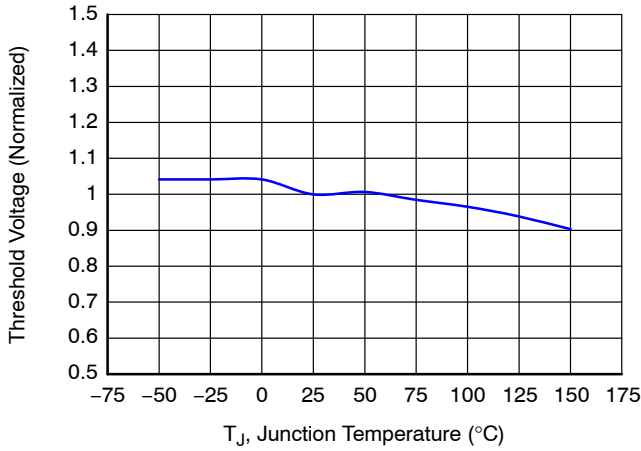

Figure 9. Normalized Threshold Voltage vs. Temperature

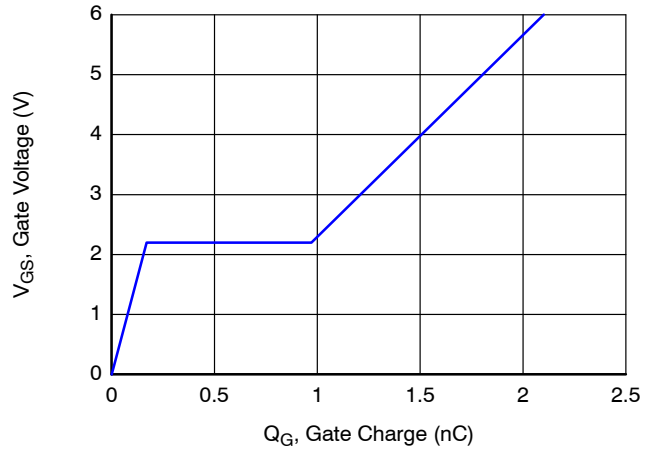

Figure 10. Gate Charge Characteristics at  $I_{DS} = 20\text{ A}$

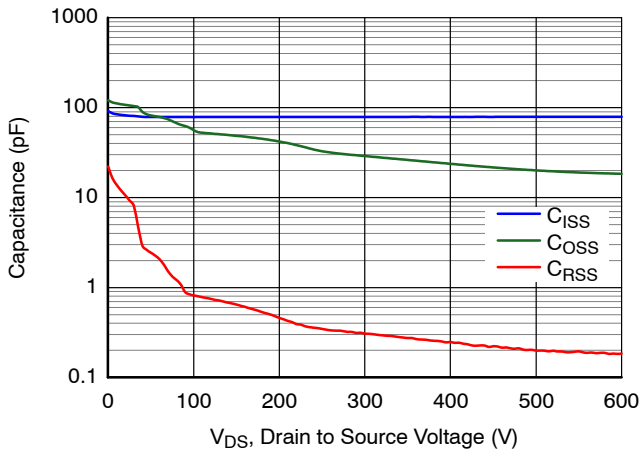

Figure 11. Capacitance Characteristics

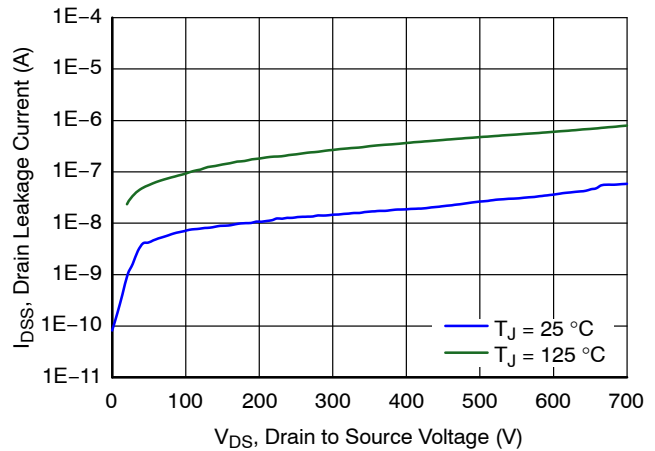

Figure 12. Drain Leakage Characteristics

# NTD170N70GN1

## TYPICAL CHARACTERISTICS ( $T_J = 25\text{ }^\circ\text{C}$ UNLESS OTHERWISE SPECIFIED) (CONTINUED)

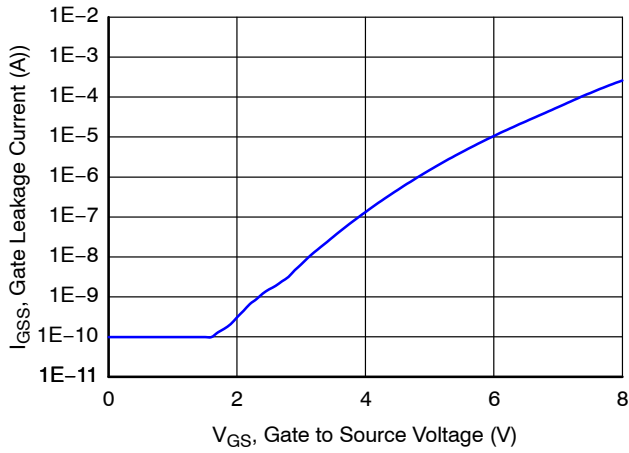

Figure 13. Gate Leakage Characteristics

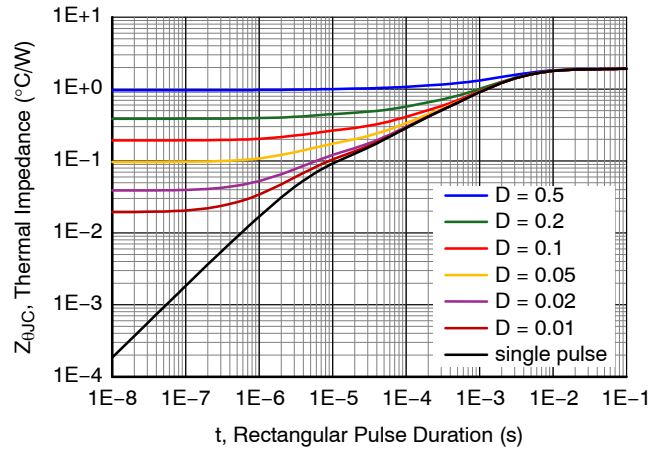

Figure 14. Transient Thermal Impedance

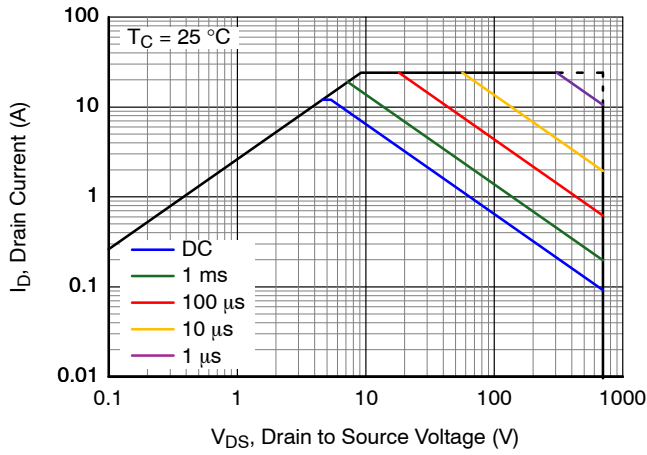

Figure 15. Safe Operating Area at  $T_C = 25\text{ }^\circ\text{C}$

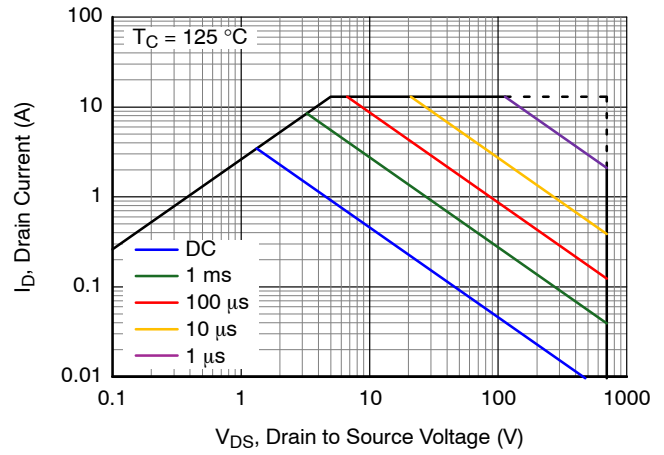
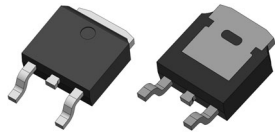

Figure 16. Safe Operating Area at  $T_C = 125\text{ }^\circ\text{C}$

# NTD170N70GN1

## REVISION HISTORY

Revision	Description of Changes	Date
0	Initial production document release.	6/17/2026



**PDSO-E3 6.10x6.60x2.30, 2.28P**  
**CASE 209AA**  
**ISSUE O**

DATE 04 MAY 2026

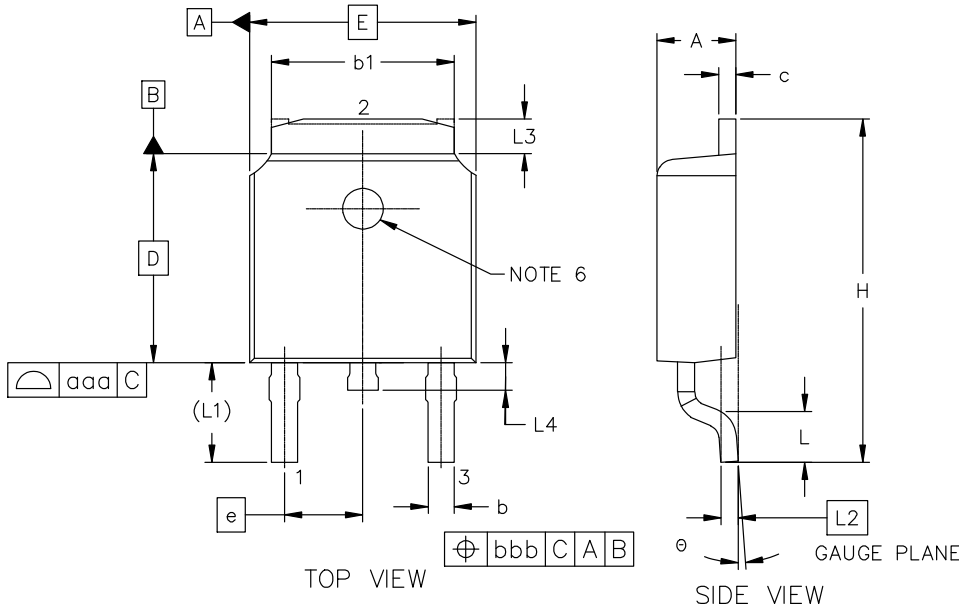

MILLIMETERS			
DIM	MIN	NOM	MAX
A	2.20	2.30	2.40
A1	0.00	0.07	0.13
b	0.63	0.76	0.90
b1	5.10	5.33	5.46
c	0.43	0.53	0.61
D	6.10 BSC		
D1	5.30 REF		
E	6.60 BSC		
E1	4.83 REF		
e	2.286 BSC		
H	9.40	9.95	10.50
L	1.38	1.50	1.75
L1	2.90 REF		
L2	0.50 BSC		
L3	0.88	1.08	1.28
L4	0.50	0.75	1.00
ø	0°	5°	10°
TOLERANCE FORM & POSITION			
aaa	0.15		
bbb	0.20		
eee	0.10		

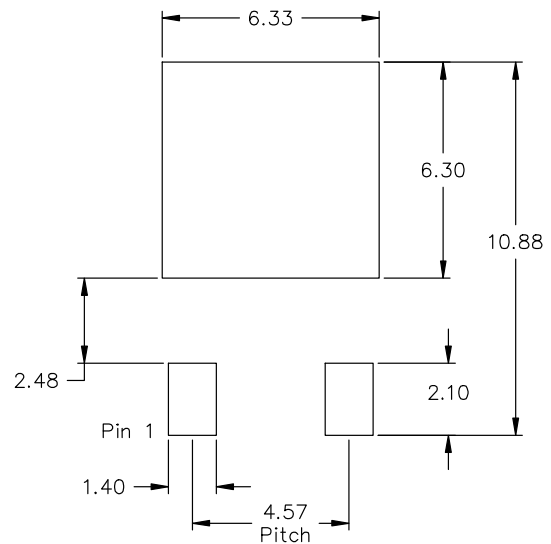
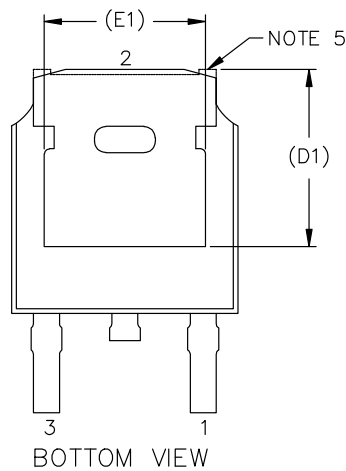
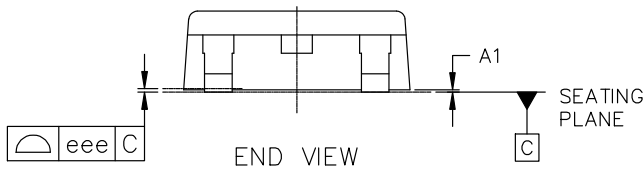

**NOTES:**

1. DIMENSIONING AND TOLERANCING AS PER ASME Y14.5M, 2018.
2. CONTROLLING DIMENSION: MILLIMETERS.
3. DIMENSIONS DO NOT INCLUDE MOLD PROTRUSION.
4. PACKAGE OUTLINE EXCLUSIVE OF METAL BURR DIMENSIONS.
5. SUPPLIER DEPENDENT MOLD LOCKING HOLES OR CHAMFERED CORNERS OR EDGE PROTRUSION.
6. MOLD EJECTION PIN MARK IS OPTIONAL.

**RECOMMENDED MOUNTING FOOTPRINT**

\*For additional information on our Pb-Free strategy and soldering details, please download the onsemi Soldering and Mounting Techniques Reference Manual, SOLDERM/D.

<b>DOCUMENT NUMBER:</b>	<b>98AON76042H</b>	Electronic versions are uncontrolled except when accessed directly from the Document Repository. Printed versions are uncontrolled except when stamped "CONTROLLED COPY" in red.
<b>DESCRIPTION:</b>	<b>PDSO-E3 6.10x6.60x2.30, 2.28P</b>	<b>PAGE 1 OF 2</b>

onsemi and ONSEMI are trademarks of Semiconductor Components Industries, LLC dba onsemi or its subsidiaries in the United States and/or other countries. onsemi reserves the right to make changes without further notice to any products herein. onsemi makes no warranty, representation or guarantee regarding the suitability of its products for any particular purpose, nor does onsemi assume any liability arising out of the application or use of any product or circuit, and specifically disclaims any and all liability, including without limitation special, consequential or incidental damages. onsemi does not convey any license under its patent rights nor the rights of others.

**PDSO-E3 6.10x6.60x2.30, 2.28P**  
CASE 209AA  
ISSUE O

DATE 04 MAY 2026

**GENERIC  
MARKING DIAGRAM\***



XXXX = Specific Device Code  
A = Assembly Location  
YY = Year  
WW = Work Week  
ZZ = Assembly Lot Code

\*This information is generic. Please refer to device data sheet for actual part marking. Pb-Free indicator, "G" or microdot "▪", may or may not be present. Some products may not follow the Generic Marking.

<b>DOCUMENT NUMBER:</b>	<b>98AON76042H</b>	Electronic versions are uncontrolled except when accessed directly from the Document Repository. Printed versions are uncontrolled except when stamped "CONTROLLED COPY" in red.
<b>DESCRIPTION:</b>	<b>PDSO-E3 6.10x6.60x2.30, 2.28P</b>	<b>PAGE 2 OF 2</b>

**onsemi** and **ONSEMI** are trademarks of Semiconductor Components Industries, LLC dba **onsemi** or its subsidiaries in the United States and/or other countries. **onsemi** reserves the right to make changes without further notice to any products herein. **onsemi** makes no warranty, representation or guarantee regarding the suitability of its products for any particular purpose, nor does **onsemi** assume any liability arising out of the application or use of any product or circuit, and specifically disclaims any and all liability, including without limitation special, consequential or incidental damages. **onsemi** does not convey any license under its patent rights nor the rights of others.

**onsemi**, **Onsemi**, and other names, marks, and brands are registered and/or common law trademarks of Semiconductor Components Industries, LLC dba "**onsemi**" or its affiliates and/or subsidiaries in the United States and/or other countries. **onsemi** owns the rights to a number of patents, trademarks, copyrights, trade secrets, and other intellectual property. A listing of **onsemi**'s product/patent coverage may be accessed at [www.onsemi.com/site/pdf/Patent-Marking.pdf](http://www.onsemi.com/site/pdf/Patent-Marking.pdf). **onsemi** reserves the right to make changes at any time to any products or information herein, without notice. The information herein is provided "as-is" and **onsemi** makes no warranty, representation or guarantee regarding the accuracy of the information, product features, availability, functionality, or suitability of its products for any particular purpose, nor does **onsemi** assume any liability arising out of the application or use of any product or circuit, and specifically disclaims any and all liability, including without limitation special, consequential or incidental damages. Buyer is responsible for its products and applications using **onsemi** products, including compliance with all laws, regulations and safety requirements or standards, regardless of any support or applications information provided by **onsemi**. "Typical" parameters which may be provided in **onsemi** data sheets and/or specifications can and do vary in different applications and actual performance may vary over time. All operating parameters, including "Typicals" must be validated for each customer application by customer's technical experts. **onsemi** does not convey any license under any of its intellectual property rights nor the rights of others. **onsemi** products are not designed, intended, or authorized for use as a critical component in life support systems or any FDA Class 3 medical devices or medical devices with a same or similar classification in a foreign jurisdiction or any devices intended for implantation in the human body. Should Buyer purchase or use **onsemi** products for any such unintended or unauthorized application, Buyer shall indemnify and hold **onsemi** and its officers, employees, subsidiaries, affiliates, and distributors harmless against all claims, costs, damages, and expenses, and reasonable attorney fees arising out of, directly or indirectly, any claim of personal injury or death associated with such unintended or unauthorized use, even if such claim alleges that **onsemi** was negligent regarding the design or manufacture of the part. **onsemi** is an Equal Opportunity/Affirmative Action Employer. This literature is subject to all applicable copyright laws and is not for resale in any manner.

## ADDITIONAL INFORMATION

### TECHNICAL PUBLICATIONS:

Technical Library: [www.onsemi.com/design/resources/technical-documentation](http://www.onsemi.com/design/resources/technical-documentation)  
onsemi Website: [www.onsemi.com](http://www.onsemi.com)

### ONLINE SUPPORT: [www.onsemi.com/support](http://www.onsemi.com/support)

For additional information, please contact your local Sales Representative at [www.onsemi.com/support/sales](http://www.onsemi.com/support/sales)