

NTD4858N

MOSFET – Power, Single, N-Channel, DPAK/IPAK 25 V, 73 A



ON Semiconductor®

<http://onsemi.com>

Features

- Trench Technology
- Low $R_{DS(on)}$ to Minimize Conduction Losses
- Low Capacitance to Minimize Driver Losses
- Optimized Gate Charge to Minimize Switching Losses
- These are Pb-Free Devices

Applications

- VCore Applications
- DC-DC Converters
- High/Low Side Switching

MAXIMUM RATINGS ($T_J = 25^\circ\text{C}$ unless otherwise stated)

Parameter	Symbol	Value	Unit		
Drain-to-Source Voltage	V_{DSS}	25	V		
Gate-to-Source Voltage	V_{GS}	± 20	V		
Continuous Drain Current $R_{\theta JA}$ (Note 1)	I_D	$T_A = 25^\circ\text{C}$	14		
		$T_A = 85^\circ\text{C}$	10.9		
Power Dissipation $R_{\theta JA}$ (Note 1)	P_D	$T_A = 25^\circ\text{C}$	2.0		
		$T_A = 85^\circ\text{C}$	8.7		
Continuous Drain Current $R_{\theta JC}$ (Note 2)	I_D	$T_A = 25^\circ\text{C}$	11.2		
		$T_A = 85^\circ\text{C}$	8.7		
Power Dissipation $R_{\theta JC}$ (Note 2)	P_D	$T_A = 25^\circ\text{C}$	1.3		
		$T_C = 25^\circ\text{C}$	56		
Continuous Drain Current $R_{\theta JC}$ (Note 1)	I_D	$T_C = 25^\circ\text{C}$	73		
		$T_C = 85^\circ\text{C}$	56		
Power Dissipation $R_{\theta JC}$ (Note 1)	P_D	$T_C = 25^\circ\text{C}$	54.5		
		$T_C = 85^\circ\text{C}$	54.5		
Pulsed Drain Current	$t_p = 10\mu\text{s}$	$T_A = 25^\circ\text{C}$	I_{DM}	146	A
Current Limited by Package	$T_A = 25^\circ\text{C}$	$I_{DmaxPkg}$	45	A	
Operating Junction and Storage Temperature	T_J, T_{STG}		-55 to +175	$^\circ\text{C}$	
Source Current (Body Diode)	I_S	45	A		
Drain to Source dV/dt	dV/dt	6	V/ns		
Single Pulse Drain-to-Source Avalanche Energy ($T_J = 25^\circ\text{C}$, $V_{DD} = 50\text{ V}$, $V_{GS} = 10\text{ V}$, $I_L = 15\text{ A}_{pk}$, $L = 1.0\text{ mH}$, $R_G = 25\ \Omega$)	EAS	112.5	mJ		
Lead Temperature for Soldering Purposes (1/8" from case for 10 s)	T_L	260	$^\circ\text{C}$		

Stresses exceeding those listed in the Maximum Ratings table may damage the device. If any of these limits are exceeded, device functionality should not be assumed, damage may occur and reliability may be affected.

$V_{(BR)DSS}$	$R_{DS(ON)} \text{ MAX}$	$I_D \text{ MAX}$
25 V	6.2 m Ω @ 10 V	73 A
	9.3 m Ω @ 4.5 V	

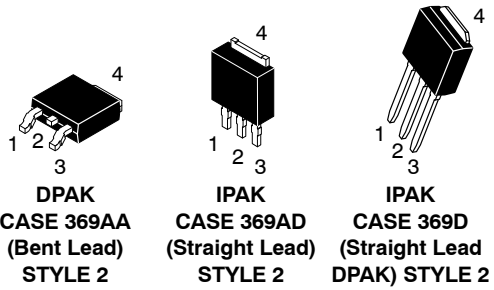
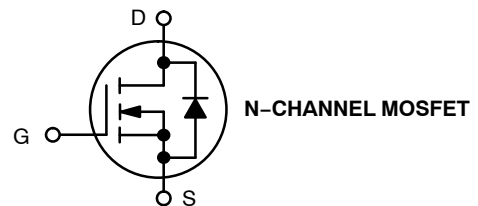

MARKING DIAGRAMS & PIN ASSIGNMENTS

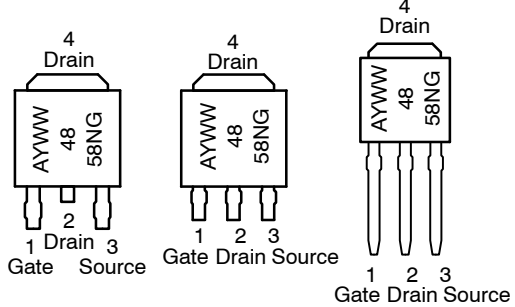

- A = Assembly Location*
- Y = Year
- WW = Work Week
- 4858N = Device Code
- G = Pb-Free Package

* The Assembly Location code (A) is front side optional. In cases where the Assembly Location is stamped in the package, the front side assembly code may be blank.

ORDERING INFORMATION

See detailed ordering and shipping information in the package dimensions section on page 6 of this data sheet.

NTD4858N

THERMAL RESISTANCE MAXIMUM RATINGS

Parameter	Symbol	Value	Unit
Junction-to-Case (Drain)	$R_{\theta JC}$	2.75	°C/W
Junction-to-TAB (Drain)	$R_{\theta JC-TAB}$	3.5	
Junction-to-Ambient – Steady State (Note 1)	$R_{\theta JA}$	73.5	
Junction-to-Ambient – Steady State (Note 2)	$R_{\theta JA}$	116	

- Surface-mounted on FR4 board using 1 sq-in pad, 1 oz Cu.
- Surface-mounted on FR4 board using the minimum recommended pad size.

ELECTRICAL CHARACTERISTICS ($T_J = 25^\circ\text{C}$ unless otherwise specified)

Parameter	Symbol	Test Condition	Min	Typ	Max	Unit
-----------	--------	----------------	-----	-----	-----	------

OFF CHARACTERISTICS

Drain-to-Source Breakdown Voltage	$V_{(BR)DSS}$	$V_{GS} = 0\text{ V}, I_D = 250\ \mu\text{A}$	25			V
Drain-to-Source Breakdown Voltage Temperature Coefficient	$V_{(BR)DSS}/T_J$			22		mV/°C
Zero Gate Voltage Drain Current	I_{DSS}	$V_{GS} = 0\text{ V}, V_{DS} = 20\text{ V}$	$T_J = 25^\circ\text{C}$		1.0	μA
			$T_J = 125^\circ\text{C}$		10	
Gate-to-Source Leakage Current	I_{GSS}	$V_{DS} = 0\text{ V}, V_{GS} = \pm 20\text{ V}$			± 100	nA

ON CHARACTERISTICS (Note 3)

Gate Threshold Voltage	$V_{GS(TH)}$	$V_{GS} = V_{DS}, I_D = 250\ \mu\text{A}$	1.45		2.5	V	
Negative Threshold Temperature Coefficient	$V_{GS(TH)}/T_J$			5.3		mV/°C	
Drain-to-Source On Resistance	$R_{DS(on)}$	$V_{GS} = 10\text{ V}$	$I_D = 30\text{ A}$		5.2	6.2	m Ω
		$V_{GS} = 4.5\text{ V}$	$I_D = 30\text{ A}$		7.3	9.3	
Forward Transconductance	g_{FS}	$V_{DS} = 1.5\text{ V}, I_D = 15\text{ A}$		55		S	

CHARGES AND CAPACITANCES

Input Capacitance	C_{ISS}	$V_{GS} = 0\text{ V}, f = 1.0\text{ MHz}, V_{DS} = 12\text{ V}$		1563		pF
Output Capacitance	C_{OSS}			405		
Reverse Transfer Capacitance	C_{RSS}			200		
Total Gate Charge	$Q_{G(TOT)}$	$V_{GS} = 4.5\text{ V}, V_{DS} = 15\text{ V}, I_D = 30\text{ A}$		12.8	19.2	nC
Threshold Gate Charge	$Q_{G(TH)}$			1.3		
Gate-to-Source Charge	Q_{GS}			4.7		
Gate-to-Drain Charge	Q_{GD}			5.2		
Total Gate Charge	$Q_{G(TOT)}$	$V_{GS} = 10\text{ V}, V_{DS} = 15\text{ V}, I_D = 30\text{ A}$		25.7		nC

SWITCHING CHARACTERISTICS (Note 4)

Turn-On Delay Time	$t_{d(ON)}$	$V_{GS} = 4.5\text{ V}, V_{DS} = 15\text{ V}, I_D = 15\text{ A}, R_G = 3.0\ \Omega$		12.6		ns
Rise Time	t_r			20.2		
Turn-Off Delay Time	$t_{d(OFF)}$			16.4		
Fall Time	t_f			5.1		

Product parametric performance is indicated in the Electrical Characteristics for the listed test conditions, unless otherwise noted. Product performance may not be indicated by the Electrical Characteristics if operated under different conditions.

- Pulse Test: pulse width $\leq 300\ \mu\text{s}$, duty cycle $\leq 2\%$.
- Switching characteristics are independent of operating junction temperatures.

NTD4858N

ELECTRICAL CHARACTERISTICS ($T_J = 25^\circ\text{C}$ unless otherwise specified) (continued)

Parameter	Symbol	Test Condition	Min	Typ	Max	Unit
SWITCHING CHARACTERISTICS (Note 4)						
Turn-On Delay Time	$t_{d(ON)}$	$V_{GS} = 11.5\text{ V}, V_{DS} = 15\text{ V},$ $I_D = 15\text{ A}, R_G = 3.0\ \Omega$		7.7		ns
Rise Time	t_r			17.3		
Turn-Off Delay Time	$t_{d(OFF)}$			23.8		
Fall Time	t_f			2.8		

DRAIN-SOURCE DIODE CHARACTERISTICS

Forward Diode Voltage	V_{SD}	$V_{GS} = 0\text{ V},$ $I_S = 30\text{ A}$	$T_J = 25^\circ\text{C}$		0.87	1.2	V
			$T_J = 125^\circ\text{C}$		0.73		
Reverse Recovery Time	t_{RR}	$V_{GS} = 0\text{ V}, dI_S/dt = 100\text{ A}/\mu\text{s},$ $I_S = 30\text{ A}$		11.6		ns	
Charge Time	t_a			7.8			
Discharge Time	t_b			3.7			
Reverse Recovery Charge	Q_{RR}			3.0		nC	

PACKAGE PARASITIC VALUES

Source Inductance	L_S	$T_A = 25^\circ\text{C}$		2.49		nH
Drain Inductance, DPAK	L_D			0.0164		
Drain Inductance, IPAK	L_D			1.88		
Gate Inductance	L_G			3.46		
Gate Resistance	R_G			0.7		

Product parametric performance is indicated in the Electrical Characteristics for the listed test conditions, unless otherwise noted. Product performance may not be indicated by the Electrical Characteristics if operated under different conditions.

3. Pulse Test: pulse width $\leq 300\ \mu\text{s}$, duty cycle $\leq 2\%$.

4. Switching characteristics are independent of operating junction temperatures.

TYPICAL PERFORMANCE CURVES

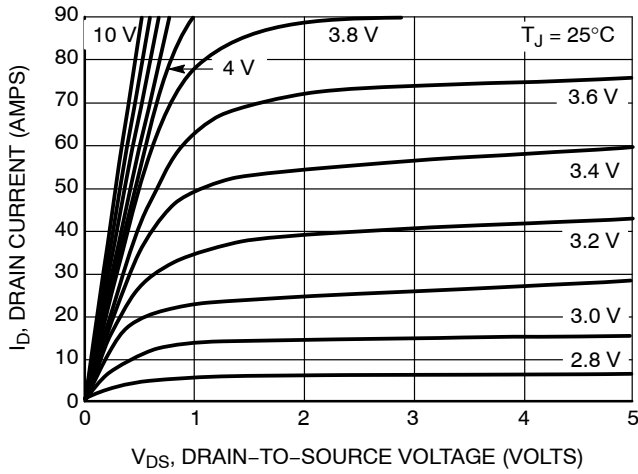

Figure 1. On-Region Characteristics

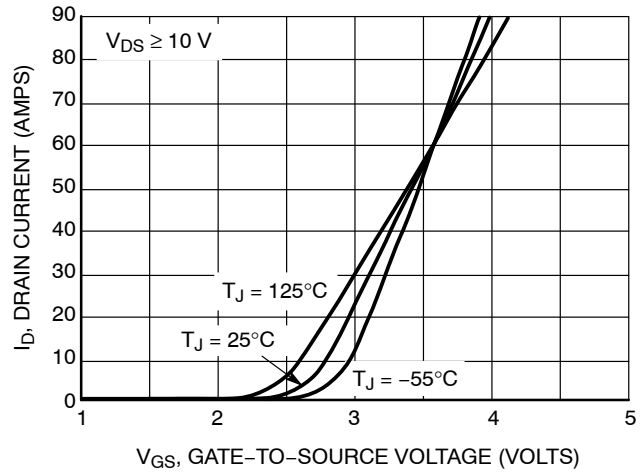

Figure 2. Transfer Characteristics

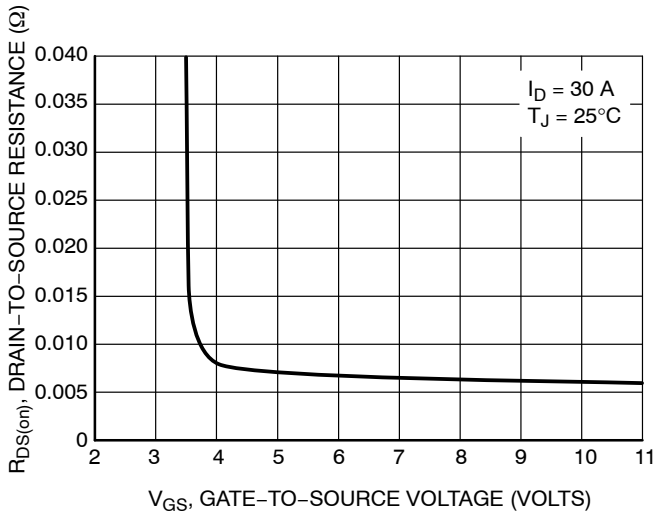

Figure 3. On-Resistance vs. Gate-to-Source Voltage

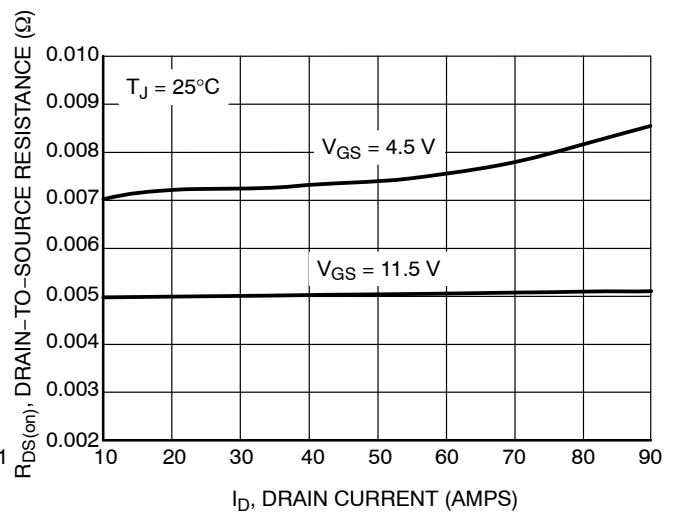

Figure 4. On-Resistance vs. Drain Current and Gate Voltage

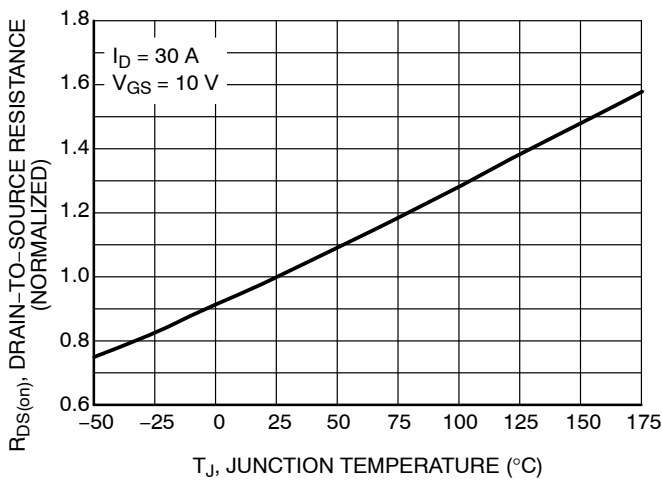

Figure 5. On-Resistance Variation with Temperature

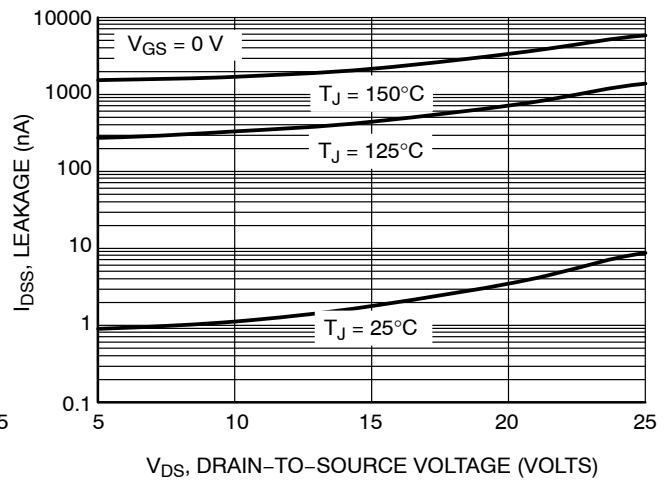

Figure 6. Drain-to-Source Leakage Current vs. Drain Voltage

TYPICAL PERFORMANCE CURVES

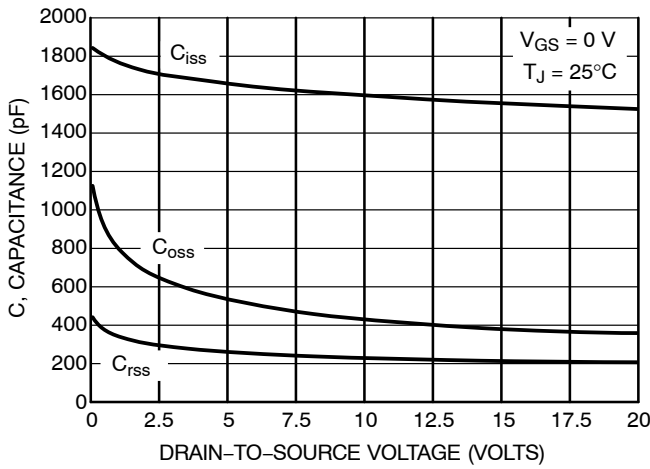

Figure 7. Capacitance Variation

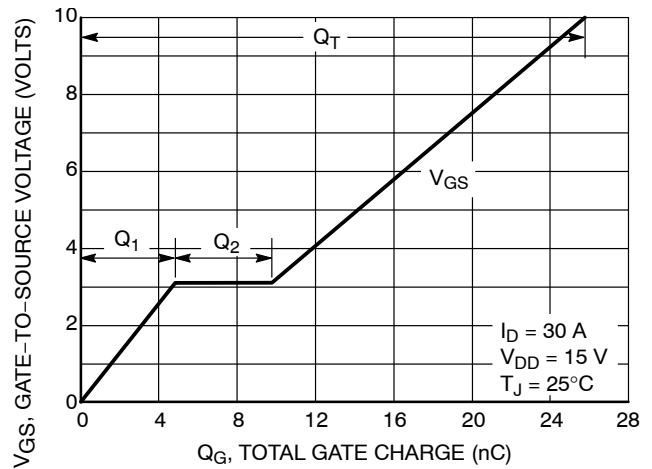

Figure 8. Gate-To-Source and Drain-To-Source Voltage vs. Total Charge

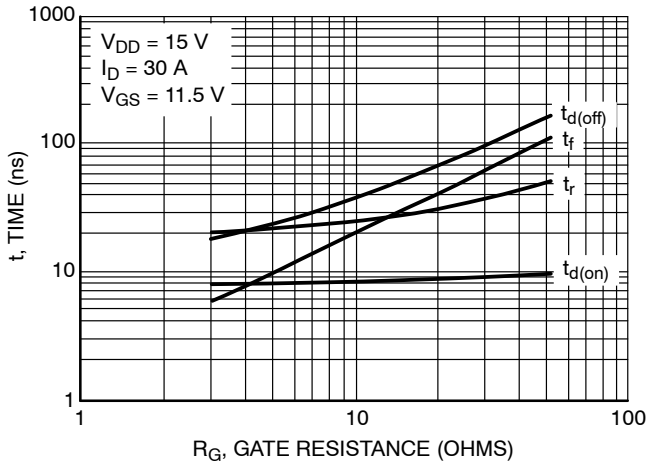

Figure 9. Resistive Switching Time Variation vs. Gate Resistance

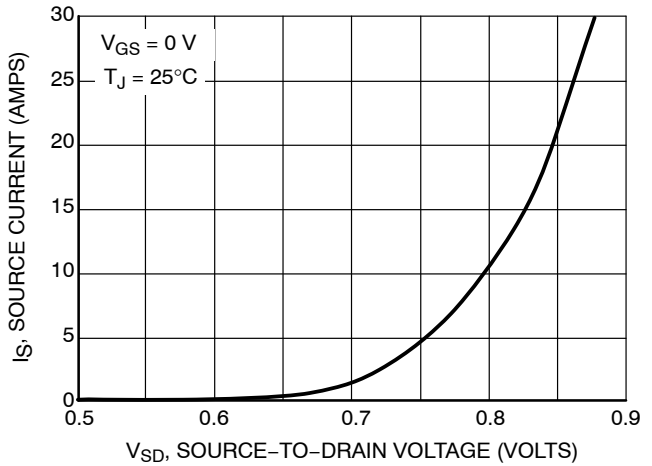

Figure 10. Diode Forward Voltage vs. Current

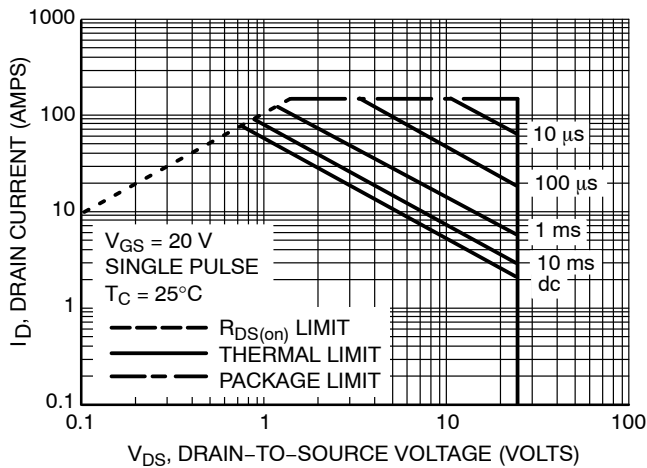

Figure 11. Maximum Rated Forward Biased Safe Operating Area

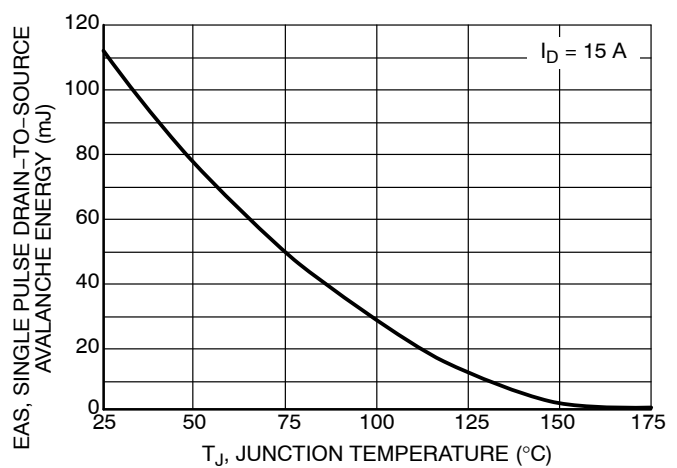

Figure 12. Maximum Avalanche Energy vs. Starting Junction Temperature

NTD4858N

TYPICAL PERFORMANCE CURVES

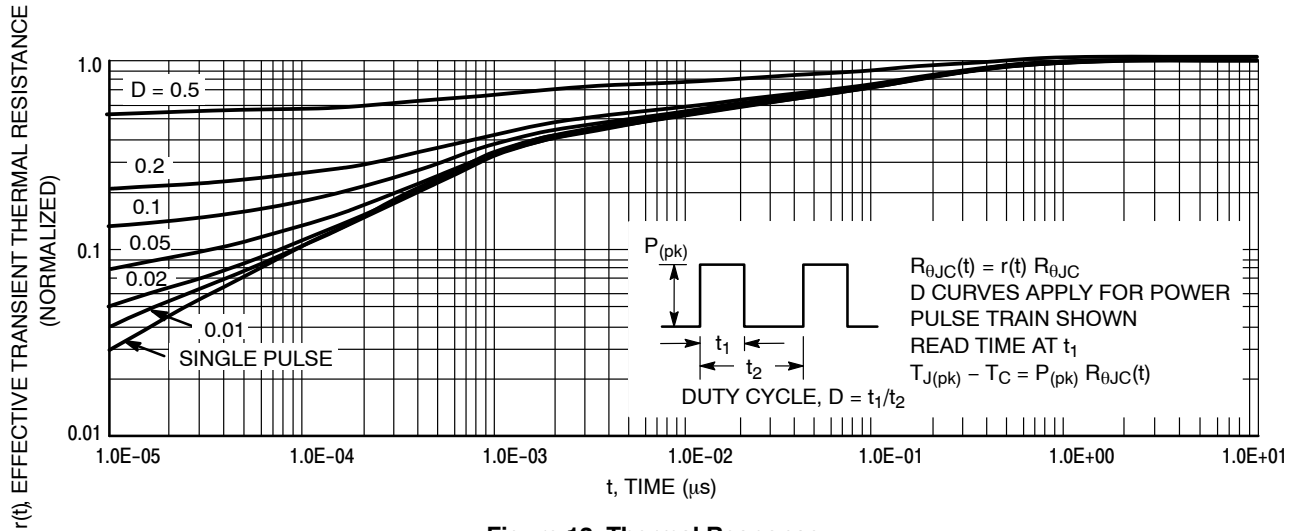

Figure 13. Thermal Response

ORDERING INFORMATION

Device	Package	Shipping†
NTD4858NT4G	DPAK (Pb-Free)	2500 / Tape & Reel
NTD4858N-1G	IPAK (Pb-Free)	75 Units / Rail
NTD4858N-35G	IPAK Trimmed Lead (3.5 ± 0.15 mm) (Pb-Free)	75 Units / Rail

†For information on tape and reel specifications, including part orientation and tape sizes, please refer to our Tape and Reel Packaging Specifications Brochure, BRD8011/D.

MECHANICAL CASE OUTLINE

PACKAGE DIMENSIONS

ON Semiconductor®



IPAK CASE 369D-01 ISSUE C

DATE 15 DEC 2010

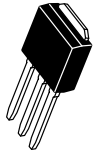

SCALE 1:1



- NOTES:
1. DIMENSIONING AND TOLERANCING PER ANSI Y14.5M, 1982.
 2. CONTROLLING DIMENSION: INCH.

DIM	INCHES		MILLIMETERS	
	MIN	MAX	MIN	MAX
A	0.235	0.245	5.97	6.35
B	0.250	0.265	6.35	6.73
C	0.086	0.094	2.19	2.38
D	0.027	0.035	0.69	0.88
E	0.018	0.023	0.46	0.58
F	0.037	0.045	0.94	1.14
G	0.090	BSC	2.29	BSC
H	0.034	0.040	0.87	1.01
J	0.018	0.023	0.46	0.58
K	0.350	0.380	8.89	9.65
R	0.180	0.215	4.45	5.45
S	0.025	0.040	0.63	1.01
V	0.035	0.050	0.89	1.27
Z	0.155	---	3.93	---

- | | | | |
|--|---|--|--|
| <p>STYLE 1:
PIN 1. BASE
2. COLLECTOR
3. EMITTER
4. COLLECTOR</p> | <p>STYLE 2:
PIN 1. GATE
2. DRAIN
3. SOURCE
4. DRAIN</p> | <p>STYLE 3:
PIN 1. ANODE
2. CATHODE
3. ANODE
4. CATHODE</p> | <p>STYLE 4:
PIN 1. CATHODE
2. ANODE
3. GATE
4. ANODE</p> |
| <p>STYLE 5:
PIN 1. GATE
2. ANODE
3. CATHODE
4. ANODE</p> | <p>STYLE 6:
PIN 1. MT1
2. MT2
3. GATE
4. MT2</p> | <p>STYLE 7:
PIN 1. GATE
2. COLLECTOR
3. EMITTER
4. COLLECTOR</p> | |

MARKING DIAGRAMS



- xxxxxxxx = Device Code
 A = Assembly Location
 IL = Wafer Lot
 Y = Year
 WW = Work Week

DOCUMENT NUMBER:	98AON10528D	Electronic versions are uncontrolled except when accessed directly from the Document Repository. Printed versions are uncontrolled except when stamped "CONTROLLED COPY" in red.
DESCRIPTION:	IPAK (DPAK INSERTION MOUNT)	PAGE 1 OF 1

ON Semiconductor and are trademarks of Semiconductor Components Industries, LLC dba ON Semiconductor or its subsidiaries in the United States and/or other countries. ON Semiconductor reserves the right to make changes without further notice to any products herein. ON Semiconductor makes no warranty, representation or guarantee regarding the suitability of its products for any particular purpose, nor does ON Semiconductor assume any liability arising out of the application or use of any product or circuit, and specifically disclaims any and all liability, including without limitation special, consequential or incidental damages. ON Semiconductor does not convey any license under its patent rights nor the rights of others.

MECHANICAL CASE OUTLINE

PACKAGE DIMENSIONS

ON Semiconductor®



SCALE 1:1

DPAK (SINGLE GAUGE)

CASE 369AA-01

ISSUE B

DATE 03 JUN 2010



NOTES:

- DIMENSIONING AND TOLERANCING PER ASME Y14.5M, 1994.
- CONTROLLING DIMENSION: INCHES.
- THERMAL PAD CONTOUR OPTIONAL WITHIN DIMENSIONS b3, L3 and Z.
- DIMENSIONS D AND E DO NOT INCLUDE MOLD FLASH, PROTRUSIONS, OR BURRS. MOLD FLASH, PROTRUSIONS, OR GATE BURRS SHALL NOT EXCEED 0.006 INCHES PER SIDE.
- DIMENSIONS D AND E ARE DETERMINED AT THE OUTERMOST EXTREMES OF THE PLASTIC BODY.
- DATUMS A AND B ARE DETERMINED AT DATUM PLANE H.

DIM	INCHES		MILLIMETERS	
	MIN	MAX	MIN	MAX
A	0.086	0.094	2.18	2.38
A1	0.000	0.005	0.00	0.13
b	0.025	0.035	0.63	0.89
b2	0.030	0.045	0.76	1.14
b3	0.180	0.215	4.57	5.46
c	0.018	0.024	0.46	0.61
c2	0.018	0.024	0.46	0.61
D	0.235	0.245	5.97	6.22
E	0.250	0.265	6.35	6.73
e	0.090 BSC		2.29 BSC	
H	0.370	0.410	9.40	10.41
L	0.055	0.070	1.40	1.78
L1	0.108 REF		2.74 REF	
L2	0.020 BSC		0.51 BSC	
L3	0.035	0.050	0.89	1.27
L4	---	0.040	---	1.01
Z	0.155	---	3.93	---

- | | | | |
|--|---|--|--|
| <p>STYLE 1:
PIN 1. BASE
2. COLLECTOR
3. EMITTER
4. COLLECTOR</p> | <p>STYLE 2:
PIN 1. GATE
2. DRAIN
3. SOURCE
4. DRAIN</p> | <p>STYLE 3:
PIN 1. ANODE
2. CATHODE
3. ANODE
4. CATHODE</p> | <p>STYLE 4:
PIN 1. CATHODE
2. ANODE
3. GATE
4. ANODE</p> |
| <p>STYLE 5:
PIN 1. GATE
2. ANODE
3. CATHODE
4. ANODE</p> | <p>STYLE 6:
PIN 1. MT1
2. MT2
3. GATE
4. MT2</p> | <p>STYLE 7:
PIN 1. GATE
2. ANODE
3. EMITTER
4. COLLECTOR</p> | |

GENERIC MARKING DIAGRAM*



IC Discrete

- XXXXXX = Device Code
- A = Assembly Location
- L = Wafer Lot
- Y = Year
- WW = Work Week
- G = Pb-Free Package

*This information is generic. Please refer to device data sheet for actual part marking.

SOLDERING FOOTPRINT*



SCALE 3:1 (mm/inches)

*For additional information on our Pb-Free strategy and soldering details, please download the ON Semiconductor Soldering and Mounting Techniques Reference Manual, SOLDERRM/D.

DOCUMENT NUMBER:	98AON13126D	Electronic versions are uncontrolled except when accessed directly from the Document Repository. Printed versions are uncontrolled except when stamped "CONTROLLED COPY" in red.
DESCRIPTION:	DPAK (SINGLE GAUGE)	PAGE 1 OF 1

ON Semiconductor and ON are trademarks of Semiconductor Components Industries, LLC dba ON Semiconductor or its subsidiaries in the United States and/or other countries. ON Semiconductor reserves the right to make changes without further notice to any products herein. ON Semiconductor makes no warranty, representation or guarantee regarding the suitability of its products for any particular purpose, nor does ON Semiconductor assume any liability arising out of the application or use of any product or circuit, and specifically disclaims any and all liability, including without limitation special, consequential or incidental damages. ON Semiconductor does not convey any license under its patent rights nor the rights of others.

MECHANICAL CASE OUTLINE

PACKAGE DIMENSIONS

ON Semiconductor®



3.5 MM IPAK, STRAIGHT LEAD

CASE 369AD

ISSUE B

DATE 18 APR 2013

SCALE 1:1

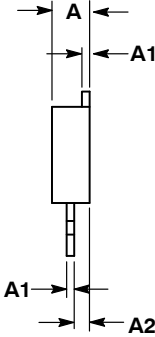
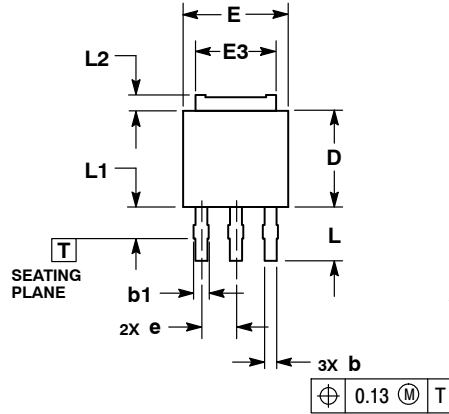

OPTIONAL CONSTRUCTION

NOTES:

- 1.. DIMENSIONING AND TOLERANCING PER ASME Y14.5M, 1994.
- 2.. CONTROLLING DIMENSION: MILLIMETERS.
3. DIMENSION b APPLIES TO PLATED TERMINAL AND IS MEASURED BETWEEN 0.15 AND 0.30mm FROM TERMINAL TIP.
4. DIMENSIONS D AND E DO NOT INCLUDE MOLD GATE OR MOLD FLASH.

DIM	MILLIMETERS	
	MIN	MAX
A	2.19	2.38
A1	0.46	0.60
A2	0.87	1.10
b	0.69	0.89
b1	0.77	1.10
D	5.97	6.22
D2	4.80	---
E	6.35	6.73
E2	4.57	5.45
E3	4.45	5.46
e	2.28 BSC	
L	3.40	3.60
L1	---	2.10
L2	0.89	1.27

GENERIC MARKING DIAGRAMS*

STYLE 1:
PIN 1. BASE
2. COLLECTOR
3. EMITTER
4. COLLECTOR

STYLE 2:
PIN 1. GATE
2. DRAIN
3. SOURCE
4. DRAIN

STYLE 3:
PIN 1. ANODE
2. CATHODE
3. ANODE
4. CATHODE

STYLE 4:
PIN 1. CATHODE
2. ANODE
3. GATE
4. ANODE

STYLE 5:
PIN 1. GATE
2. ANODE
3. CATHODE
4. ANODE

STYLE 6:
PIN 1. MT1
2. MT2
3. GATE
4. MT2

STYLE 7:
PIN 1. GATE
2. COLLECTOR
3. EMITTER
4. COLLECTOR



XXXXXX = Device Code
A = Assembly Location
L = Wafer Lot
Y = Year
WW = Work Week
G = Pb-Free Package

*This information is generic. Please refer to device data sheet for actual part marking. Pb-Free indicator, "G" or microdot "▪", may or may not be present.

DOCUMENT NUMBER:	98AON23319D	Electronic versions are uncontrolled except when accessed directly from the Document Repository. Printed versions are uncontrolled except when stamped "CONTROLLED COPY" in red.
DESCRIPTION:	3.5 MM IPAK, STRAIGHT LEAD	PAGE 1 OF 1

ON Semiconductor and are trademarks of Semiconductor Components Industries, LLC dba ON Semiconductor or its subsidiaries in the United States and/or other countries. ON Semiconductor reserves the right to make changes without further notice to any products herein. ON Semiconductor makes no warranty, representation or guarantee regarding the suitability of its products for any particular purpose, nor does ON Semiconductor assume any liability arising out of the application or use of any product or circuit, and specifically disclaims any and all liability, including without limitation special, consequential or incidental damages. ON Semiconductor does not convey any license under its patent rights nor the rights of others.

onsemi, **Onsemi**, and other names, marks, and brands are registered and/or common law trademarks of Semiconductor Components Industries, LLC dba "**onsemi**" or its affiliates and/or subsidiaries in the United States and/or other countries. **onsemi** owns the rights to a number of patents, trademarks, copyrights, trade secrets, and other intellectual property. A listing of **onsemi**'s product/patent coverage may be accessed at www.onsemi.com/site/pdf/Patent-Marking.pdf. **onsemi** reserves the right to make changes at any time to any products or information herein, without notice. The information herein is provided "as-is" and **onsemi** makes no warranty, representation or guarantee regarding the accuracy of the information, product features, availability, functionality, or suitability of its products for any particular purpose, nor does **onsemi** assume any liability arising out of the application or use of any product or circuit, and specifically disclaims any and all liability, including without limitation special, consequential or incidental damages. Buyer is responsible for its products and applications using **onsemi** products, including compliance with all laws, regulations and safety requirements or standards, regardless of any support or applications information provided by **onsemi**. "Typical" parameters which may be provided in **onsemi** data sheets and/or specifications can and do vary in different applications and actual performance may vary over time. All operating parameters, including "Typicals" must be validated for each customer application by customer's technical experts. **onsemi** does not convey any license under any of its intellectual property rights nor the rights of others. **onsemi** products are not designed, intended, or authorized for use as a critical component in life support systems or any FDA Class 3 medical devices or medical devices with a same or similar classification in a foreign jurisdiction or any devices intended for implantation in the human body. Should Buyer purchase or use **onsemi** products for any such unintended or unauthorized application, Buyer shall indemnify and hold **onsemi** and its officers, employees, subsidiaries, affiliates, and distributors harmless against all claims, costs, damages, and expenses, and reasonable attorney fees arising out of, directly or indirectly, any claim of personal injury or death associated with such unintended or unauthorized use, even if such claim alleges that **onsemi** was negligent regarding the design or manufacture of the part. **onsemi** is an Equal Opportunity/Affirmative Action Employer. This literature is subject to all applicable copyright laws and is not for resale in any manner.

ADDITIONAL INFORMATION

TECHNICAL PUBLICATIONS:

Technical Library: www.onsemi.com/design/resources/technical-documentation
onsemi Website: www.onsemi.com

ONLINE SUPPORT: www.onsemi.com/support

For additional information, please contact your local Sales Representative at www.onsemi.com/support/sales