

Silicon Carbide (SiC) MOSFET - EliteSiC, 960 mohm, 1700 V, M1, TO-247-3L NTHL1000N170M1

Features

- Typ. $R_{DS(on)} = 960\text{ m}\Omega$
- Ultra Low Gate Charge (typ. $Q_{G(tot)} = 14\text{ nC}$)
- Low Effective Output Capacitance (typ. $C_{oss} = 11\text{ pF}$)
- 100% Avalanche Tested
- RoHS Compliant

Typical Applications

- Solar Inverters
- Electric Vehicle Charging Stations
- Electric Storing Systems
- SMPS (Switch Mode Power Supplies)
- UPS (Uninterruptible Power Supplies)

MAXIMUM RATINGS ($T_J = 25^\circ\text{C}$ unless otherwise noted)

Parameter		Symbol	Value	Unit	
Drain-to-Source Voltage		V_{DSS}	1700	V	
Gate-to-Source Voltage		V_{GS}	-15/+25	V	
Recommended Operation Values of Gate-to-Source Voltage		$T_C < 175^\circ\text{C}$ V_{GSop}	-5/+20	V	
Continuous Drain Current (Note 1)	Steady State	$T_C = 25^\circ\text{C}$	I_D	4.2	A
			P_D	48	W
Power Dissipation (Note 1)	Steady State	$T_C = 100^\circ\text{C}$	I_D	3	A
			P_D	24	W
Pulsed Drain Current (Note 2)	$T_C = 25^\circ\text{C}$		I_{DM}	14	A
Operating Junction and Storage Temperature Range		T_J, T_{stg}	-55 to +175	$^\circ\text{C}$	
Source Current (Body Diode)		I_S	9.5	A	
Single Pulse Drain-to-Source Avalanche Energy (Note 3)		E_{AS}	24	mJ	
Maximum Lead Temperature for Soldering (1/25" from case for 10 s)		T_L	270	$^\circ\text{C}$	

Stresses exceeding those listed in the Maximum Ratings table may damage the device. If any of these limits are exceeded, device functionality should not be assumed, damage may occur and reliability may be affected.

1. The entire application environment impacts the thermal resistance values shown, they are not constants and are only valid for the particular conditions noted.
2. Repetitive rating, limited by max junction temperature.
3. E_{AS} of 24 mJ is based on starting $T_J = 25^\circ\text{C}$; $L = 1\text{ mH}$, $I_{AS} = 6.9\text{ A}$, $V_{DD} = 120\text{ V}$, $V_{GS} = 20\text{ V}$.

$V_{(BR)DSS}$	$R_{DS(ON)}$ TYP	I_D MAX
1700 V	960 m Ω @ 20 V	4.2 A

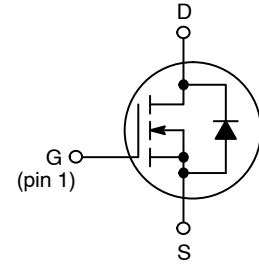

N-CHANNEL MOSFET

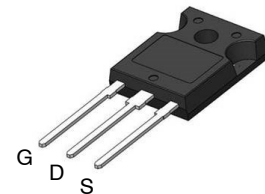

TO-247-3LD
CASE 340CX

MARKING DIAGRAM



A = Assembly Location
Y = Year
WW = Work Week
ZZ = Lot Traceability
HL1000N170M1 = Specific Device Code

ORDERING INFORMATION

Device	Package	Shipping
NTHL1000N170M1	TO-247-3L	30 Units / Tube

NTHL1000N170M1

THEMAL RESISTANCE MAXIMUM RATINGS

Parameter	Symbol	Max	Unit
Junction-to-Case – Steady State (Note 1)	$R_{\theta JC}$	3.1	$^{\circ}\text{C}/\text{W}$

ELECTRICAL CHARACTERISTICS ($T_J = 25^{\circ}\text{C}$ unless otherwise specified)

Parameter	Symbol	Test Condition	Min	Typ	Max	Unit
-----------	--------	----------------	-----	-----	-----	------

OFF CHARACTERISTICS

Drain-to-Source Breakdown Voltage	$V_{(BR)DSS}$	$V_{GS} = 0\text{ V}, I_D = 1\text{ mA}$	1700			V
Drain-to-Source Breakdown Voltage Temperature Coefficient	$V_{(BR)DSS}/T_J$	$I_D = 1\text{ mA}$, referenced to 25°C (Note 4)		0.5		$\text{V}/^{\circ}\text{C}$
Zero Gate Voltage Drain Current	I_{DSS}	$V_{GS} = 0\text{ V}, V_{DS} = 1700\text{ V}$	$T_J = 25^{\circ}\text{C}$		100	μA
			$T_J = 175^{\circ}\text{C}$		1	mA
Gate-to-Source Leakage Current	I_{GSS}	$V_{GS} = +25/-15\text{ V}, V_{DS} = 0\text{ V}$			± 1	μA

ON CHARACTERISTICS (Note 2)

Gate Threshold Voltage	$V_{GS(TH)}$	$V_{GS} = V_{DS}, I_D = 640\text{ }\mu\text{A}$	1.8	3.2	4.3	V
Recommended Gate Voltage	V_{GOP}		-5		+20	V
Drain-to-Source On Resistance	$R_{DS(on)}$	$V_{GS} = 20\text{ V}, I_D = 2\text{ A}, T_J = 25^{\circ}\text{C}$ $V_{GS} = 20\text{ V}, I_D = 2\text{ A}, T_J = 175^{\circ}\text{C}$ (Note 4)		960	1430	$\text{m}\Omega$
				1800		
Forward Transconductance	g_{FS}	$V_{DS} = 10\text{ V}, I_D = 2\text{ A}$ (Note 4)		0.6		S

CHARGES, CAPACITANCES & GATE RESISTANCE (Note 4)

Input Capacitance	C_{ISS}	$V_{GS} = 0\text{ V}, f = 1\text{ MHz}, V_{DS} = 1000\text{ V}$		150		pF
Output Capacitance	C_{OSS}			11		
Reverse Transfer Capacitance	C_{RSS}			0.6		
Total Gate Charge	$Q_{G(TOT)}$	$V_{GS} = -5/20\text{ V}, V_{DS} = 800\text{ V}, I_D = 2\text{ A}$		14		nC
Threshold Gate Charge	$Q_{G(TH)}$			1.5		
Gate-to-Source Charge	Q_{GS}			2.6		
Gate-to-Drain Charge	Q_{GD}			7.5		
Gate-Resistance	R_G		$f = 1\text{ MHz}$		5.7	

SWITCHING CHARACTERISTICS (Notes 4, 5)

Turn-On Delay Time	$t_{d(ON)}$	$V_{GS} = -5/20\text{ V}, V_{DS} = 800\text{ V}, I_D = 2\text{ A}, R_G = 25\text{ }\Omega$ inductive load $L = 300\text{ }\mu\text{H}$		5.6		ns
Rise Time	t_r			30		
Turn-Off Delay Time	$t_{d(OFF)}$			11		
Fall Time	t_f			84		μJ
Turn-On Switching Loss	E_{ON}			120		
Turn-Off Switching Loss	E_{OFF}			11		
Total Switching Loss	E_{tot}			131		

DRAIN-SOURCE DIODE CHARACTERISTICS

Continuous Drain-Source Diode Forward Current (Note 1)	I_{SD}	$V_{GS} = -5\text{ V}, T_J = 25^{\circ}\text{C}$		9.5		A
Pulsed Drain-Source Diode Forward Current (Note 2)	I_{SDM}			48		
Forward Diode Voltage	V_{SD}	$V_{GS} = -5\text{ V}, I_{SD} = 2\text{ A}, T_J = 25^{\circ}\text{C}$		4.2		V
Reverse Recovery Time	t_{RR}	$V_{GS} = -5/20\text{ V}, I_{SD} = 2\text{ A}, di/dt = 1000\text{ A}/\mu\text{s}$ (Note 4)		5.9		ns
Reverse Recovery Charge	Q_{RR}			11		nC

Product parametric performance is indicated in the Electrical Characteristics for the listed test conditions, unless otherwise noted. Product performance may not be indicated by the Electrical Characteristics if operated under different conditions.

4. Defined by design, not subject to production test.

5. E_{ON}/E_{OFF} result is with body diode.

NTHL1000N170M1

TYPICAL CHARACTERISTICS

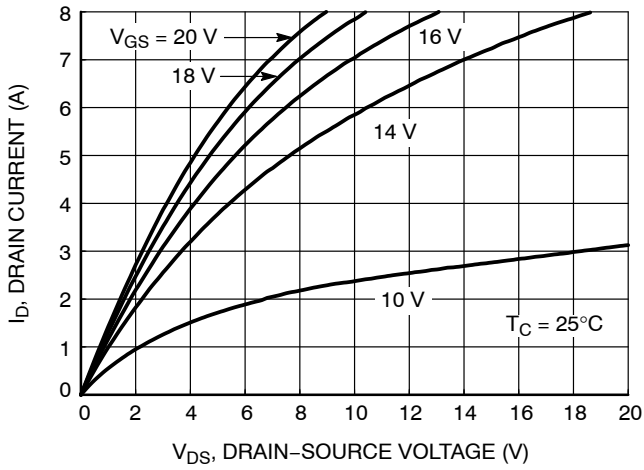

Figure 1. On-Region Characteristics

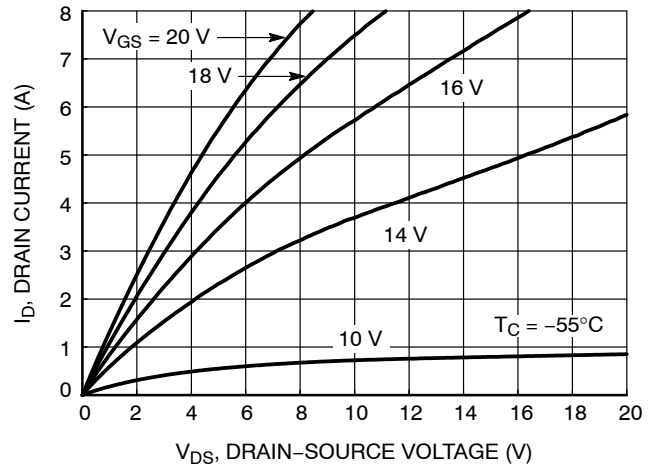

Figure 2. On-Region Characteristics

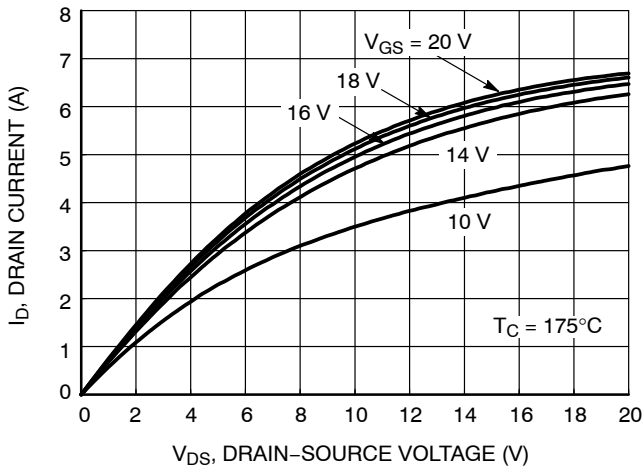

Figure 3. On-Region Characteristics

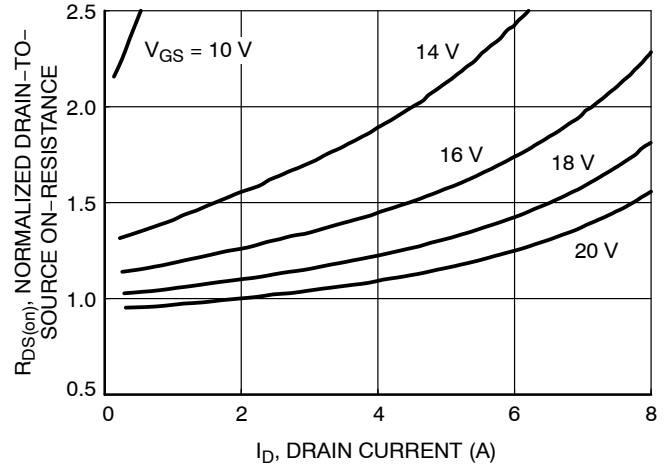

Figure 4. Normalized On-Resistance vs. Drain Current and Gate Voltage

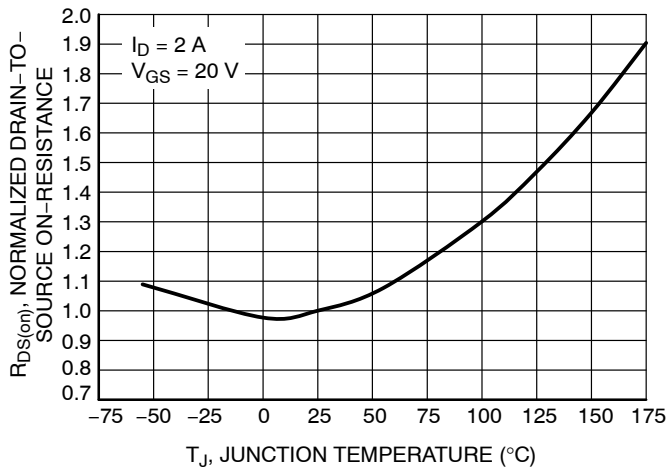

Figure 5. Normalized On-Resistance Variation with Temperature

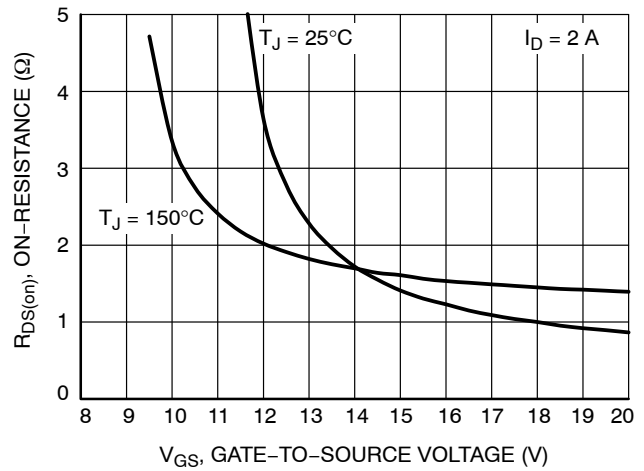

Figure 6. On-Resistance vs. Gate-to-Source Voltage

NTHL1000N170M1

TYPICAL CHARACTERISTICS

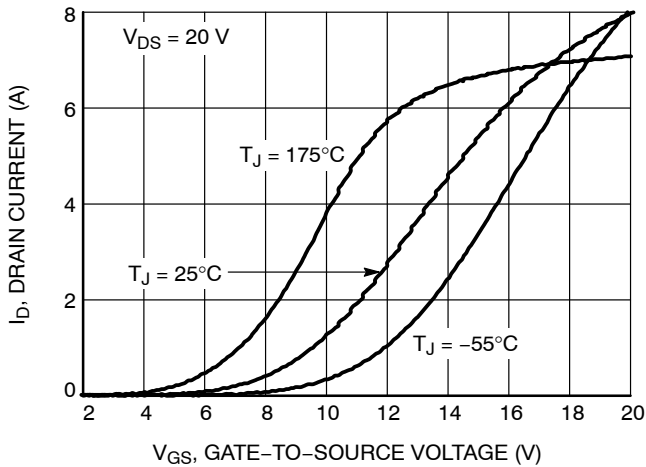

Figure 7. Transfer Characteristics

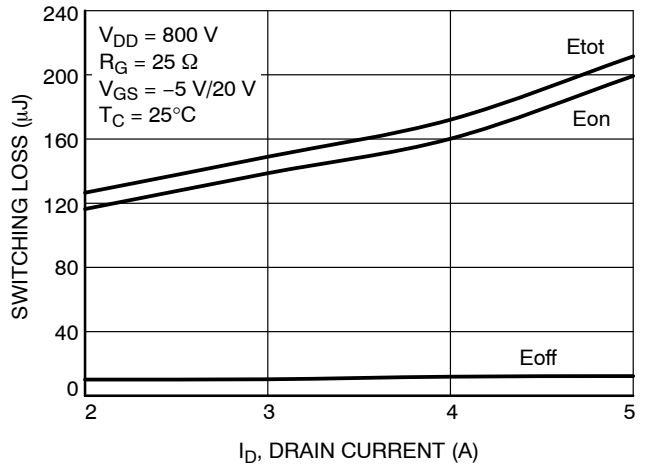

Figure 8. Switching Loss vs. Drain Current

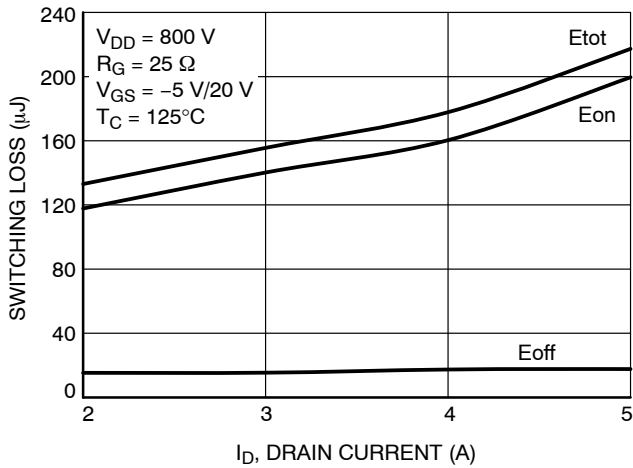

Figure 9. Switching Loss vs. Drain Current

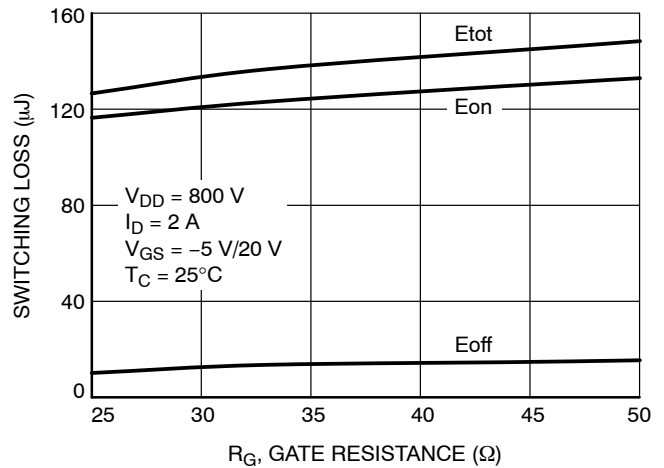

Figure 10. Switching Loss vs. Gate Resistance

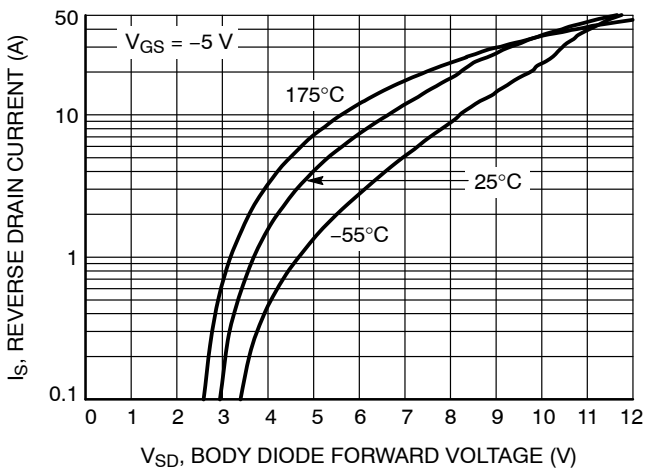

Figure 11. Reverse Drain Current vs. Body Diode Forward Voltage

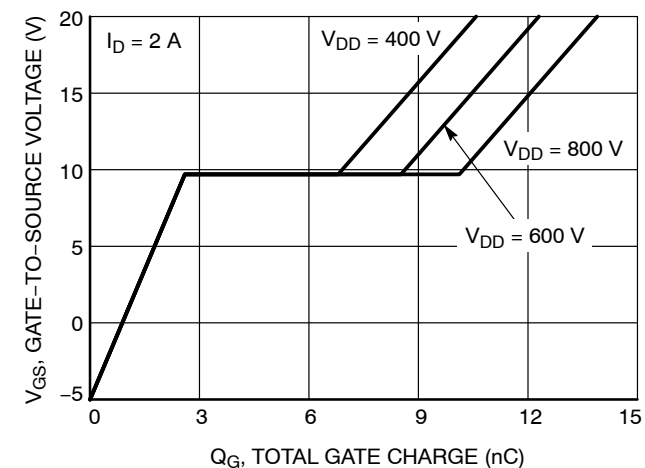

Figure 12. Gate-to-Source Voltage vs. Total Gate Charge

NTHL1000N170M1

TYPICAL CHARACTERISTICS

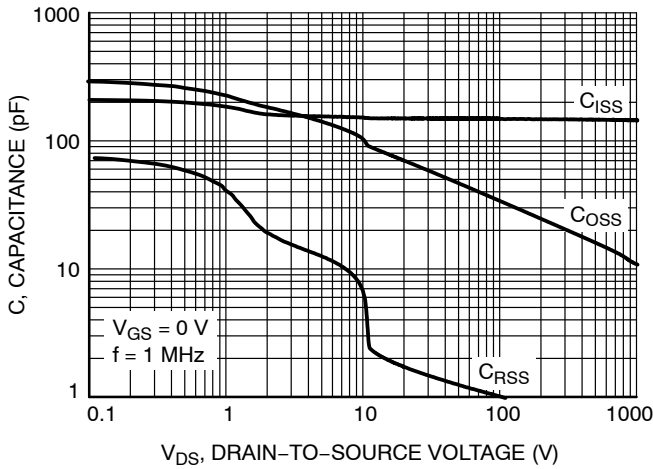

Figure 13. Capacitance vs. Drain-to-Source Voltage

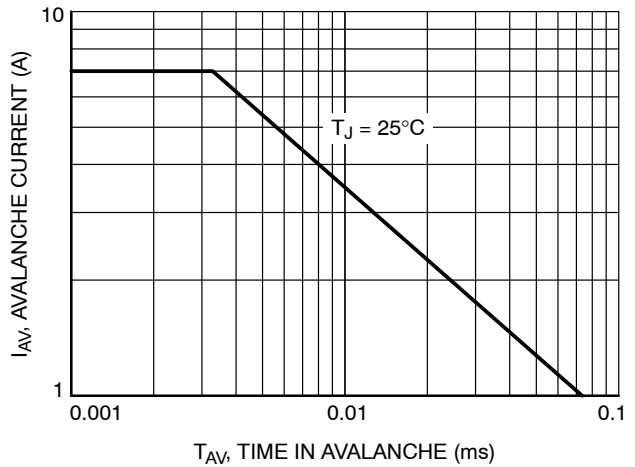

Figure 14. Unclamped Inductive Switching Capability

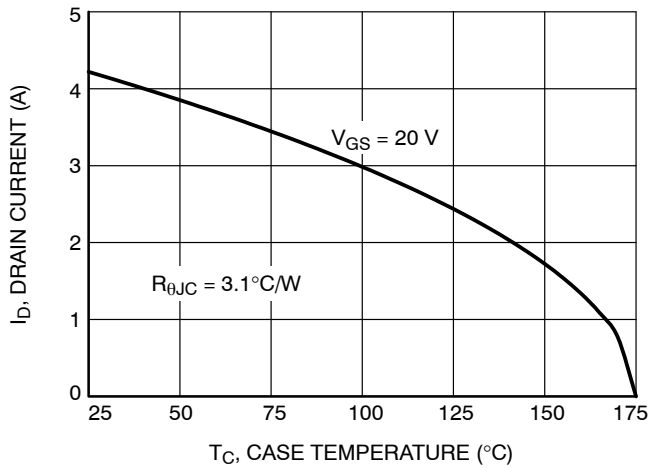

Figure 15. Maximum Continuous Drain Current vs. Case Temperature

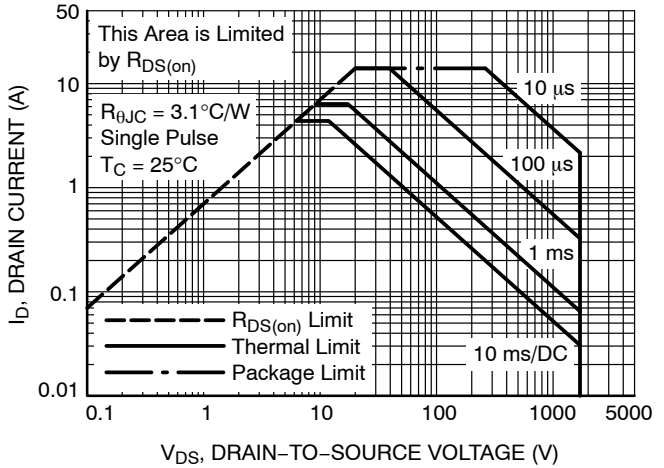

Figure 16. Maximum Rated Forward Biased Safe Operating Area

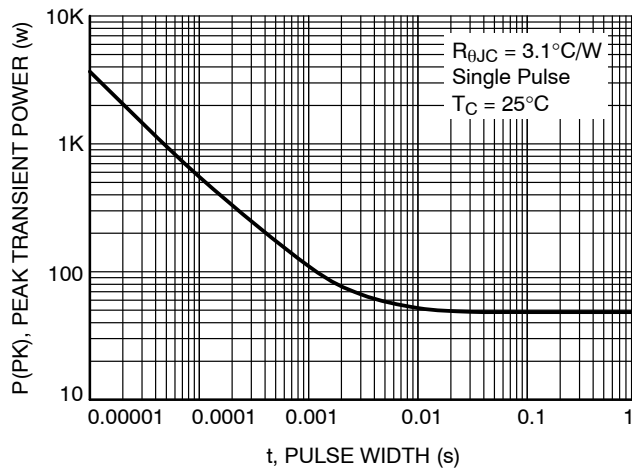

Figure 17. Single Pulse Maximum Power Dissipation

NTHL1000N170M1

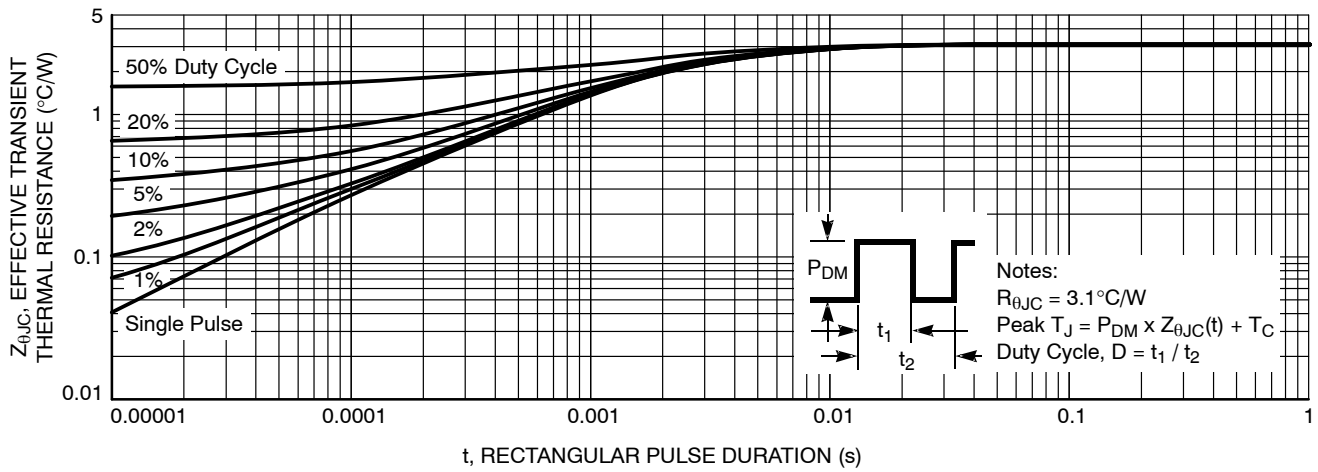

Figure 18. Transient Thermal Impedance

ESD RATINGS

ESD Test	Classification	Standard
ESD-HBM	0B (125 V to <250 V)	ANSI/ESDA/JEDEC JS-001
ESD-CDM	C3 (>1000 V)	ANSI/ESDA/JEDEC JS-002

TO-247-3LD
CASE 340CX
ISSUE A

DATE 06 JUL 2020

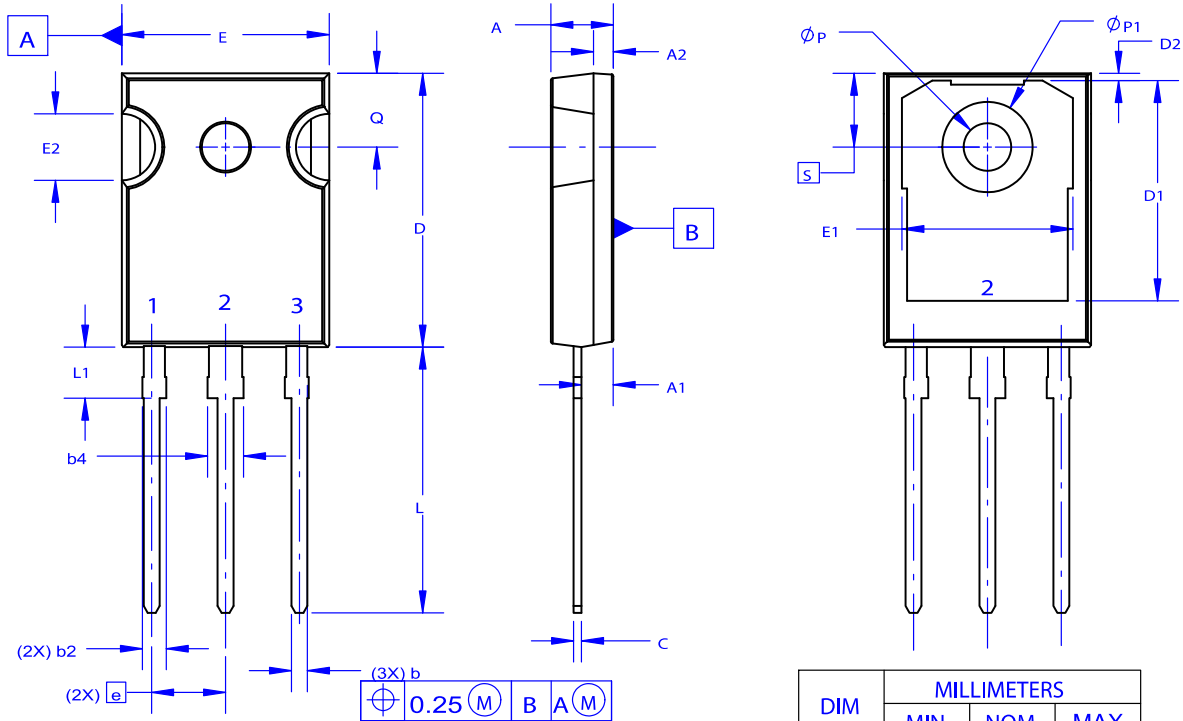
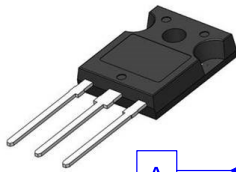

NOTES: UNLESS OTHERWISE SPECIFIED.

- A. DIMENSIONS ARE EXCLUSIVE OF BURRS, MOLD FLASH, AND TIE BAR EXTRUSIONS.
- B. ALL DIMENSIONS ARE IN MILLIMETERS.
- C. DRAWING CONFORMS TO ASME Y14.5 - 2009.
- D. DIMENSION A1 TO BE MEASURED IN THE REGION DEFINED BY L1.
- E. LEAD FINISH IS UNCONTROLLED IN THE REGION DEFINED BY L1.

GENERIC MARKING DIAGRAM*



- XXXXX = Specific Device Code
- A = Assembly Location
- Y = Year
- WW = Work Week
- G = Pb-Free Package

*This information is generic. Please refer to device data sheet for actual part marking. Pb-Free indicator, "G" or microdot "▪", may or may not be present. Some products may not follow the Generic Marking.

DIM	MILLIMETERS		
	MIN	NOM	MAX
A	4.58	4.70	4.82
A1	2.20	2.40	2.60
A2	1.40	1.50	1.60
D	20.32	20.57	20.82
E	15.37	15.62	15.87
E2	4.96	5.08	5.20
e	~	5.56	~
L	19.75	20.00	20.25
L1	3.69	3.81	3.93
ØP	3.51	3.58	3.65
Q	5.34	5.46	5.58
S	5.34	5.46	5.58
b	1.17	1.26	1.35
b2	1.53	1.65	1.77
b4	2.42	2.54	2.66
c	0.51	0.61	0.71
D1	13.08	~	~
D2	0.51	0.93	1.35
E1	12.81	~	~
ØP1	6.60	6.80	7.00

DOCUMENT NUMBER:	98AON93302G	Electronic versions are uncontrolled except when accessed directly from the Document Repository. Printed versions are uncontrolled except when stamped "CONTROLLED COPY" in red.
DESCRIPTION:	TO-247-3LD	PAGE 1 OF 1

onsemi and Onsemi are trademarks of Semiconductor Components Industries, LLC dba onsemi or its subsidiaries in the United States and/or other countries. onsemi reserves the right to make changes without further notice to any products herein. onsemi makes no warranty, representation or guarantee regarding the suitability of its products for any particular purpose, nor does onsemi assume any liability arising out of the application or use of any product or circuit, and specifically disclaims any and all liability, including without limitation special, consequential or incidental damages. onsemi does not convey any license under its patent rights nor the rights of others.

onsemi, **Onsemi**, and other names, marks, and brands are registered and/or common law trademarks of Semiconductor Components Industries, LLC dba "**onsemi**" or its affiliates and/or subsidiaries in the United States and/or other countries. **onsemi** owns the rights to a number of patents, trademarks, copyrights, trade secrets, and other intellectual property. A listing of **onsemi**'s product/patent coverage may be accessed at www.onsemi.com/site/pdf/Patent-Marking.pdf. **onsemi** reserves the right to make changes at any time to any products or information herein, without notice. The information herein is provided "as-is" and **onsemi** makes no warranty, representation or guarantee regarding the accuracy of the information, product features, availability, functionality, or suitability of its products for any particular purpose, nor does **onsemi** assume any liability arising out of the application or use of any product or circuit, and specifically disclaims any and all liability, including without limitation special, consequential or incidental damages. Buyer is responsible for its products and applications using **onsemi** products, including compliance with all laws, regulations and safety requirements or standards, regardless of any support or applications information provided by **onsemi**. "Typical" parameters which may be provided in **onsemi** data sheets and/or specifications can and do vary in different applications and actual performance may vary over time. All operating parameters, including "Typicals" must be validated for each customer application by customer's technical experts. **onsemi** does not convey any license under any of its intellectual property rights nor the rights of others. **onsemi** products are not designed, intended, or authorized for use as a critical component in life support systems or any FDA Class 3 medical devices or medical devices with a same or similar classification in a foreign jurisdiction or any devices intended for implantation in the human body. Should Buyer purchase or use **onsemi** products for any such unintended or unauthorized application, Buyer shall indemnify and hold **onsemi** and its officers, employees, subsidiaries, affiliates, and distributors harmless against all claims, costs, damages, and expenses, and reasonable attorney fees arising out of, directly or indirectly, any claim of personal injury or death associated with such unintended or unauthorized use, even if such claim alleges that **onsemi** was negligent regarding the design or manufacture of the part. **onsemi** is an Equal Opportunity/Affirmative Action Employer. This literature is subject to all applicable copyright laws and is not for resale in any manner.

ADDITIONAL INFORMATION

TECHNICAL PUBLICATIONS:

Technical Library: www.onsemi.com/design/resources/technical-documentation
onsemi Website: www.onsemi.com

ONLINE SUPPORT: www.onsemi.com/support

For additional information, please contact your local Sales Representative at www.onsemi.com/support/sales