

MOSFET - Power, Single N-Channel, DFNW8 80 V, 1.56 mΩ, 287 A



ON Semiconductor®

www.onsemi.com

NTMTS1D5N08MC

Features

- Small Footprint (8x8 mm) for Compact Design
- Low $R_{DS(on)}$ to Minimize Conduction Losses
- Low Q_G and Capacitance to Minimize Driver Losses
- These Devices are Pb-Free, Halogen Free/BFR Free and are RoHS Compliant

Typical Applications

- Power Tools, Battery Operated Vacuums
- UAV/Drones, Material Handling
- BMS/Storage, Home Automation

MAXIMUM RATINGS ($T_J = 25^\circ\text{C}$ unless otherwise noted)

Parameter		Symbol	Value	Unit	
Drain-to-Source Voltage		V_{DSS}	80	V	
Gate-to-Source Voltage		V_{GS}	± 20	V	
Continuous Drain Current $R_{\theta JC}$ (Note 2)	Steady State	$T_C = 25^\circ\text{C}$	I_D	287	A
			P_D	250	W
Continuous Drain Current $R_{\theta JA}$ (Notes 1, 2)	Steady State	$T_A = 25^\circ\text{C}$	I_D	33	A
			P_D	3.3	W
Pulsed Drain Current	$T_C = 25^\circ\text{C}, t_p = 10 \mu\text{s}$	I_{DM}	3500	A	
Operating Junction and Storage Temperature Range		T_J, T_{stg}	-55 to +150	$^\circ\text{C}$	
Single Pulse Drain-to-Source Avalanche Energy ($I_{L(pk)} = 31 \text{ A}, L = 3 \text{ mH}$)		E_{AS}	1441	mJ	
Lead Temperature for Soldering Purposes (1/8" from case for 10 s)		T_L	260	$^\circ\text{C}$	

Stresses exceeding those listed in the Maximum Ratings table may damage the device. If any of these limits are exceeded, device functionality should not be assumed, damage may occur and reliability may be affected.

THERMAL RESISTANCE MAXIMUM RATINGS

Parameter	Symbol	Value	Unit
Junction-to-Case - Steady State (Note 2)	$R_{\theta JC}$	0.5	$^\circ\text{C}/\text{W}$
Junction-to-Ambient - Steady State (Note 2)	$R_{\theta JA}$	38	$^\circ\text{C}/\text{W}$

1. Surface-mounted on FR4 board using a 1 in² pad size, 1 oz. Cu pad.
2. The entire application environment impacts the thermal resistance values shown, they are not constants and are only valid for the particular conditions noted.

$V_{(BR)DSS}$	$R_{DS(ON)} \text{ MAX}$	$I_D \text{ MAX}$
80 V	1.56 mΩ @ 10 V	287 A
	4.0 mΩ @ 6 V	

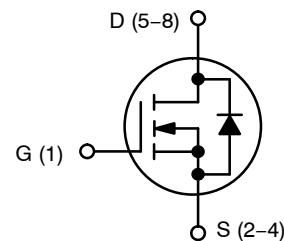

N-CHANNEL MOSFET

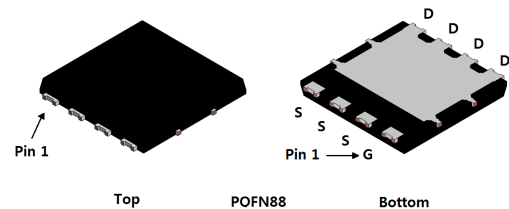

DFNW8
CASE 507AP

MARKING DIAGRAM

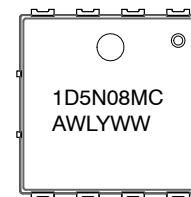

1D5N08MC = Device Code
A = Assembly Location
WL = 2-digit Wafer Lot Code
Y = Year Code
WW = Work Week Code

ORDERING INFORMATION

See detailed ordering, marking and shipping information in the package dimensions section on page 5 of this data sheet.

NTMTS1D5N08MC

ELECTRICAL CHARACTERISTICS ($T_J = 25^\circ\text{C}$ unless otherwise specified)

Parameter	Symbol	Test Condition	Min	Typ	Max	Unit
OFF CHARACTERISTICS						
Drain-to-Source Breakdown Voltage	$V_{(BR)DSS}$	$V_{GS} = 0\text{ V}, I_D = 250\ \mu\text{A}$	80			V
Drain-to-Source Breakdown Voltage Temperature Coefficient	$V_{(BR)DSS}/T_J$	$I_D = 250\ \mu\text{A}$, ref to 25°C		82		mV/ $^\circ\text{C}$
Zero Gate Voltage Drain Current	I_{DSS}	$V_{GS} = 0\text{ V}, V_{DS} = 80\text{ V}$	$T_J = 25^\circ\text{C}$		1	μA
			$T_J = 125^\circ\text{C}$		250	
Gate-to-Source Leakage Current	I_{GSS}	$V_{DS} = 0\text{ V}, V_{GS} = \pm 20\text{ V}$			± 100	nA

ON CHARACTERISTICS (Note 3)

Gate Threshold Voltage	$V_{GS(TH)}$	$V_{GS} = V_{DS}, I_D = 650\ \mu\text{A}$	2.0	3.0	4.0	V
Negative Threshold Temperature Coefficient	$V_{GS(TH)}/T_J$	$I_D = 650\ \mu\text{A}$, ref to 25°C		-8.3		mV/ $^\circ\text{C}$
Drain-to-Source On Resistance	$R_{DS(on)}$	$V_{GS} = 10\text{ V}, I_D = 80\text{ A}$		1.10	1.56	m Ω
Drain-to-Source On Resistance	$R_{DS(on)}$	$V_{GS} = 6\text{ V}, I_D = 58\text{ A}$		1.75	4.0	m Ω
Forward Transconductance	g_{FS}	$V_{DS} = 5\text{ V}, I_D = 80\text{ A}$		219		S
Gate Resistance	R_G	$T_A = 25^\circ\text{C}$		0.9		Ω

CHARGES, CAPACITANCES & GATE RESISTANCE

Input Capacitance	C_{ISS}	$V_{GS} = 0\text{ V}, f = 1\text{ MHz}, V_{DS} = 40\text{ V}$		7420	10,400	pF
Output Capacitance	C_{OSS}			2555	3600	
Reverse Transfer Capacitance	C_{RSS}			101	175	
Total Gate Charge	$Q_{G(TOT)}$	$V_{GS} = 10\text{ V}, V_{DS} = 40\text{ V}; I_D = 80\text{ A}$		101	140	nC
Threshold Gate Charge	$Q_{G(TH)}$			20	28	
Gate-to-Source Charge	Q_{GS}			32		
Gate-to-Drain Charge	Q_{GD}			21		
Output Charge	Q_{OSS}			141		
Sync Charge	Q_{sync}			82		
Plateau Voltage	$V_{plateau}$			5		

SWITCHING CHARACTERISTICS, $V_{GS} = 10\text{ V}$ (Note 3)

Turn-On Delay Time	$t_{d(ON)}$	$V_{GS} = 10\text{ V}, V_{DS} = 40\text{ V}, I_D = 80\text{ A}, R_G = 6\ \Omega$		30		ns
Rise Time	t_r			24		
Turn-Off Delay Time	$t_{d(OFF)}$			69		
Fall Time	t_f			31		

DRAIN-SOURCE DIODE CHARACTERISTICS

Forward Diode Voltage	V_{SD}	$V_{GS} = 0\text{ V}, I_S = 2\text{ A}$		0.7	1.2	V
		$V_{GS} = 0\text{ V}, I_S = 80\text{ A}$		0.8	1.3	
Reverse Recovery Time	t_{RR}	$I_F = 40\text{ A}, di/dt = 300\text{ A}/\mu\text{s}$		39	62	ns
Reverse Recovery Charge	Q_{RR}			89	142	
Reverse Recovery Time	t_{RR}	$I_F = 40\text{ A}, di/dt = 1000\text{ A}/\mu\text{s}$		31	50	nC
Reverse Recovery Charge	Q_{RR}			209	335	

Product parametric performance is indicated in the Electrical Characteristics for the listed test conditions, unless otherwise noted. Product performance may not be indicated by the Electrical Characteristics if operated under different conditions.

3. Switching characteristics are independent of operating junction temperatures.

TYPICAL CHARACTERISTICS

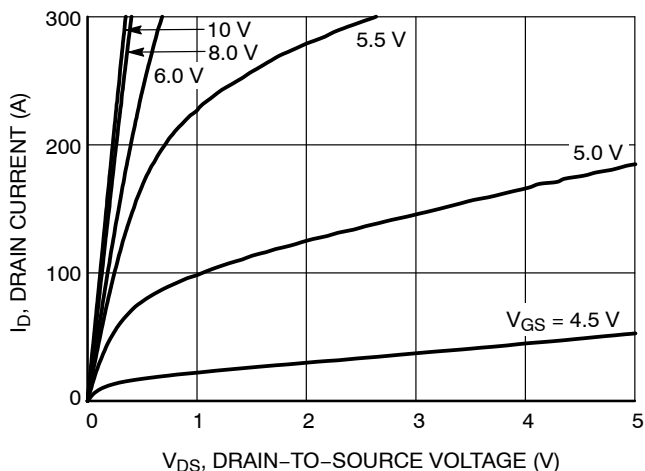

Figure 1. On-Region Characteristics

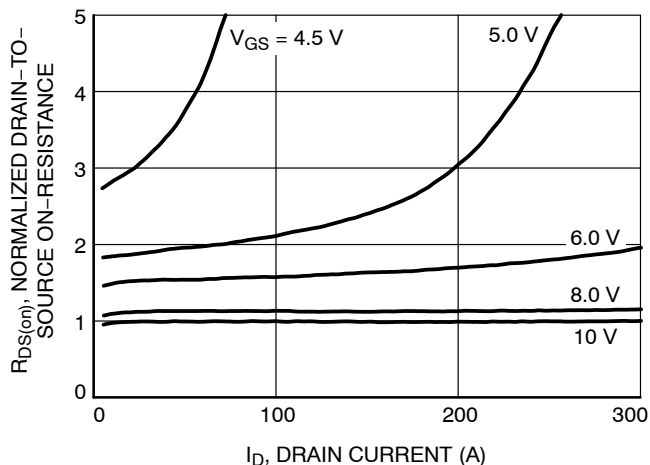

Figure 2. Normalized On-Resistance vs. Drain Current and Gate Voltage

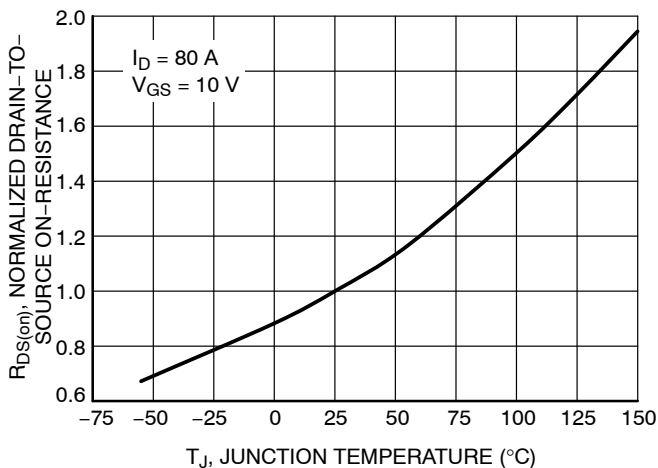

Figure 3. Normalized On Resistance vs. Junction Temperature

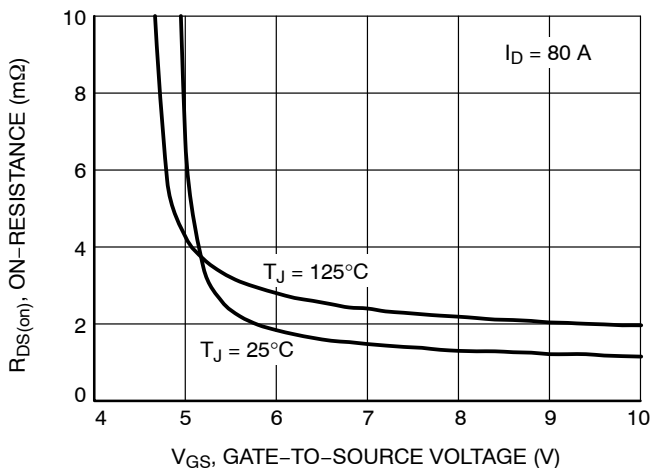

Figure 4. On-Resistance vs. Gate-to-Source Voltage

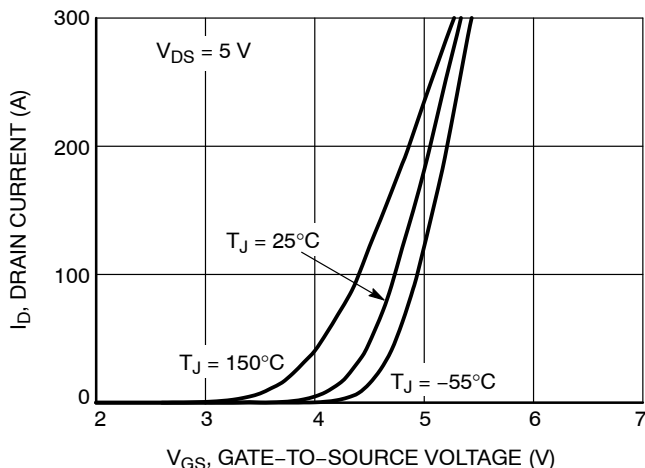

Figure 5. Transfer Characteristics

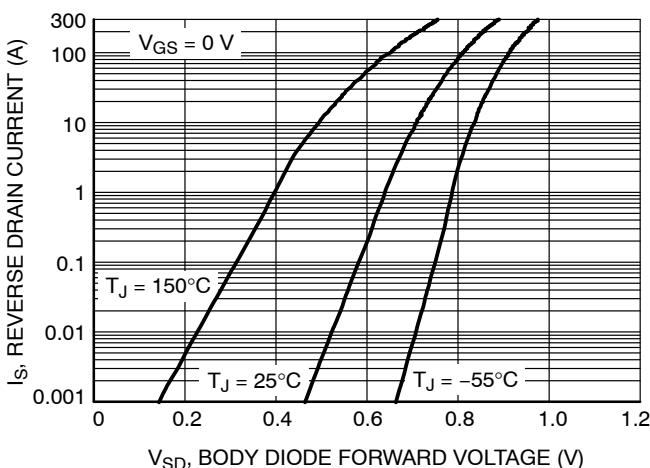

Figure 6. Source-to-Drain Diode Forward Voltage vs. Source Current

NTMTS1D5N08MC

TYPICAL CHARACTERISTICS

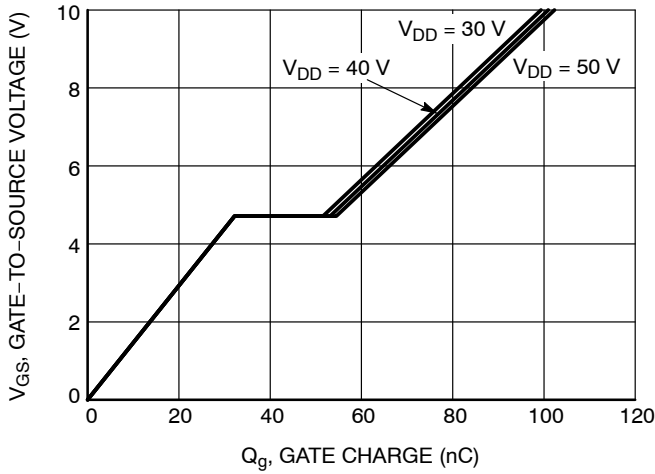

Figure 7. Gate Charge Characteristics

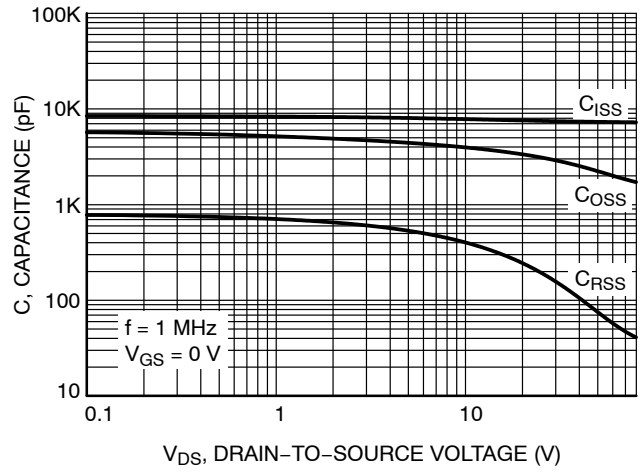

Figure 8. Capacitance vs. Drain-to-Source Voltage

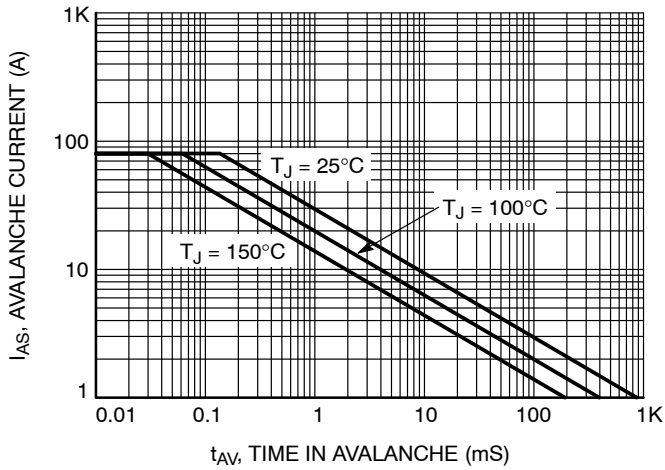

Figure 9. Unclamped Inductive Switching Capability

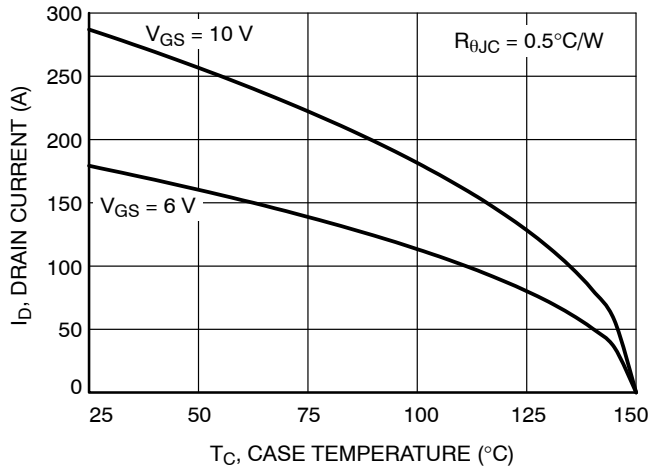

Figure 10. Maximum Continuous Drain Current vs. Case Temperature

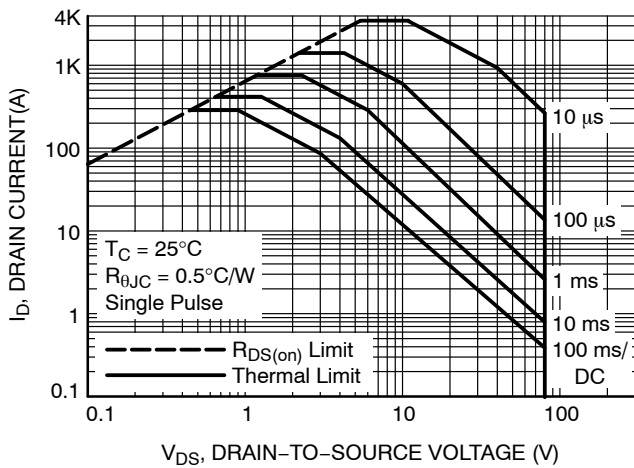

Figure 11. Forward Biased Safe Operating Area

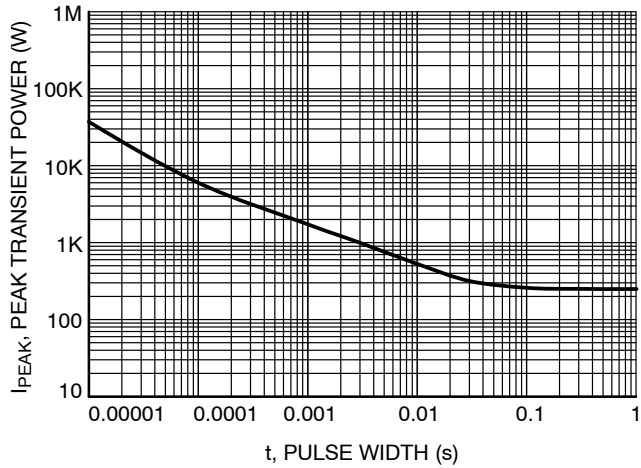

Figure 12. Single Pulse Maximum Power Dissipation

NTMTS1D5N08MC

TYPICAL CHARACTERISTICS

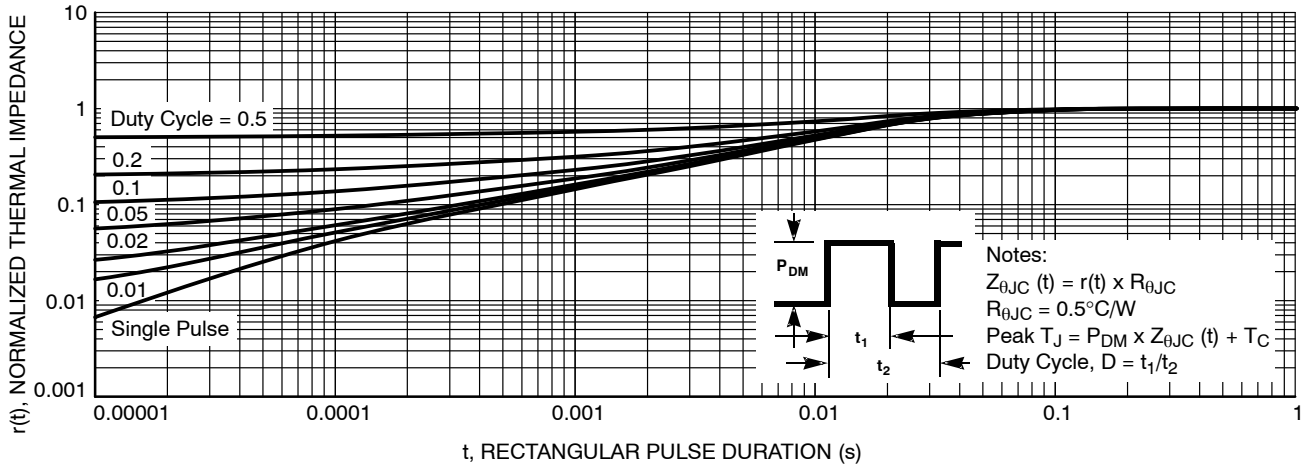

Figure 13. Transient Thermal Impedance

DEVICE ORDERING INFORMATION

Device	Marking	Package	Shipping†
NTMTS1D5N08MC	NTMTS 1D5N08MC	DFNW8 (Pb-Free)	3000 / Tape & Reel

†For information on tape and reel specifications, including part orientation and tape sizes, please refer to our Tape and Reel Packaging Specifications Brochure, BRD8011/D.

MECHANICAL CASE OUTLINE PACKAGE DIMENSIONS

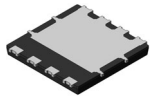

TDFNW8 8.30x8.40x1.10, 2.00P
CASE 507AP
ISSUE E

DATE 08 MAY 2024

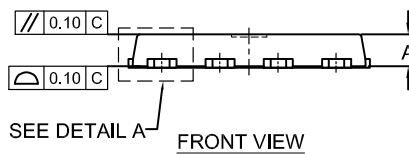
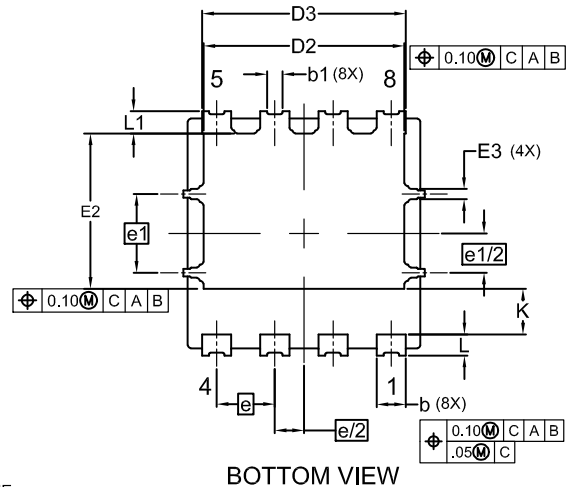
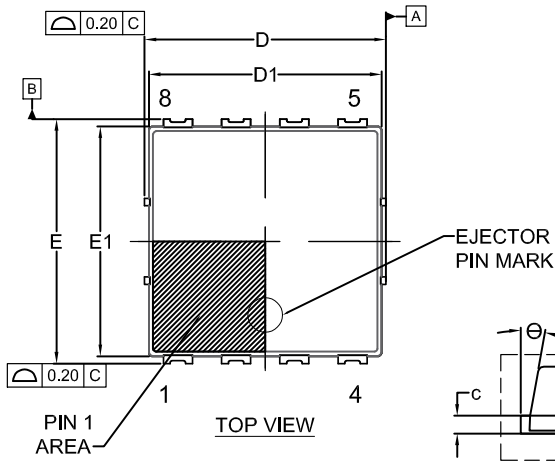

DETAIL A
SCALE: 2X

NOTES:

1. DIMENSIONING AND TOLERANCING PER ASME Y14.5M, 2009.
2. CONTROLLING DIMENSION: MILLIMETERS
3. COPLANARITY APPLIES TO THE EXPOSED PADS AS WELL AS THE TERMINALS.
4. DIMENSIONS D1 AND E1 DO NOT INCLUDE MOLD FLASH, PROTRUSIONS, OR GATE BURRS.
5. SEATING PLANE IS DEFINED BY THE TERMINALS. "A1" IS DEFINED AS THE DISTANCE FROM THE SEATING PLANE TO THE LOWEST POINT ON THE PACKAGE BODY.

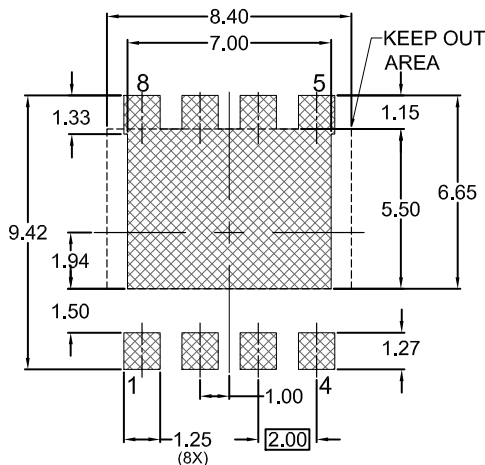

RECOMMENDED LAND PATTERN*

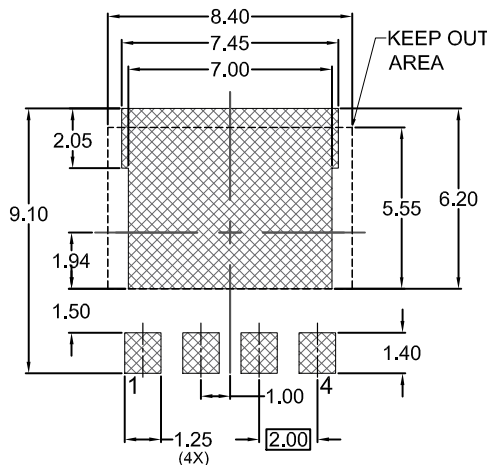

UNIVERSAL LAND PATTERN*

DIM	MILLIMETERS		
	MIN.	NOM.	MAX.
A	1.00	1.10	1.20
A1	0.00	—	0.05
b	0.90	1.00	1.10
b1	0.35	0.45	0.55
c	0.23	0.28	0.33
D	8.20	8.30	8.40
D1	7.90	8.00	8.10
D2	6.80	6.90	7.00
D3	6.90	7.00	7.10
E	8.30	8.40	8.50
E1	7.80	7.90	8.00
E2	5.24	5.34	5.44
E3	0.25	0.35	0.45
e	2.00 BSC		
e/2	1.00 BSC		
e1	2.70 BSC		
e1/2	1.35 BSC		
K	1.50	1.57	1.70
L	0.64	0.74	0.84
L1	0.67	0.77	0.87
θ	0°	—	12°

*FOR ADDITIONAL INFORMATION ON OUR PB-FREE STRATEGY AND SOLDERING DETAILS, PLEASE DOWNLOAD THE ONSEMI SOLDERING AND MOUNTING TECHNIQUES REFERENCE MANUAL, SOLDERRM/D.

DOCUMENT NUMBER:	98AON80534G	Electronic versions are uncontrolled except when accessed directly from the Document Repository. Printed versions are uncontrolled except when stamped "CONTROLLED COPY" in red.
DESCRIPTION:	TDFNW8 8.30x8.40x1.10, 2.00P	PAGE 1 OF 2

onsemi and ONSEMI are trademarks of Semiconductor Components Industries, LLC dba onsemi or its subsidiaries in the United States and/or other countries. onsemi reserves the right to make changes without further notice to any products herein. onsemi makes no warranty, representation or guarantee regarding the suitability of its products for any particular purpose, nor does onsemi assume any liability arising out of the application or use of any product or circuit, and specifically disclaims any and all liability, including without limitation special, consequential or incidental damages. onsemi does not convey any license under its patent rights nor the rights of others.

TDFNW8 8.30x8.40x1.10, 2.00P
CASE 507AP
ISSUE E

DATE 08 MAY 2024

GENERIC MARKING DIAGRAM*

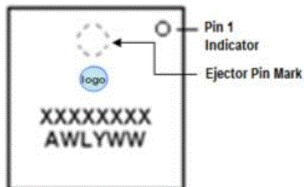

- XXXX = Specific Device Code
- A = Assembly Location
- WL = Wafer Lot Code
- Y = Year Code
- WW = Work Week Code

*This information is generic. Please refer to device data sheet for actual part marking. Pb-Free indicator, "G" or microdot "▪", may or may not be present. Some products may not follow the Generic Marking.

DOCUMENT NUMBER:	98AON80534G	Electronic versions are uncontrolled except when accessed directly from the Document Repository. Printed versions are uncontrolled except when stamped "CONTROLLED COPY" in red.
DESCRIPTION:	TDFNW8 8.30x8.40x1.10, 2.00P	PAGE 2 OF 2

onsemi and **ONSEMI** are trademarks of Semiconductor Components Industries, LLC dba **onsemi** or its subsidiaries in the United States and/or other countries. **onsemi** reserves the right to make changes without further notice to any products herein. **onsemi** makes no warranty, representation or guarantee regarding the suitability of its products for any particular purpose, nor does **onsemi** assume any liability arising out of the application or use of any product or circuit, and specifically disclaims any and all liability, including without limitation special, consequential or incidental damages. **onsemi** does not convey any license under its patent rights nor the rights of others.

www.onsemi.com

onsemi, **Onsemi**, and other names, marks, and brands are registered and/or common law trademarks of Semiconductor Components Industries, LLC dba "**onsemi**" or its affiliates and/or subsidiaries in the United States and/or other countries. **onsemi** owns the rights to a number of patents, trademarks, copyrights, trade secrets, and other intellectual property. A listing of **onsemi**'s product/patent coverage may be accessed at www.onsemi.com/site/pdf/Patent-Marking.pdf. **onsemi** reserves the right to make changes at any time to any products or information herein, without notice. The information herein is provided "as-is" and **onsemi** makes no warranty, representation or guarantee regarding the accuracy of the information, product features, availability, functionality, or suitability of its products for any particular purpose, nor does **onsemi** assume any liability arising out of the application or use of any product or circuit, and specifically disclaims any and all liability, including without limitation special, consequential or incidental damages. Buyer is responsible for its products and applications using **onsemi** products, including compliance with all laws, regulations and safety requirements or standards, regardless of any support or applications information provided by **onsemi**. "Typical" parameters which may be provided in **onsemi** data sheets and/or specifications can and do vary in different applications and actual performance may vary over time. All operating parameters, including "Typicals" must be validated for each customer application by customer's technical experts. **onsemi** does not convey any license under any of its intellectual property rights nor the rights of others. **onsemi** products are not designed, intended, or authorized for use as a critical component in life support systems or any FDA Class 3 medical devices or medical devices with a same or similar classification in a foreign jurisdiction or any devices intended for implantation in the human body. Should Buyer purchase or use **onsemi** products for any such unintended or unauthorized application, Buyer shall indemnify and hold **onsemi** and its officers, employees, subsidiaries, affiliates, and distributors harmless against all claims, costs, damages, and expenses, and reasonable attorney fees arising out of, directly or indirectly, any claim of personal injury or death associated with such unintended or unauthorized use, even if such claim alleges that **onsemi** was negligent regarding the design or manufacture of the part. **onsemi** is an Equal Opportunity/Affirmative Action Employer. This literature is subject to all applicable copyright laws and is not for resale in any manner.

ADDITIONAL INFORMATION

TECHNICAL PUBLICATIONS:

Technical Library: www.onsemi.com/design/resources/technical-documentation
onsemi Website: www.onsemi.com

ONLINE SUPPORT: www.onsemi.com/support

For additional information, please contact your local Sales Representative at www.onsemi.com/support/sales