

Silicon Carbide (SiC) MOSFET – EliteSiC, 22 mohm, 1200 V, M3S, D²PAK-7L

NVBG022N120M3S

Features

- Typ. $R_{DS(on)} = 22\text{ m}\Omega @ V_{GS} = 18\text{ V}$
- Ultra Low Gate Charge ($Q_{G(tot)} = 142\text{ nC}$)
- High Speed Switching with Low Capacitance ($C_{oss} = 146\text{ pF}$)
- 100% Avalanche Tested
- AEC-Q101 Qualified and PPAP Capable
- These Devices are RoHS Compliant

Typical Applications

- Automotive On Board Charger
- Automotive DC/DC Converter for EV/HEV

MAXIMUM RATINGS ($T_J = 25^\circ\text{C}$ unless otherwise noted)

| Parameter | | Symbol | Value | Unit |
|---|--------------------------|---------------------------|-------------|------------------|
| Drain-to-Source Voltage | | V_{DSS} | 1200 | V |
| Gate-to-Source Voltage | | V_{GS} | -10/+22 | V |
| Recommended Operation Values of Gate-to-Source Voltage | | $T_C < 175^\circ\text{C}$ | V_{GSop} | -3/+18 V |
| Continuous Drain Current (Notes 2, 3) | Steady State | $T_C = 25^\circ\text{C}$ | I_D | 100 A |
| | | | P_D | 441 W |
| Power Dissipation (Note 2) | Steady State | $T_C = 100^\circ\text{C}$ | I_D | 71 A |
| | | | P_D | 220 W |
| Pulsed Drain Current (Note 4) | $T_C = 25^\circ\text{C}$ | | I_{DM} | 297 A |
| Operating Junction and Storage Temperature Range | | T_J, T_{stg} | -55 to +175 | $^\circ\text{C}$ |
| Source Current (Body Diode) $T_C = 25^\circ\text{C}, V_{GS} = -3\text{ V}$ (Note 2) | | I_S | 89 | A |
| Single Pulse Drain-to-Source Avalanche Energy ($I_{L(pk)} = 23.1\text{ A}, L = 1\text{ mH}$) (Note 5) | | E_{AS} | 267 | mJ |
| Maximum Temperature for Soldering (10 s) | | T_L | 270 | $^\circ\text{C}$ |

Stresses exceeding those listed in the Maximum Ratings table may damage the device. If any of these limits are exceeded, device functionality should not be assumed, damage may occur and reliability may be affected.

1. Surface mounted on a FR-4 board using 1 in² pad of 2 oz copper.
2. The entire application environment impacts the thermal resistance values shown, they are not constants and are only valid for the particular conditions noted.
3. The maximum current rating is based on typical $R_{DS(on)}$ performance.
4. Repetitive rating, limited by max junction temperature.
5. E_{AS} of 264 mJ is based on starting $T_J = 25^\circ\text{C}$; $L = 1\text{ mH}$, $I_{AS} = 23.1\text{ A}$, $V_{DD} = 100\text{ V}$, $V_{GS} = 18\text{ V}$.

| $V_{(BR)DSS}$ | $R_{DS(ON)}\text{ MAX}$ | $I_D\text{ MAX}$ |
|---------------|-------------------------|------------------|
| 1200 V | 30 m Ω @ 18 V | 100 A |

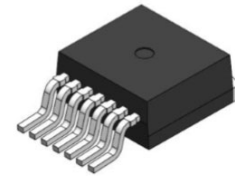
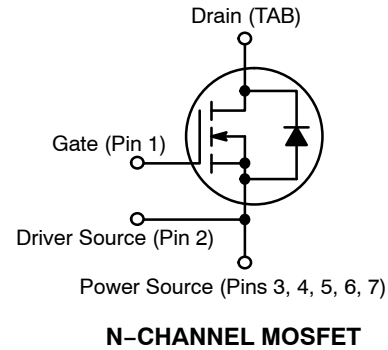

**D²PAK-7L
CASE 418BJ**

MARKING DIAGRAM

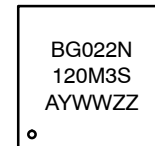

BG022N120M3S = Specific Device Code
 A = Assembly Location
 Y = Year
 WW = Work Week
 ZZ = Lot Traceability

ORDERING INFORMATION

| Device | Package | Shipping |
|----------------|-----------------------|-------------------|
| NVBG022N120M3S | D ² PAK-7L | 800 / Tape & Reel |

NVBG022N120M3S

THERMAL CHARACTERISTICS

| Parameter | Symbol | Max | Unit |
|---|-----------------|------|------|
| Junction-to-Case – Steady State (Note 2) | $R_{\theta JC}$ | 0.34 | °C/W |
| Junction-to-Ambient – Steady State (Notes 1, 2) | $R_{\theta JA}$ | 40 | |

ELECTRICAL CHARACTERISTICS ($T_J = 25^\circ\text{C}$ unless otherwise specified)

| Parameter | Symbol | Test Condition | Min | Typ | Max | Unit |
|-----------|--------|----------------|-----|-----|-----|------|
|-----------|--------|----------------|-----|-----|-----|------|

OFF-STATE CHARACTERISTICS

| | | | | | | |
|---|-------------------|---|------|-----|---------|---------------|
| Drain-to-Source Breakdown Voltage | $V_{(BR)DSS}$ | $V_{GS} = 0\text{ V}, I_D = 1\text{ mA}$ | 1200 | - | - | V |
| Drain-to-Source Breakdown Voltage Temperature Coefficient | $V_{(BR)DSS}/T_J$ | $I_D = 1\text{ mA}$, referenced to 25°C (Note 7) | - | 0.3 | - | V/°C |
| Zero Gate Voltage Drain Current | I_{DSS} | $V_{GS} = 0\text{ V}, V_{DS} = 1200\text{ V}$ | - | - | 100 | μA |
| Gate-to-Source Leakage Current | I_{GSS} | $V_{GS} = +22/-10\text{ V}, V_{DS} = 0\text{ V}$ | - | - | ± 1 | μA |

ON-STATE CHARACTERISTICS

| | | | | | | |
|-------------------------------|--------------|---|------|------|-----|------------|
| Gate Threshold Voltage | $V_{GS(TH)}$ | $V_{GS} = V_{DS}, I_D = 20\text{ mA}$ | 2.04 | 2.72 | 4.4 | V |
| Recommended Gate Voltage | V_{GOP} | | -3 | - | +18 | V |
| Drain-to-Source On Resistance | $R_{DS(on)}$ | $V_{GS} = 18\text{ V}, I_D = 40\text{ A}, T_J = 25^\circ\text{C}$ | - | 22 | 30 | m Ω |
| | | $V_{GS} = 18\text{ V}, I_D = 40\text{ A}, T_J = 175^\circ\text{C}$ (Note 7) | - | 44 | - | |
| Forward Transconductance | g_{FS} | $V_{DS} = 10\text{ V}, I_D = 40\text{ A}$ (Note 7) | - | 34 | - | S |

CHARGES, CAPACITANCES & GATE RESISTANCE

| | | | | | | |
|------------------------------|--------------|--|---|------|---|----------|
| Input Capacitance | C_{ISS} | $V_{GS} = 0\text{ V}, f = 1\text{ MHz}, V_{DS} = 800\text{ V}$ (Note 7) | - | 3175 | - | pF |
| Output Capacitance | C_{OSS} | | - | 146 | - | |
| Reverse Transfer Capacitance | C_{RSS} | | - | 14 | - | |
| Total Gate Charge | $Q_{G(TOT)}$ | $V_{GS} = -3/18\text{ V}, V_{DS} = 800\text{ V}, I_D = 40\text{ A}$, (Note 7) | - | 142 | - | nC |
| Threshold Gate Charge | $Q_{G(TH)}$ | | - | 11 | - | |
| Gate-to-Source Charge | Q_{GS} | | - | 16 | - | |
| Gate-to-Drain Charge | Q_{GD} | | - | 38 | - | |
| Gate-Resistance | R_G | $f = 1\text{ MHz}$ | - | 1.5 | - | Ω |

SWITCHING CHARACTERISTICS

| | | | | | | |
|-------------------------|--------------|---|---|-----|---|---------------|
| Turn-On Delay Time | $t_{d(ON)}$ | $V_{GS} = -3/18\text{ V}, V_{DS} = 800\text{ V}, I_D = 40\text{ A}, R_G = 4.5\ \Omega$ inductive load (Notes 6, 7) | - | 18 | - | ns |
| Rise Time | t_r | | - | 24 | - | |
| Turn-Off Delay Time | $t_{d(OFF)}$ | | - | 47 | - | |
| Fall Time | t_f | | - | 14 | - | |
| Turn-On Switching Loss | E_{ON} | | - | 485 | - | μJ |
| Turn-Off Switching Loss | E_{OFF} | | - | 220 | - | |
| Total Switching Loss | E_{tot} | | - | 705 | - | |

SOURCE-DRAIN DIODE CHARACTERISTICS

| | | | | | | |
|--|-----------|--|---|-----|-----|---|
| Continuous Source-Drain Diode Forward Current (Note 2) | I_{SD} | $V_{GS} = -3\text{ V}, T_C = 25^\circ\text{C}$ (Note 7) | - | - | 89 | A |
| Pulsed Source-Drain Diode Forward Current (Note 4) | I_{SDM} | | - | - | 297 | |
| Forward Diode Voltage | V_{SD} | $V_{GS} = -3\text{ V}, I_{SD} = 40\text{ A}, T_J = 25^\circ\text{C}$ | - | 4.5 | - | V |

NVBG022N120M3S

ELECTRICAL CHARACTERISTICS ($T_J = 25^\circ\text{C}$ unless otherwise specified) (continued)

| Parameter | Symbol | Test Condition | Min | Typ | Max | Unit |
|---|-----------|--|-----|-----|-----|---------------|
| SOURCE-DRAIN DIODE CHARACTERISTICS | | | | | | |
| Reverse Recovery Time | t_{RR} | $V_{GS} = -3/18\text{ V}, I_{SD} = 40\text{ A},$ $di_S/dt = 1000\text{ A}/\mu\text{s}, V_{DS} = 800\text{ V}$ (Note 7) | - | 23 | - | ns |
| Reverse Recovery Charge | Q_{RR} | | - | 146 | - | nC |
| Reverse Recovery Energy | E_{REC} | | - | 5 | - | μJ |
| Peak Reverse Recovery Current | I_{RRM} | | - | 13 | - | A |
| Charge time | t_A | | - | 13 | - | ns |
| Discharge time | t_B | | - | 10 | - | ns |

Product parametric performance is indicated in the Electrical Characteristics for the listed test conditions, unless otherwise noted. Product performance may not be indicated by the Electrical Characteristics if operated under different conditions.

6. E_{ON}/E_{OFF} result is with body diode

7. Defined by design, not subject to production test.

TYPICAL CHARACTERISTICS

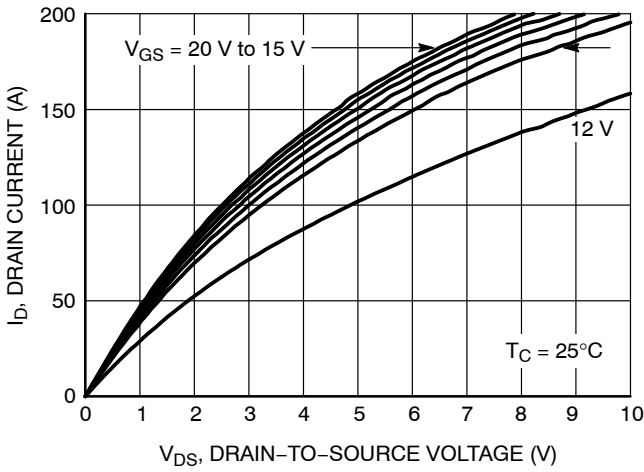

Figure 1. On-Region Characteristics

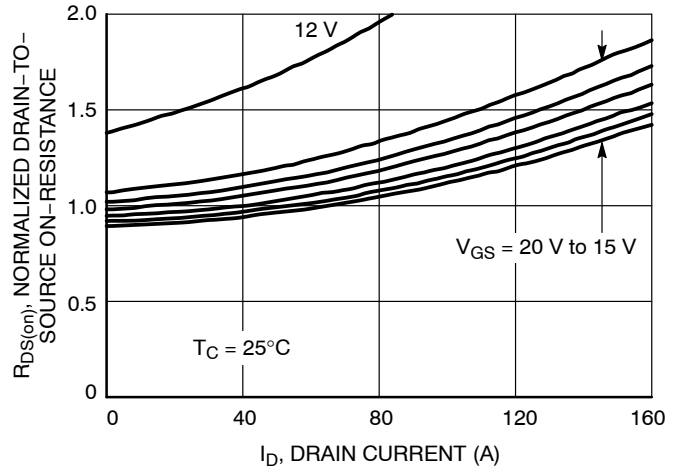

Figure 2. Normalized On-Resistance vs. Drain Current and Gate Voltage

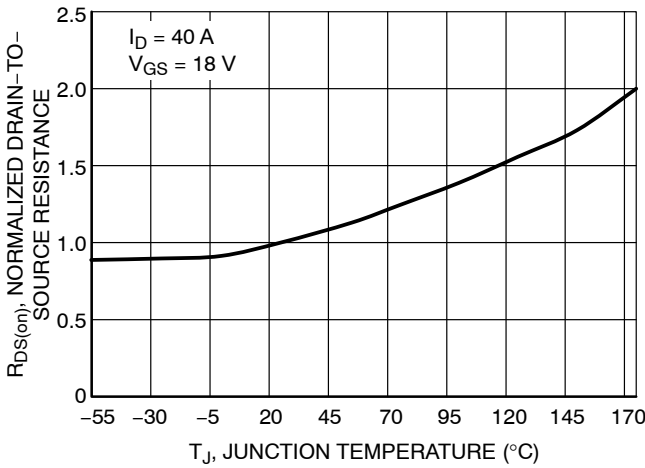

Figure 3. On-Resistance Variation with Temperature

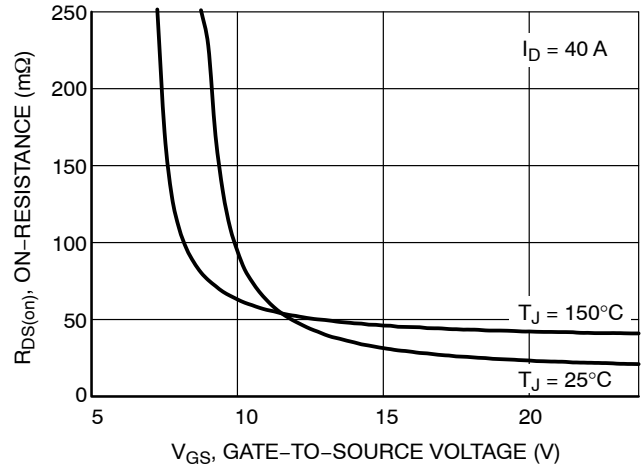

Figure 4. On-Resistance vs. Gate-to-Source Voltage

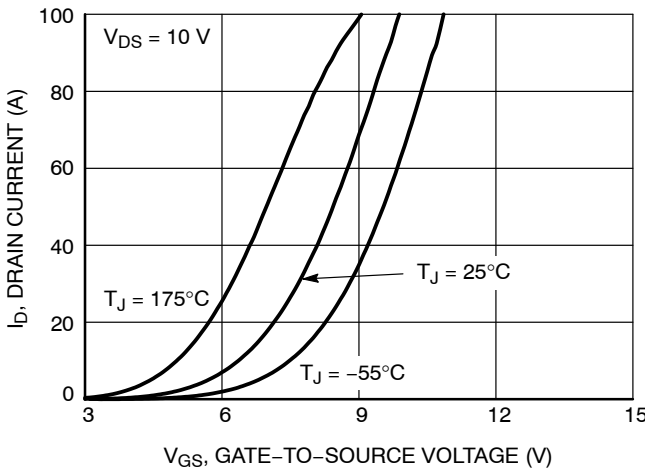

Figure 5. Transfer Characteristics

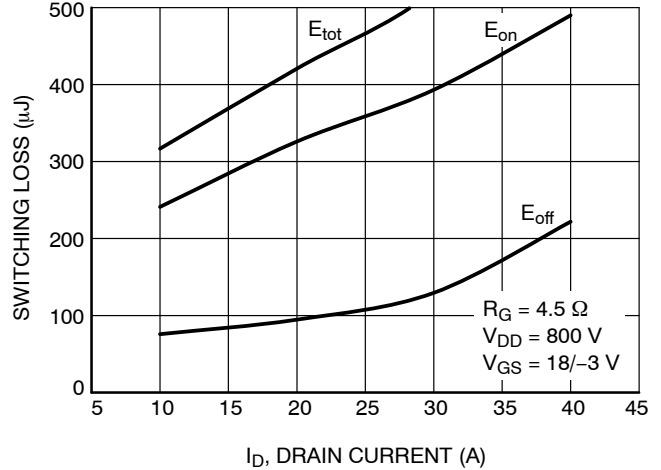

Figure 6. Switching Loss vs. Drain Current

NVBG022N120M3S

TYPICAL CHARACTERISTICS

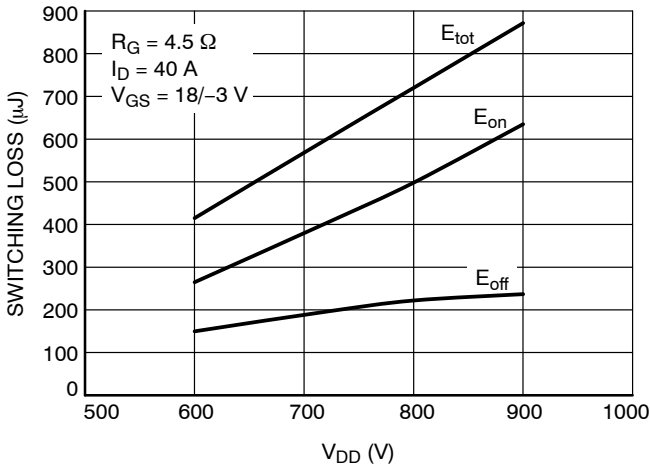

Figure 7. Switching Loss vs. Drain Voltage

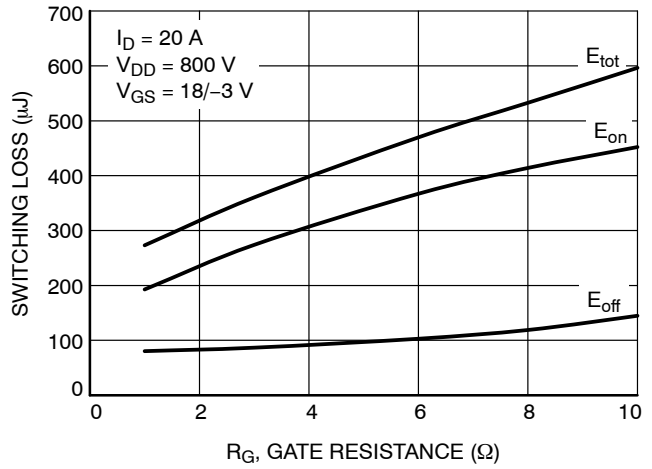

Figure 8. Switching Loss vs. Gate Resistance

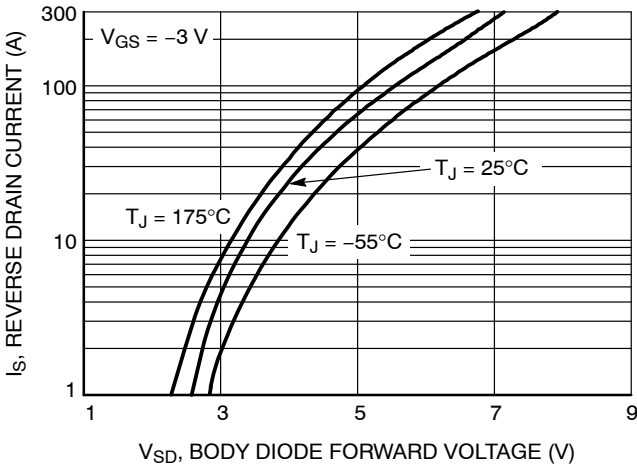

Figure 9. Diode Forward Voltage vs. Current

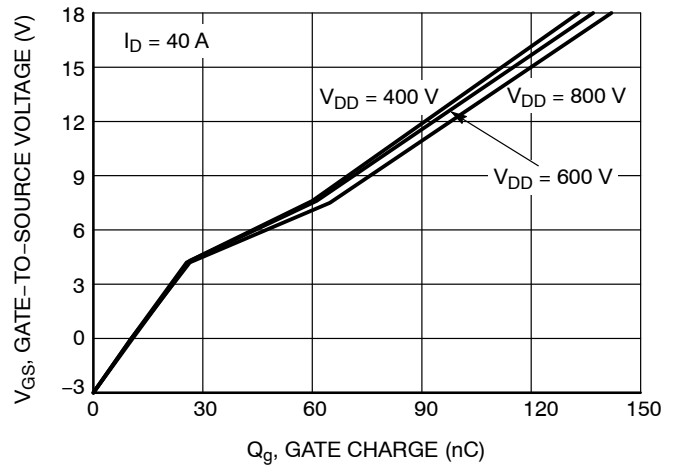

Figure 10. Gate-to-Source Voltage vs. Total Charge

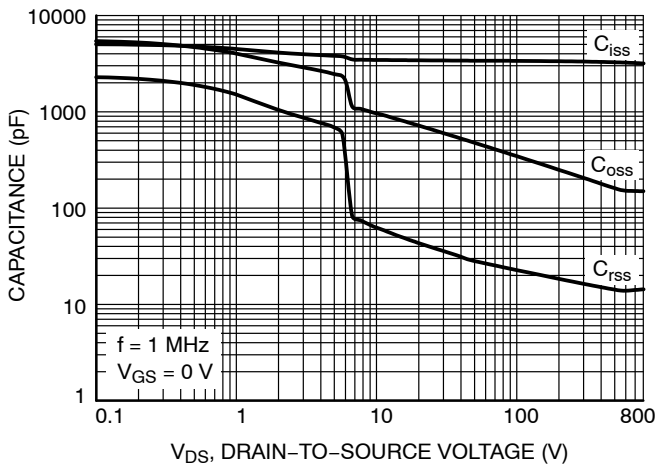

Figure 11. Capacitance vs. Drain-to-Source Voltage

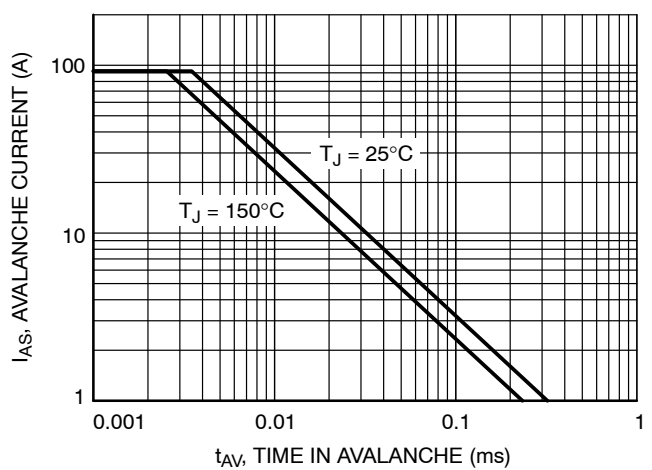

Figure 12. Unclamped Inductive Switching Capability

TYPICAL CHARACTERISTICS

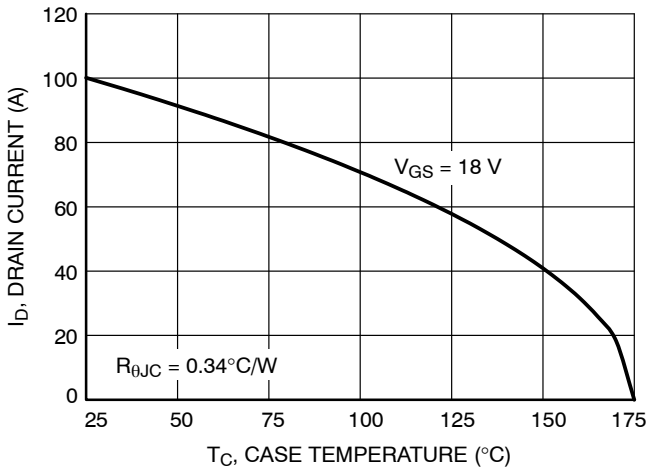

Figure 13. Maximum Continuous Drain Current vs. Case Temperature

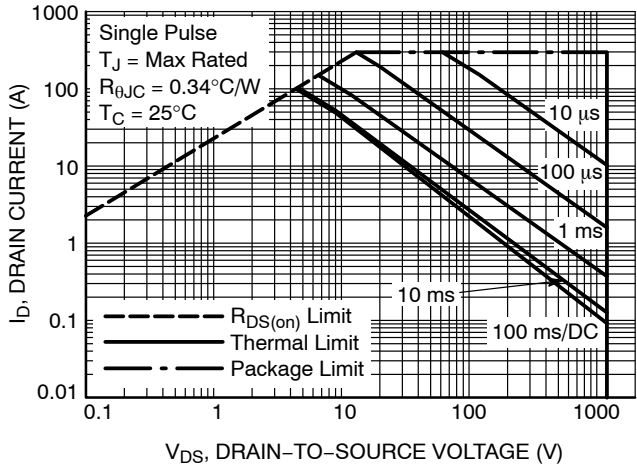

Figure 14. Safe Operating Area

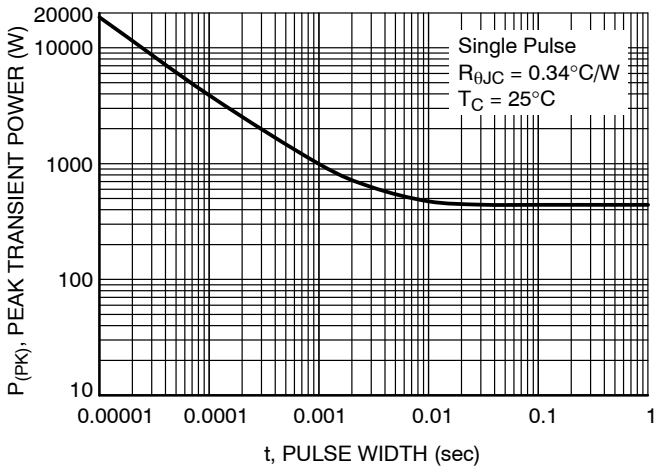

Figure 15. Single Pulse Maximum Power Dissipation

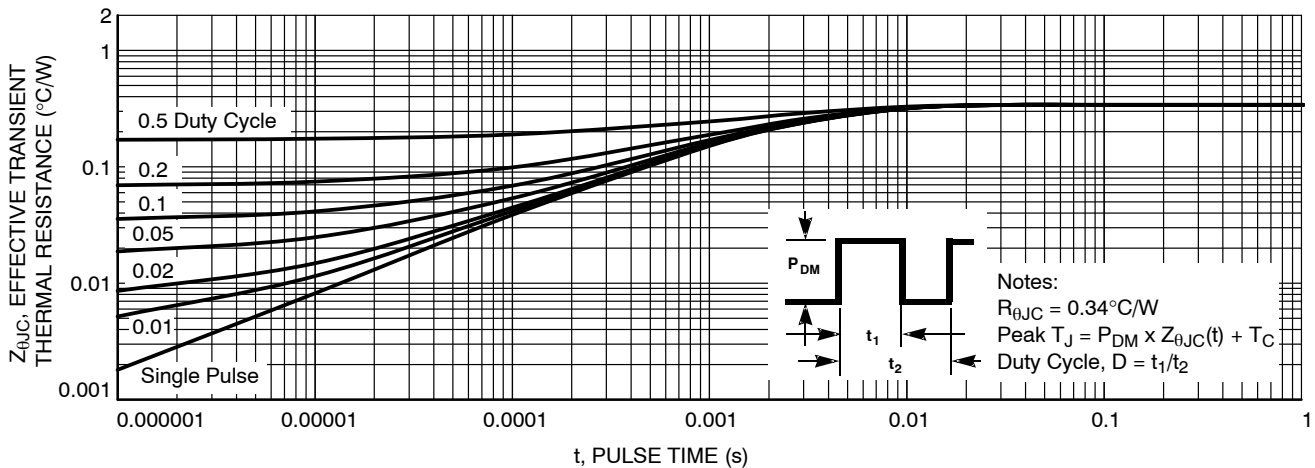
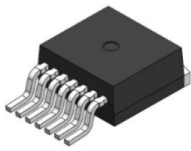

Figure 16. Junction-to-Case Transient Thermal Response

MECHANICAL CASE OUTLINE PACKAGE DIMENSIONS



D²PAK7 (TO-263-7L HV) CASE 418BJ ISSUE B

DATE 16 AUG 2019



NOTES:

- A. PACKAGE CONFORMS TO JEDEC TO-263 VARIATION CB EXCEPT WHERE NOTED.
- B. ALL DIMENSIONS ARE IN MILLIMETERS.
- \triangle OUT OF JEDEC STANDARD VALUE.
- D. DIMENSION AND TOLERANCE AS PER ASME Y14.5-2009.
- E. DIMENSIONS ARE EXCLUSIVE OF BURRS, MOLD FLASH AND TIE BAR PROTRUSIONS.

| DIM | MILLIMETERS | | |
|-----|-------------|-------|-------|
| | MIN | NOM | MAX |
| A | 4.30 | 4.50 | 4.70 |
| A1 | 0.00 | 0.10 | 0.20 |
| b2 | 0.60 | 0.70 | 0.80 |
| b | 0.51 | 0.60 | 0.70 |
| c | 0.40 | 0.50 | 0.60 |
| c2 | 1.20 | 1.30 | 1.40 |
| D | 9.00 | 9.20 | 9.40 |
| D1 | 6.15 | 6.80 | 7.15 |
| E | 9.70 | 9.90 | 10.20 |
| E1 | 7.15 | 7.65 | 8.15 |
| e | ~ | 1.27 | ~ |
| H | 15.10 | 15.40 | 15.70 |
| L | 2.44 | 2.64 | 2.84 |
| L1 | 1.00 | 1.20 | 1.40 |
| L3 | ~ | 0.25 | ~ |
| aaa | ~ | ~ | 0.25 |

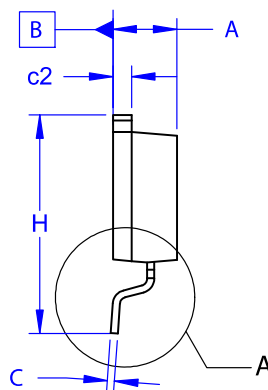

GENERIC MARKING DIAGRAM*



- XXXX = Specific Device Code
- A = Assembly Location
- Y = Year
- WW = Work Week
- G = Pb-Free Package

*This information is generic. Please refer to device data sheet for actual part marking. Pb-Free indicator, "G" or microdot "•", may or may not be present. Some products may not follow the Generic Marking.



| | | |
|-------------------------|---|--|
| DOCUMENT NUMBER: | 98AON84234G | Electronic versions are uncontrolled except when accessed directly from the Document Repository. Printed versions are uncontrolled except when stamped "CONTROLLED COPY" in red. |
| DESCRIPTION: | D²PAK7 (TO-263-7L HV) | PAGE 1 OF 1 |

onsemi and ONSEMI are trademarks of Semiconductor Components Industries, LLC dba onsemi or its subsidiaries in the United States and/or other countries. onsemi reserves the right to make changes without further notice to any products herein. onsemi makes no warranty, representation or guarantee regarding the suitability of its products for any particular purpose, nor does onsemi assume any liability arising out of the application or use of any product or circuit, and specifically disclaims any and all liability, including without limitation special, consequential or incidental damages. onsemi does not convey any license under its patent rights nor the rights of others.

onsemi, **Onsemi**, and other names, marks, and brands are registered and/or common law trademarks of Semiconductor Components Industries, LLC dba "**onsemi**" or its affiliates and/or subsidiaries in the United States and/or other countries. **onsemi** owns the rights to a number of patents, trademarks, copyrights, trade secrets, and other intellectual property. A listing of **onsemi**'s product/patent coverage may be accessed at www.onsemi.com/site/pdf/Patent-Marking.pdf. **onsemi** reserves the right to make changes at any time to any products or information herein, without notice. The information herein is provided "as-is" and **onsemi** makes no warranty, representation or guarantee regarding the accuracy of the information, product features, availability, functionality, or suitability of its products for any particular purpose, nor does **onsemi** assume any liability arising out of the application or use of any product or circuit, and specifically disclaims any and all liability, including without limitation special, consequential or incidental damages. Buyer is responsible for its products and applications using **onsemi** products, including compliance with all laws, regulations and safety requirements or standards, regardless of any support or applications information provided by **onsemi**. "Typical" parameters which may be provided in **onsemi** data sheets and/or specifications can and do vary in different applications and actual performance may vary over time. All operating parameters, including "Typicals" must be validated for each customer application by customer's technical experts. **onsemi** does not convey any license under any of its intellectual property rights nor the rights of others. **onsemi** products are not designed, intended, or authorized for use as a critical component in life support systems or any FDA Class 3 medical devices or medical devices with a same or similar classification in a foreign jurisdiction or any devices intended for implantation in the human body. Should Buyer purchase or use **onsemi** products for any such unintended or unauthorized application, Buyer shall indemnify and hold **onsemi** and its officers, employees, subsidiaries, affiliates, and distributors harmless against all claims, costs, damages, and expenses, and reasonable attorney fees arising out of, directly or indirectly, any claim of personal injury or death associated with such unintended or unauthorized use, even if such claim alleges that **onsemi** was negligent regarding the design or manufacture of the part. **onsemi** is an Equal Opportunity/Affirmative Action Employer. This literature is subject to all applicable copyright laws and is not for resale in any manner.

ADDITIONAL INFORMATION

TECHNICAL PUBLICATIONS:

Technical Library: www.onsemi.com/design/resources/technical-documentation
onsemi Website: www.onsemi.com

ONLINE SUPPORT: www.onsemi.com/support

For additional information, please contact your local Sales Representative at www.onsemi.com/support/sales