

MOSFET - Power, Single N-Channel, STD Gate, SO8FL

40 V, 0.6 mΩ, 384 A

NVMFWS0D63N04XM

MAXIMUM RATINGS (T_J = 25°C unless otherwise stated)

Parameter	Symbol	Value	Unit
Drain-to-Source Voltage	V _{DSS}	40	V
Gate-to-Source Voltage	V _{GS}	±20	V
Continuous Drain Current	I _D	T _C = 25°C	384
		T _C = 100°C	271
Power Dissipation	P _D	157	W
Continuous Drain Current R _{θJA}	I _D	T _C = 25°C	60
		T _C = 100°C	42
Pulsed Drain Current	I _{DM}	900	A
Operating Junction and Storage Temperature Range	T _J , T _{STG}	-55 to 175	°C
Source Current (Body Diode)	I _S	131	A
Single Pulse Avalanche Energy	E _{AS}	585	mJ
Lead Temperature for Soldering Purposes (1/8" from case for 10 s)	T _L	260	°C

Stresses exceeding those listed in the Maximum Ratings table may damage the device. If any of these limits are exceeded, device functionality should not be assumed, damage may occur and reliability may be affected.

THERMAL CHARACTERISTICS

Parameter	Symbol	Value	Unit
Thermal Resistance, Junction-to-Case (Note 2)	R _{θJC}	0.95	°C/W
Thermal Resistance, Junction-to-Ambient (Notes 1, 2)	R _{θJA}	39	

- Surface mounted on FR4 board using 650 mm², 2 oz Cu pad.
- The entire application environment impacts the thermal resistance values shown, they are not constants and are only valid for the particular conditions noted.

V _{(BR)DSS}	R _{DS(on)} MAX	I _D MAX
40 V	0.6 mΩ @ V _{GS} = 10 V	384 A

N-CHANNEL MOSFET

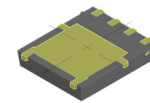
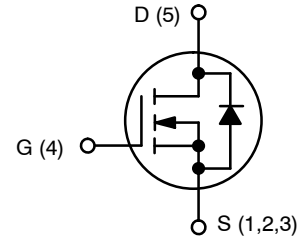

DFNW5 (SO-8FL)
CASE 507BA

MARKING DIAGRAM

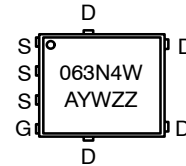

063N4W = Specific Device Code
A = Assembly Location
Y = Year
W = Work Week
ZZ = Lot Traceability

ORDERING INFORMATION

See detailed ordering, marking and shipping information on page 5 of this data sheet.

NVMFWS0D63N04XM

ELECTRICAL CHARACTERISTICS (T_J = 25°C unless otherwise specified)

Parameter	Symbol	Test Condition	Min	Typ	Max	Unit
-----------	--------	----------------	-----	-----	-----	------

OFF CHARACTERISTICS

Drain-to-Source Breakdown Voltage	V _{(BR)DSS}	V _{GS} = 0 V, I _D = 1 mA, T _J = 25°C	40			V
Drain-to-Source Breakdown Voltage Temperature Coefficient	ΔV _{(BR)DSS} /ΔT _J	I _D = 1 mA, Referenced to 25°C		15		mV/°C
Zero Gate Voltage Drain Current	I _{DSS}	V _{DS} = 40 V, T _J = 25°C			10	μA
		V _{DS} = 40 V, T _J = 125°C			100	
Gate-to-Source Leakage Current	I _{GSS}	V _{GS} = 20 V, V _{DS} = 0 V			100	nA

ON CHARACTERISTICS

Drain-to-Source On Resistance	R _{DS(on)}	V _{GS} = 10 V, I _D = 30 A, T _J = 25°C		0.54	0.6	mΩ
Gate Threshold Voltage	V _{GS(TH)}	V _{GS} = V _{DS} , I _D = 230 μA, T _J = 25°C	2.5		3.5	V
Gate Threshold Voltage Temperature Coefficient	ΔV _{GS(TH)} /ΔT _J	V _{GS} = V _{DS} , I _D = 230 μA		-7.24		mV/°C
Forward Trans-conductance	g _{FS}	V _{DS} = 5 V, I _D = 30 A		174		S

CHARGES, CAPACITANCES & GATE RESISTANCE

Input Capacitance	C _{ISS}	V _{DS} = 25 V, V _{GS} = 0 V, f = 1 MHz		5862		pF
Output Capacitance	C _{OSS}			3760		
Reverse Transfer Capacitance	C _{RSS}			50		
Total Gate Charge	Q _{G(TOT)}	V _{DD} = 32 V, I _D = 50 A, V _{GS} = 10 V		92.2		nC
Threshold Gate Charge	Q _{G(TH)}			17.2		
Gate-to-Source Charge	Q _{GS}			25.8		
Gate-to-Drain Charge	Q _{GD}			17.4		
Gate Resistance	R _G	f = 1 MHz		0.60		Ω

SWITCHING CHARACTERISTICS

Turn-On Delay Time	t _{d(ON)}	Resistive Load, V _{GS} = 0/10 V, V _{DD} = 32 V, I _D = 50 A, R _G = 0 Ω		28		ns
Rise Time	t _r			9		
Turn-Off Delay Time	t _{d(OFF)}			47		
Fall Time	t _f			7.3		

SOURCE TO DRAIN DIODE CHARACTERISTICS

Forward Diode Voltage	V _{SD}	I _S = 30 A, V _{GS} = 0 V, T _J = 25°C		0.78		V
		I _S = 30 A, V _{GS} = 0 V, T _J = 125°C		0.63		
Reverse Recovery Time	t _{RR}	V _{GS} = 0 V, I _S = 50 A, di/dt = 100 A/μs, V _{DD} = 32 V		83		ns
Charge Time	t _a			47		
Discharge Time	t _b			36		
Reverse Recovery Charge	Q _{RR}			246		nC

Product parametric performance is indicated in the Electrical Characteristics for the listed test conditions, unless otherwise noted. Product performance may not be indicated by the Electrical Characteristics if operated under different conditions.

NVMFWS0D63N04XM

TYPICAL CHARACTERISTICS

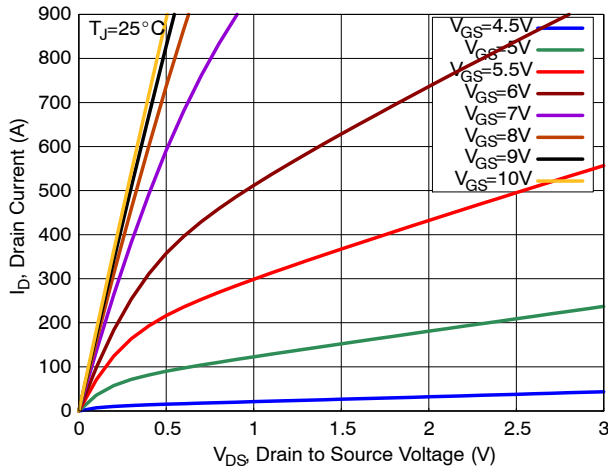

Figure 1. On-Region Characteristics

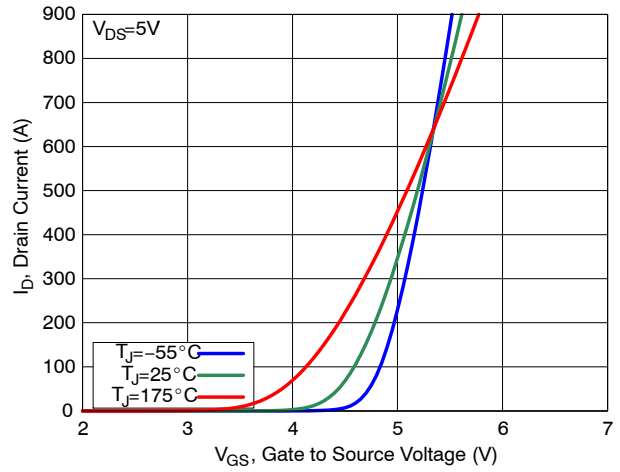

Figure 2. Transfer Characteristics

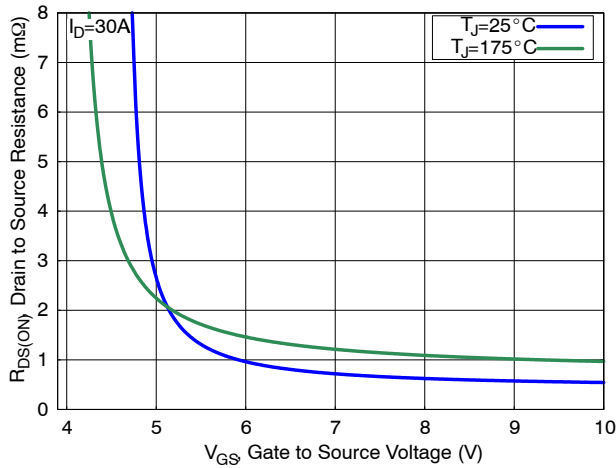

Figure 3. On-Resistance vs. Gate Voltage

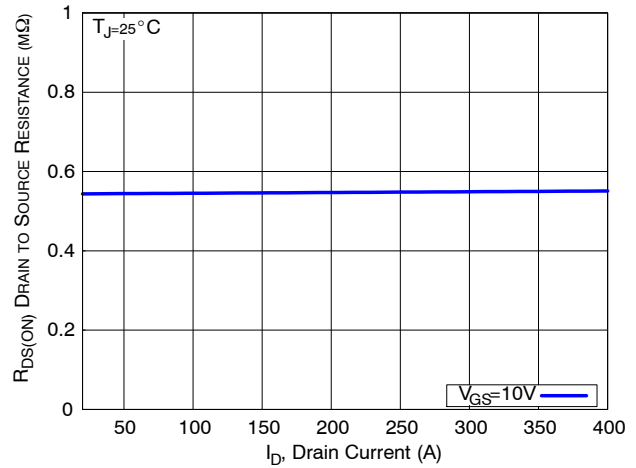

Figure 4. On-Resistance vs. Drain Current

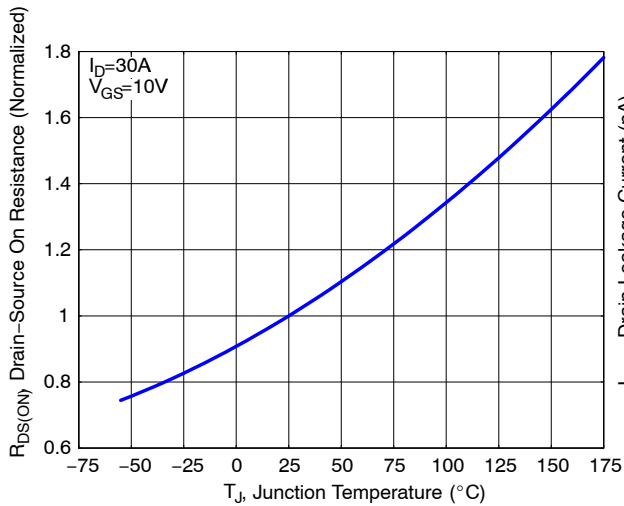

Figure 5. Normalized On-Resistance vs. Junction Temperature

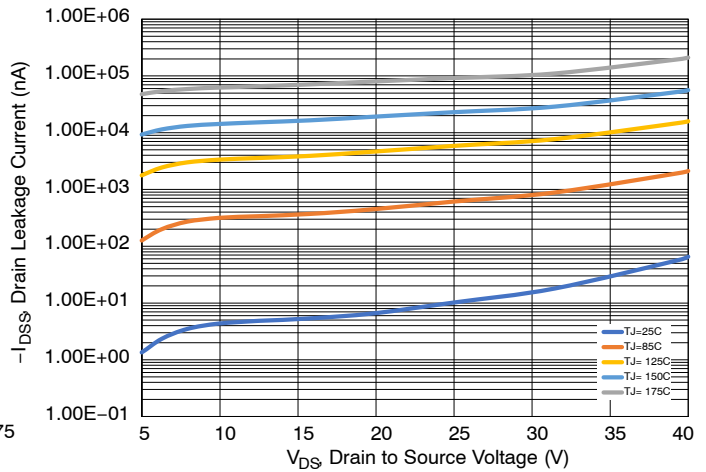

Figure 6. Drain-to-Source Leakage Current vs. Drain Voltage

NVMFWS0D63N04XM

TYPICAL CHARACTERISTICS (continued)

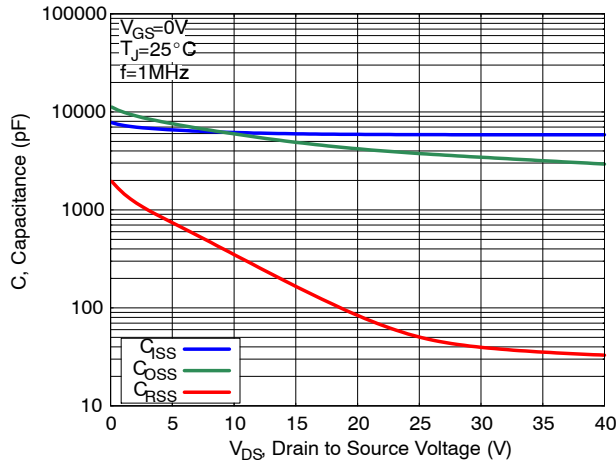

Figure 7. Capacitance Characteristics

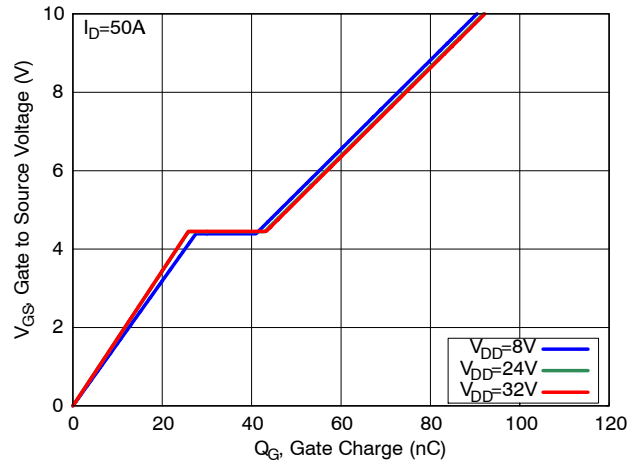

Figure 8. Gate Charge Characteristics

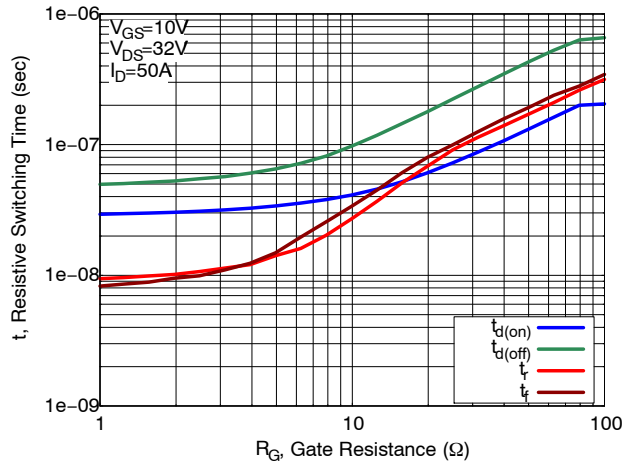

Figure 9. Resistive Switching Time Variation vs. Gate Resistance

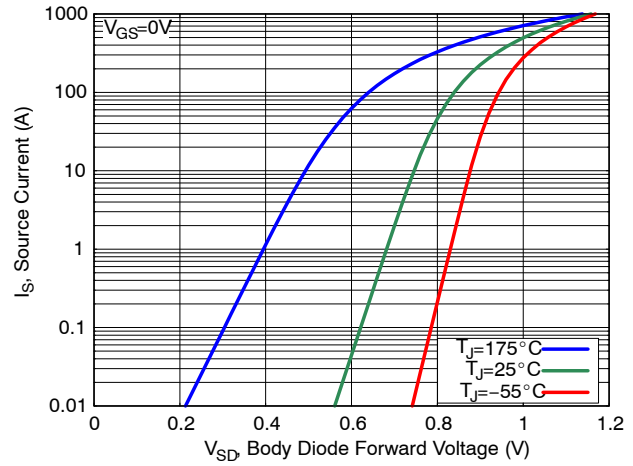

Figure 10. Diode Forward Voltage vs. Current

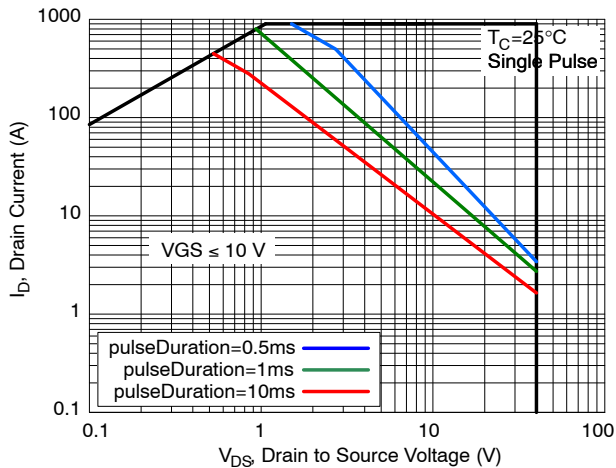

Figure 11. Safe Operating Area (SOA)

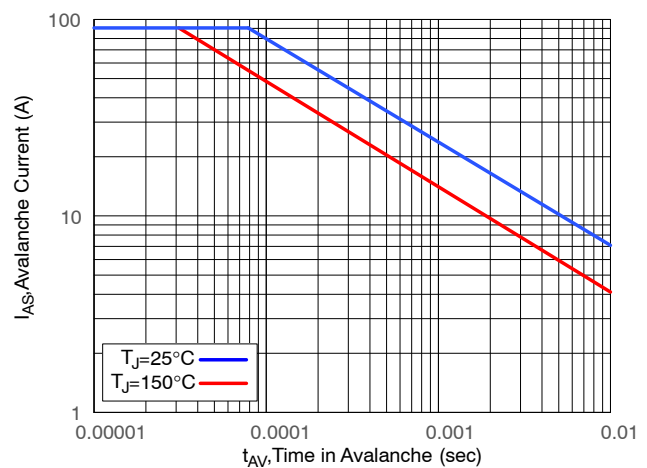

Figure 12. Avalanche Current vs. Pulse Time (UIS)

NVMFWS0D63N04XM

TYPICAL CHARACTERISTICS (continued)

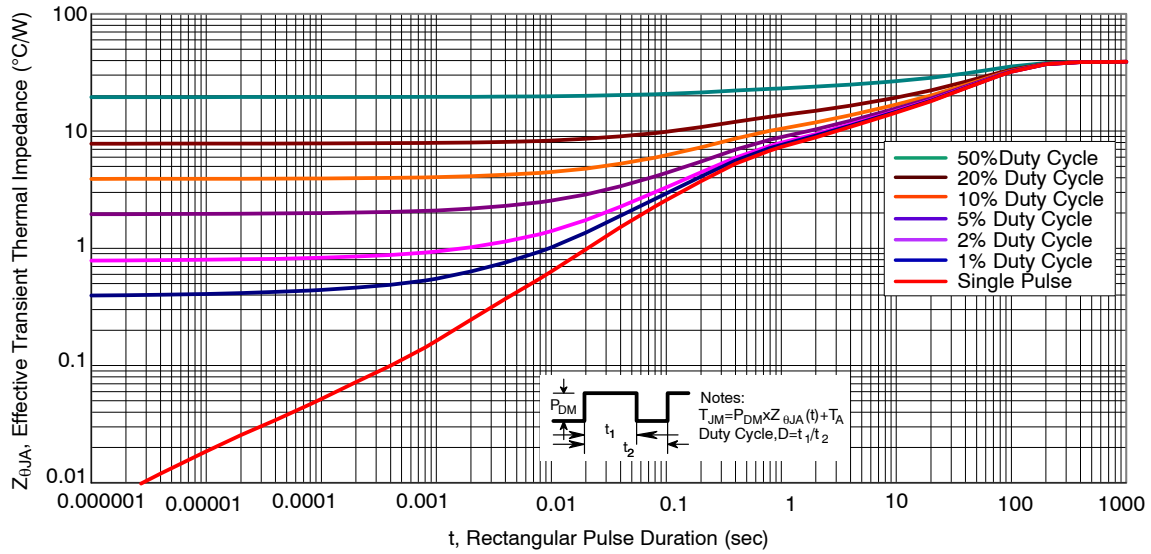

Figure 13. Thermal Characteristics

ORDERING INFORMATION

Device	Marking	Package	Shipping†
NVMFWS0D63N04XMT1G	063N4W	DFNW5 (Pb-Free)	1500 / Tape & Reel

†For information on tape and reel specifications, including part orientation and tape sizes, please refer to our Tape and Reel Packaging Specifications Brochure, BRD8011/D.

NVMFWS0D63N04XM

PACKAGE DIMENSIONS

DFNW5 5x6 (FULL-CUT SO8FL WF)

CASE 507BA

ISSUE A

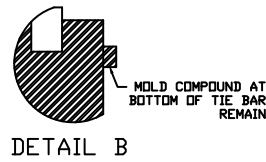
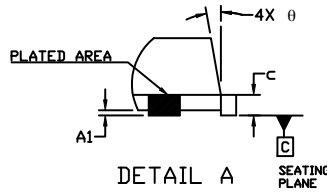
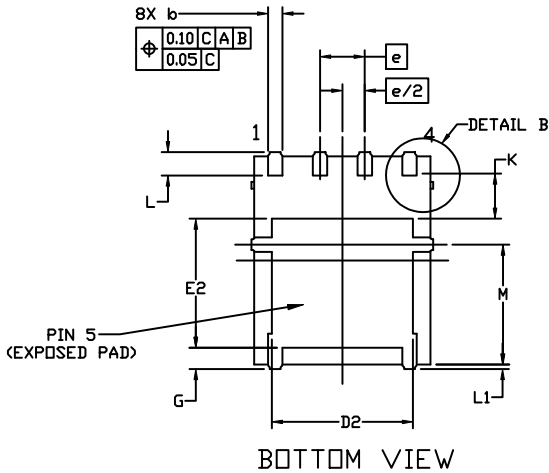
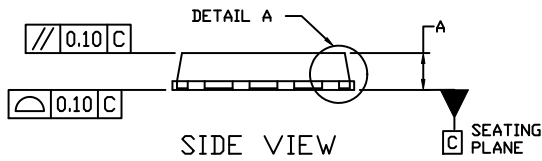
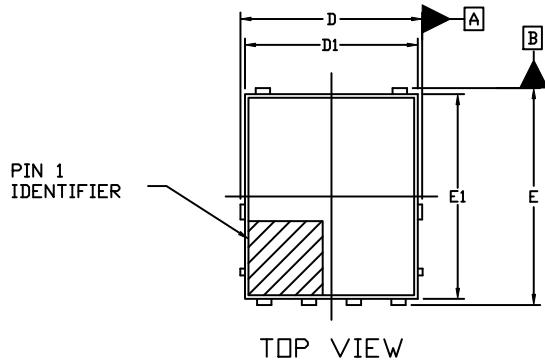

- NOTES:
1. DIMENSIONING AND TOLERANCING PER ASME Y14.5M, 2009.
 2. CONTROLLING DIMENSION: MILLIMETERS
 3. DIMENSIONS D1 AND E1 DO NOT INCLUDE MOLD FLASH, PROTRUSIONS, OR GATE BURRS.
 4. THIS PACKAGE CONTAINS WETTABLE FLANK DESIGN FEATURES TO AID IN FILLET FORMATION ON THE LEADS DURING MOUNTING.

DIM	MILLIMETERS		
	MIN.	NOM.	MAX.
A	0.90	1.00	1.10
A1	0.00	---	0.05
b	0.33	0.41	0.51
c	0.23	0.28	0.33
D	5.00	5.15	5.30
D1	4.70	4.90	5.10
D2	3.80	4.00	4.20
E	6.00	6.15	6.30
E1	5.70	5.90	6.10
E2	3.45	3.65	3.85
e	1.27 BSC		
G	0.51	0.575	0.71
K	1.20	1.35	1.50
L	0.51	0.575	0.71
L1	0.150 REF		
M	3.00	3.40	3.80
θ	0°	---	12°

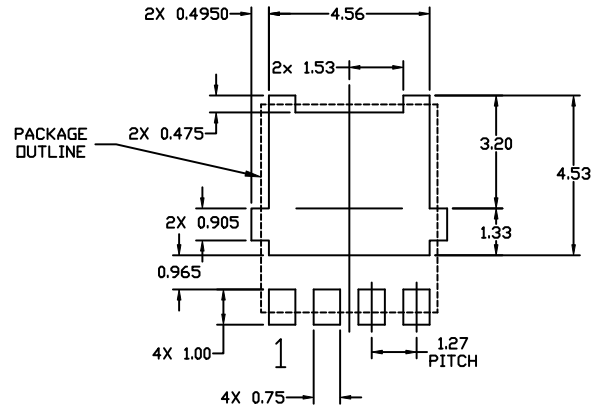

RECOMMENDED MOUNTING FOOTPRINT

- * For additional information on our Pb-Free strategy and soldering details, please download the [DN Semiconductor Soldering and Mounting Techniques Reference Manual, SOLDERRM/D](#).

onsemi, **Onsemi**, and other names, marks, and brands are registered and/or common law trademarks of Semiconductor Components Industries, LLC dba "**onsemi**" or its affiliates and/or subsidiaries in the United States and/or other countries. **onsemi** owns the rights to a number of patents, trademarks, copyrights, trade secrets, and other intellectual property. A listing of **onsemi**'s product/patent coverage may be accessed at www.onsemi.com/site/pdf/Patent-Marking.pdf. **onsemi** reserves the right to make changes at any time to any products or information herein, without notice. The information herein is provided "as-is" and **onsemi** makes no warranty, representation or guarantee regarding the accuracy of the information, product features, availability, functionality, or suitability of its products for any particular purpose, nor does **onsemi** assume any liability arising out of the application or use of any product or circuit, and specifically disclaims any and all liability, including without limitation special, consequential or incidental damages. Buyer is responsible for its products and applications using **onsemi** products, including compliance with all laws, regulations and safety requirements or standards, regardless of any support or applications information provided by **onsemi**. "Typical" parameters which may be provided in **onsemi** data sheets and/or specifications can and do vary in different applications and actual performance may vary over time. All operating parameters, including "Typicals" must be validated for each customer application by customer's technical experts. **onsemi** does not convey any license under any of its intellectual property rights nor the rights of others. **onsemi** products are not designed, intended, or authorized for use as a critical component in life support systems or any FDA Class 3 medical devices or medical devices with a same or similar classification in a foreign jurisdiction or any devices intended for implantation in the human body. Should Buyer purchase or use **onsemi** products for any such unintended or unauthorized application, Buyer shall indemnify and hold **onsemi** and its officers, employees, subsidiaries, affiliates, and distributors harmless against all claims, costs, damages, and expenses, and reasonable attorney fees arising out of, directly or indirectly, any claim of personal injury or death associated with such unintended or unauthorized use, even if such claim alleges that **onsemi** was negligent regarding the design or manufacture of the part. **onsemi** is an Equal Opportunity/Affirmative Action Employer. This literature is subject to all applicable copyright laws and is not for resale in any manner.

ADDITIONAL INFORMATION

TECHNICAL PUBLICATIONS:

Technical Library: www.onsemi.com/design/resources/technical-documentation
onsemi Website: www.onsemi.com

ONLINE SUPPORT: www.onsemi.com/support

For additional information, please contact your local Sales Representative at www.onsemi.com/support/sales