

Silicon Carbide (SiC) Module – EliteSiC, 20 mohm SiC M1 MOSFET, 1200 V, 4-PACK Full Bridge Topology, F1 Package

NXH020F120MNF1PTG, NXH020F120MNF1PG

The NXH020F120MNF1 is a power module containing an 20 mΩ/1200 V SiC MOSFET full bridge and a thermistor in an F1 package.

Features

- 20 mΩ / 1200 V SiC MOSFET Half-Bridge
- Thermistor
- Options with Pre-Applied Thermal Interface Material (TIM) and without Pre-Applied TIM
- Press-Fit Pins
- These Devices are Pb-Free, Halide Free and are RoHS Compliant

Typical Applications

- Solar Inverter
- Uninterruptible Power Supplies
- Electric Vehicle Charging Stations
- Industrial Power

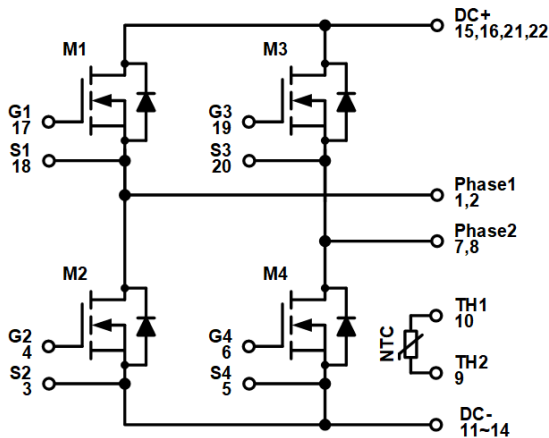
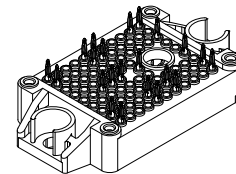

Figure 1. NXH020F120MNF1 Schematic Diagram

PACKAGE PICTURE



PIM22 33.8x42.5 (PRESS FIT)
CASE 180BX

MARKING DIAGRAM

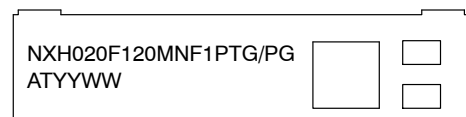

XXXXX = Specific Device Code
AT = Assembly & Test Site Code
YWW = Year and Work Week Code

PIN CONNECTIONS

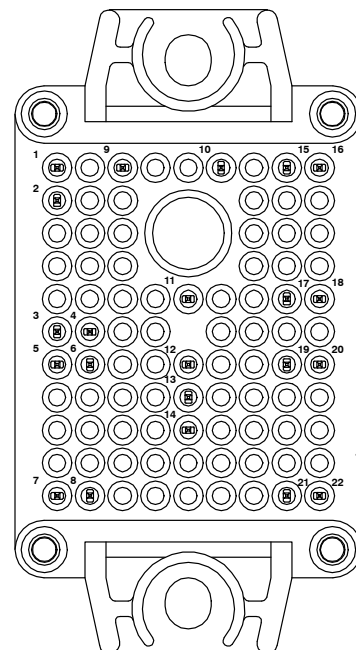

See Pin Function Description for pin names

ORDERING INFORMATION

See detailed ordering and shipping information on page 4 of this data sheet.

NXH020F120MNF1PTG, NXH020F120MNF1PG

PIN FUNCTION DESCRIPTION

Pin	Name	Description
1	Phase 1	Center point of M1 and M2
2	Phase 1	Center point of M1 and M2
3	S2	M2 Kelvin Emitter (High side switch)
4	G2	M2 Gate (High side switch)
5	S4	M4 Kelvin Emitter (High side switch)
6	G4	M4 Gate (High side switch)
7	AC2	Center point of M3 and M4
8	AC2	Center point of M3 and M4
9	TH2	Thermistor Connection 2
10	TH1	Thermistor Connection 1
11	DC-	DC Negative Bus connection
12	DC-	DC Negative Bus connection
13	DC-	DC Negative Bus connection
14	DC-	DC Negative Bus connection
15	DC+	DC Positive Bus connection
16	DC+	DC Positive Bus connection
17	G1	M1 Gate (High side switch)
18	S1	M1 Kelvin Emitter (High side switch)
19	G3	M3 Gate (Low side switch)
20	S3	M3 Kelvin Emitter (High side switch)
21	DC+	DC Positive Bus connection
22	DC+	DC Positive Bus connection

MAXIMUM RATINGS

Rating	Symbol	Value	Unit
SiC MOSFET			
Drain-Source Voltage	V_{DSS}	1200	V
Gate-Source Voltage	V_{GS}	+25/-15	V
Continuous Drain Current @ $T_C = 80^\circ\text{C}$ ($T_J = 175^\circ\text{C}$)	I_D	51	A
Pulsed Drain Current ($T_J = 175^\circ\text{C}$)	I_{Dpulse}	102	A
Maximum Power Dissipation @ $T_C = 80^\circ\text{C}$ ($T_J = 175^\circ\text{C}$)	P_{tot}	211	W
Minimum Operating Junction Temperature	T_{JMIN}	-40	$^\circ\text{C}$
Maximum Operating Junction Temperature	T_{JMAX}	175	$^\circ\text{C}$

THERMAL PROPERTIES

Storage Temperature Range	T_{stg}	-40 to 150	$^\circ\text{C}$
---------------------------	-----------	------------	------------------

INSULATION PROPERTIES

Isolation Test Voltage, $t = 1$ s, 60 Hz	V_{is}	4800	V_{RMS}
Creepage Distance		12.7	mm

Stresses exceeding those listed in the Maximum Ratings table may damage the device. If any of these limits are exceeded, device functionality should not be assumed, damage may occur and reliability may be affected.

1. Refer to ELECTRICAL CHARACTERISTICS, RECOMMENDED OPERATING RANGES and/or APPLICATION INFORMATION for Safe Operating parameters.

NXH020F120MNF1PTG, NXH020F120MNF1PG

RECOMMENDED OPERATING RANGES

Rating	Symbol	Min	Max	Unit
Module Operating Junction Temperature	T_J	-40	175	°C

Functional operation above the stresses listed in the Recommended Operating Ranges is not implied. Extended exposure to stresses beyond the Recommended Operating Ranges limits may affect device reliability.

ELECTRICAL CHARACTERISTICS

$T_J = 25\text{ °C}$ unless otherwise noted

Parameter	Test Conditions	Symbol	Min	Typ	Max	Unit
-----------	-----------------	--------	-----	-----	-----	------

SiC MOSFET CHARACTERISTICS

Drain-Source Breakdown Voltage	$V_{GS} = 0\text{ V}, I_D = 400\text{ }\mu\text{A}$	$V_{(BR)DSS}$	1200	–	–	V	
Zero Gate Voltage Drain Current	$V_{GS} = 0\text{ V}, V_{DS} = 1200\text{ V}$	I_{DSS}	–	–	200	μA	
Drain-Source On Resistance	$V_{GS} = 20\text{ V}, I_D = 50\text{ A}, T_J = 25\text{ °C}$	$R_{DS(ON)}$	–	20	30	$\text{m}\Omega$	
	$V_{GS} = 20\text{ V}, I_D = 50\text{ A}, T_J = 125\text{ °C}$		–	28	–		
	$V_{GS} = 20\text{ V}, I_D = 50\text{ A}, T_J = 150\text{ °C}$		–	31	–		
Gate-Source Threshold Voltage	$V_{GS} = V_{DS}, I_D = 20\text{ mA}$	$V_{GS(TH)}$	1.8	2.81	4.3	V	
Gate Leakage Current	$V_{GS} = -10\text{ V}/20\text{ V}, V_{DS} = 0\text{ V}$	I_{GSS}	-500	–	500	nA	
Input Capacitance	$V_{DS} = 800\text{ V}, V_{GS} = 0\text{ V}, f = 1\text{ MHz}$	C_{ISS}	–	2420	–	pF	
Reverse Transfer Capacitance		C_{RSS}	–	19	–		
Output Capacitance		C_{OSS}	–	293	–		
Total Gate Charge	$V_{DS} = 800\text{ V}, V_{GS} = 20\text{ V}, I_D = 50\text{ A}$	$Q_{G(TOTAL)}$	–	213.5	–	nC	
Gate-Source Charge		Q_{GS}	–	60.0	–		
Gate-Drain Charge		Q_{GD}	–	61.2	–		
Turn-on Delay Time	$T_J = 25\text{ °C},$ $V_{DS} = 600\text{ V}, I_D = 50\text{ A},$ $V_{GS} = -5\text{ V}/18\text{ V}, R_G = 2.2\text{ }\Omega$	$t_{d(on)}$	–	30.6	–	ns	
Rise Time		t_r	–	8.7	–		
Turn-off Delay Time		$t_{d(off)}$	–	70.2	–		
Fall Time		t_f	–	3.8	–		
Turn-on Switching Loss per Pulse		E_{ON}	–	0.26	–		mJ
Turn off Switching Loss per Pulse		E_{OFF}	–	0.21	–		
Turn-on Delay Time	$T_J = 150\text{ °C},$ $V_{DS} = 600\text{ V}, I_D = 50\text{ A},$ $V_{GS} = -5\text{ V}/18\text{ V}, R_G = 2.2\text{ }\Omega$	$t_{d(on)}$	–	29.7	–	ns	
Rise Time		t_r	–	8.1	–		
Turn-off Delay Time		$t_{d(off)}$	–	78.4	–		
Fall Time		t_f	–	6.4	–		
Turn-on Switching Loss per Pulse		E_{ON}	–	0.24	–		mJ
Turn off Switching Loss per Pulse		E_{OFF}	–	0.24	–		
Diode Forward Voltage	$I_D = 50\text{ A}$	V_{SD}	–	3.93	6	V	
	$I_D = 50\text{ A}, T_J = 125\text{ °C}$		–	3.47	–		
	$I_D = 50\text{ A}, T_J = 150\text{ °C}$		–	3.39	–		
Reverse Recovery Time	$T_J = 25\text{ °C},$ $V_{DS} = 600\text{ V}, I_D = 50\text{ A},$ $V_{GS} = -5\text{ V}/18\text{ V}, R_G = 2.2\text{ }\Omega$	t_{rr}	–	23.5	–	ns	
Reverse Recovery Charge		Q_{rr}	–	1069	–		
Peak Reverse Recovery Current		I_{RRM}	–	70	–		
Peak Rate of Fall of Recovery Current		di/dt	–	6897	–		
Reverse Recovery Energy		E_{rr}	–	592	–		
							μJ

NXH020F120MNF1PTG, NXH020F120MNF1PG

ELECTRICAL CHARACTERISTICS (continued)

T_J = 25 °C unless otherwise noted

Parameter	Test Conditions	Symbol	Min	Typ	Max	Unit
SiC MOSFET CHARACTERISTICS						
Reverse Recovery Time	T _J = 150°C, V _{DS} = 600 V, I _D = 50 A, V _{GS} = -5 V/18 V, R _G = 2.2 Ω	t _{rr}	–	28.0	–	ns
Reverse Recovery Charge		Q _{rr}	–	2000	–	μC
Peak Reverse Recovery Current		I _{RRM}	–	117	–	A
Peak Rate of Fall of Recovery Current		di/dt	–	9137	–	A/μs
Reverse Recovery Energy		E _{rr}	–	1163	–	μJ
Thermal Resistance – Chip-to-Case	M1, M2, M3, M4	R _{thJC}	–	0.4495	–	°C/W
Thermal Resistance – Chip-to-Heatsink	Thermal grease, Thickness = 2 Mil ±2%, A = 2.8 W/mK	R _{thJH}	–	0.7971	–	°C/W

THERMISTOR CHARACTERISTICS

Nominal Resistance	T _{NTC} = 25°C	R ₂₅	–	5	–	kΩ
Nominal Resistance	T _{NTC} = 100°C	R ₁₀₀	–	493	–	Ω
Nominal Resistance	T _{NTC} = 150°C	R ₁₅₀	–	159.5	–	Ω
Deviation of R ₁₀₀	T _{NTC} = 100°C	ΔR/R	-5	–	5	%
Power Dissipation – Recommended Limit	0.15 mA, non-self-heating effect	P _D	–	0.1	–	mW
Power Dissipation Constant – Absolute Maximum	5 mA	P _D	–	34.2	–	mW
Power Dissipation Constant		–	–	1.4	–	mW/K
B-value	B(25/50), tolerance ±2%	–	–	3375	–	K
B-value	B(25/100), tolerance ±2%	–	–	3436	–	K

Product parametric performance is indicated in the Electrical Characteristics for the listed test conditions, unless otherwise noted. Product performance may not be indicated by the Electrical Characteristics if operated under different conditions.

ORDERING INFORMATION

Orderable Part Number	Marking	Package	Shipping
NXH020F120MNF1PTG	NXH020F120MNF1PTG	F1-4PACK Press-fit Pins with pre-applied thermal interface material (TIM) (Pb-Free and Halide-Free)	28 Units / Blister Tray
NXH020F120MNF1PG	NXH020F120MNF1PG	F1-4PACK Press-fit Pins (Pb-Free and Halide-Free)	28 Units / Blister Tray

NXH020F120MNF1PTG, NXH020F120MNF1PG

TYPICAL CHARACTERISTICS (25°C UNLESS OTHERWISE NOTED)

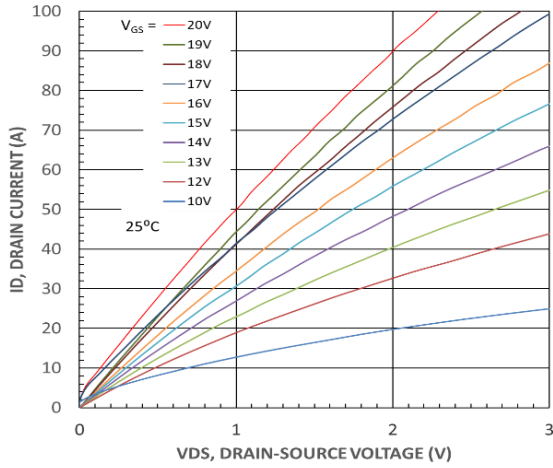

Figure 2. MOSFET Typical Output Characteristics

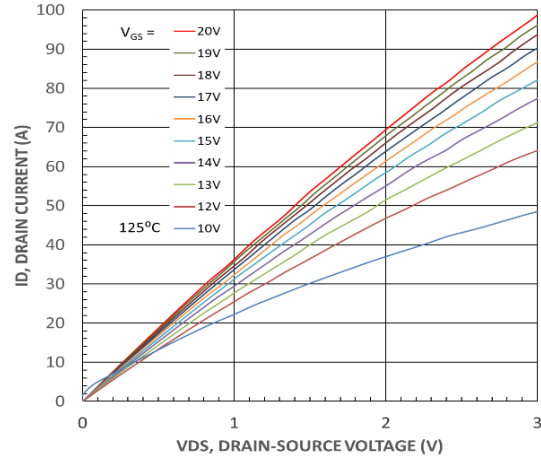

Figure 3. MOSFET Typical Output Characteristics

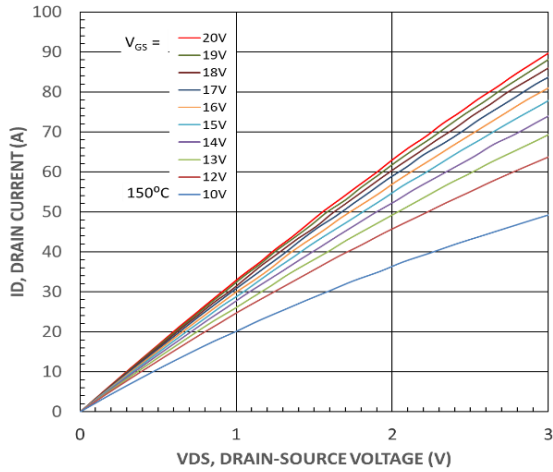

Figure 4. MOSFET Typical Output Characteristics

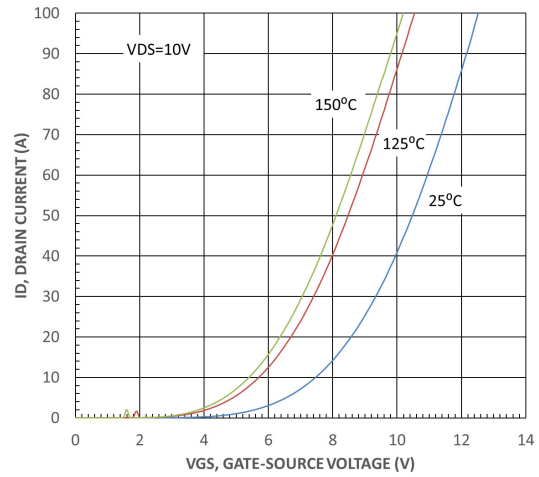

Figure 5. MOSFET Typical Transfer Characteristics

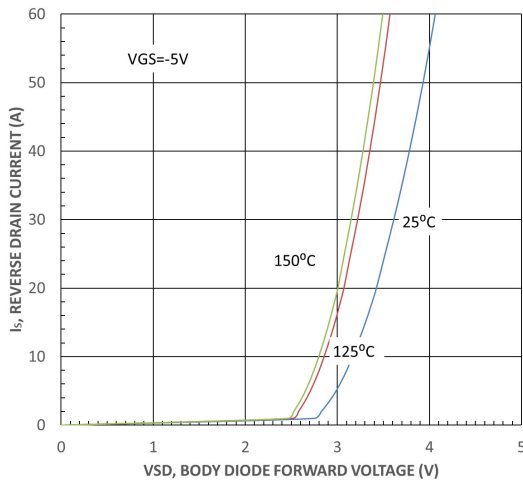

Figure 6. Body Diode Forward Characteristic

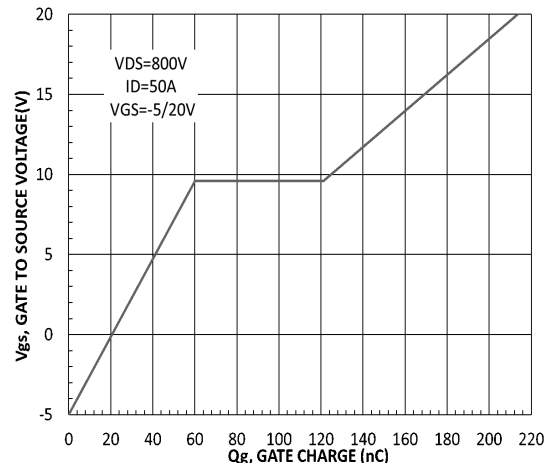

Figure 7. Gate-to-Source Voltage vs. Total Charge

NXH020F120MNF1PTG, NXH020F120MNF1PG

TYPICAL CHARACTERISTICS (CONTINUED)

(25°C UNLESS OTHERWISE NOTED)

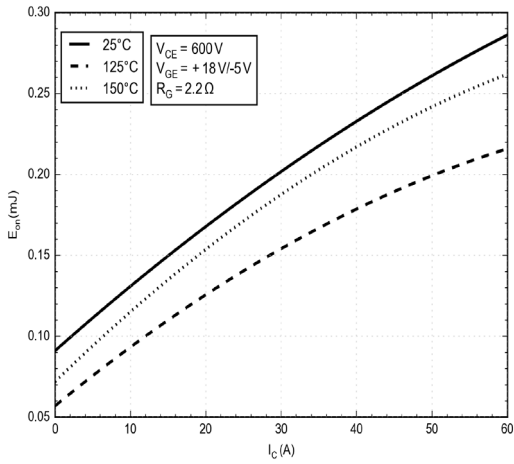

Figure 8. Typical Switching Loss E_{ON} vs. I_C

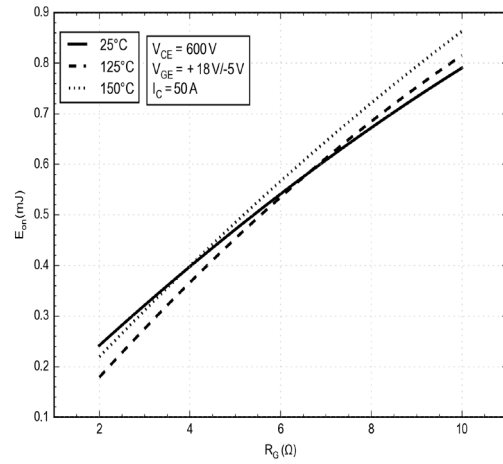

Figure 9. Typical Switching Loss E_{ON} vs. R_G

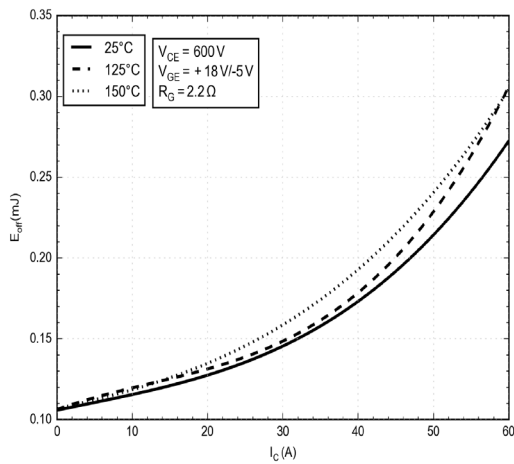

Figure 10. Typical Switching Loss E_{OFF} vs. I_C

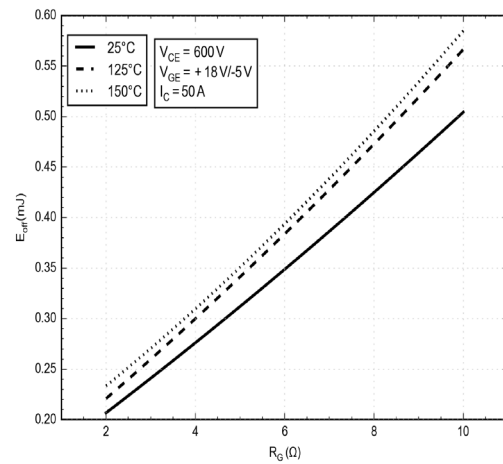

Figure 11. Typical Switching Loss E_{OFF} vs. R_G

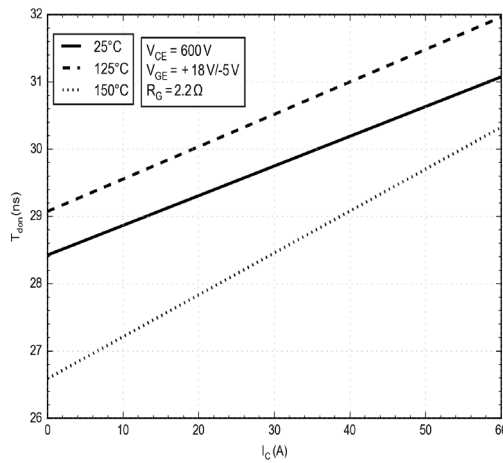

Figure 12. Typical Turn-On Switching T_{don} vs. I_C

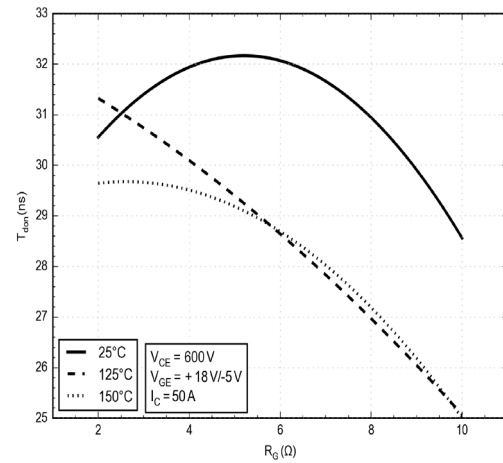

Figure 13. Typical Turn-On Switching T_{don} vs. R_G

NXH020F120MNF1PTG, NXH020F120MNF1PG

TYPICAL CHARACTERISTICS (CONTINUED)

(25°C UNLESS OTHERWISE NOTED)

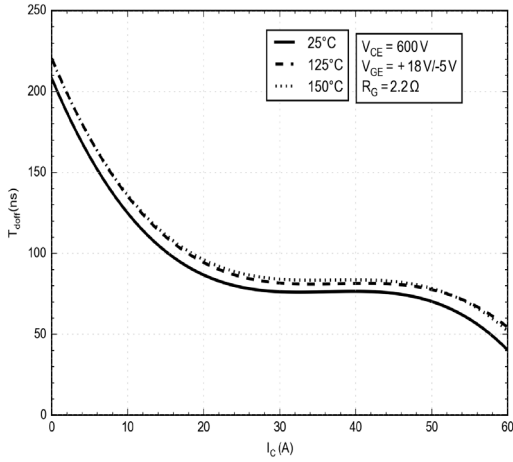

Figure 14. Typical Turn-Off Switching T_{doff} vs. I_c

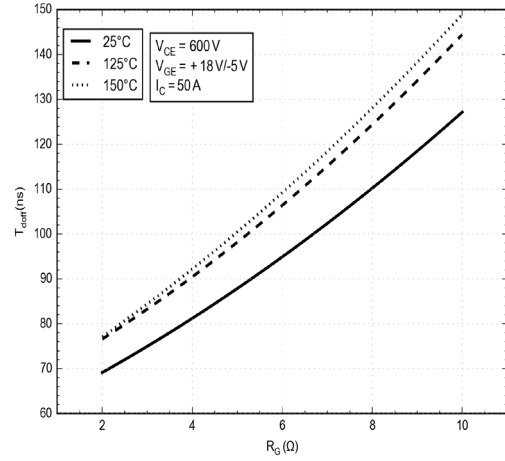

Figure 15. Typical Turn-Off Switching T_{doff} vs. R_G

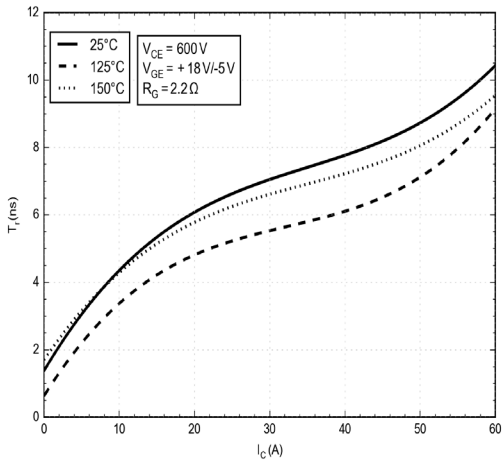

Figure 16. Typical Turn-On Switching T_r vs. I_c

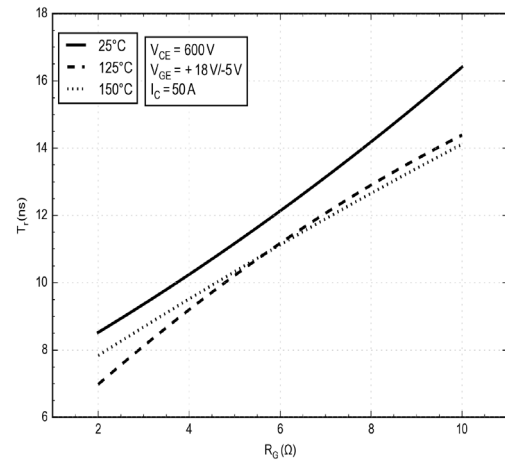

Figure 17. Typical Turn-On Switching T_r vs. R_G

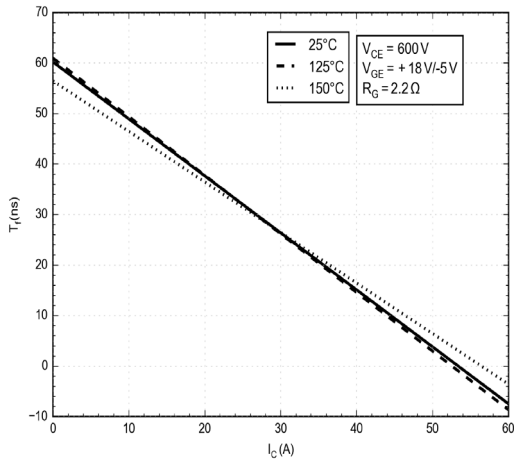

Figure 18. Typical Turn-Off Switching T_f vs. I_c

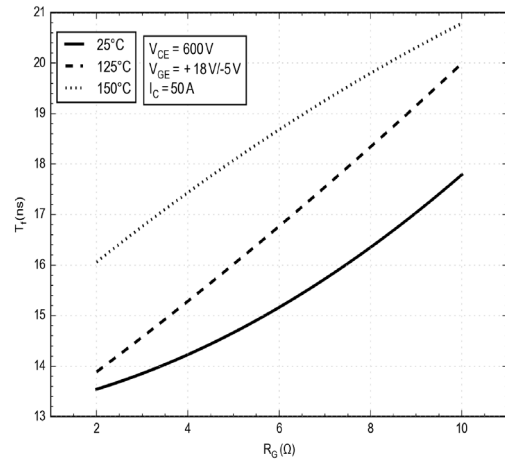

Figure 19. Typical Turn-Off Switching T_f vs. R_G

NXH020F120MNF1PTG, NXH020F120MNF1PG

TYPICAL CHARACTERISTICS (CONTINUED) (25°C UNLESS OTHERWISE NOTED)

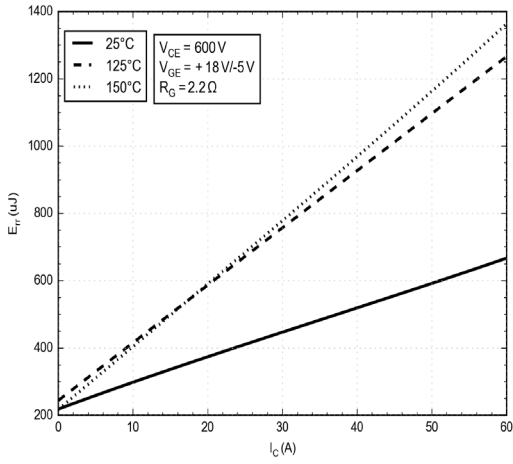

Figure 20. Typical Reverse Recovery Energy vs. I_C

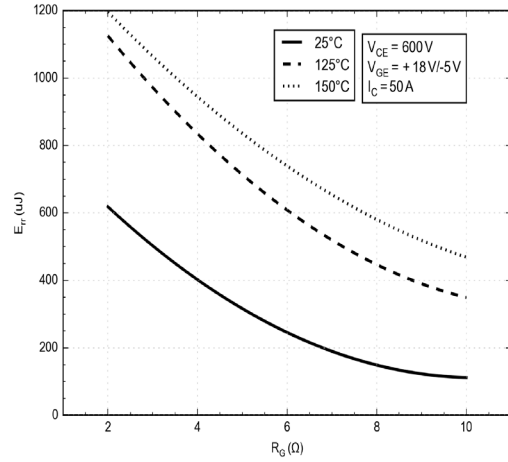

Figure 21. Typical Reverse Recovery Energy vs. R_G

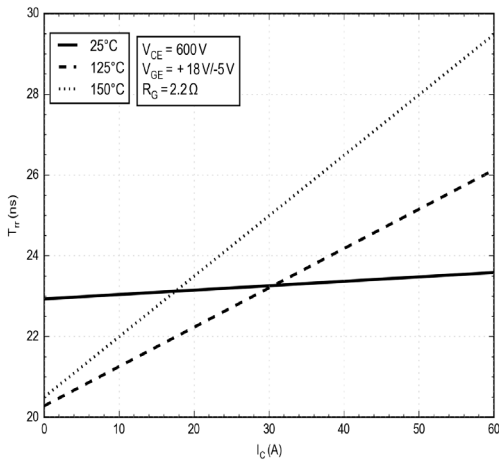

Figure 22. Typical Reverse Recovery Time vs. I_C

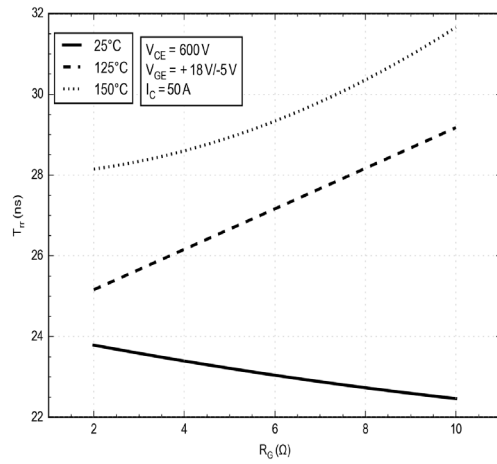

Figure 23. Typical Reverse Recovery Time vs. R_G

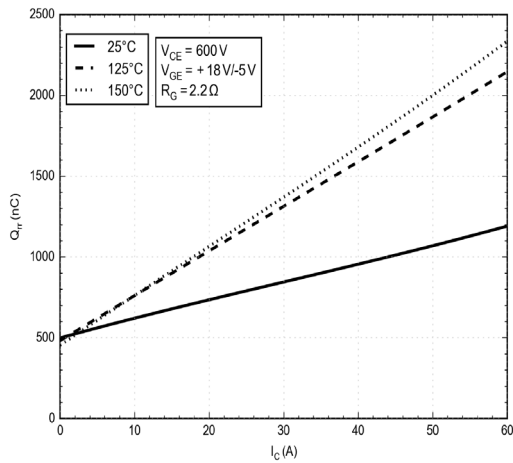

Figure 24. Typical Reverse Recovery Charge vs. I_C

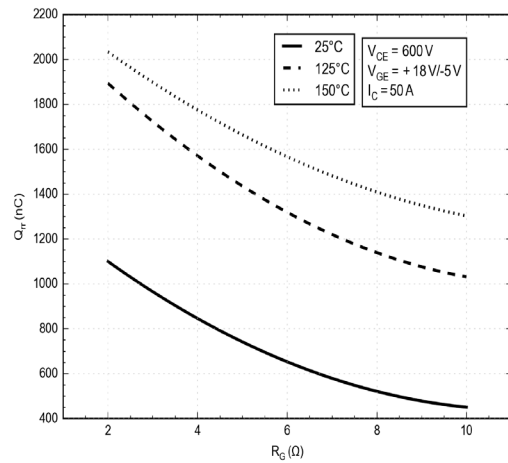

Figure 25. Typical Reverse Recovery Charge vs. R_G

NXH020F120MNF1PTG, NXH020F120MNF1PG

TYPICAL CHARACTERISTICS (CONTINUED) (25°C UNLESS OTHERWISE NOTED)

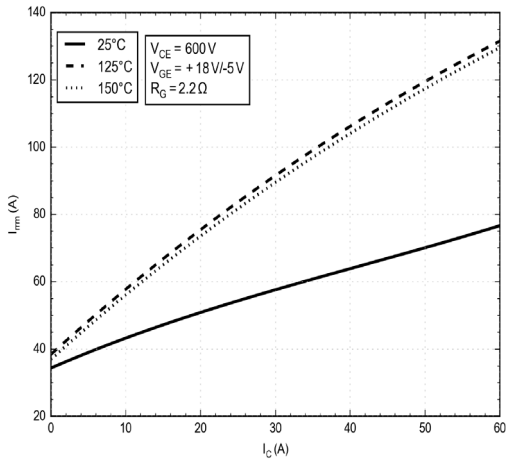

Figure 26. Typical Reverse Recovery Current vs. I_C

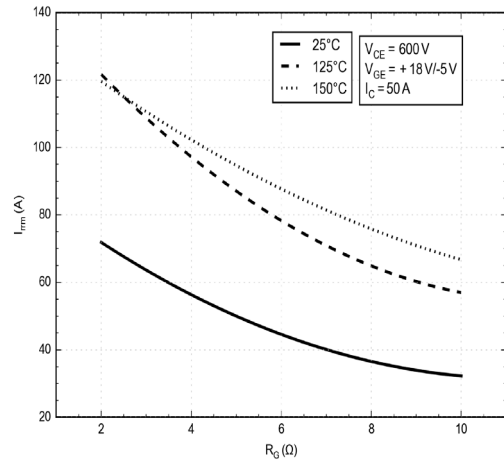

Figure 27. Typical Reverse Recovery Current vs. R_G

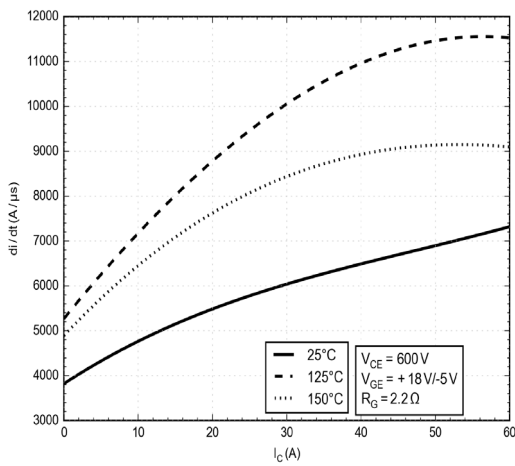

Figure 28. Typical di/dt vs. I_C

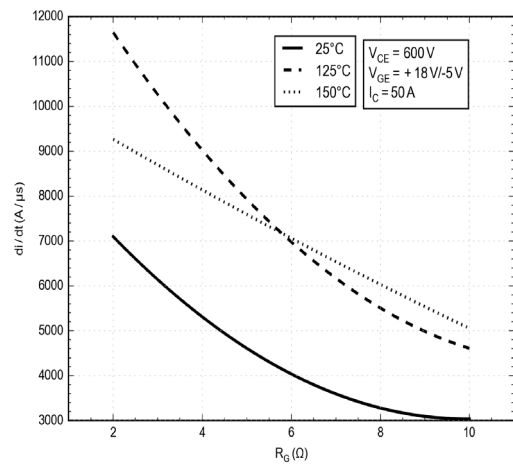

Figure 29. Typical di/dt vs. R_G

NXH020F120MNF1PTG, NXH020F120MNF1PG

TYPICAL CHARACTERISTICS (CONTINUED) (25°C UNLESS OTHERWISE NOTED)

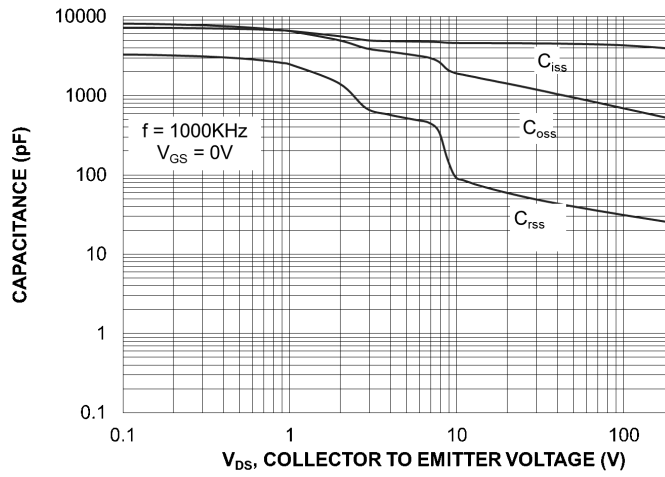

Figure 30. Capacitance vs. Drain-to-Source Voltage

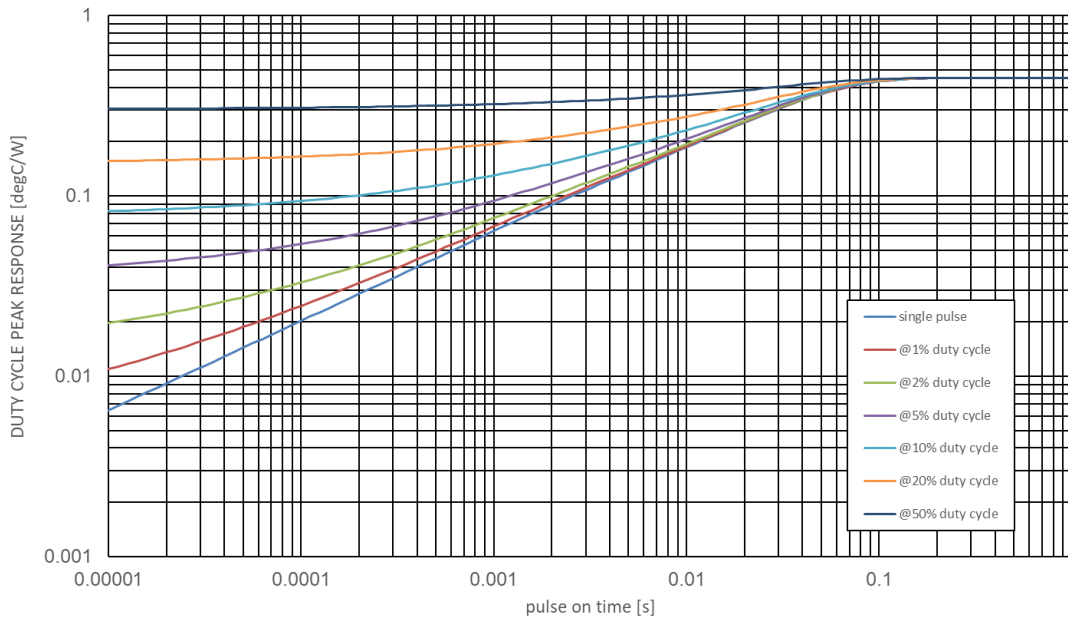

Figure 31. MOSFET Junction-to-Case Transient Thermal Impedance

NXH020F120MNF1PTG, NXH020F120MNF1PG

Table 1. FOSTER NETWORKS – M1, M2, M3, M4

Foster Element #	M1, M3		M2, M4	
	Rth (K/W)	Cth (Ws/K)	Rth (K/W)	Cth (Ws/K)
1	0.017325	0.008638	0.026614	0.005297
2	0.022329	0.043836	0.014274	0.064284
3	0.016565	0.107000	0.006208	0.315671
4	0.041616	0.125888	0.075096	0.078283
5	0.338223	0.099402	0.338851	0.124492

Table 2. CAUER NETWORKS – M1, M2, M3, M4

Cauer Element #	M1, M3		M2, M4	
	Rth (K/W)	Cth (Ws/K)	Rth (K/W)	Cth (Ws/K)
1	0.034247	0.006027	0.038327	0.004380
2	0.073342	0.018048	0.072292	0.025045
3	0.106345	0.041141	0.118744	0.030910
4	0.100786	0.040901	0.069379	0.066961
5	0.121340	0.076490	0.162299	0.074739

onsemi, **Onsemi**, and other names, marks, and brands are registered and/or common law trademarks of Semiconductor Components Industries, LLC dba "**onsemi**" or its affiliates and/or subsidiaries in the United States and/or other countries. **onsemi** owns the rights to a number of patents, trademarks, copyrights, trade secrets, and other intellectual property. A listing of **onsemi**'s product/patent coverage may be accessed at www.onsemi.com/site/pdf/Patent-Marking.pdf. **onsemi** reserves the right to make changes at any time to any products or information herein, without notice. The information herein is provided "as-is" and **onsemi** makes no warranty, representation or guarantee regarding the accuracy of the information, product features, availability, functionality, or suitability of its products for any particular purpose, nor does **onsemi** assume any liability arising out of the application or use of any product or circuit, and specifically disclaims any and all liability, including without limitation special, consequential or incidental damages. Buyer is responsible for its products and applications using **onsemi** products, including compliance with all laws, regulations and safety requirements or standards, regardless of any support or applications information provided by **onsemi**. "Typical" parameters which may be provided in **onsemi** data sheets and/or specifications can and do vary in different applications and actual performance may vary over time. All operating parameters, including "Typicals" must be validated for each customer application by customer's technical experts. **onsemi** does not convey any license under any of its intellectual property rights nor the rights of others. **onsemi** products are not designed, intended, or authorized for use as a critical component in life support systems or any FDA Class 3 medical devices or medical devices with a same or similar classification in a foreign jurisdiction or any devices intended for implantation in the human body. Should Buyer purchase or use **onsemi** products for any such unintended or unauthorized application, Buyer shall indemnify and hold **onsemi** and its officers, employees, subsidiaries, affiliates, and distributors harmless against all claims, costs, damages, and expenses, and reasonable attorney fees arising out of, directly or indirectly, any claim of personal injury or death associated with such unintended or unauthorized use, even if such claim alleges that **onsemi** was negligent regarding the design or manufacture of the part. **onsemi** is an Equal Opportunity/Affirmative Action Employer. This literature is subject to all applicable copyright laws and is not for resale in any manner.

ADDITIONAL INFORMATION

TECHNICAL PUBLICATIONS:

Technical Library: www.onsemi.com/design/resources/technical-documentation
onsemi Website: www.onsemi.com

ONLINE SUPPORT: www.onsemi.com/support

For additional information, please contact your local Sales Representative at www.onsemi.com/support/sales