

# Q0PACK Module

## Product Preview

### NXH80T120L3Q0S3G/S3TG, NXH80T120L3Q0P3G

The NXH80T120L3Q0S3/P3G is a power module containing a T-type neutral point clamped (NPC) three level inverter stage. The integrated field stop trench IGBTs and fast recovery diodes provide lower conduction losses and switching losses, enabling designers to achieve high efficiency and superior reliability.

#### Features

- Low Switching Loss
- Low  $V_{CESAT}$
- Compact 65.9 mm x 32.5 mm x 12 mm Package
- Options with Pre-applied Thermal Interface Material (TIM) and Without Pre-applied TIM
- Options with Solderable Pins and Press-fit Pins
- Thermistor

#### Typical Applications

- Solar Inverter
- Uninterruptable Power Supplies

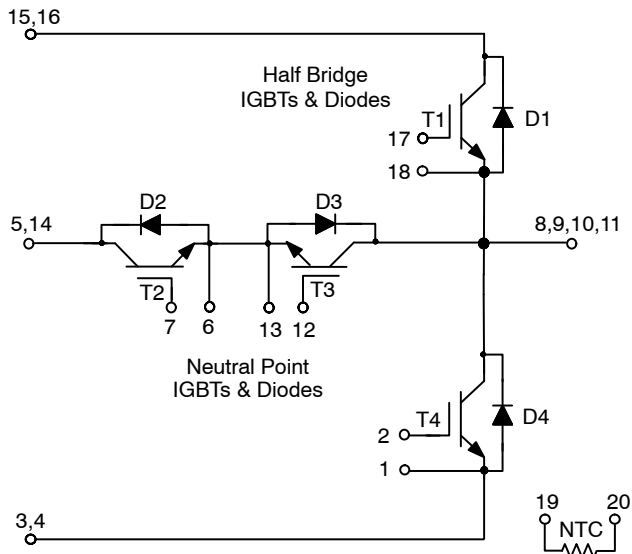

Figure 1. Schematic Diagram

This document contains information on a product under development. ON Semiconductor reserves the right to change or discontinue this product without notice.



ON Semiconductor®

[www.onsemi.com](http://www.onsemi.com)

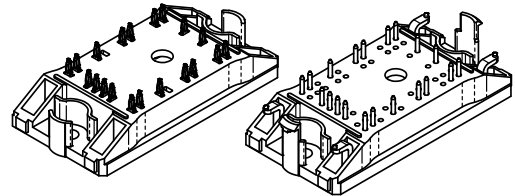

Q0PACK  
CASE 180AA  
PRESS-FIT PINS

Q0PACK  
CASE 180AB  
SOLDERABLE PINS

#### MARKING DIAGRAMS

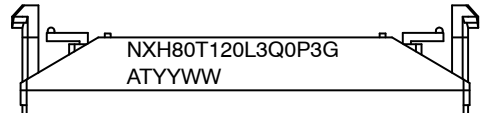
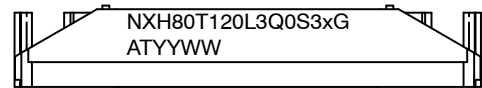

NXH80T120L3Q0S3G = Specific Device Code  
S3xG = S3G or S3TG  
G = Pb-free Package  
A = Assembly Site Code  
T = Test Site Code  
YYWW = Year and Work Week Code

#### PIN ASSIGNMENTS

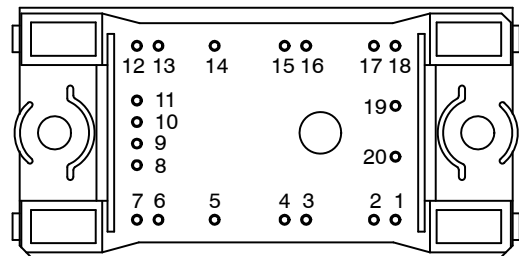

#### ORDERING INFORMATION

See detailed ordering and shipping information in the dimensions section on page 16 of this data sheet.

# NXH80T120L3Q0S3G/S3TG, NXH80T120L3Q0P3G

**Table 1. MAXIMUM RATINGS**

Rating	Symbol	Value	Unit
<b>HALF BRIDGE IGBT</b>			
Collector–Emitter Voltage	$V_{CES}$	1200	V
Gate–Emitter Voltage	$V_{GE}$	$\pm 20$	V
Continuous Collector Current @ $T_c = 80^\circ\text{C}$ ( $T_J = 175^\circ\text{C}$ )	$I_C$	75	A
Pulsed Collector Current ( $T_J = 175^\circ\text{C}$ )	$I_{Cpulse}$	225	A
Maximum Power Dissipation ( $T_J = 175^\circ\text{C}$ )	$P_{tot}$	188	W
Minimum Operating Junction Temperature	$T_{JMIN}$	-40	$^\circ\text{C}$
Maximum Operating Junction Temperature	$T_{JMAX}$	175	$^\circ\text{C}$
<b>NEUTRAL POINT IGBT</b>			
Collector–Emitter Voltage	$V_{CES}$	650	V
Gate–Emitter Voltage	$V_{GE}$	$\pm 20$	V
Continuous Collector Current @ $T_c = 80^\circ\text{C}$ ( $T_J = 175^\circ\text{C}$ )	$I_C$	50	A
Pulsed Collector Current ( $T_J = 175^\circ\text{C}$ )	$I_{Cpulse}$	150	A
Maximum Power Dissipation ( $T_J = 175^\circ\text{C}$ )	$P_{tot}$	82	W
Minimum Operating Junction Temperature	$T_{JMIN}$	-40	$^\circ\text{C}$
Maximum Operating Junction Temperature	$T_{JMAX}$	150	$^\circ\text{C}$
<b>HALF BRIDGE DIODE</b>			
Peak Repetitive Reverse Voltage	$V_{RRM}$	1200	V
Continuous Forward Current @ $T_c = 80^\circ\text{C}$ ( $T_J = 175^\circ\text{C}$ )	$I_F$	37	A
Repetitive Peak Forward Current ( $T_J = 175^\circ\text{C}$ )	$I_{FRM}$	111	A
Maximum Power Dissipation ( $T_J = 175^\circ\text{C}$ )	$P_{tot}$	79	W
Minimum Operating Junction Temperature	$T_{JMIN}$	-40	$^\circ\text{C}$
Maximum Operating Junction Temperature	$T_{JMAX}$	175	$^\circ\text{C}$
<b>NEUTRAL POINT DIODE</b>			
Peak Repetitive Reverse Voltage	$V_{RRM}$	650	V
Continuous Forward Current @ $T_c = 80^\circ\text{C}$ ( $T_J = 175^\circ\text{C}$ )	$I_F$	37	A
Repetitive Peak Forward Current ( $T_J = 175^\circ\text{C}$ )	$I_{FRM}$	111	A
Maximum Power Dissipation ( $T_J = 175^\circ\text{C}$ )	$P_{tot}$	68	W
Minimum Operating Junction Temperature	$T_{JMIN}$	-40	$^\circ\text{C}$
Maximum Operating Junction Temperature	$T_{JMAX}$	150	$^\circ\text{C}$
<b>THERMAL PROPERTIES</b>			
Maximum Operating Junction Temperature under Switching Conditions	$T_{VJOP}$	150	$^\circ\text{C}$
Storage Temperature Range	$T_{stg}$	-40 to 125	$^\circ\text{C}$
Storage Temperature Range (TIM)	$T_{stg}$	-25 to 40	$^\circ\text{C}$
<b>INSULATION PROPERTIES</b>			
Isolation test voltage, $t = 1$ sec, 50 Hz	$V_{is}$	4000	$V_{RMS}$
Creepage distance		12.7	mm

Stresses exceeding those listed in the Maximum Ratings table may damage the device. If any of these limits are exceeded, device functionality should not be assumed, damage may occur and reliability may be affected.

1. Refer to ELECTRICAL CHARACTERISTICS, RECOMMENDED OPERATING RANGES and/or APPLICATION INFORMATION for Safe Operating parameters.

# NXH80T120L3Q0S3G/S3TG, NXH80T120L3Q0P3G

**Table 2. ELECTRICAL CHARACTERISTICS**  $T_J = 25^\circ\text{C}$  unless otherwise noted

Parameter	Test Conditions	Symbol	Min	Typ	Max	Unit
<b>HALF BRIDGE IGBT CHARACTERISTICS</b>						
Collector–Emitter Cutoff Current	$V_{GE} = 0\text{ V}, V_{CE} = 1200\text{ V}$	$I_{CES}$	–	–	300	$\mu\text{A}$
Collector–Emitter Saturation Voltage	$V_{GE} = 15\text{ V}, I_C = 80\text{ A}, T_J = 25^\circ\text{C}$	$V_{CE(sat)}$	–	1.7	2.4	V
	$V_{GE} = 15\text{ V}, I_C = 80\text{ A}, T_J = 150^\circ\text{C}$		–	1.8	–	
Gate–Emitter Threshold Voltage	$V_{GE} = V_{CE}, I_C = 2\text{ mA}$	$V_{GE(TH)}$	4.6	5.6	6.5	V
Gate Leakage Current	$V_{GE} = 20\text{ V}, V_{CE} = 0\text{ V}$	$I_{GES}$	–	–	300	nA
Turn-on Delay Time	$T_J = 25^\circ\text{C}$ $V_{CE} = 350\text{ V}, I_C = 60\text{ A}$ $V_{GE} = \pm 15\text{ V}, R_G = 4.7\ \Omega$	$t_{d(on)}$	–	51	–	ns
Rise Time		$t_r$	–	27	–	
Turn-off Delay Time		$t_{d(off)}$	–	200	–	
Fall Time		$t_f$	–	40	–	
Turn-on Switching Loss per Pulse		$E_{on}$	–	0.74	–	
Turn off Switching Loss per Pulse	$E_{off}$	–	1.41	–		
Turn-on Delay Time	$T_J = 125^\circ\text{C}$ $V_{CE} = 350\text{ V}, I_C = 60\text{ A}$ $V_{GE} = \pm 15\text{ V}, R_G = 4.7\ \Omega$	$t_{d(on)}$	–	45	–	ns
Rise Time		$t_r$	–	30	–	
Turn-off Delay Time		$t_{d(off)}$	–	230	–	
Fall Time		$t_f$	–	110	–	
Turn-on Switching Loss per Pulse		$E_{on}$	–	1.11	–	
Turn off Switching Loss per Pulse	$E_{off}$	–	2.17	–		
Input Capacitance	$V_{CE} = 20\text{ V}, V_{GE} = 0\text{ V}, f = 10\text{ kHz}$	$C_{ies}$	–	18150	–	pF
Output Capacitance		$C_{oes}$	–	345	–	
Reverse Transfer Capacitance		$C_{res}$	–	295	–	
Total Gate Charge	$V_{CE} = 600\text{ V}, I_C = 80\text{ A}, V_{GE} = \pm 15\text{ V}$	$Q_g$	–	817	–	nC
Thermal Resistance – chip-to–heatsink	Thermal grease, Thickness = 76 $\mu\text{m}$ , $\lambda = 2.9\text{ W/mK}$	$R_{thJH}$	–	0.51	–	$^\circ\text{C/W}$

### NEUTRAL POINT DIODE CHARACTERISTICS

Diode Forward Voltage	$I_F = 50\text{ A}, T_J = 25^\circ\text{C}$	$V_F$	–	1.38	2.1	V
	$I_F = 50\text{ A}, T_J = 150^\circ\text{C}$		–	1.27	–	
Reverse Recovery Time	$T_J = 25^\circ\text{C}$ $V_{CE} = 350\text{ V}, I_C = 60\text{ A}$ $V_{GE} = \pm 15\text{ V}, R_G = 4.7\ \Omega$	$t_{rr}$	–	32	–	ns
Reverse Recovery Charge		$Q_{rr}$	–	1.35	–	$\mu\text{C}$
Peak Reverse Recovery Current		$I_{RRM}$	–	64	–	A
Peak Rate of Fall of Recovery Current		$di/dt$	–	1100	–	$\text{A}/\mu\text{s}$
Reverse Recovery Energy		$E_{rr}$	–	280	–	$\mu\text{J}$
Reverse Recovery Time	$T_J = 125^\circ\text{C}$ $V_{CE} = 350\text{ V}, I_C = 60\text{ A}$ $V_{GE} = \pm 15\text{ V}, R_G = 4.7\ \Omega$	$t_{rr}$	–	85	–	ns
Reverse Recovery Charge		$Q_{rr}$	–	3	–	$\mu\text{C}$
Peak Reverse Recovery Current		$I_{RRM}$	–	78	–	A
Peak Rate of Fall of Recovery Current		$di/dt$	–	6500	–	$\text{A}/\mu\text{s}$
Reverse Recovery Energy		$E_{rr}$	–	1390	–	$\mu\text{J}$
Thermal Resistance – chip-to–heatsink	Thermal grease, Thickness = 76 $\mu\text{m}$ , $\lambda = 2.9\text{ W/mK}$	$R_{thJH}$	–	1.39	–	$^\circ\text{C/W}$

### NEUTRAL POINT IGBT CHARACTERISTICS

Collector–Emitter Cutoff Current	$V_{GE} = 0\text{ V}, V_{CE} = 600\text{ V}$	$I_{CES}$	–	–	200	$\mu\text{A}$
Collector–Emitter Saturation Voltage	$V_{GE} = 15\text{ V}, I_C = 50\text{ A}, T_J = 25^\circ\text{C}$	$V_{CE(sat)}$	–	1.0	1.4	V
	$V_{GE} = 15\text{ V}, I_C = 50\text{ A}, T_J = 150^\circ\text{C}$		–	0.93	–	
Gate–Emitter Threshold Voltage	$V_{GE} = V_{CE}, I_C = 250\ \mu\text{A}$	$V_{GE(TH)}$	3	3.6	5	V
Gate Leakage Current	$V_{GE} = 20\text{ V}, V_{CE} = 0\text{ V}$	$I_{GES}$	–	–	500	nA

# NXH80T120L3Q0S3G/S3TG, NXH80T120L3Q0P3G

**Table 2. ELECTRICAL CHARACTERISTICS**  $T_J = 25^\circ\text{C}$  unless otherwise noted

Parameter	Test Conditions	Symbol	Min	Typ	Max	Unit	
<b>NEUTRAL POINT IGBT CHARACTERISTICS</b>							
Turn-on Delay Time	$T_J = 25^\circ\text{C}$ $V_{CE} = 350\text{ V}, I_C = 60\text{ A}$ $V_{GE} = \pm 15\text{ V}, R_G = 20\ \Omega$	$t_{d(on)}$	-	65	-	ns	
Rise Time		$t_r$	-	20	-		
Turn-off Delay Time		$t_{d(off)}$	-	660	-		
Fall Time		$t_f$	-	20	-		
Turn-on Switching Loss per Pulse			$E_{on}$	-	1.37	-	mJ
Turn off Switching Loss per Pulse			$E_{off}$	-	0.9	-	
Turn-on Delay Time	$T_J = 125^\circ\text{C}$ $V_{CE} = 350\text{ V}, I_C = 60\text{ A}$ $V_{GE} = \pm 15\text{ V}, R_G = 20\ \Omega$	$t_{d(on)}$	-	70	-	ns	
Rise Time		$t_r$	-	28	-		
Turn-off Delay Time		$t_{d(off)}$	-	720	-		
Fall Time		$t_f$	-	30	-		
Turn-on Switching Loss per Pulse			$E_{on}$	-	2.45	-	mJ
Turn off Switching Loss per Pulse			$E_{off}$	-	1.0	-	
Input Capacitance	$V_{CE} = 20\text{ V}, V_{GE} = 0\text{ V}, f = 10\text{ kHz}$	$C_{ies}$	-	16881	-	pF	
Output Capacitance		$C_{oes}$	-	107	-		
Reverse Transfer Capacitance		$C_{res}$	-	94	-		
Total Gate Charge	$V_{CE} = 480\text{ V}, I_C = 50\text{ A}, V_{GE} = \pm 15\text{ V}$	$Q_g$	-	830	-	nC	
Thermal Resistance – chip-to-heatsink	Thermal grease, Thickness = 76 $\mu\text{m}$ , $\lambda = 2.9\text{ W/mK}$	$R_{thJH}$	-	1.16	-	$^\circ\text{C/W}$	

### HALF BRIDGE DIODE CHARACTERISTICS

Diode Forward Voltage	$I_F = 40\text{ A}, T_J = 25^\circ\text{C}$	$V_F$	-	2.43	3.10	V
	$I_F = 40\text{ A}, T_J = 150^\circ\text{C}$		-	1.63	-	
Reverse recovery time	$T_J = 25^\circ\text{C}$ $V_{CE} = 350\text{ V}, I_C = 60\text{ A}$ $V_{GE} = \pm 15\text{ V}, R_G = 62\ \Omega$	$t_{rr}$	-	45	-	ns
Reverse recovery charge		$Q_{rr}$	-	2	-	$\mu\text{C}$
Peak reverse recovery current		$I_{RRM}$	-	140	-	A
Peak rate of fall of recovery current		$di/dt$	-	860	-	$\text{A}/\mu\text{s}$
Reverse recovery energy		$E_{rr}$	-	310	-	$\mu\text{J}$
Reverse recovery time		$T_J = 125^\circ\text{C}$ $V_{CE} = 350\text{ V}, I_C = 60\text{ A}$ $V_{GE} = \pm 15\text{ V}, R_G = 62\ \Omega$	$t_{rr}$	-	75	-
Reverse recovery charge	$Q_{rr}$		-	5.5	-	$\mu\text{C}$
Peak reverse recovery current	$I_{RRM}$		-	125	-	A
Peak rate of fall of recovery current	$di/dt$		-	740	-	$\text{A}/\mu\text{s}$
Reverse recovery energy	$E_{rr}$		-	640	-	$\mu\text{J}$
Thermal Resistance – chip-to-heatsink	Thermal grease, Thickness = 76 $\mu\text{m}$ , $\lambda = 2.9\text{ W/mK}$		$R_{thJH}$	-	1.2	-

### THERMISTOR CHARACTERISTICS

Nominal resistance		R	-	22	-	k $\Omega$
Nominal resistance	$T = 100^\circ\text{C}$	R	-	1468	-	$\Omega$
Deviation of R25		$\Delta R/R$	-5	-	5	%
Power dissipation		$P_D$	-	200	-	mW
Power dissipation constant			-	2	-	mW/K
B-value	B(25/50), tolerance $\pm 3\%$		-	-	3950	K
B-value	B(25/100), tolerance $\pm 3\%$		-	-	3998	K
NTC reference					B	

Product parametric performance is indicated in the Electrical Characteristics for the listed test conditions, unless otherwise noted. Product performance may not be indicated by the Electrical Characteristics if operated under different conditions.

# NXH80T120L3Q0S3G/S3TG, NXH80T120L3Q0P3G

## TYPICAL CHARACTERISTICS – HALF BRIDGE IGBT AND DIODE

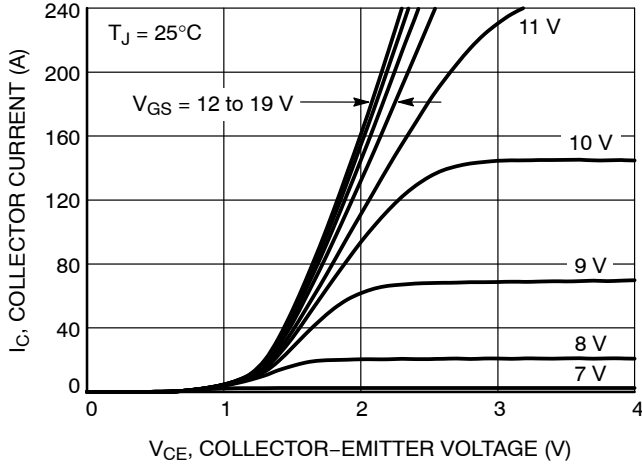

Figure 2. Typical Output Characteristics

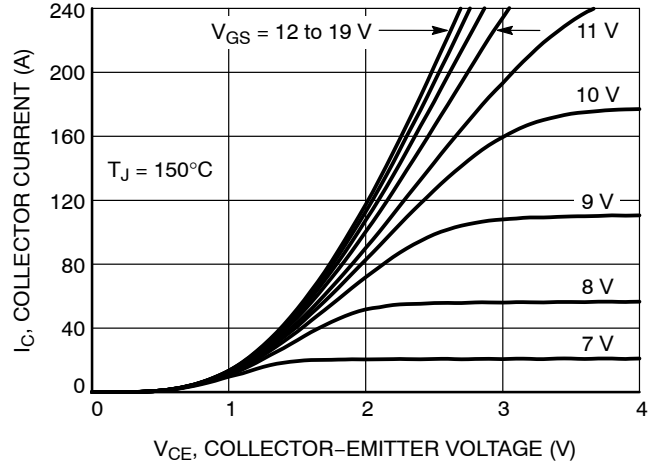

Figure 3. Typical Output Characteristics

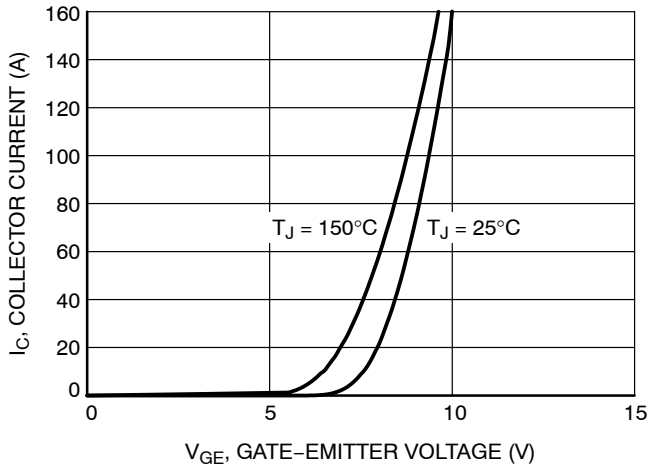

Figure 4. Typical Transfer Characteristics

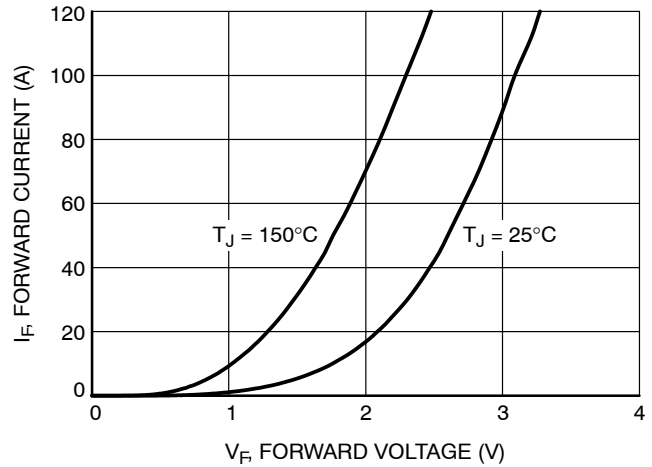

Figure 5. Typical Diode Forward Characteristics

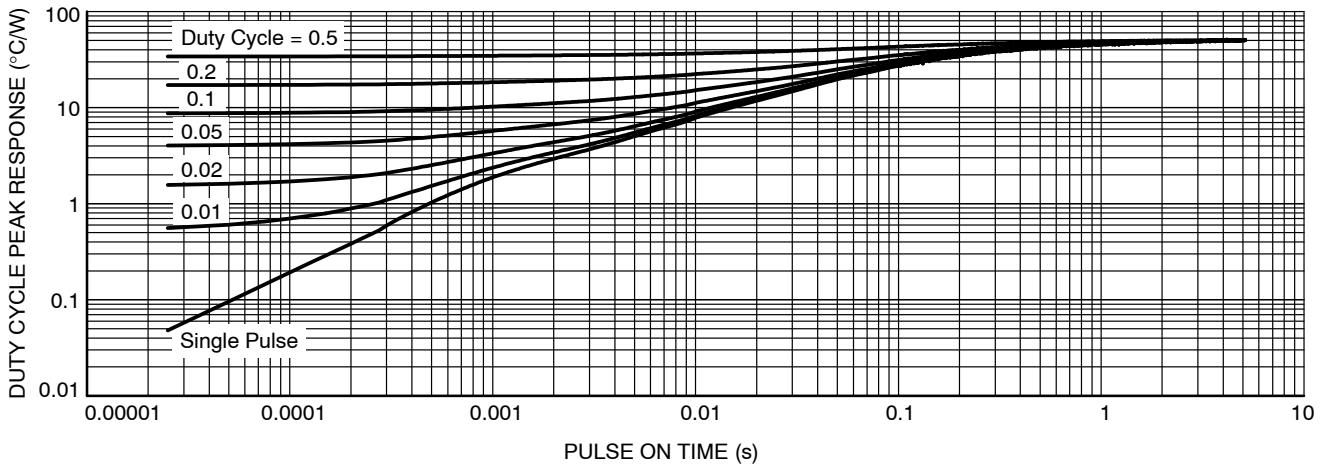

Figure 6. Transient Thermal Impedance (Half Bridge IGBT)

# NXH80T120L3Q0S3G/S3TG, NXH80T120L3Q0P3G

## TYPICAL CHARACTERISTICS – HALF BRIDGE IGBT AND DIODE

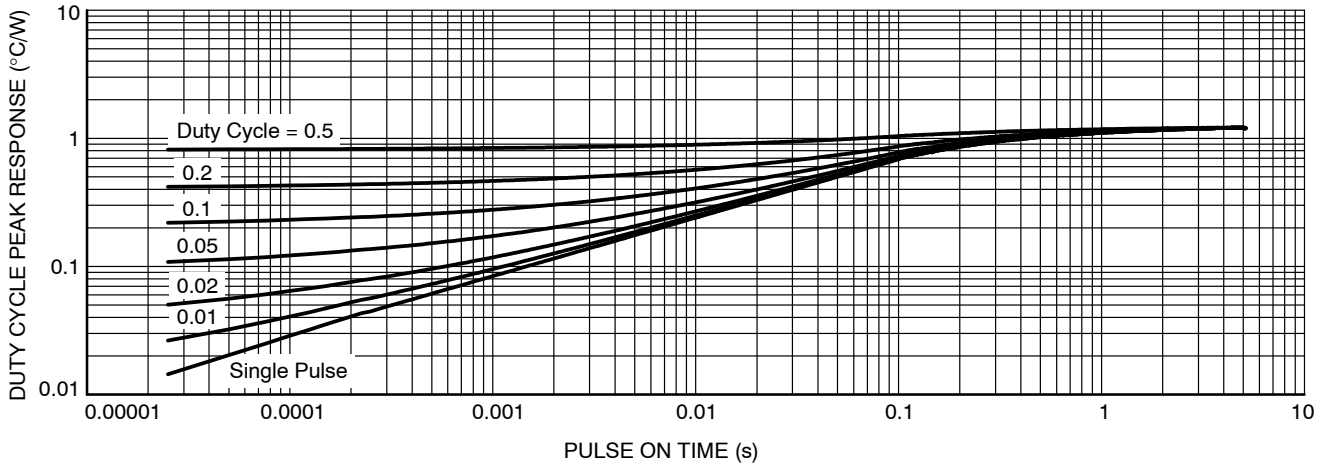

Figure 7. Transient Thermal Impedance (Half Bridge Diode)

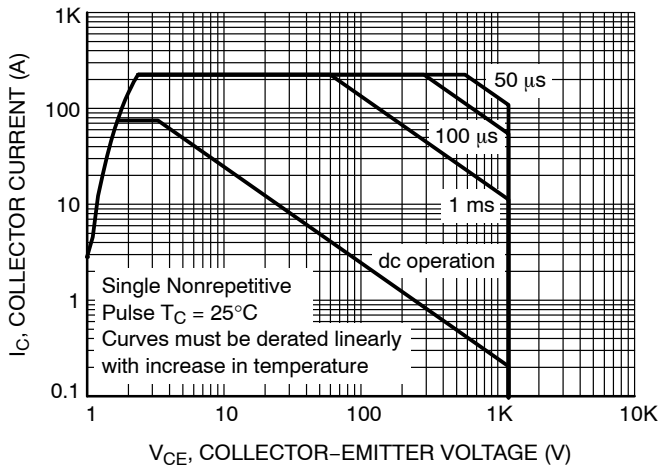

Figure 8. FB Safe Operating Area

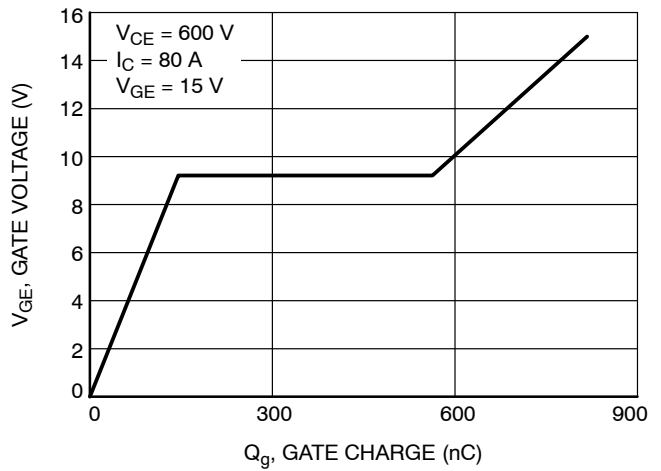

Figure 9. Gate Voltage vs. Gate Charge

TYPICAL CHARACTERISTICS – NEUTRAL POINT IGBT AND DIODE

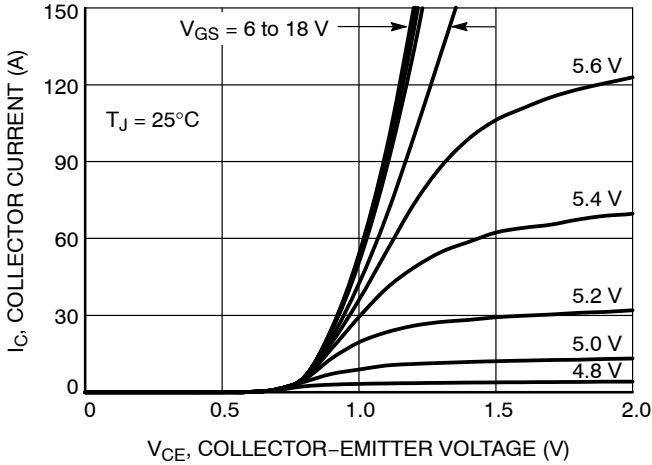

Figure 10. Typical Output Characteristics

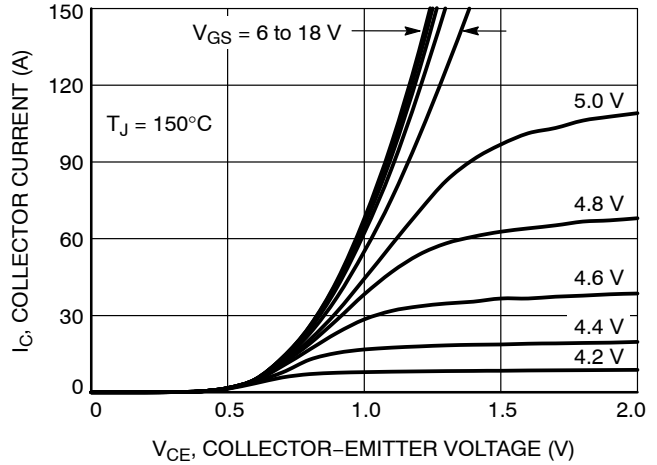

Figure 11. Typical Output Characteristics

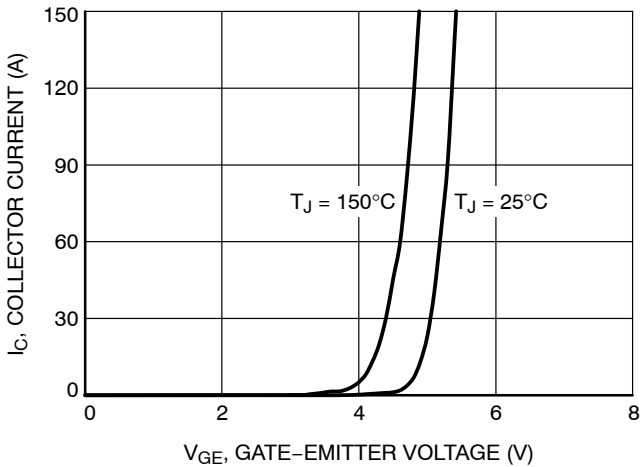

Figure 12. Typical Transfer Characteristics

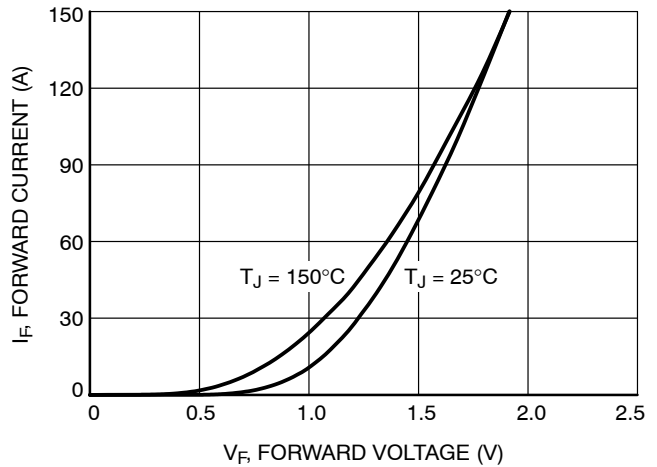

Figure 13. Typical Diode Forward Characteristics

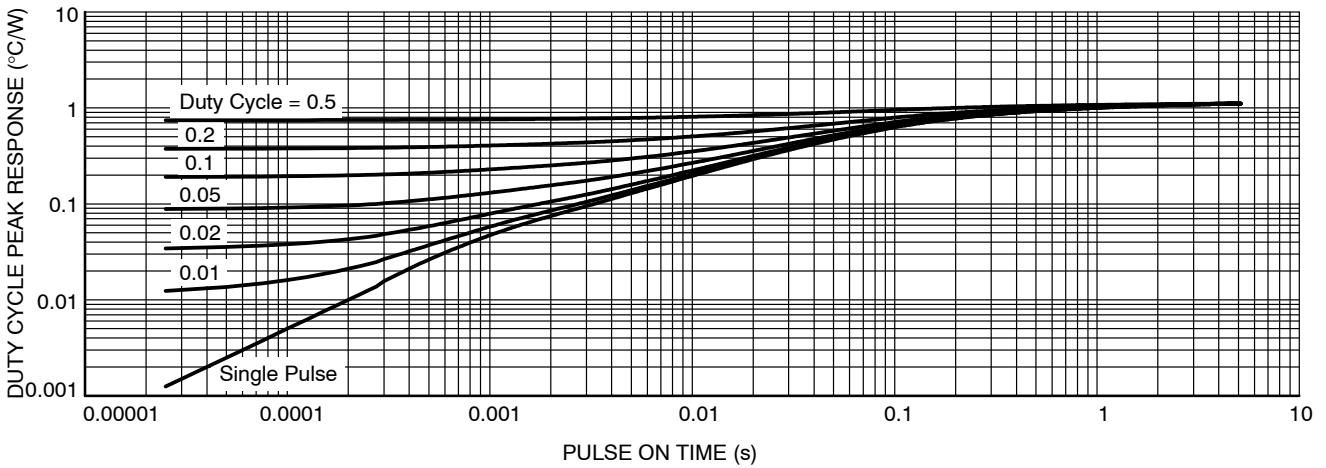

Figure 14. Transient Thermal Impedance (Neutral Point IGBT)

# NXH80T120L3Q0S3G/S3TG, NXH80T120L3Q0P3G

## TYPICAL CHARACTERISTICS – NEUTRAL POINT IGBT AND DIODE

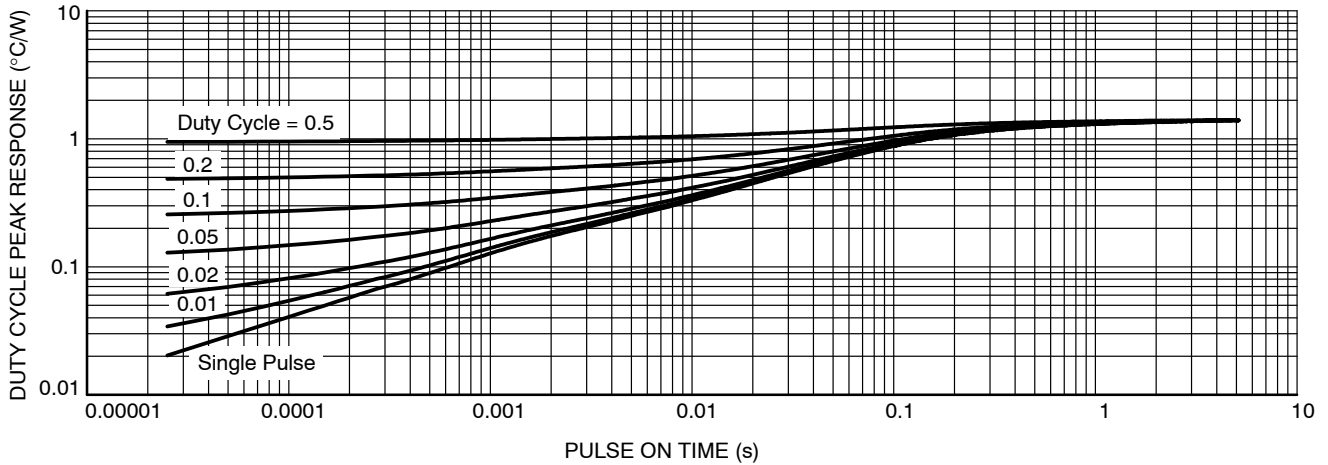

Figure 15. Transient Thermal Impedance (Neutral Point Diode)

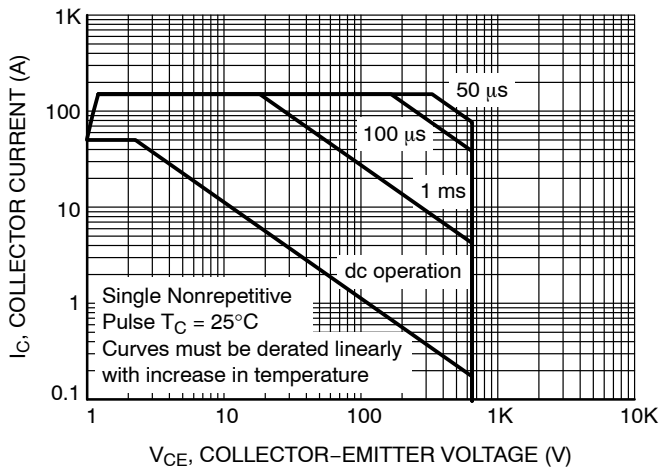

Figure 16. FB Safe Operating Area

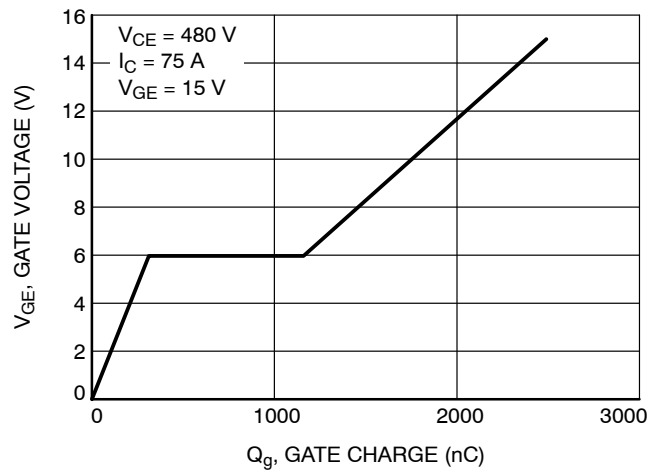

Figure 17. Gate Voltage vs. Gate Charge



TYPICAL CHARACTERISTICS – HALF BRIDGE IGBT COMMUTATES NEUTRAL POINT DIODE

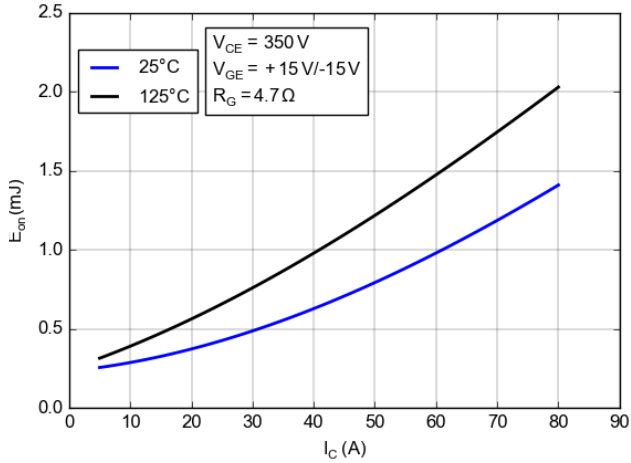

Figure 18. Typical Turn On Loss vs.  $I_C$

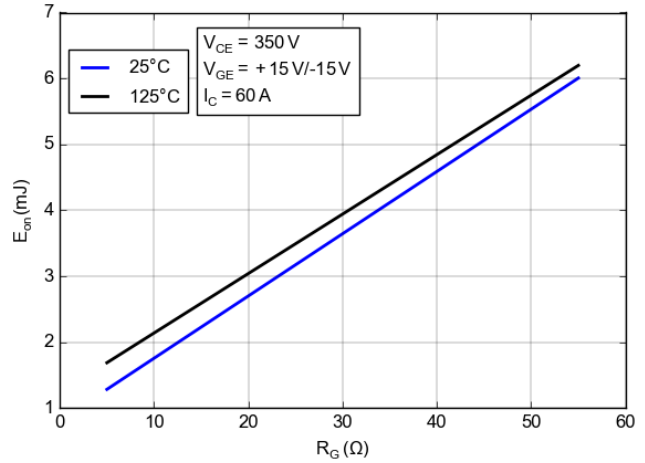

Figure 19. Typical Turn On Loss vs.  $R_G$

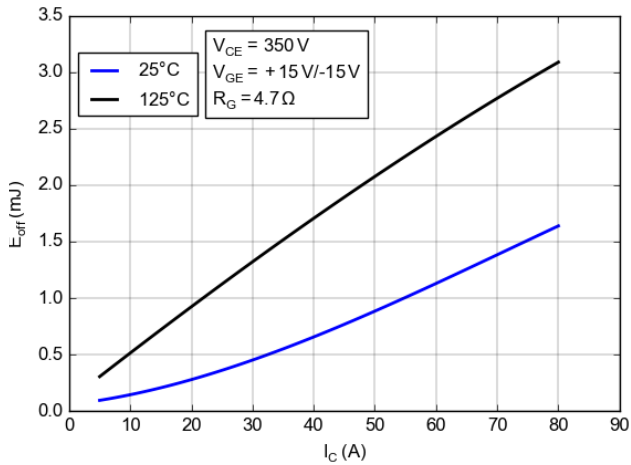

Figure 20. Typical Turn Off Loss vs.  $I_C$

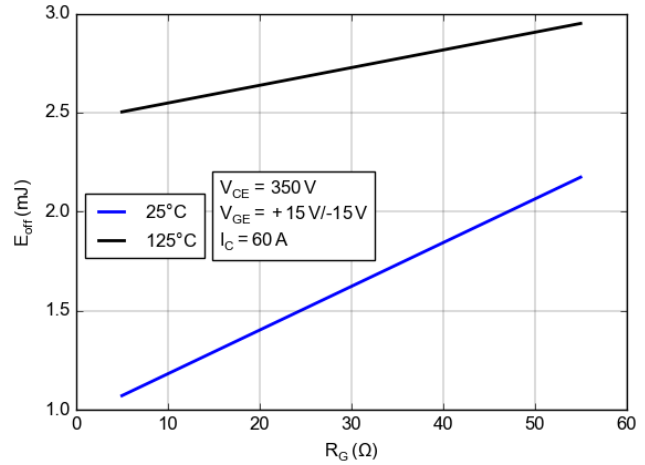

Figure 21. Typical Turn Off Loss vs.  $R_G$

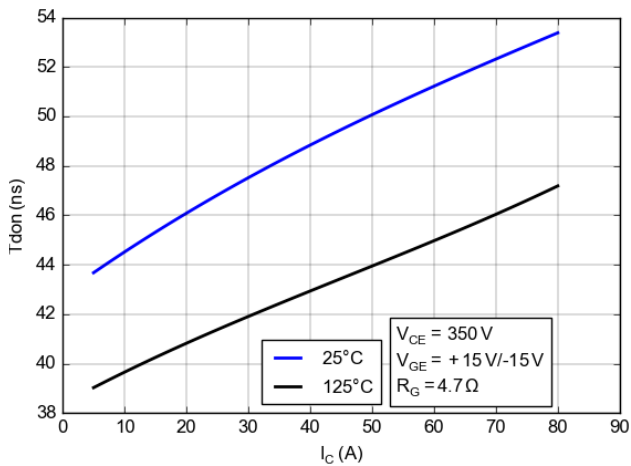

Figure 22. Typical Switching Times  $T_{don}$  vs.  $I_C$

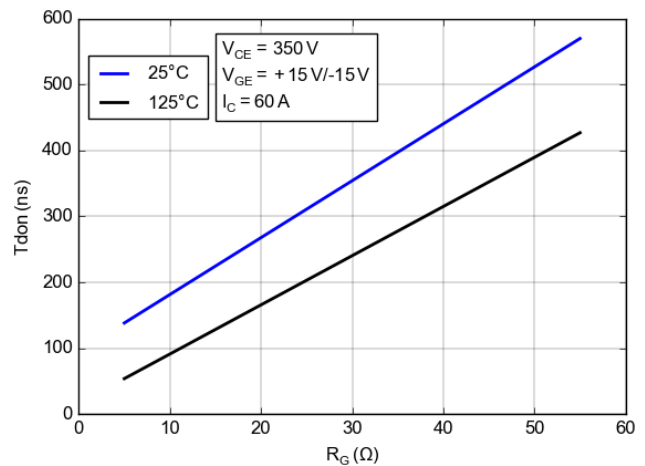

Figure 23. Typical Switching Times  $T_{don}$  vs.  $R_G$

TYPICAL CHARACTERISTICS – HALF BRIDGE IGBT COMMUTATES NEUTRAL POINT DIODE

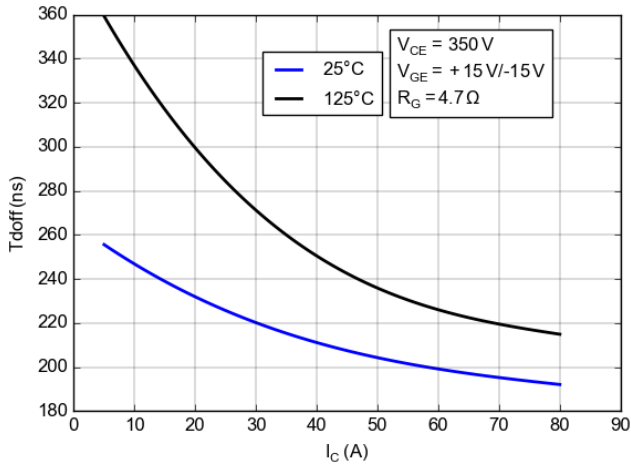

Figure 24. Typical Switching Times Tdoff vs.  $I_C$

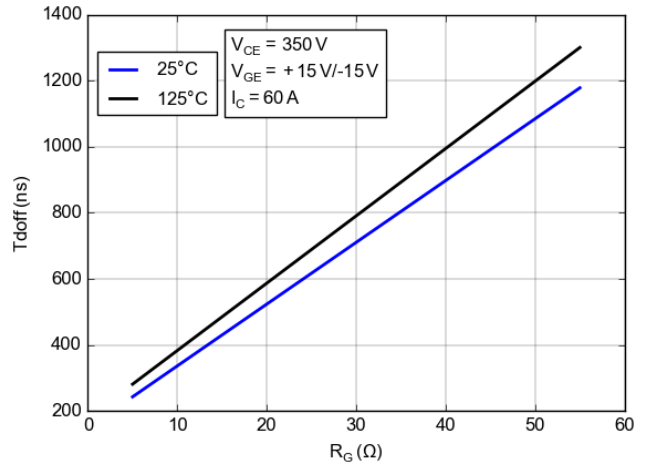

Figure 25. Typical Switching Times Tdoff vs.  $R_G$

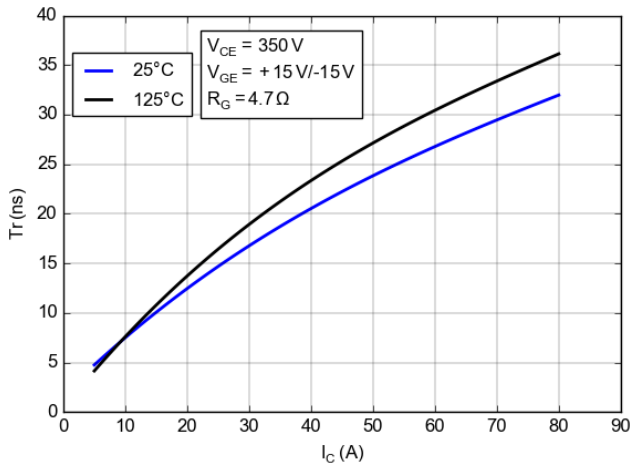

Figure 26. Typical Switching Times Tron vs.  $I_C$

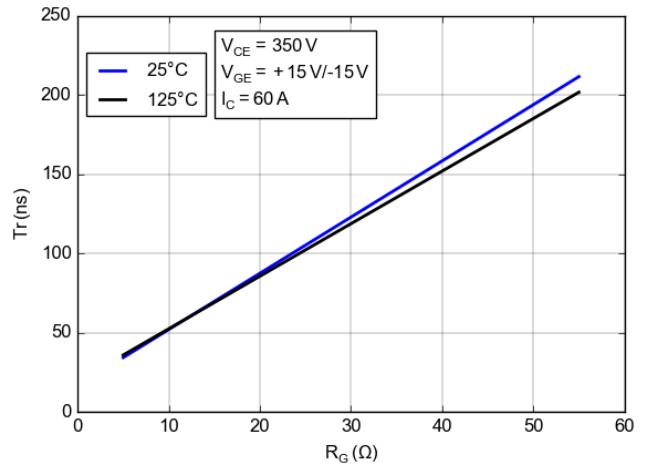

Figure 27. Typical Switching Times Tron vs.  $R_G$

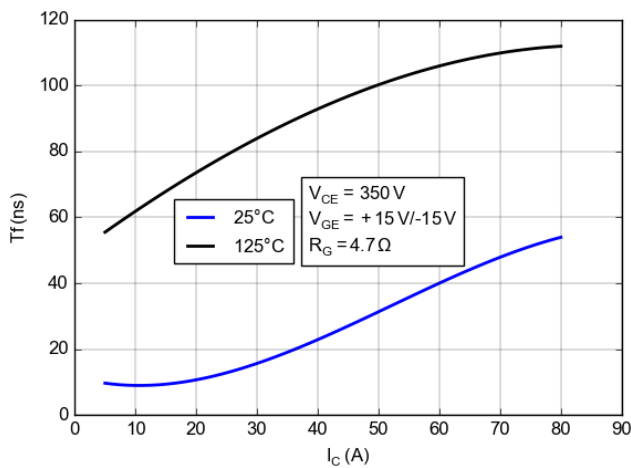

Figure 28. Typical Switching Times Tf vs.  $I_C$

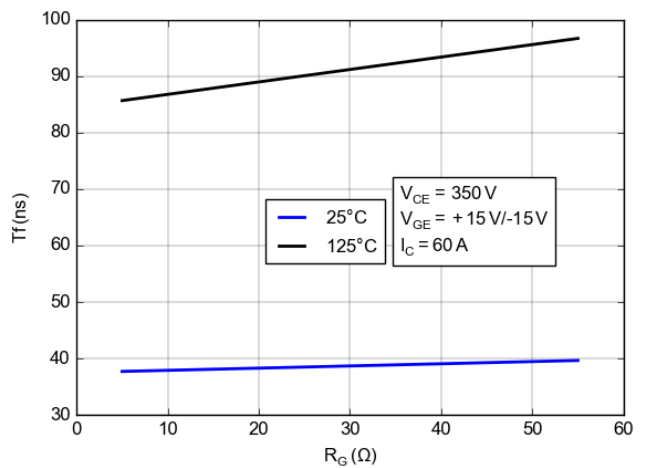

Figure 29. Typical Switching Times Tf vs.  $R_G$

TYPICAL CHARACTERISTICS – HALF BRIDGE IGBT COMMUTATES NEUTRAL POINT DIODE

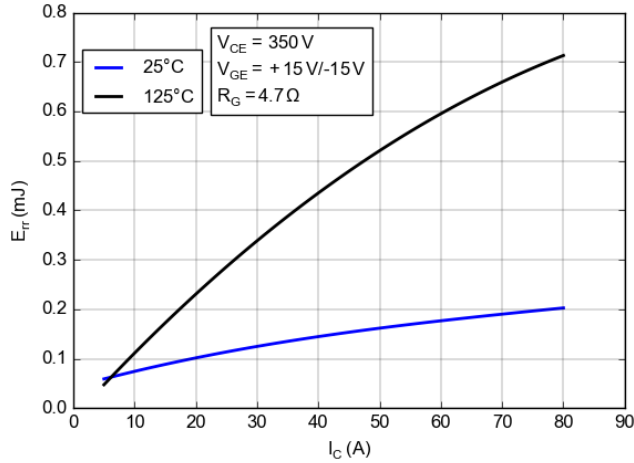

Figure 30. Typical Reverse Recovery Energy vs.  $I_C$

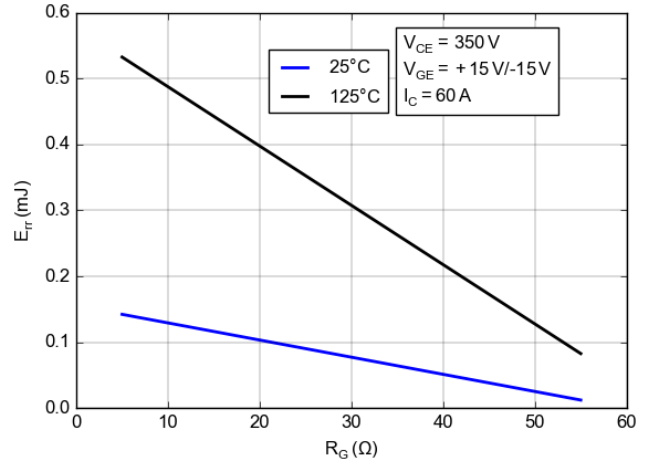

Figure 31. Typical Reverse Recovery Energy vs.  $R_G$

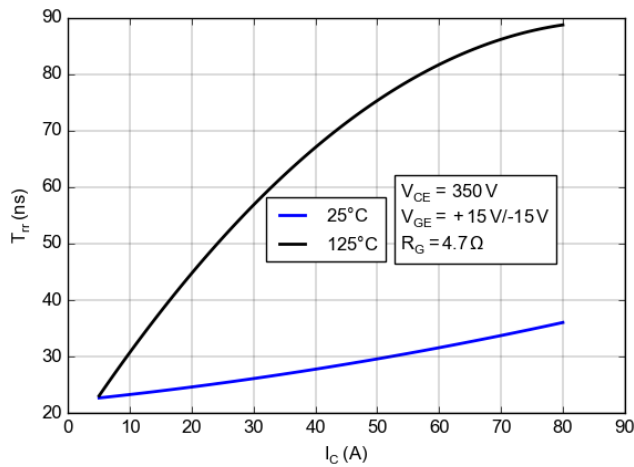

Figure 32. Typical Reverse Recovery Time vs.  $I_C$

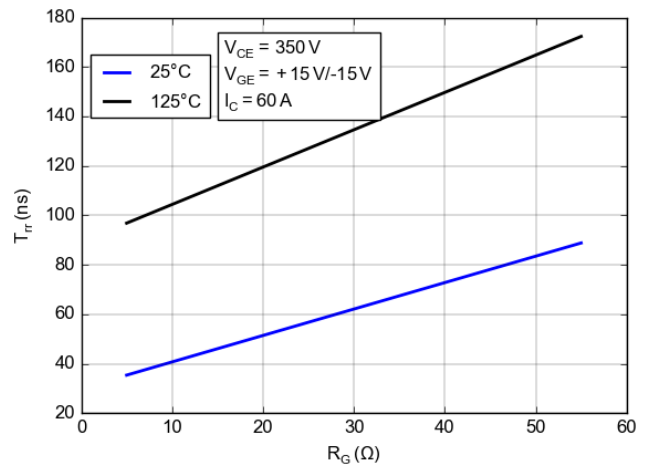

Figure 33. Typical Reverse Recovery Time vs.  $R_G$

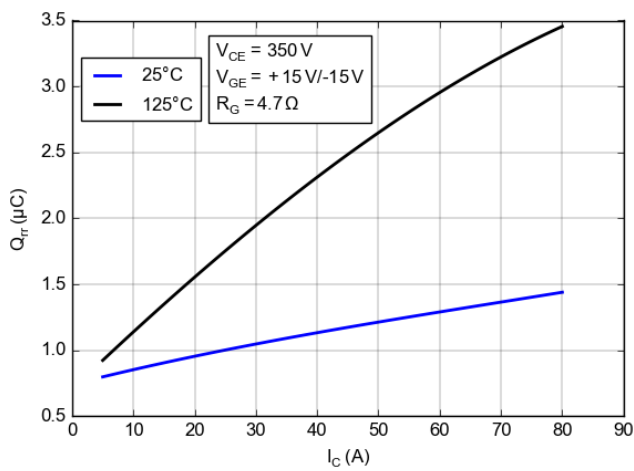

Figure 34. Typical Reverse Recovery Charge vs.  $I_C$

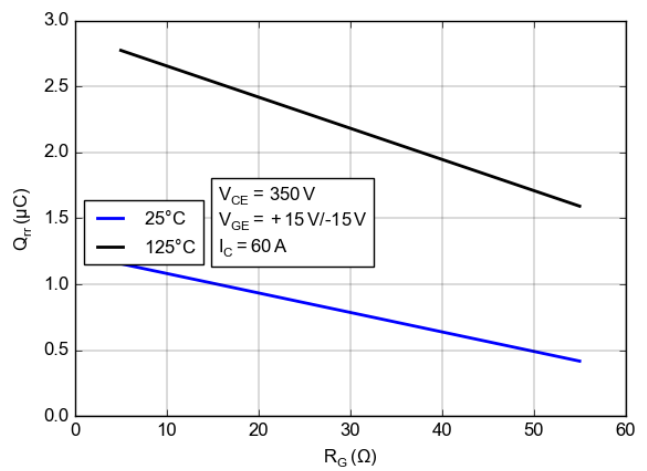

Figure 35. Typical Reverse Recovery Charge vs.  $R_G$

# NXH80T120L3Q0S3G/S3TG, NXH80T120L3Q0P3G

## TYPICAL CHARACTERISTICS – HALF BRIDGE IGBT COMMUTATES NEUTRAL POINT DIODE

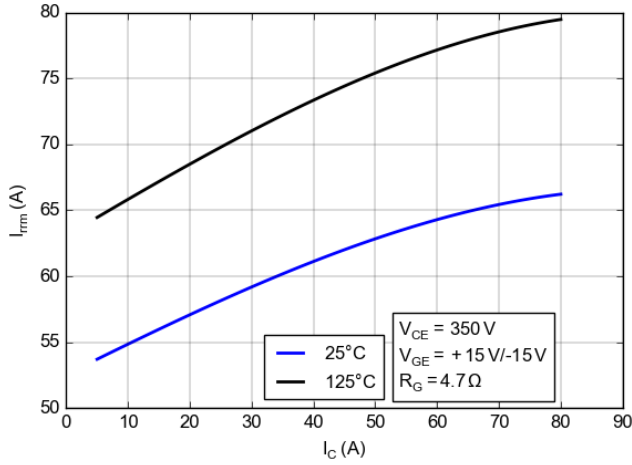

Figure 36. Typical Reverse Recovery Current vs.  $I_C$

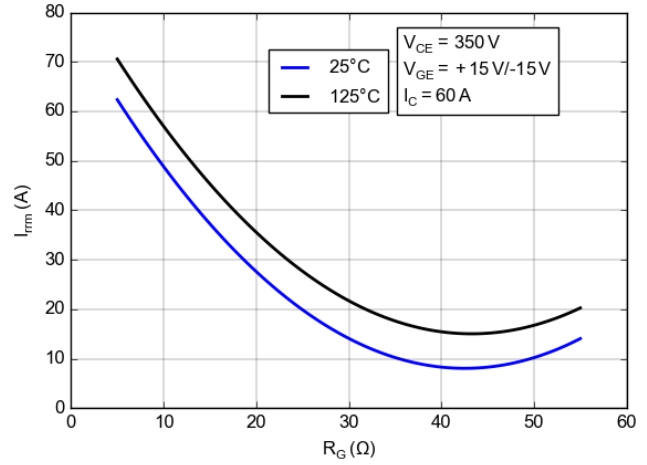

Figure 37. Typical Reverse Recovery Current vs.  $R_G$

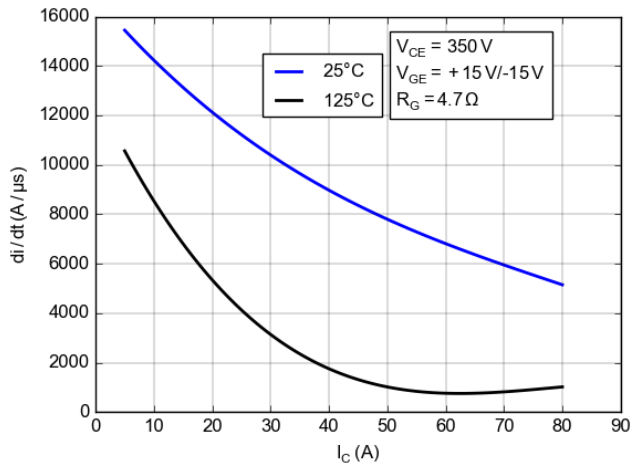

Figure 38. Typical  $di/dt$  vs.  $I_C$

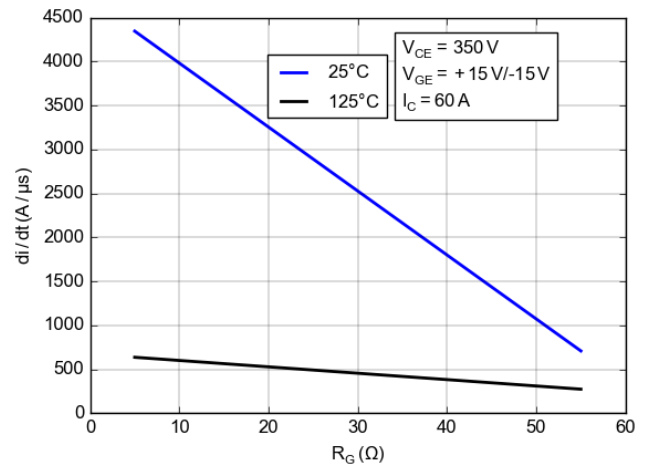

Figure 39. Typical  $di/dt$  vs.  $R_G$

TYPICAL CHARACTERISTICS – NEUTRAL POINT IGBT COMMUTATES HALF BRIDGE DIODE

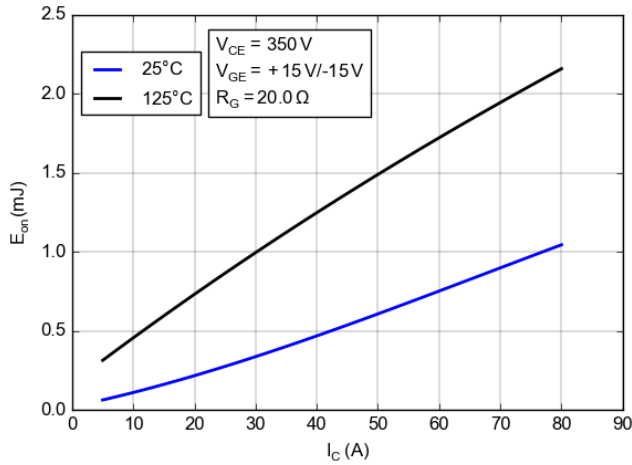

Figure 40. Typical Turn On Loss vs.  $I_C$

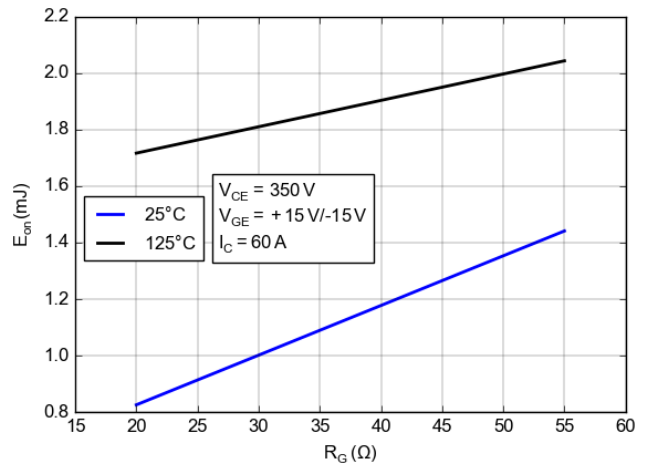

Figure 41. Typical Turn On Loss vs.  $R_G$

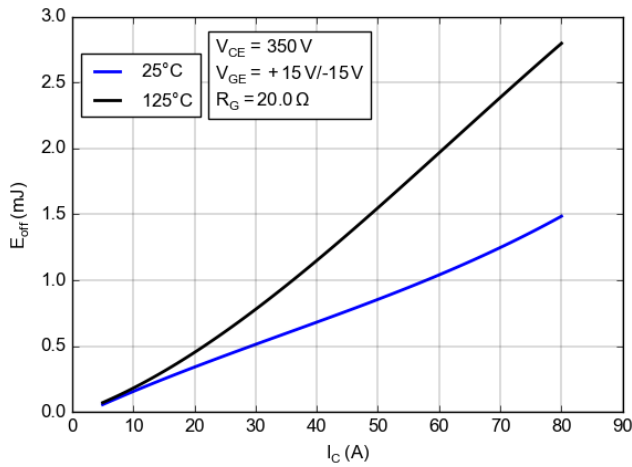

Figure 42. Typical Turn Off Loss vs.  $I_C$

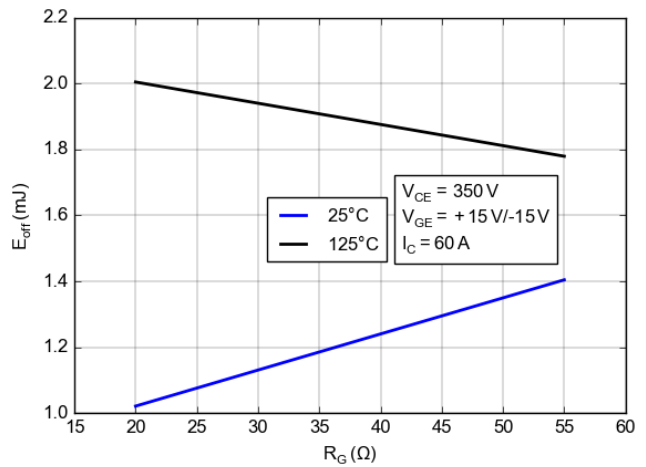

Figure 43. Typical Turn Off Loss vs.  $R_G$

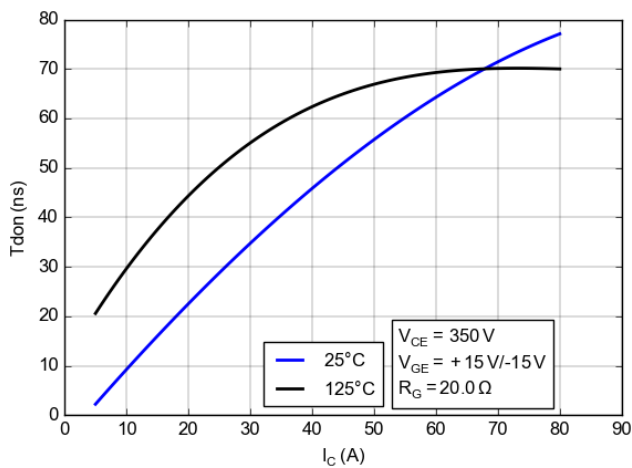

Figure 44. Typical Switching Times  $T_{don}$  vs.  $I_C$

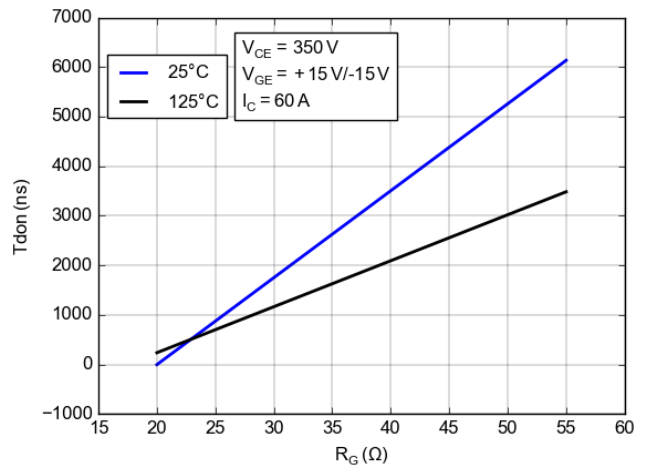

Figure 45. Typical Switching Times  $T_{don}$  vs.  $R_G$

TYPICAL CHARACTERISTICS – NEUTRAL POINT IGBT COMMUTATES HALF BRIDGE DIODE

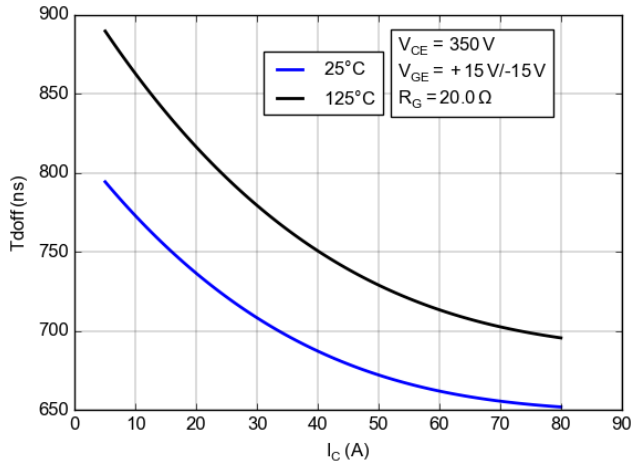

Figure 46. Typical Switching Times Tdoff vs.  $I_C$

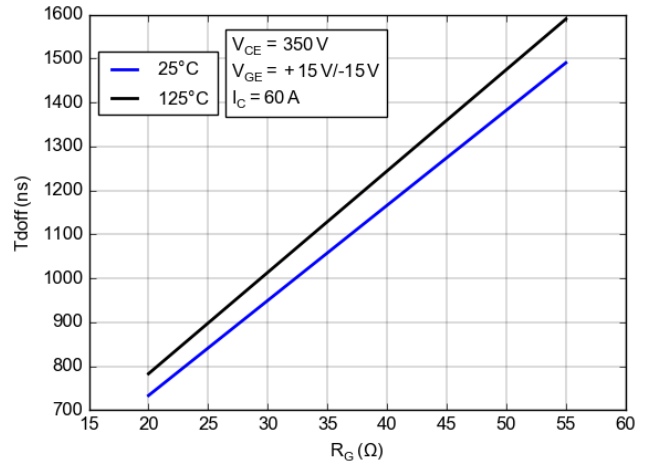

Figure 47. Typical Switching Times Tdoff vs.  $R_G$

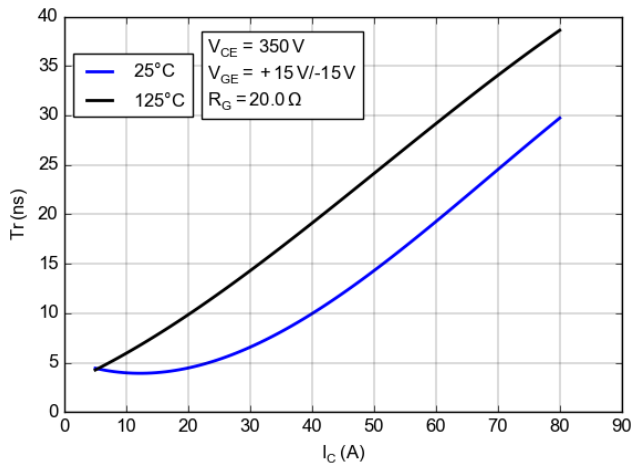

Figure 48. Typical Switching Times Tron vs.  $I_C$

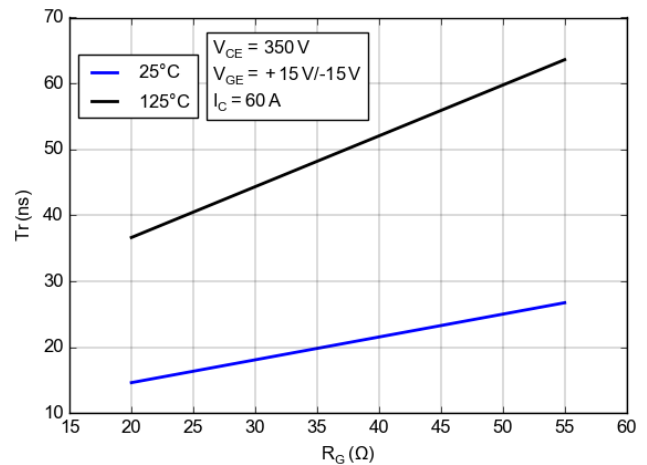

Figure 49. Typical Switching Times Tron vs.  $R_G$

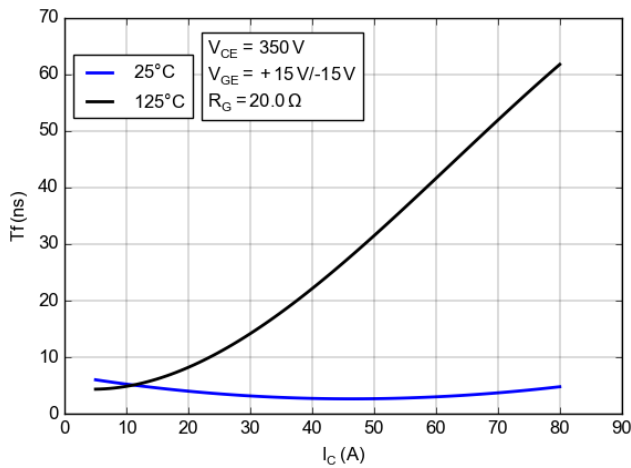

Figure 50. Typical Switching Times Tf vs.  $I_C$

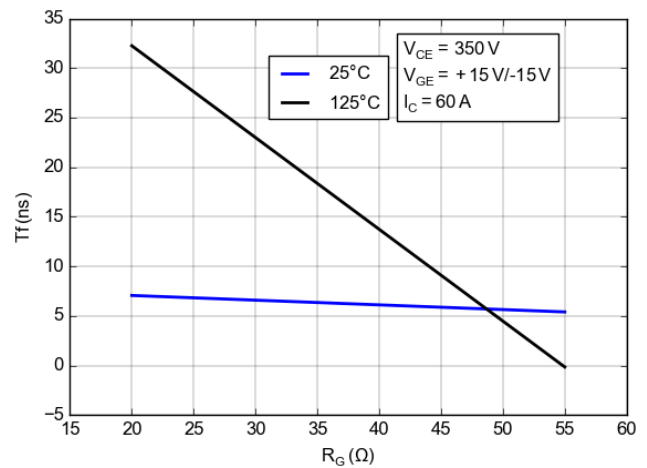

Figure 51. Typical Switching Times Tf vs.  $R_G$

TYPICAL CHARACTERISTICS – NEUTRAL POINT IGBT COMMUTATES HALF BRIDGE DIODE

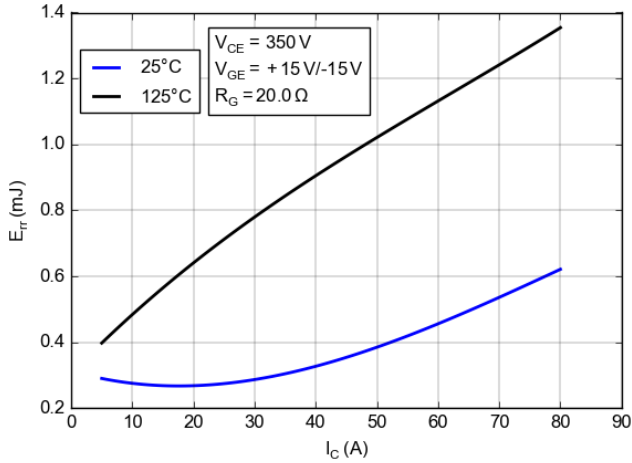

Figure 52. Typical Reverse Recovery Energy vs.  $I_C$

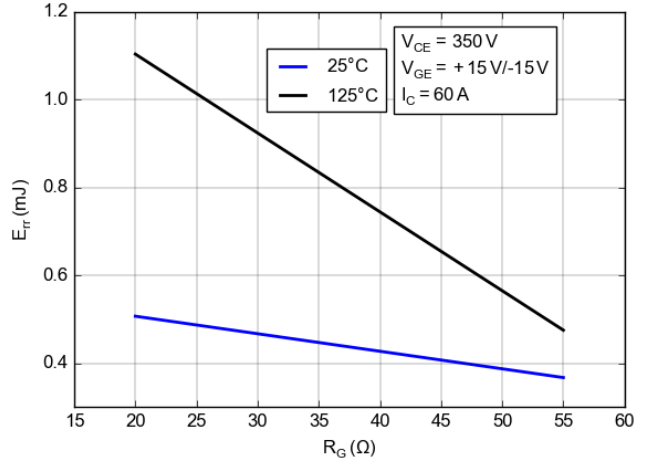

Figure 53. Typical Reverse Recovery Energy vs.  $R_G$

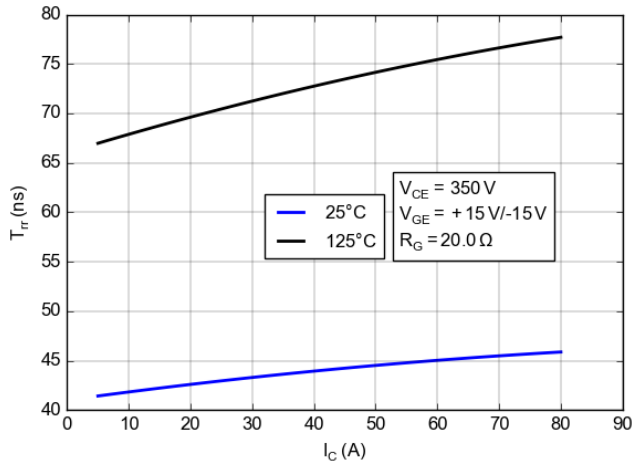

Figure 54. Typical Reverse Recovery Time vs.  $I_C$

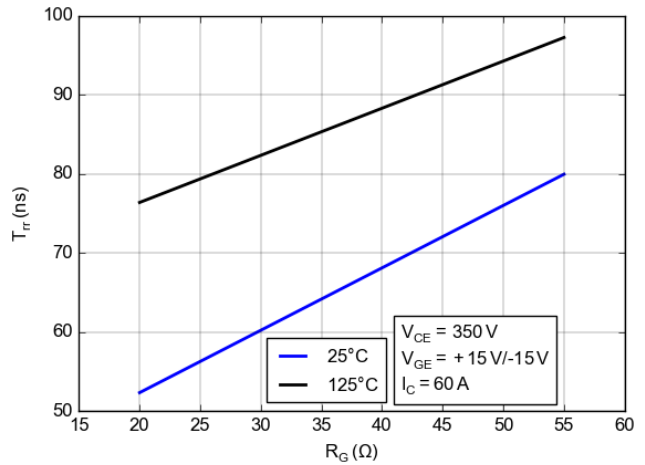

Figure 55. Typical Reverse Recovery Time vs.  $R_G$

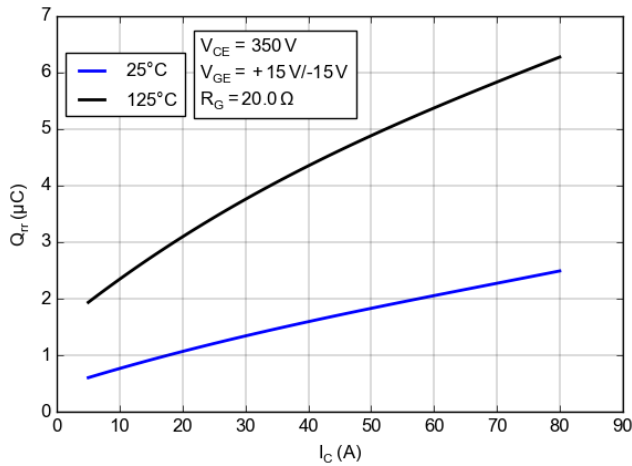

Figure 56. Typical Reverse Recovery Charge vs.  $I_C$

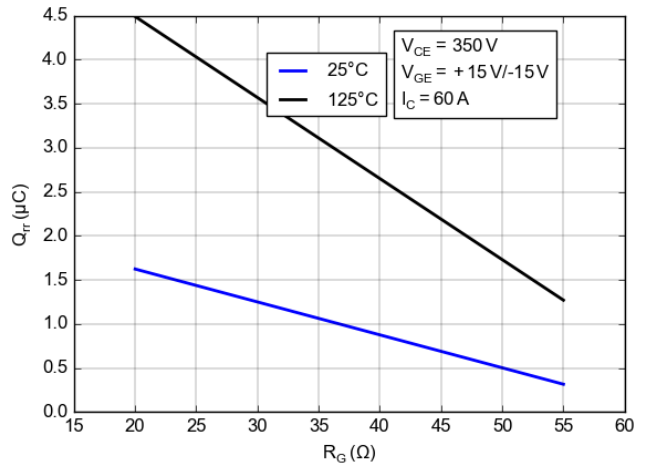
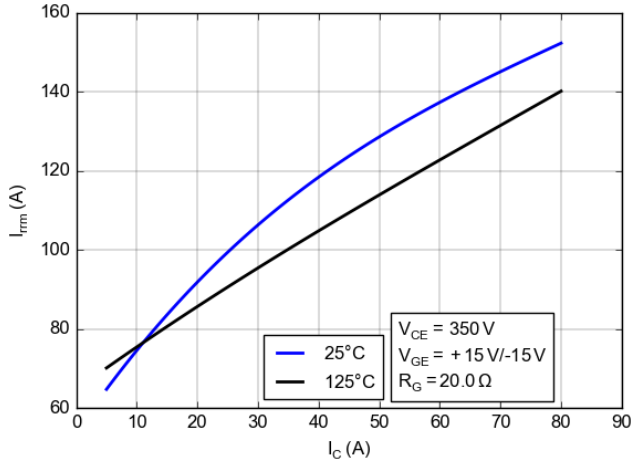

Figure 57. Typical Reverse Recovery Charge vs.  $R_G$

# NXH80T120L3Q0S3G/S3TG, NXH80T120L3Q0P3G

## TYPICAL CHARACTERISTICS – NEUTRAL POINT IGBT COMMUTATES HALF BRIDGE DIODE



**Figure 58. Typical Reverse Recovery Current vs.  $I_C$**

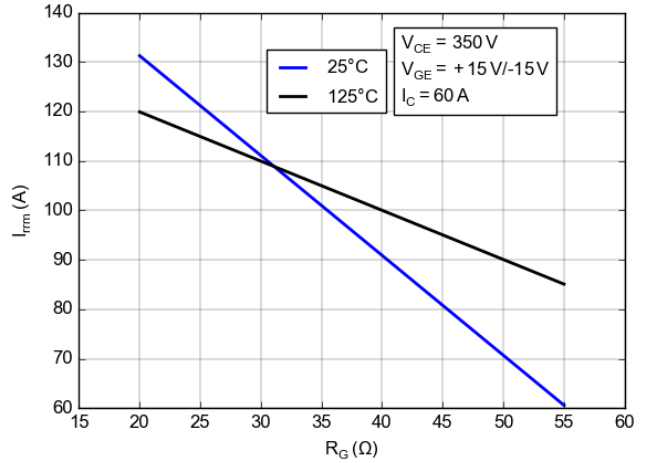

**Figure 59. Typical Reverse Recovery Current vs.  $R_G$**

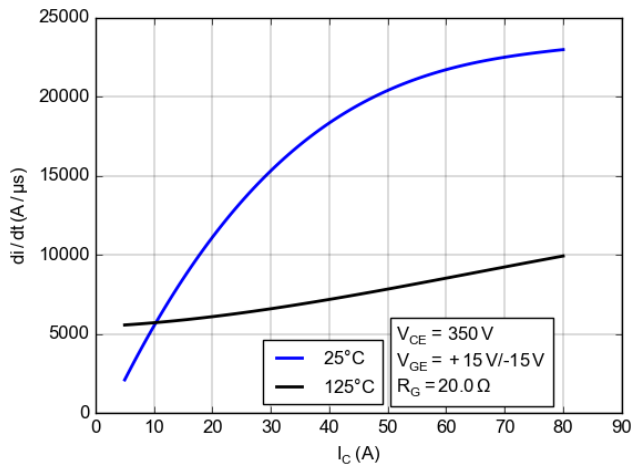

**Figure 60. Typical di/dt vs  $I_C$**

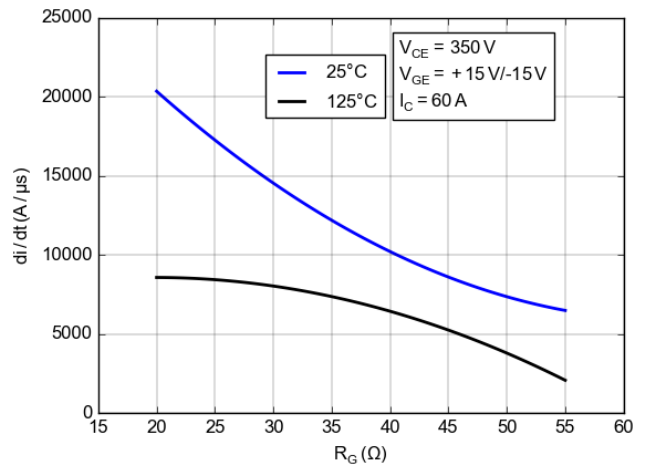

**Figure 61. Typical di/dt vs  $R_G$**

### ORDERING INFORMATION

Orderable Part Number	Marking	Package	Shipping
NXH80T120L3Q0P3G	NXH80T120L3Q0P3G	Q0PACK – Case 180AA (Pb-Free and Halide-Free)	24 Units / Blister Tray
NXH80T120L3Q0S3G	NXH80T120L3Q0S3G	Q0PACK – Case 180AB (Pb-Free and Halide-Free)	24 Units / Blister Tray
NXH80T120L3Q0S3TG	NXH80T120L3Q0S3TG	Q0PACK – Case 180AB with pre-applied thermal interface material (TIM) (Pb-Free and Halide-Free)	24 Units / Blister Tray



# MECHANICAL CASE OUTLINE

## PACKAGE DIMENSIONS

ON Semiconductor®



**PIM20, 55x32.5 / Q0PACK**  
**CASE 180AA**  
**ISSUE D**

DATE 07 AUG 2018

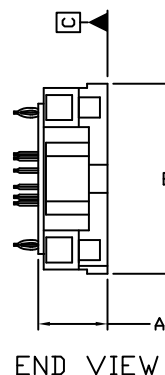
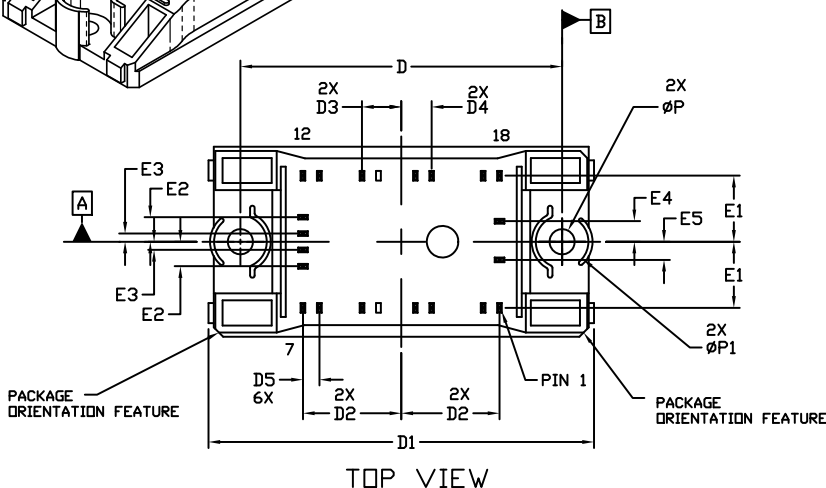
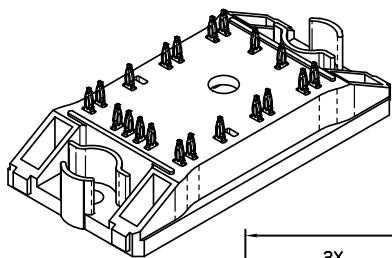

DIM	MILLIMETERS		
	MIN.	NOM.	MAX.
A	11.33	11.83	12.33
A3	15.50	16.00	16.50
A4	12.88 BSC		
b	1.61	1.66	1.71
b1	0.75	0.80	0.85
D	54.80	55.00	55.20
D1	65.70	67.90	70.10
D2	16.80 BSC		
D3	6.70 BSC		
D4	5.20 BSC		
D5	2.80 BSC		
E	32.30	32.50	32.70
E1	11.30 BSC		
E2	4.20 BSC		
E3	1.40 BSC		
E4	3.50 BSC		
E5	3.10 BSC		
P	4.10	4.30	4.50
P1	8.50	9.00	9.50

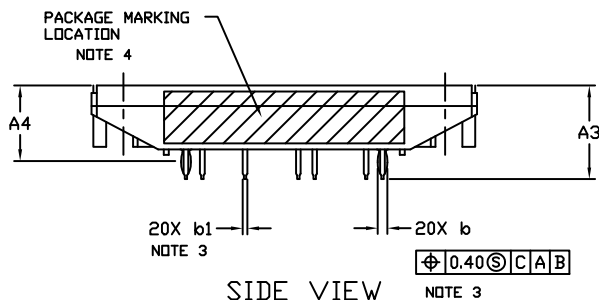

**NOTES:**

1. DIMENSIONING AND TOLERANCING PER ASME Y14.5M, 2009.
2. CONTROLLING DIMENSION: MILLIMETERS
3. DIMENSIONS b AND b1 APPLY TO THE PLATED TERMINALS AND ARE MEASURED AT DIMENSION A4.
4. PACKAGE MARKING IS LOCATED AS SHOWN ON THE SIDE OPPOSITE THE PACKAGE ORIENTATION FEATURES.

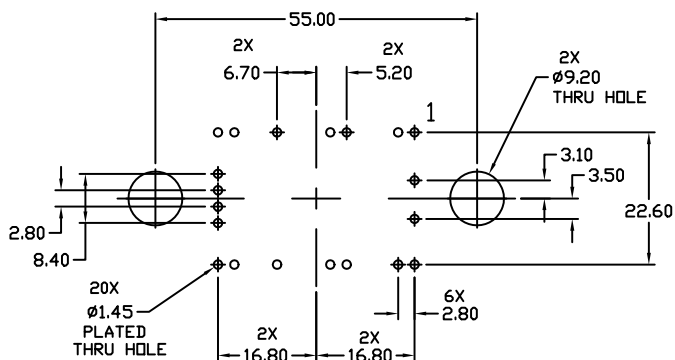

**RECOMMENDED MOUNTING PATTERN**

**GENERIC MARKING DIAGRAM\***

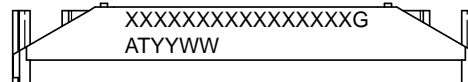

XXXXX = Specific Device Code  
 G = Pb-Free Package  
 AT = Assembly & Test Site Code  
 YYWW = Year and Work Week Code

\*This information is generic. Please refer to device data sheet for actual part marking. Pb-Free indicator, "G" or microdot "•", may or may not be present. Some products may not follow the Generic Marking.

<b>DOCUMENT NUMBER:</b>	<b>98AON95859F</b>	Electronic versions are uncontrolled except when accessed directly from the Document Repository. Printed versions are uncontrolled except when stamped "CONTROLLED COPY" in red.
<b>DESCRIPTION:</b>	<b>PIM20, 55x32.5 / Q0PACK</b>	<b>PAGE 1 OF 1</b>

ON Semiconductor and ON are trademarks of Semiconductor Components Industries, LLC dba ON Semiconductor or its subsidiaries in the United States and/or other countries. ON Semiconductor reserves the right to make changes without further notice to any products herein. ON Semiconductor makes no warranty, representation or guarantee regarding the suitability of its products for any particular purpose, nor does ON Semiconductor assume any liability arising out of the application or use of any product or circuit, and specifically disclaims any and all liability, including without limitation special, consequential or incidental damages. ON Semiconductor does not convey any license under its patent rights nor the rights of others.

# MECHANICAL CASE OUTLINE

## PACKAGE DIMENSIONS

ON Semiconductor®



### PIM20, 55x32.5 / Q0PACK CASE 180AB ISSUE D

DATE 21 NOV 2017

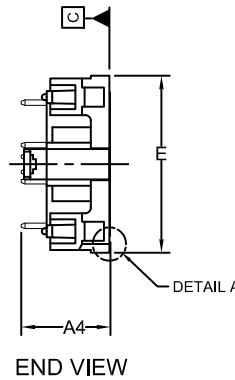
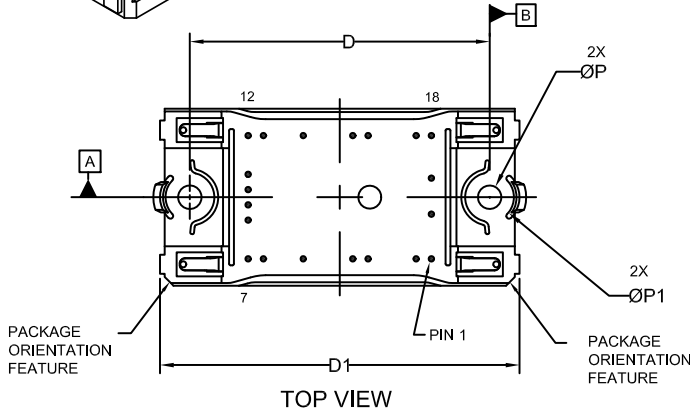
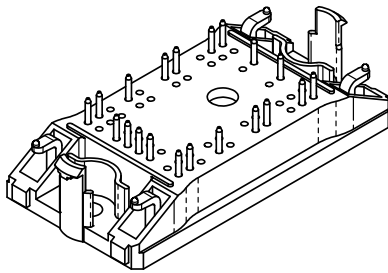

DIM	MILLIMETERS	
	MIN.	NOM.
A	13.50	13.90
A1	0.10	0.30
A2	11.50	11.90
A3	15.65	16.05
A4	16.35 REF	
b	0.95	1.05
D	54.80	55.20
D1	65.60	66.20
E	32.20	32.80
P	4.20	4.40
P1	8.90	9.10

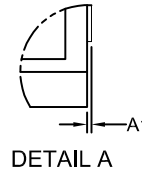
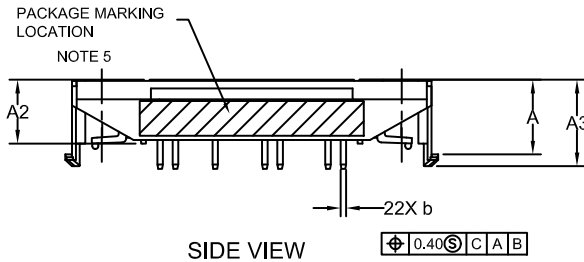

NOTE 4

PIN	PIN POSITION		PIN	PIN POSITION	
	X	Y		X	Y
1	16.80	-11.30	11	-16.80	4.20
2	14.00	-11.30	12	-16.80	11.30
3	5.20	-11.30	13	-14.00	11.30
4	2.40	-11.30	14	-6.70	11.30
5	-6.70	-11.30	15	2.40	11.30
6	-14.00	-11.30	16	5.20	11.30
7	-16.80	-11.30	17	14.00	11.30
8	-16.80	-4.20	18	16.80	11.30
9	-16.80	-1.40	19	16.80	3.50
10	-16.80	1.40	20	16.80	-3.10

NOTES:

- DIMENSIONING AND TOLERANCING PER ASME Y14.5M, 2009.
- CONTROLLING DIMENSION: MILLIMETERS
- DIMENSION b APPLIES TO THE PLATED TERMINALS AND IS MEASURED BETWEEN 1.00 AND 3.00 FROM THE TERMINAL TIP.
- POSITION OF THE CENTER OF THE TERMINALS IS DETERMINED FROM DATUM B THE CENTER OF DIMENSION D, X DIRECTION, AND FROM DATUM A, Y DIRECTION. POSITIONAL TOLERANCE, AS NOTED IN DRAWING, APPLIES TO EACH TERMINAL IN BOTH DIRECTIONS.
- PACKAGE MARKING IS LOCATED AS SHOWN ON THE SIDE OPPOSITE THE PACKAGE ORIENTATION FEATURES.

### MOUNTING FOOTPRINT & MARKING DIAGRAM ON PAGE 2

<b>DOCUMENT NUMBER:</b>	<b>98AON98424F</b>	Electronic versions are uncontrolled except when accessed directly from the Document Repository. Printed versions are uncontrolled except when stamped "CONTROLLED COPY" in red.
<b>DESCRIPTION:</b>	<b>PIM20 55X32.5 / Q0PACK (SOLDER PIN)</b>	<b>PAGE 1 OF 2</b>

ON Semiconductor and are trademarks of Semiconductor Components Industries, LLC dba ON Semiconductor or its subsidiaries in the United States and/or other countries. ON Semiconductor reserves the right to make changes without further notice to any products herein. ON Semiconductor makes no warranty, representation or guarantee regarding the suitability of its products for any particular purpose, nor does ON Semiconductor assume any liability arising out of the application or use of any product or circuit, and specifically disclaims any and all liability, including without limitation special, consequential or incidental damages. ON Semiconductor does not convey any license under its patent rights nor the rights of others.

**PIM20, 55x32.5 / Q0PACK**  
**CASE 180AB**  
**ISSUE D**

DATE 21 NOV 2017

**MOUNTING HOLE POSITION**

PIN	PIN POSITION		PIN	PIN POSITION	
	X	Y		X	Y
1	16.80	11.30	11	-16.80	-4.20
2	14.00	11.30	12	-16.80	-11.30
3	5.20	11.30	13	-14.00	-11.30
4	2.40	11.30	14	-6.70	-11.30
5	-6.70	11.30	15	2.40	-11.30
6	-14.00	11.30	16	5.20	-11.30
7	-16.80	11.30	17	14.00	-11.30
8	-16.80	4.20	18	16.80	-11.30
9	-16.80	1.40	19	16.80	-3.50
10	-16.80	-1.40	20	16.80	3.10

FOR PCB  
THICKNESS 1.45-1.80

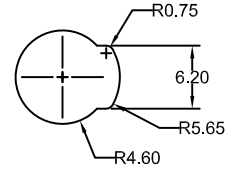

FOR PCB  
THICKNESS 1.80-2.20

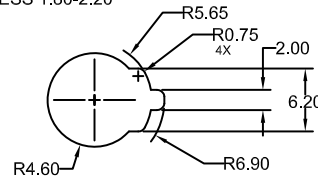

FOR PCB  
THICKNESS 2.20-2.80

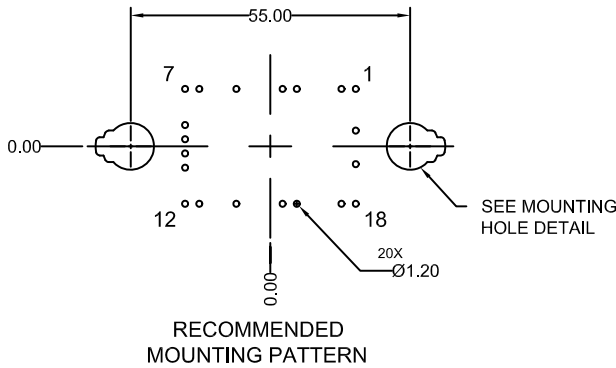
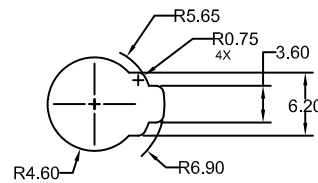

**MOUNTING HOLE DETAIL**

**GENERIC  
MARKING DIAGRAM\***

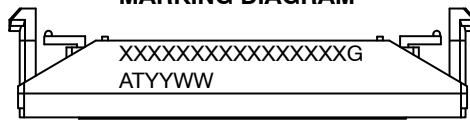

XXXXX = Specific Device Code  
 G = Pb-Free Package  
 AT = Assembly & Test Site Code  
 YYWW = Year and Work Week Code

\*This information is generic. Please refer to device data sheet for actual part marking. Pb-Free indicator, "G" or microdot "▪", may or may not be present. Some products may not follow the Generic Marking.

<b>DOCUMENT NUMBER:</b>	<b>98AON98424F</b>	Electronic versions are uncontrolled except when accessed directly from the Document Repository. Printed versions are uncontrolled except when stamped "CONTROLLED COPY" in red.
<b>DESCRIPTION:</b>	<b>PIM20 55X32.5 / Q0PACK (SOLDER PIN)</b>	<b>PAGE 2 OF 2</b>

ON Semiconductor and are trademarks of Semiconductor Components Industries, LLC dba ON Semiconductor or its subsidiaries in the United States and/or other countries. ON Semiconductor reserves the right to make changes without further notice to any products herein. ON Semiconductor makes no warranty, representation or guarantee regarding the suitability of its products for any particular purpose, nor does ON Semiconductor assume any liability arising out of the application or use of any product or circuit, and specifically disclaims any and all liability, including without limitation special, consequential or incidental damages. ON Semiconductor does not convey any license under its patent rights nor the rights of others.

**onsemi**, **Onsemi**, and other names, marks, and brands are registered and/or common law trademarks of Semiconductor Components Industries, LLC dba "**onsemi**" or its affiliates and/or subsidiaries in the United States and/or other countries. **onsemi** owns the rights to a number of patents, trademarks, copyrights, trade secrets, and other intellectual property. A listing of **onsemi**'s product/patent coverage may be accessed at [www.onsemi.com/site/pdf/Patent-Marking.pdf](http://www.onsemi.com/site/pdf/Patent-Marking.pdf). **onsemi** reserves the right to make changes at any time to any products or information herein, without notice. The information herein is provided "as-is" and **onsemi** makes no warranty, representation or guarantee regarding the accuracy of the information, product features, availability, functionality, or suitability of its products for any particular purpose, nor does **onsemi** assume any liability arising out of the application or use of any product or circuit, and specifically disclaims any and all liability, including without limitation special, consequential or incidental damages. Buyer is responsible for its products and applications using **onsemi** products, including compliance with all laws, regulations and safety requirements or standards, regardless of any support or applications information provided by **onsemi**. "Typical" parameters which may be provided in **onsemi** data sheets and/or specifications can and do vary in different applications and actual performance may vary over time. All operating parameters, including "Typicals" must be validated for each customer application by customer's technical experts. **onsemi** does not convey any license under any of its intellectual property rights nor the rights of others. **onsemi** products are not designed, intended, or authorized for use as a critical component in life support systems or any FDA Class 3 medical devices or medical devices with a same or similar classification in a foreign jurisdiction or any devices intended for implantation in the human body. Should Buyer purchase or use **onsemi** products for any such unintended or unauthorized application, Buyer shall indemnify and hold **onsemi** and its officers, employees, subsidiaries, affiliates, and distributors harmless against all claims, costs, damages, and expenses, and reasonable attorney fees arising out of, directly or indirectly, any claim of personal injury or death associated with such unintended or unauthorized use, even if such claim alleges that **onsemi** was negligent regarding the design or manufacture of the part. **onsemi** is an Equal Opportunity/Affirmative Action Employer. This literature is subject to all applicable copyright laws and is not for resale in any manner.

## ADDITIONAL INFORMATION

### TECHNICAL PUBLICATIONS:

Technical Library: [www.onsemi.com/design/resources/technical-documentation](http://www.onsemi.com/design/resources/technical-documentation)  
onsemi Website: [www.onsemi.com](http://www.onsemi.com)

### ONLINE SUPPORT: [www.onsemi.com/support](http://www.onsemi.com/support)

For additional information, please contact your local Sales Representative at [www.onsemi.com/support/sales](http://www.onsemi.com/support/sales)