

# Automotive Power MOSFET Module

## NXV08B800DT1

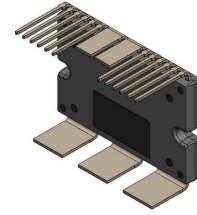

APM17-MDC  
CASE MODHH

### Features

- Back to Back Mosfet Load Switch Module
- Temp Sensing
- Electrically Isolated DBC Substrate for Low Rthjc
- Compact Design for Low Total Module Resistance
- Module Serialization for Full Traceability
- AQG324 Qualified
- UL 94 V-0
- ESD Tested for HBM and CDM per AEC Q101, JS-001, JS-002
- This Device is Pb-Free and is RoHS Compliant

### Applications

- 48 V Battery Switch (Back to Back Source Common)

### Benefits

- Enable Design of Small, Efficient and Reliable System for Reduced Vehicle Fuel Consumption and CO<sub>2</sub> Emission
- Simplified Vehicle Assembly
- Low Thermal Resistance to Junction to Heat Sink by Direct
- Mounting via Thermal Interface Material between Module Case and Heat Sink
- Low Inductance

### MARKING DIAGRAM

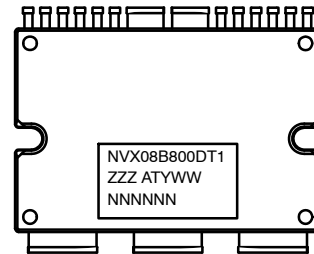

NXV08B800DT1 = Specific Device Code  
ZZZ = Lot ID  
AT = Assembly & Test Location  
Y = Year  
W = Work Week  
NNN = Serial Number

### ORDERING INFORMATION

See detailed ordering and shipping information on page 8 of this data sheet.

# NXV08B800DT1

## Pin Configuration

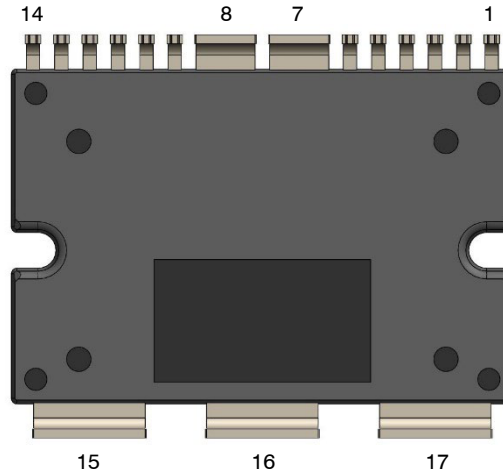

Figure 1. Pin Configuration

## PIN DESCRIPTION

Pin No.	Description	Remark
1	Q2 Gate	
2	Q2 Source Sense	
3	B In #2 Sense	
4	Q4 Gate	
5	Q4 Source Sense	
6	NTC1	
7	B In #2	Use as common or separately per the applications
8	B In #1	
9	NTC2	
10	Q3 Source Sense	
11	Q3 Gate	
12	B In #1 Sense	
13	Q1 Source Sense	
14	Q1 Gate	
15	Common Source 1	For electrical test purpose for module
16	B Out	
17	Common Source 2	For electrical test purpose for module

# NXV08B800DT1

## Block Diagram

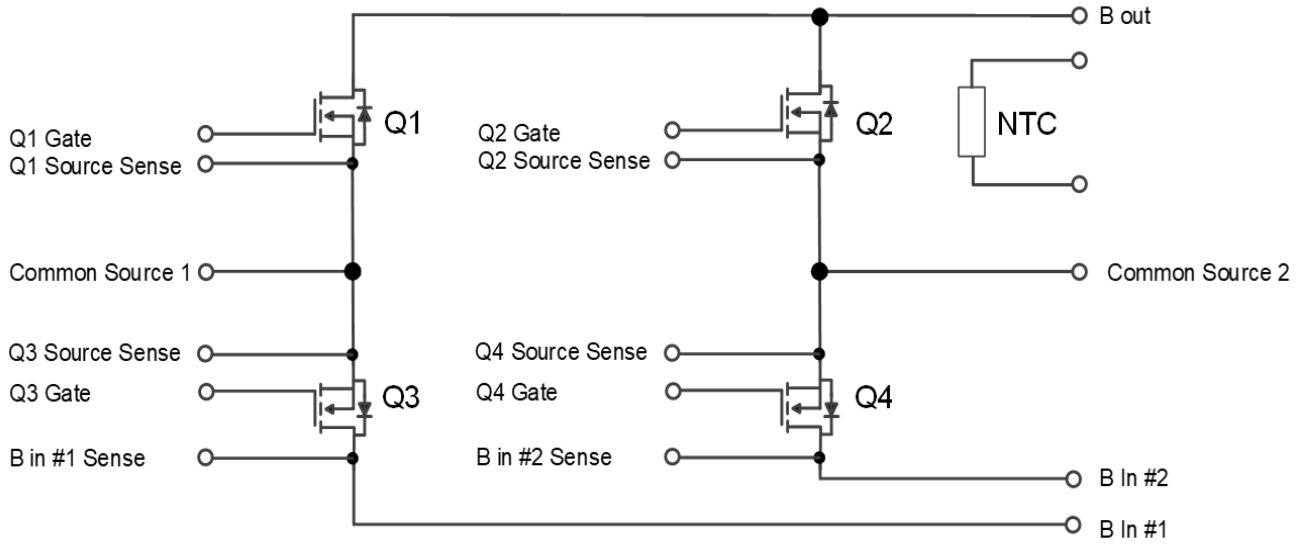

**Figure 2. Block Diagram**

### Flammability Information Solder

All materials present in the power module meet UL flammability rating class 94V-0.

### Compliance to RoHS Directives

The power module is 100% lead free and RoHS compliant 2000/53/C directive.

### Solder

Solder used is a lead free SnAgCu alloy. Base of the leads, at the interface with the package body should not be exposed to more than 200°C during mounting on the PCB, this to prevent the remelt of the solder joints.

### ABSOLUTE MAXIMUM RATINGS (T<sub>J</sub> = 25°C unless otherwise noted)

Symbol	Parameter	Max	Unit
VDS(Q1~Q4)	Drain to Source Voltage	80	V
VGS(Q1~Q4)	Gate to Source Voltage	±20	V
EAS(Q1~Q4)	Single Pulse Avalanche Energy (Note 1)	2,445	mJ
T <sub>J</sub>	Maximum Junction Temperature	175	°C
T <sub>STG</sub>	Storage Temperature	125	°C

Stresses exceeding those listed in the Maximum Ratings table may damage the device. If any of these limits are exceeded, device functionality should not be assumed, damage may occur and reliability may be affected.

- Starting T<sub>J</sub> = 25°C, L = 0.47 mH, I<sub>AS</sub> = 102 A, V<sub>DD</sub> = 72 V during inductor charging and V<sub>DD</sub> = 0 V during time in avalanche.

# NXV08B800DT1

## ELECTRICAL CHARACTERISTICS (T<sub>J</sub> = 25°C unless otherwise noted)

Symbol	Parameter	Test Condition	Min	Typ	Max	Unit
BVDSS	Drain-to-Source Breakdown Voltage	I <sub>D</sub> = 1 mA, V <sub>GS</sub> = 0 V	80	–	–	
VGS(th)	Gate to Source Threshold Voltage	V <sub>GS</sub> = V <sub>DS</sub> , I <sub>D</sub> = 1 mA	2	–	4.6	V
VSD	Source-to-Drain Diode Voltage	I <sub>SD</sub> = 160 A, V <sub>GS</sub> = 0 V	–	0.79	1.1	V
Measured RDS(ON) Q1, Q2	Single Q1, Q2 MOSFET (Note 2)	V <sub>GS</sub> = 12 V, I <sub>D</sub> = 160 A, T <sub>J</sub> = 25°C	–	0.71	0.81	mΩ
Measured RDS(ON) Q3, Q4	Single Q3, Q4 MOSFET (Note 2)	V <sub>GS</sub> = 12 V, I <sub>D</sub> = 160 A, T <sub>J</sub> = 25°C	–	0.50	0.595	mΩ
Pure FET RDS(ON) Q1, Q2, Q3, Q4	Rdson Measurement with Kelvin Pin with Min Impact of Measurement Path (Note 2)	V <sub>GS</sub> = 12 V, I <sub>D</sub> = 160 A, T <sub>J</sub> = 25°C	–	0.46	–	mΩ
IGSS	Gate-to-Source Leakage Current	V <sub>GS</sub> = ±20 V, V <sub>DS</sub> = 0 V, T <sub>J</sub> = 25°C	–100	–	+100	nA
IDSS	Drain-to-Source Leakage Current	V <sub>DS</sub> = 80 V, V <sub>GS</sub> = 0 V, T <sub>J</sub> = 25°C	–	–	2	μA

Product parametric performance is indicated in the Electrical Characteristics for the listed test conditions, unless otherwise noted. Product performance may not be indicated by the Electrical Characteristics if operated under different conditions.

- All bare die MOSFETs have same die size and same level of Rdson value. However the different Rdson values listed in the datasheet are due to the different access points available inside the module for Rdson measurement. In this reason, the actual FET RDS(ON) is not able to be measured. For the Pure FET Rdson for power loss calculation, the Rdson measurement with Kelvin pin from NXV08H400XT1 can be used. Each Rdson measurement paths are as below table, "Resistance Measurement Methods"

## RESISTANCE MEASUREMENTS METHODS

	+ Force Pin#	– Force Pin#	+ Sense Pin#	– Sense Pin#
FET Rdson Q1	16	15	16	13
FET Rdson Q2	16	17	16	2
FET Rdson Q3	8	15	12	10
FET Rdson Q4	7	17	3	5

## TEMPERATURE SENSE (NTC THERMISTOR)

Parameter	Min	Typ	Max	Unit
Voltage	7.5	–	12	V

## THERMAL RESISTOR

Parameter	Min	Typ	Max	Unit
Rthjc: Thermal Resistance Junction to Case, Single Inverter FET	–	–	0.46	°C/W

## ISOLATION VOLTAGE (Isolation voltage between the Base plate and to control pins or power terminals.)

Test	Test Condition	Test Time	Min	Max	Unit
Leakage @ Isolation Voltage (Hi-Pot)	VAC = 3 kV	Time = 1 s	–	250	μA

# NXV08B800DT1

## DYNAMIC AND SWITCHING CHARACTERISTICS (T<sub>J</sub> = 25°C unless otherwise noted)

Symbol	Parameter	Condition	Min	Typ	Max	Unit
--------	-----------	-----------	-----	-----	-----	------

### DYNAMIC CHARACTERISTICS

C <sub>iss</sub>	Input Capacitance	V <sub>DS</sub> = 40 V, V <sub>GS</sub> = 0 V, f = 750 kHz	–	30,150	–	pF
C <sub>oss</sub>	Output Capacitance		–	4,505	–	pF
C <sub>rss</sub>	Reverse Transfer Capacitance		–	77	–	pF
R <sub>g</sub>	Gate Resistance	f = 750 kHz	–	4.3	–	Ω
Q <sub>g(tot)</sub>	Total Gate Charge	V <sub>GS</sub> = 0 to 12 V, I <sub>D</sub> = 160 A	–	502	–	nC
Q <sub>gs</sub>	Gate to Source Gate Charge		–	193	–	nC
Q <sub>gd</sub>	Gate to Drain “Miller” Charge		–	89	–	nC

### SWITCHING CHARACTERISTICS

t <sub>on</sub>	Turn-On Time	V <sub>DD</sub> = 48 V, I <sub>D</sub> = 400 A V <sub>GS</sub> = 12 V, R <sub>G(on/off)</sub> = 15/15	–	710	–	ns
t <sub>d(on)</sub>	Turn-On Delay Time		–	235	–	ns
t <sub>r</sub>	Turn-On Rise Time		–	475	–	ns
t <sub>d(off)</sub>	Turn-Off Delay Time		–	608	–	ns
t <sub>f</sub>	Turn-Off Fall Time		–	290	–	ns
t <sub>off</sub>	Turn-Off Time		–	898	–	ns

### DRAIN-SOURCE DIODE CHARACTERISTICS

t <sub>RR</sub>	Reverse Recovery Time	V <sub>DD</sub> = 48 V, I <sub>D</sub> = 400 A V <sub>GS</sub> = 12 V, R <sub>G(on/off)</sub> = 15/15	–	59	–	ns
Q <sub>RR</sub>	Reverse Recovery Charge		–	1433	–	nC

3. Dynamic & Switching characteristics data is by characterization test result and guaranteed by design factors.

### COMPONENTS

Component	Description	Type	Qty.	Specification
MOSFET	Bare Die	Bare Die	4	80 V 0.55 m
NTC	10 k ±1% 1,600 x 800 μm	Discrete	1	B-Constant @ 25/50°C : 3380K @ 25/85°C : 3434K @ 25/100°C : 3455K

TYPICAL CHARACTERISTICS

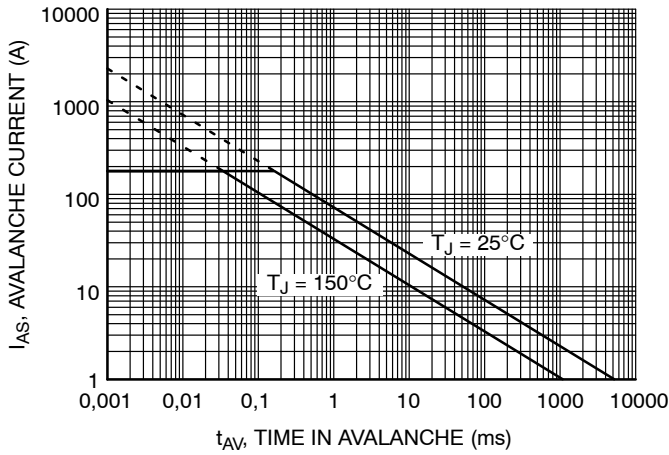

Figure 3. Unclamped Inductive Switching Capability

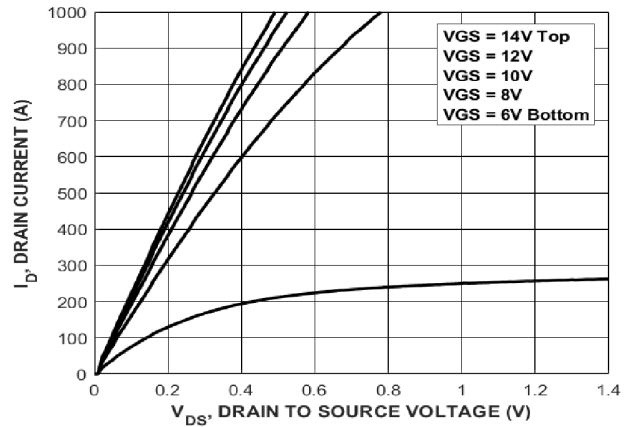

Figure 4. Saturation Characteristics

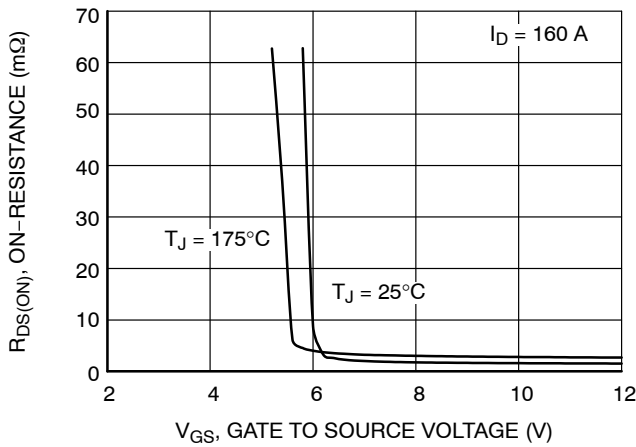

Figure 5.  $R_{DS(on)}$  vs. Gate Voltage

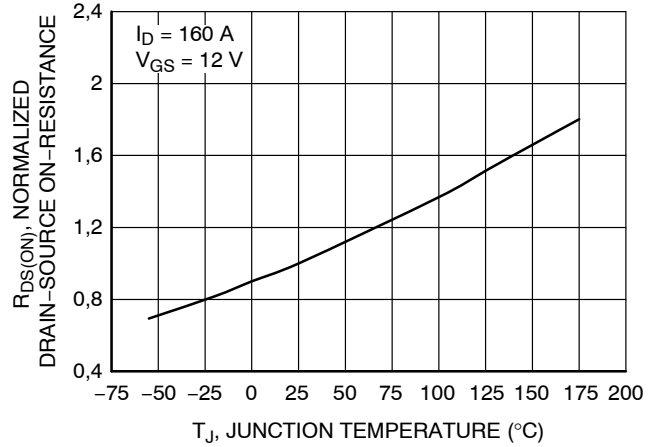

Figure 6.  $R_{DS(on)}$  vs. Temperature

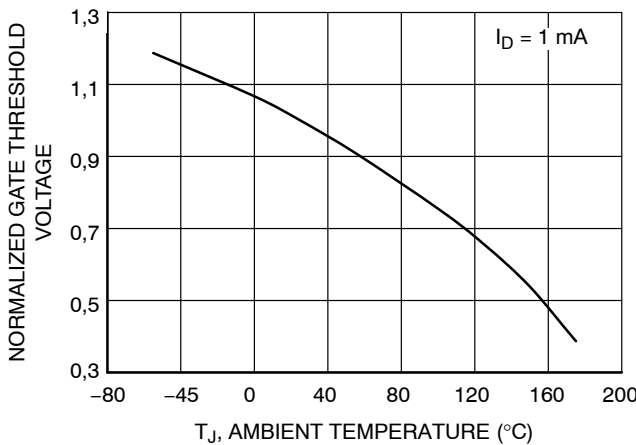

Figure 7. Normalized Gate Threshold Voltage vs. Temperature

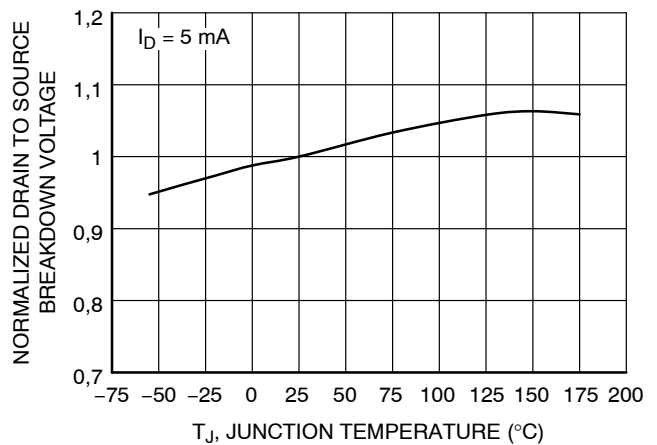

Figure 8. Normalized Drain to Source Breakdown Voltage vs. Junction Temperature

# NXV08B800DT1

## TYPICAL CHARACTERISTICS (continued)

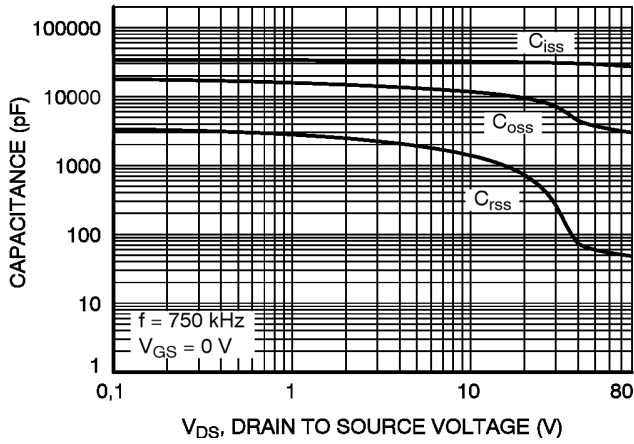

Figure 9. Capacitance vs. Drain to Source Voltage

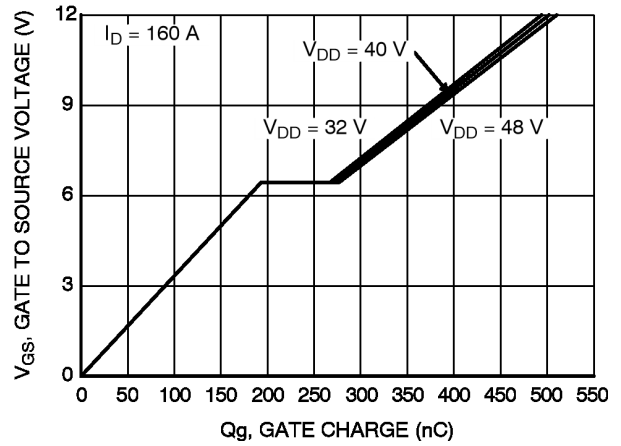

Figure 10. Gate Charge vs. Drain to Source Voltage

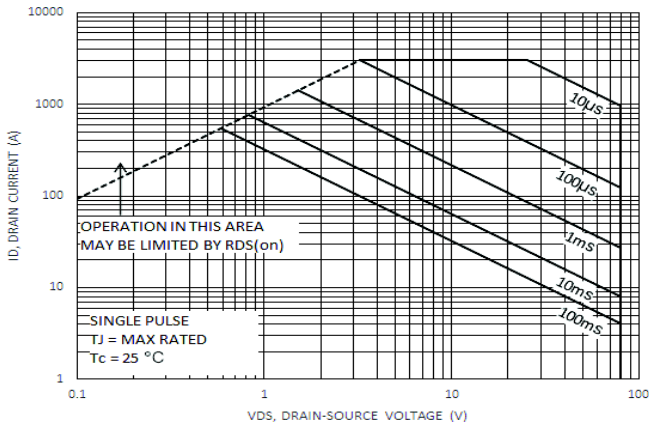

Figure 11. Safe Operating Area

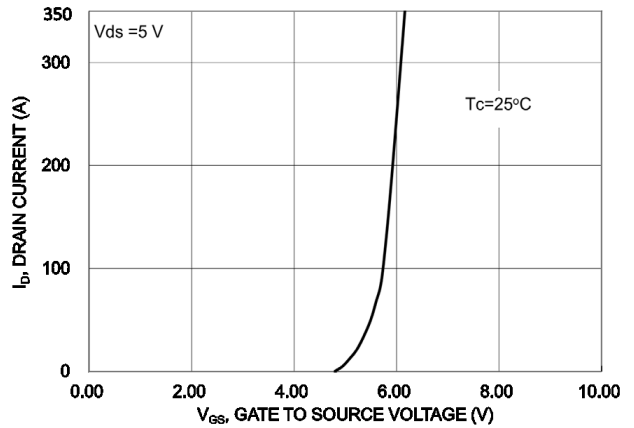

Figure 12. Transfer Characteristics

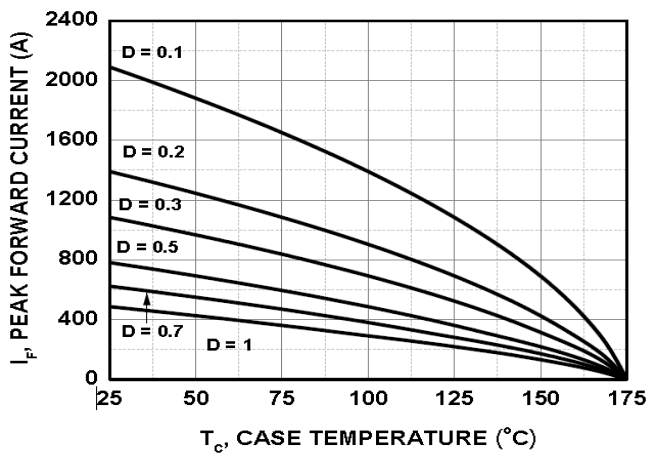
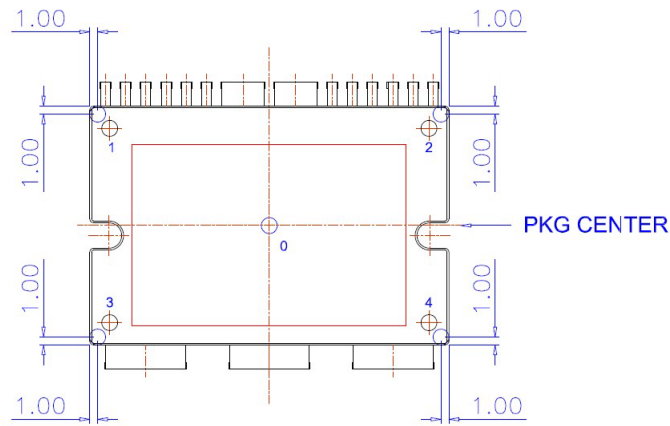

Figure 13. Body Diode Current

# NXV08B800DT1



20  
 FLATNESS : MAX. 150um  
 - MEASURING AT INDICATING POINTS  
 1, 2, 3, AND 4 (BASED ON "0")

**Figure 14. Flatness Measurement Position**

## MECHANICAL CHARACTERISTICS AND RATINGS

Parameter	Test Conditions	Min	Typ	Max	Units
Device Flatness	Refer to the package dimensions	0	-	150	μm
Mounting Torque	Mounting screw: M3, recommended 0.7 N·m	0.4	-	1.4 (Note 4)	N·m
Weight		-	23.7	-	g

4. Max Torque rating can be different by the type of screw, such as the screw head diameter, use or without use of Washer. In case of special screw mounting method is applied, contact to **onsemi** for the proper information of mounding condition.

## ORDERING INFORMATION

Part Number	Package	Pb-Free and RoHS Compliant	Operating Ambient Temperature Range	Packing Method
NXV08B800DT1	APM17-MDC	yes	-40~125°C	Tube



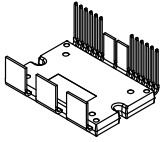

APM17-MDC  
CASE MODHH  
ISSUE C

DATE 08 DEC 2021

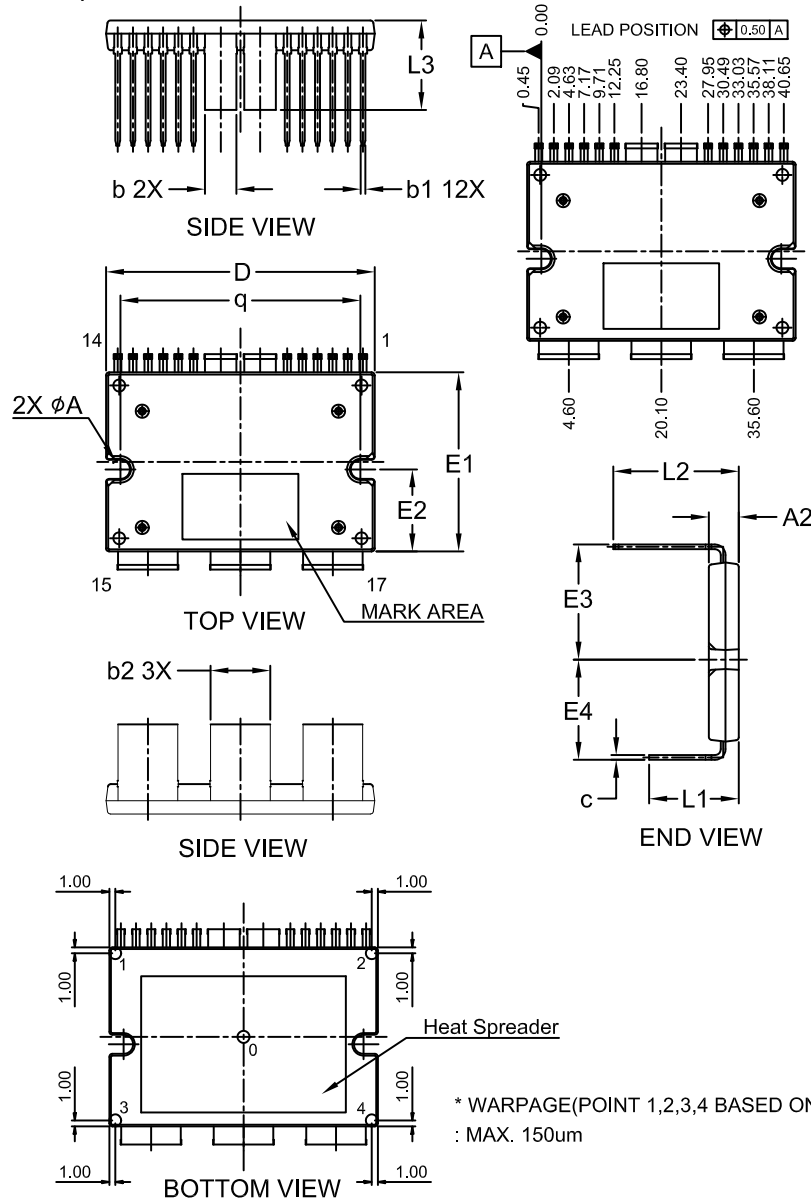

NOTES:

1. DIMENSIONING AND TOLERANCING PER ASME Y14.5M, 2009.
2. CONTROLLING DIMENSION: MILLIMETERS
3. DIMENSIONS ARE EXCLUSIVE OF BURRS, MOLD FLASH AND TIE BAR EXTRUSIONS.

DIM	MILLIMETERS		
	MIN.	NOM.	MAX.
A2	4.90	5.00	5.10
b	5.20	5.30	5.40
b1	0.70	0.80	0.90
b2	9.90	10.00	10.10
c	0.75	0.80	0.90
D	44.90	45.00	45.10
E1	29.90	30.00	30.10
E2	13.65	13.75	13.85
E3	19.00	19.30	19.60
E4	16.50	16.80	17.10
L1	14.70	15.00	15.30
L2	20.70	21.00	21.30
L3	14.70	15.00	15.30
q	40.10	40.20	40.30
$\phi A$	3.10	3.20	3.30

GENERIC  
MARKING DIAGRAM\*

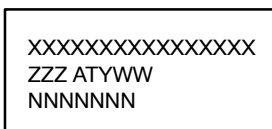

XXXX = Specific Device Code  
 ZZZ = Lot ID  
 AT = Assembly & Test Location  
 Y = Year  
 W = Work Week  
 NNN = Serial Number

\*This information is generic. Please refer to device data sheet for actual part marking. Pb-Free indicator, "G" or microdot "μ", may or may not be present. Some products may not follow the Generic Marking.

<b>DOCUMENT NUMBER:</b>	<b>98AON28701H</b>	Electronic versions are uncontrolled except when accessed directly from the Document Repository. Printed versions are uncontrolled except when stamped "CONTROLLED COPY" in red.
<b>DESCRIPTION:</b>	<b>APM17-MDC</b>	<b>PAGE 1 OF 1</b>

onsemi and ONSEMI are trademarks of Semiconductor Components Industries, LLC dba onsemi or its subsidiaries in the United States and/or other countries. onsemi reserves the right to make changes without further notice to any products herein. onsemi makes no warranty, representation or guarantee regarding the suitability of its products for any particular purpose, nor does onsemi assume any liability arising out of the application or use of any product or circuit, and specifically disclaims any and all liability, including without limitation special, consequential or incidental damages. onsemi does not convey any license under its patent rights nor the rights of others.

**onsemi**, **Onsemi**, and other names, marks, and brands are registered and/or common law trademarks of Semiconductor Components Industries, LLC dba "**onsemi**" or its affiliates and/or subsidiaries in the United States and/or other countries. **onsemi** owns the rights to a number of patents, trademarks, copyrights, trade secrets, and other intellectual property. A listing of **onsemi**'s product/patent coverage may be accessed at [www.onsemi.com/site/pdf/Patent-Marking.pdf](http://www.onsemi.com/site/pdf/Patent-Marking.pdf). **onsemi** reserves the right to make changes at any time to any products or information herein, without notice. The information herein is provided "as-is" and **onsemi** makes no warranty, representation or guarantee regarding the accuracy of the information, product features, availability, functionality, or suitability of its products for any particular purpose, nor does **onsemi** assume any liability arising out of the application or use of any product or circuit, and specifically disclaims any and all liability, including without limitation special, consequential or incidental damages. Buyer is responsible for its products and applications using **onsemi** products, including compliance with all laws, regulations and safety requirements or standards, regardless of any support or applications information provided by **onsemi**. "Typical" parameters which may be provided in **onsemi** data sheets and/or specifications can and do vary in different applications and actual performance may vary over time. All operating parameters, including "Typicals" must be validated for each customer application by customer's technical experts. **onsemi** does not convey any license under any of its intellectual property rights nor the rights of others. **onsemi** products are not designed, intended, or authorized for use as a critical component in life support systems or any FDA Class 3 medical devices or medical devices with a same or similar classification in a foreign jurisdiction or any devices intended for implantation in the human body. Should Buyer purchase or use **onsemi** products for any such unintended or unauthorized application, Buyer shall indemnify and hold **onsemi** and its officers, employees, subsidiaries, affiliates, and distributors harmless against all claims, costs, damages, and expenses, and reasonable attorney fees arising out of, directly or indirectly, any claim of personal injury or death associated with such unintended or unauthorized use, even if such claim alleges that **onsemi** was negligent regarding the design or manufacture of the part. **onsemi** is an Equal Opportunity/Affirmative Action Employer. This literature is subject to all applicable copyright laws and is not for resale in any manner.

## ADDITIONAL INFORMATION

### TECHNICAL PUBLICATIONS:

Technical Library: [www.onsemi.com/design/resources/technical-documentation](http://www.onsemi.com/design/resources/technical-documentation)  
onsemi Website: [www.onsemi.com](http://www.onsemi.com)

### ONLINE SUPPORT: [www.onsemi.com/support](http://www.onsemi.com/support)

For additional information, please contact your local Sales Representative at [www.onsemi.com/support/sales](http://www.onsemi.com/support/sales)