

# FUSB307B Type-C Port Controller IC Evaluation Board User's Manual

## FUSB307BGEVB

This user guide supports the evaluation kit for the FUSB307B. It should be used in conjunction with the FUSB307B data sheets as well as onsemi's application notes and technical support team. Please visit onsemi's website at [www.onsemi.com](http://www.onsemi.com).

### INTRODUCTION

The FUSB307B evaluation board and included software allows customers a complete platform to evaluate the Type-C interface detection solution the FUSB307B provides. The evaluation board is designed for both stand-alone operation and connection to test equipment for specific testing requirements. The FUSB307B software provides both fully automatic control and manual control of the FUSB307B functions. With a single connection to a PC and a couple configurations in the GUI, the evaluation board can function as a Source, Sink, or Dual Role port.

### Description

The FUSB307B targets system designers looking to implement up to four USB Type-C<sup>®</sup> port controllers (TCPC) with USB-PD capabilities.

This solution provides integrated Type-C Rev 1.3 detection circuitry enabling manual attach/detach detection. Time critical Power Delivery functionality is handled autonomously, offloading the  $\mu$ Processor or Type-C Port Manager (TCPM).

The FUSB307B complies with the USB-PD Interface Specification.

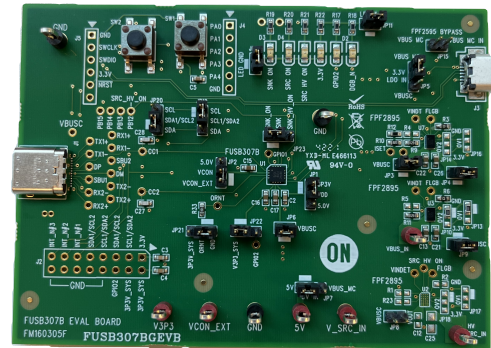

Figure 1. FUSB307B Evaluation Board

### Features

- USB-PD Interface Spec Rev 1.0 Ver. 1.2 Compatible
- USB Type-C Rev 1.3 Compatible
- USB-PD Rev 3.0 Ver. 1.1 Compatible
- Fast Role Swap
- Sink Transmit
- Extended Data Messages (Chunked)
- Dual-Role Functionality
  - ◆ Manual Type-C Detection
  - ◆ Automatic DRP Toggling
- USB-PD Interface Specification Support
  - ◆ Automatic GoodCRC Packet Response
  - ◆ Automatic Retries of Sending Packet
  - ◆ All SOP\* Types Supported
- VBUS Source and Sink Control
- Integrated 3 W Capable VCONN to CCx Switch
- 10-bit VBUS ADC
- Programmable GPIOs
- 4 Selectable I<sup>2</sup>C Addresses
- Dead Battery Operation
  - ◆ Powered from VBUS
  - ◆ LDO Output provides power to TCPM
- Packaging
  - ◆ 16-pin WQFN (3.0 × 3.0 mm)

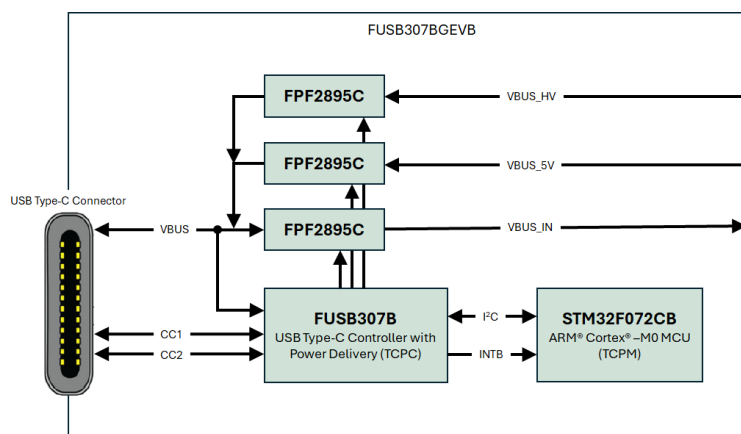

Figure 2. Block Diagram

# FUSB307BGEVB

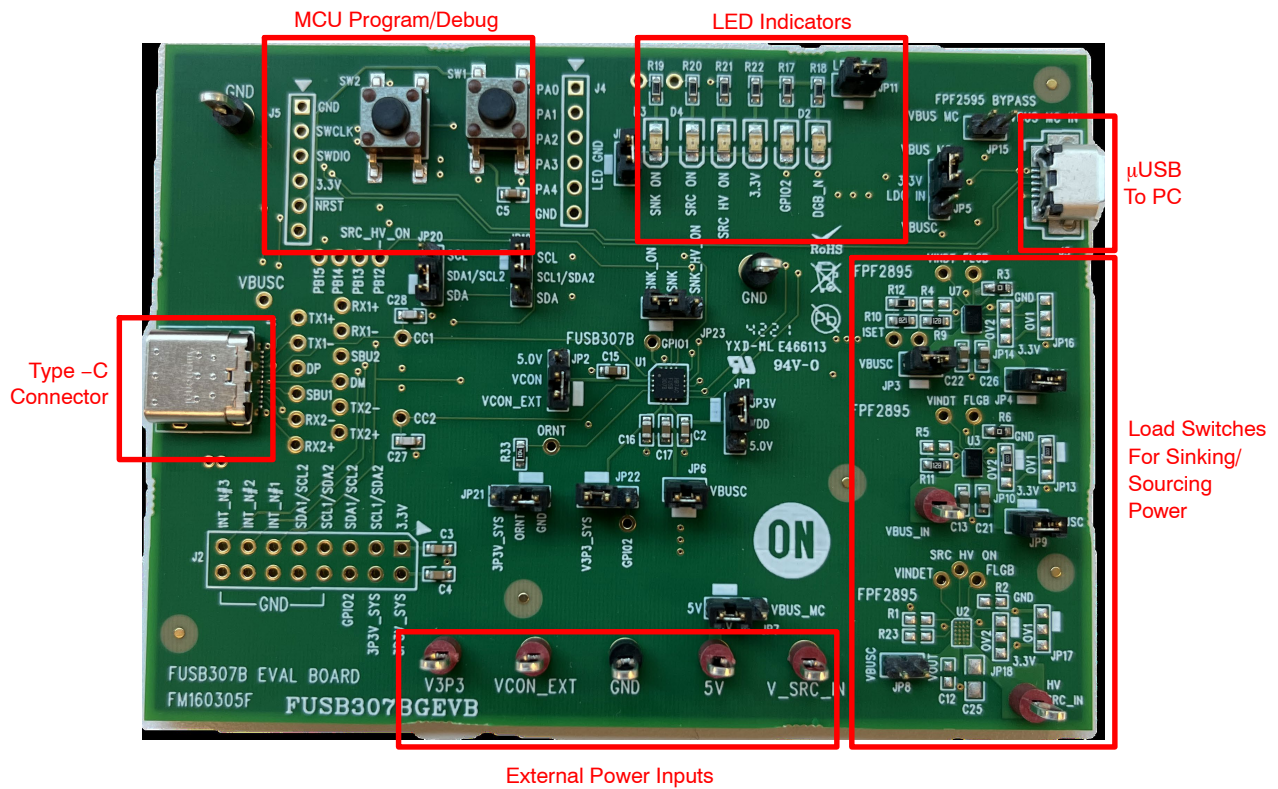

Figure 3. Evaluation Board Layout

## POWER CONFIGURATION

The FUSB307B evaluation board is designed to be able to be powered from just the PC connection or powered externally based on the testing requirements. To use the external VDD to the device, take the jumper off of JP1 and connect external VDD to the middle post of JP1, which is FUSB307B VDD.

### Power Supplied from Board

The FUSB307B can fully operate from the VBUS input of the micro-B USB receptacle J3. To operate the evaluation board, the USB power should be provided to the board over the micro-B USB. Then, the on board regulator (LDO) generates VDD, which is 3.3 V for device supply. Once valid USB power is provided, the indicator LED, 3.3 V, is turned on.

## I<sup>2</sup>C Connection

### Direct I<sup>2</sup>C Connection

Customers that want to directly connect their I<sup>2</sup>C masters to the evaluation board can connect the I<sup>2</sup>C master signals to the SCL, SDA, and INT\_N test points.

### PC I<sup>2</sup>C Connection

The evaluation board uses an STM32F072CB micro-controller-unit (mcu) as an I<sup>2</sup>C master to control the FUSB307B. This is the communication method used by the FUSB307B GUI. By connecting the PC to the micro-B USB receptacle J3, the evaluation board automatically powers the microcontroller and connects the I<sup>2</sup>C master to the FUSB307B.

# FUSB307BGEVB

## TYPE-C SIGNAL CONNECTIONS

The FUSB307B evaluation board allows different ways of connecting to another Type-C device or controlling the signals of the Type-C receptacle based on the type of testing that is required.

### CC Pins

The Type-C CC1 and CC2 pins are directly connected to the Type-C receptacle J1 on the board. Note that the FUSB307B evaluation board contains the minimum cReceiver capacitance specified in the USB PD specification for the CC pins which is 220 pF. This capacitance is C27 and C28 in the schematic.

### VBUS 5 V

VBUS is used differently based on the Type-C port type. The FUSB307B controls an integrated load switch (FPF2895C) for Sink and Source path depending on what device is connected. In each case, an LED indicator (SNK ON and SRC ON) tells which VBUS power path is established. A test point for VBUS voltage sensing (VBUS\_S on the schematic, VBUSC on the EVB) is located near J1. The EVB is designed to supply 5.0 V VBUS from PC USB power or an external supply. This option can be configurable by JP7 as shown below.

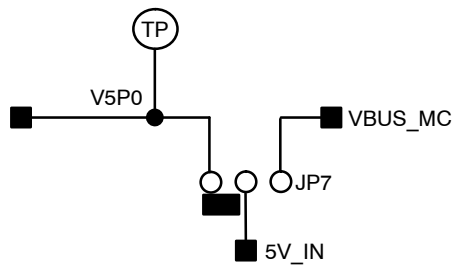

Figure 4. 5V\_IN Power Selection

- Jumper on VBUS\_MC: PC USB power to 5V\_IN
- Jumper off: external power (V\_SRC\_IN test point) to 5V\_IN thru JP4
- Jumper on 5 V: external power (5 V test point) to 5V\_IN

### VBUS Greater Than 5 V Option

The "FM160305F" version of the FUSB307BGEVB does not have the higher voltage source VBUS option installed. To offer VBUS greater than 5 V, the HV\_SRC\_IN test point can be used as an input for a VBUS level of 9 V, 12 V, 15 V, or 20 V. This input is controlled by the FPF2895C load switch and the SRV\_HV\_ON signal from the mcu. To enable this option, the following modifications need to be made to the EVB:

- Populate the empty U2 footprint with an FPF2895CUCX device

- Short both JP17 and JP18 to GND (for 23 V over voltage protection)
- Short JP8 (connecting to Type-C VBUS)
- Populate R23 with 1.3 kΩ resistor (for approx 3.4 A VBUS overcurrent limit)
- Populate C12 with a 1 μF capacitor
- Populate C25 with a 10 μF capacitor
- Provide 9 V, 12 V, 15 V, or 20 V at the HV\_SRC\_IN test point at the bottom right corner of the EVB

### VCONN

VCONN can be supplied to the FUSB307B externally through the VCONN test point found along the External Power Inputs test points.

### USB2.0 and SBU

They are left open in the Type-C connector with no connections to other circuitry on the board. Test points are near the Type-C connector J1.

### STATUS LED'S

The following status LEDs are provided on the evaluation board. All of the LEDs can be disconnected by JP11 and JP12.

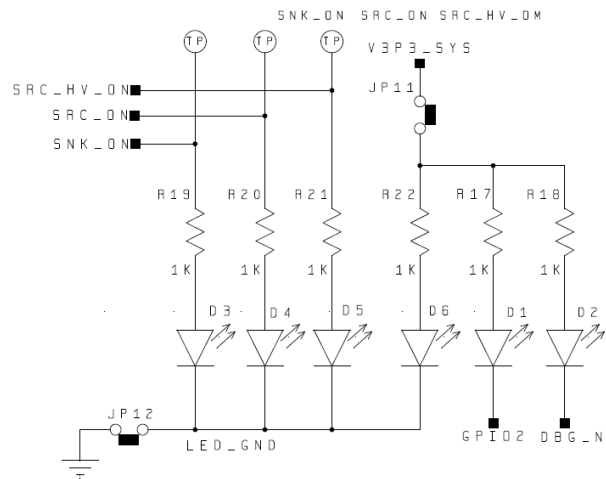

Figure 5. LED Indicators

Table 1. STATUS LED'S

LED	Status
D1	on when GPIO2 is active (low)
D2	on when DBG_N is in active (low)
D3	on when SNK_ON is active (high)
D4	on when SRC_ON is active (high)
D5	on when SRC_HV_ON is active (high)
D6	on when V3P3_SYS is present (high)

# FUSB307BGEVB

## SCHEMATIC

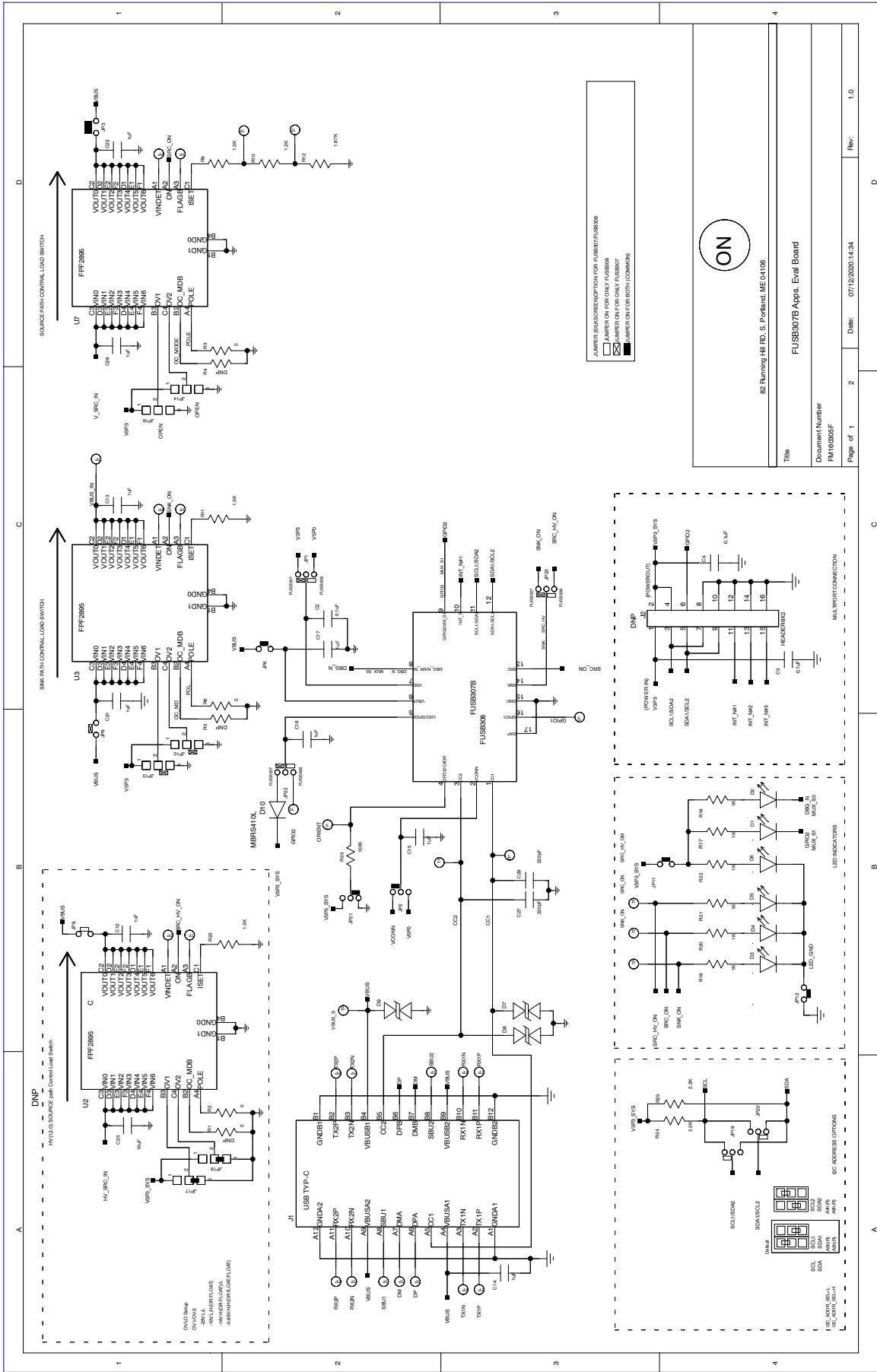

ON

82 Blumling HE RD, S. Portland, ME 04106	
Title	FUSB307B Apps. Eval Board
Document Number	RM160305F
Page of 1	2
Date:	07/12/2020-14:34
Rev:	1.0

Figure 6. FUSB307B Evaluation Board FM160305D Schematic (1/2)

# FUSB307BGEVB

## SCHEMATIC

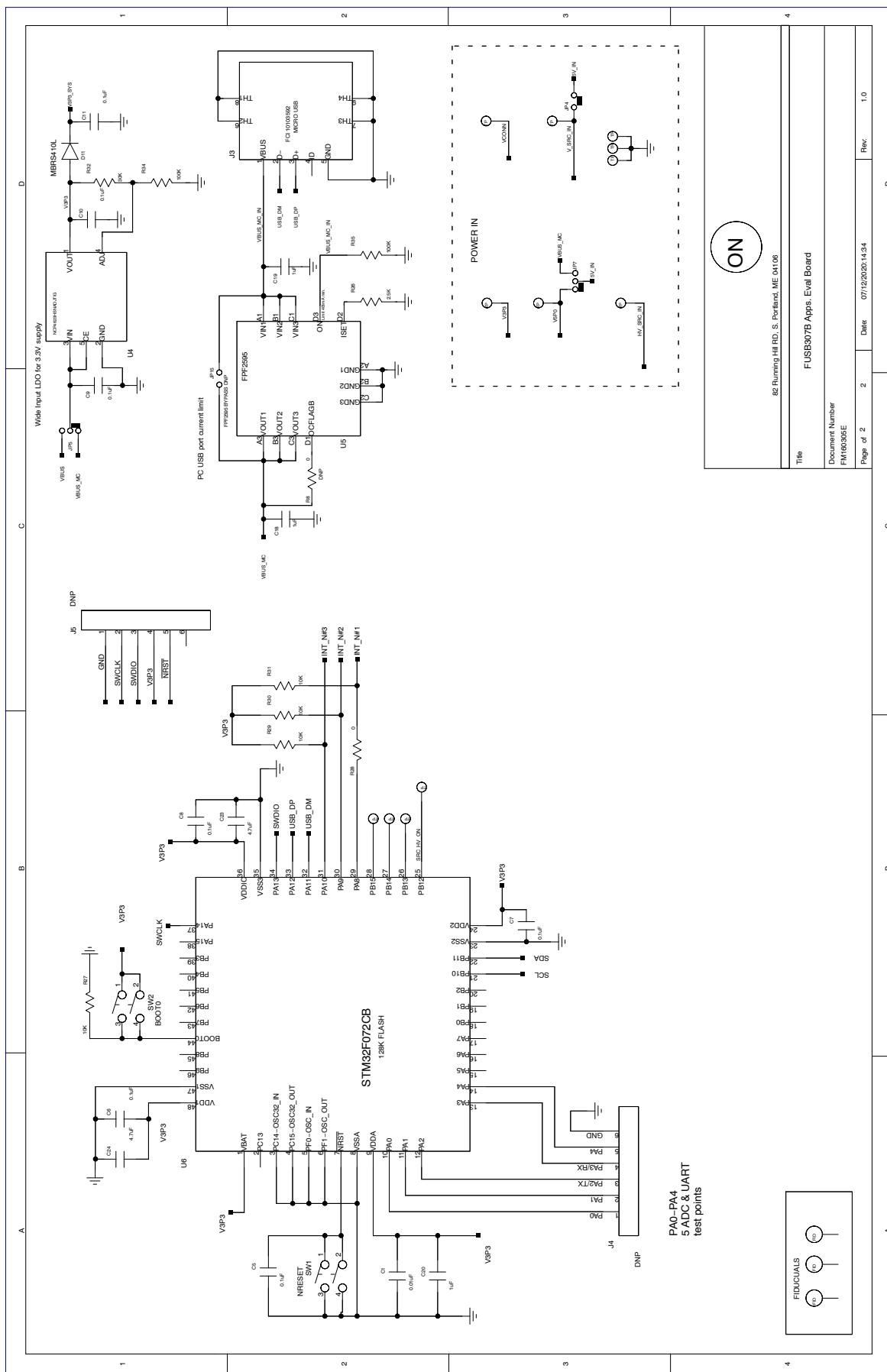

ON

82 Running Hill Rd., S. Portland, ME 04106  
 Title FUSB307B Apps. Eval Board  
 Document Number FM160305E  
 Page of 2 2 Date 07/12/2005 14:34 Rev. 1.0

Figure 7. FUSB307B Evaluation Board FM160305D Schematic (2/2)

# FUSB307BGEVB

## FUSB307B EVALUATION PLATFORM GUI CONFIGURATION

### GUI Installation

Instructions for installing *onsemi* FUSB307B Control Software

1. Locate and extract the file “FUSB307B\_gui\_1\_1\_0\_Customer.exe” (versions of the file will include the release number) from the archive file “FUSB307B\_gui\_1\_1\_0\_Customer.7z”. The .exe can be located in any location you prefer. Double-click the .exe file to start the GUI.
2. Plug the STD–A end of the USB Cable into the USB port of your PC.
3. Plug the Micro–B end of the USB Cable into the GUI Interface (J3 at the top right corner of the board) on the Evaluation Board. V3P3\_SYS LED will illuminate if properly connected.
4. Wait for the USB Port to connect with a message in the lower left hand corner of the GUI that states “USB Device: VID:0x1057 PID:0x0133” and “Device Connected v1.1.1” in the lower right corner (or a newer version if applicable). If the message states “Disconnected”, then there is a connection problem.

*Upgrading the GUI Software:*

1. Simply delete the previous version of the .exe.
2. Repeat the installation process above.

## GUI OPERATION

### Program Startup

To operate the FUSB307B Evaluation Platform, perform the following steps:

1. Install the FUSB307B GUI software as described in the previous section.
2. Connect the FUSB307B board to your computer with a micro-USB cable.
3. Start the GUI software by double-clicking the .exe file from the location you saved it to.
4. The base operation GUI will appear as shown in Figure 8 below.
5. The lower right part of the screen will now indicate “Device Connected v1.1.1” (the version number may be different as newer firmware is released). If this is not shown, there is a likely a power configuration issue with the FUSB307B device. If power is supplied correctly, check that the firmware was programmed correctly. The document for firmware download is posted separately. You can now read, write, and configure the FUSB307B. Accessories can be plugged in and used.

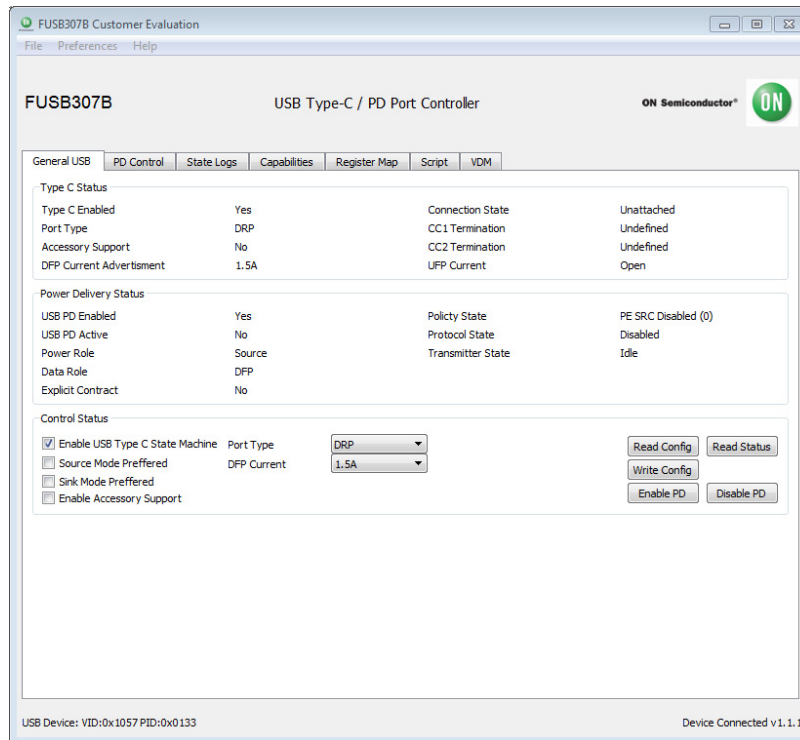

Figure 8. Initial Page of FUSB307B GUI

# FUSB307BGEVB

## USING THE GUI

There are two basic modes to control/monitor the FUSB307B. Pre-programmed firmware on the mcu can control the FUSB307B and then the GUI can work with the firmware to control/monitor the FUSB307B. The GUI can also be used with the Register Map and Script tabs to manually control/monitor the FUSB307B.

These two modes should not be used together, as it will interfere with the autonomous mode state machine. By default, the USB Type-C state machine is enabled. The checkbox has to be de-selected to use the device manually.

Status information is shown in the top half of the window, as well as in the “PD Control” tab and the “State Logs” tab. Scripts can also be loaded in the “Script” tab for easier loading of multiple sequential steps.

More information on specific operation of each section of the GUI is provided in the following sections.

## File Menu

- “File”
  - ◆ Click “Exit” to exit the FUSB307B GUI program
- “Preferences”
  - ◆ Select “Auto Poll” to automatically update the GUI with the FUSB307B status
- “Help”
  - ◆ “About” provides GUI version information

## General

This tab provides the overall device status. The lower third of this tab is the “Control” section. When the FUSB307B EVB is initially connected to the PC, this section will automatically update itself. At any time after that, the “Read Config” button should be used before making any changes to this section. The port type can be set to either DRP, Sink, or Source, and other features can be enabled or disabled here. After making any changes, press “Write Config” to update the device with any changes.

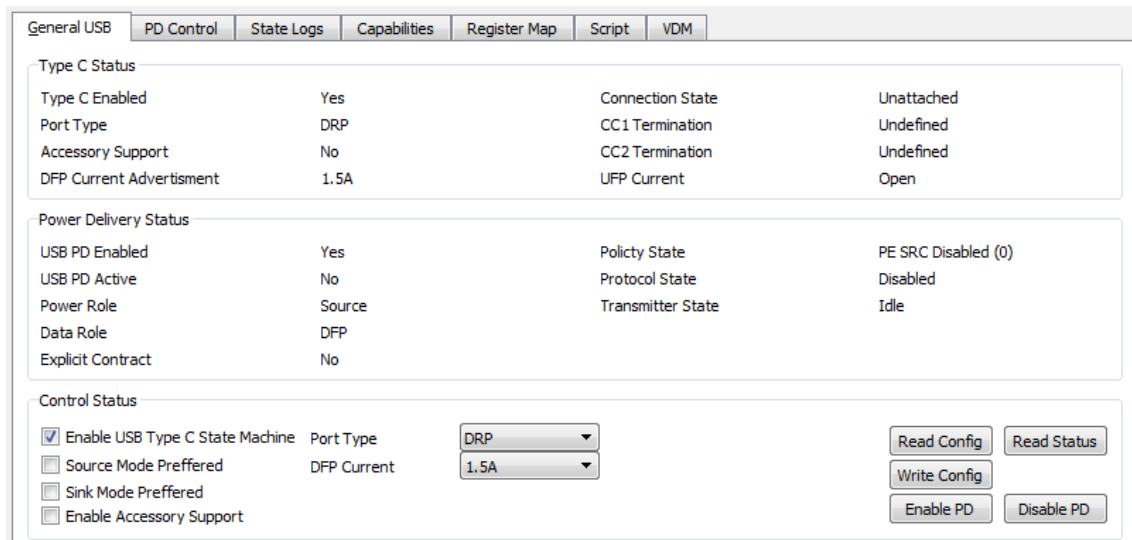

Figure 9. General Tab

# FUSB307BGEVB

## PD Control

This tab logs any PD activity with PD Message History Box. The log file can be expanded or collapsed to show more or less detail of the PD packets. The other control boxes indicate the current state of the PD state machine and what

contract was negotiated. When connected as a sink, it displays the source capabilities of the source that is attached. The user can select different capabilities and make the requests. The user can also manually send different PD messages through the pull-down menu and the click buttons.

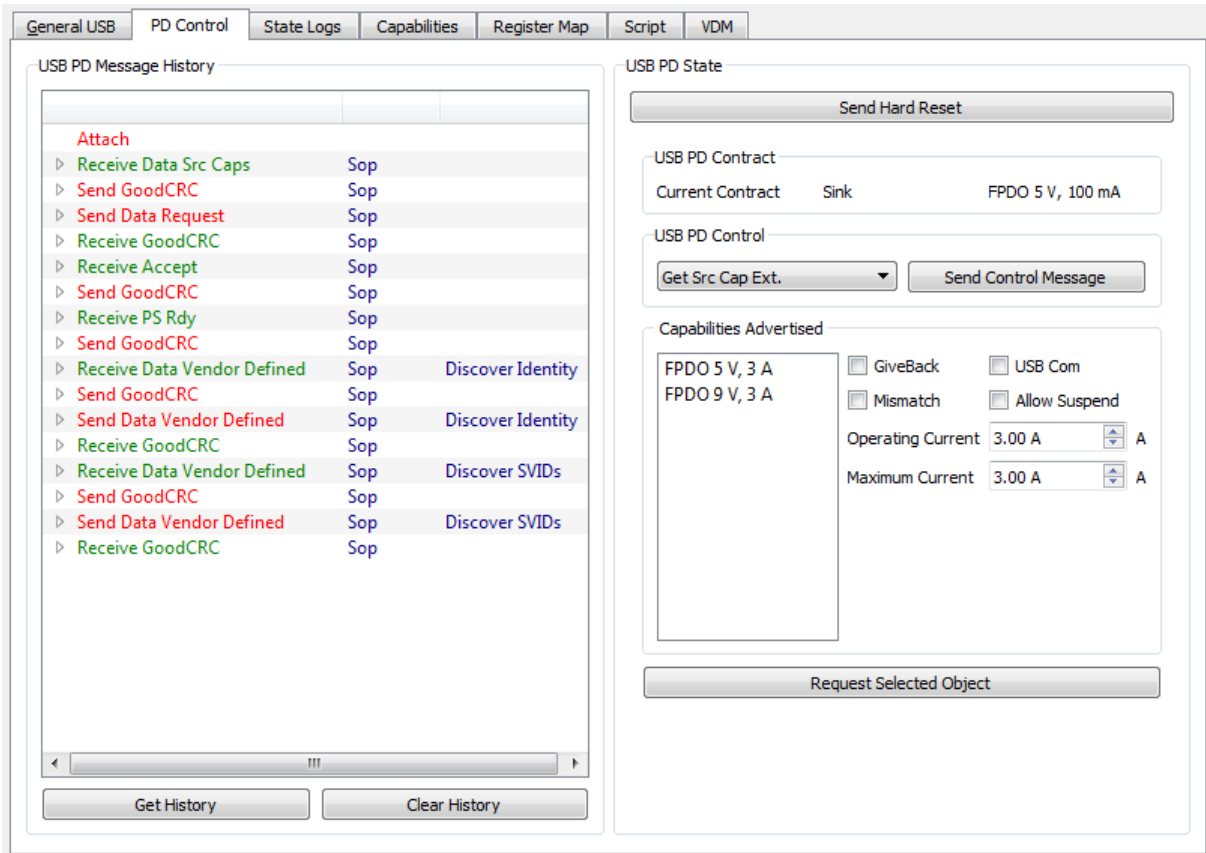

Figure 10. PD Control Tab



# FUSB307BGEVB

## State Logs

Events can be logged in the software by checking the “Auto Poll” option in the Preferences menu. These logs can be useful in debugging and in checking the timing of various operations. Each log message has the timestamp (with 100  $\mu$ s resolution). To stop logging, click the “Auto Poll” option in the Preferences menu.

An example of a Type-C attach and the PD communication flow is shown below.

To support debug efforts, the “Set State” button can be used to force a specific state machine state. The state can be selected in the pull down menu to the left of the “Set State” button.

The screens can be cleared with the “Clear State Log” and “Clear PD State Log” buttons to the right of each window.

Either Type-C State log or Policy Engine State log can be saved to a text log file using the “Save TC Log” and/or “Save PD log” buttons.

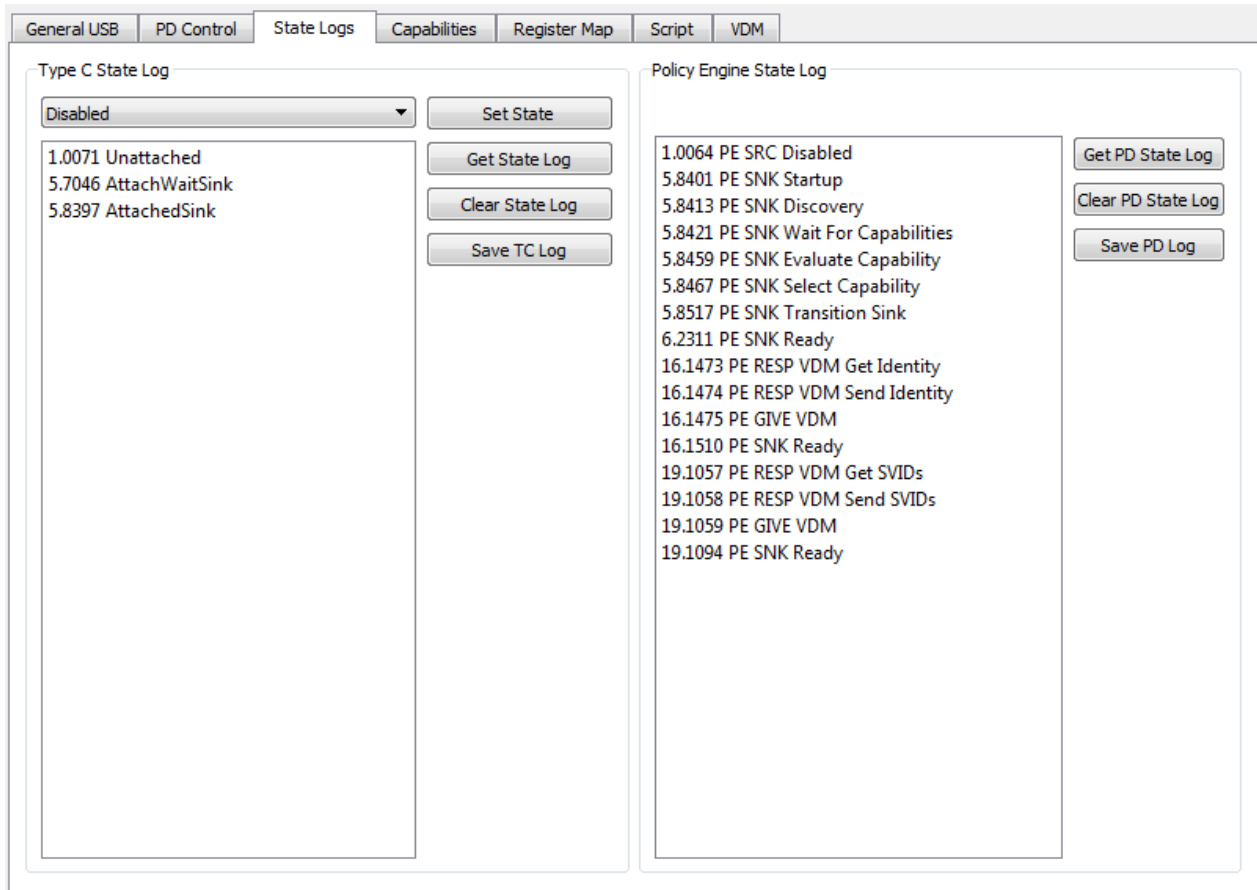

Figure 11. State Logs Tab

# FUSB307BGEVB

## Capabilities

The “Capabilities” tab is to set-up PD functionality of the EVB. The settings in this tab dictate how the PD state machine will respond once a connection is made. It is the programmed source and sink capabilities of the device and

the charging algorithm that is used to automatically select a source capability when connected to a source. Note, the “Read Src Caps”, “Read Sink Caps”, and “Read Settings” buttons need to be clicked to reflect the default settings of the PD state machine.

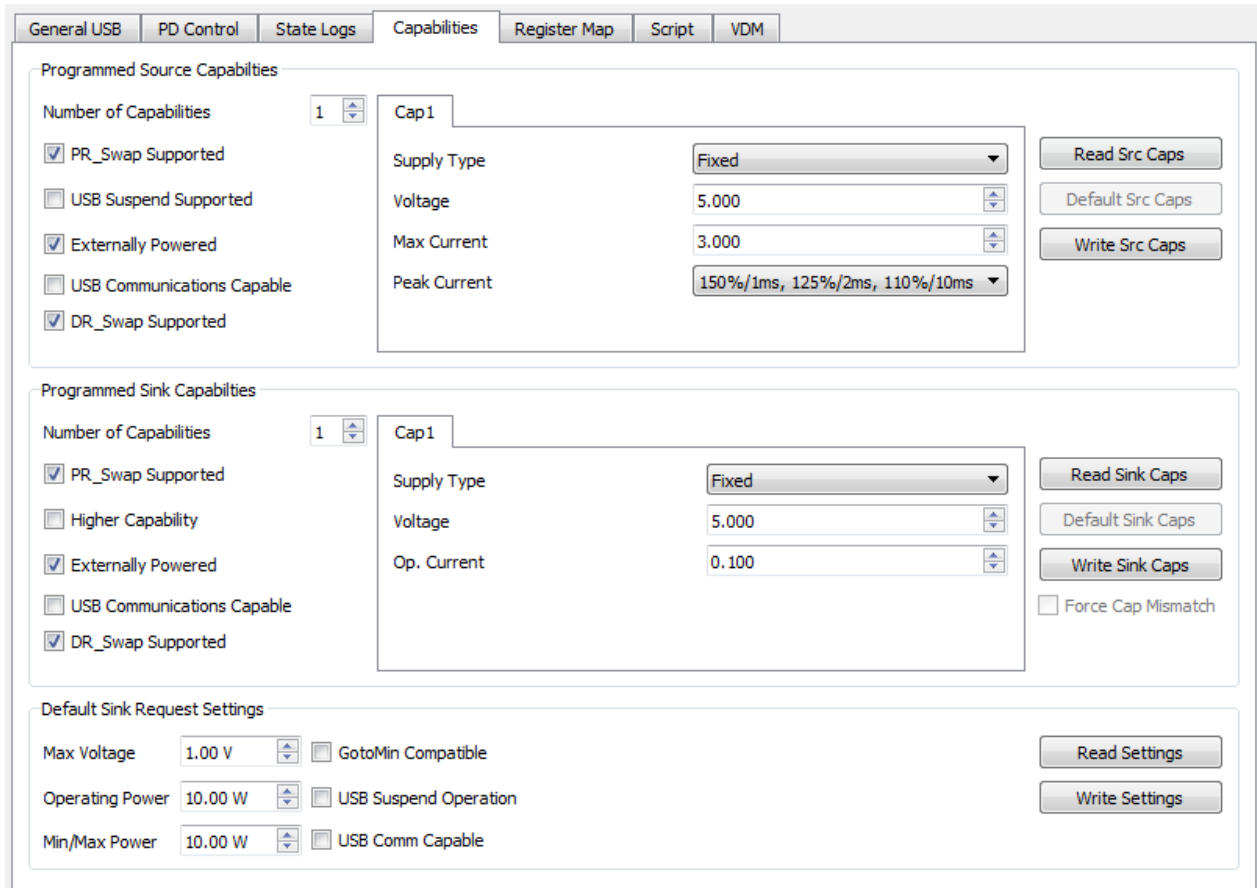

Figure 12. Capacitance Tab

# FUSB307BGEVB

## Register Map

The “Register Map” tab enables reading and writing any value to any register in the FUSB307B. When performing a register write, the selected register/registers is/are read back again to confirm the write action. So the write button actually performs a write and then a read operation.

The “Device Poll” option tells the GUI to automatically check the DEVICE\_ID register for the I<sup>2</sup>C address selected

in the “Addr” pull down box and display the “Device Connected ...” or “ No Device” message in the lower right corner of the GUI.

The “Register Poll” option tells the GUI to constantly poll the FUSB307B registers and update the register values. This should be used only for debugging since it can disrupt the timing operations of the firmware.

The screenshot shows the 'Register Map' tab in a software interface. It features a table with columns for 'Addr', 'Name', 'Data(Hex)', and individual bits from 'Bit7' to 'Bit0'. The data is as follows:

Addr	Name	Data(Hex)	Bit7	Bit6	Bit5	Bit4	Bit3	Bit2	Bit1	Bit0
0x00	VENDIDL	79	Vendor_ID_Low 01111001							
0x01	VENDIDH	07	Vendor_ID_High 00000111							
0x02	PRODIDL	31	Product_ID_Low 00110001							
0x03	PRODIDH	01	Product_ID_High 00000001							
0x04	DEVIDL	02	Device_ID_Low 00000010							
0x05	DEVIDH	00	Device_ID_High 00000000							
0x06	TYPECREVL	12	USB_Type-C_Revision_Low 00010010							
0x07	TYPECREVH	00	USB_Type-C_Revision_High 00000000							
0x08	USBPDVER	12	USB_PD_Version 00010010							
0x09	USBPDREV	20	USB_PD_Revision							

Below the table, there is a control area with an 'Addr' dropdown set to '0xA0', a checked 'Device Poll' checkbox, an unchecked 'Register Poll' checkbox, and four buttons: 'Read All Registers', 'Write All Registers', 'Read Register', and 'Write Register'.

Figure 13. Register Map Tab

# FUSB307BGEVB

## Scripting

This tab enables the use of scripts to configure the FUSB307B. The window in the left side of the tab controls the scripting.

Scripts can be added through the GUI using normal copy/paste methods or imported from an external file using the “Load” button. After achieving a desired setup, a script can also be exported to a file using the “Save” button.

Each line of the script should be formatted as follows:

**Command, port, I<sup>2</sup>C addr, # bytes, register addr, data1, ..., dataN, optional comment**

- The *Command* is: “r” or “w”
- The *port* is always 0
- The *I<sup>2</sup>C addr* is any connected device I<sup>2</sup>C address
- The *# bytes* is the number of bytes to read or write
- The *register addr* is the starting register address
- The *data1, ..., dataN* are for writing values to registers
- And *optional comment* is just informational

Each field can be separated with a space (“ ”), a comma (“,”), or a semicolon (“;”).

The Run button will execute all the lines of the script.

The Step button will execute the highlighted line.

The Loop feature will loop the entire script up to 99 times.

Setting Loop count to 0 will loop indefinitely.

Some example script commands are given below:

- r 0, 0xA0, 2, 0x04; Read DeviceID
- r 0, 0xA0, 1, 0x1A; Read RoleControl
- w 0, 0xA0, 1, 0x1A, 0x1B; Set Rp 1.5A
- w 0, 0xA0, 3, 0x51, 0x02, 0x47, 0x06; Write PD Byte Count and Header for GetSourceCaps
- w 0, 0xA0, 1, 0x50, 0x30; Write Transmit SOP command

Results of an executed script are shown in the box on the right side of the tab. These results can be exported to a file using normal copy and paste functions.

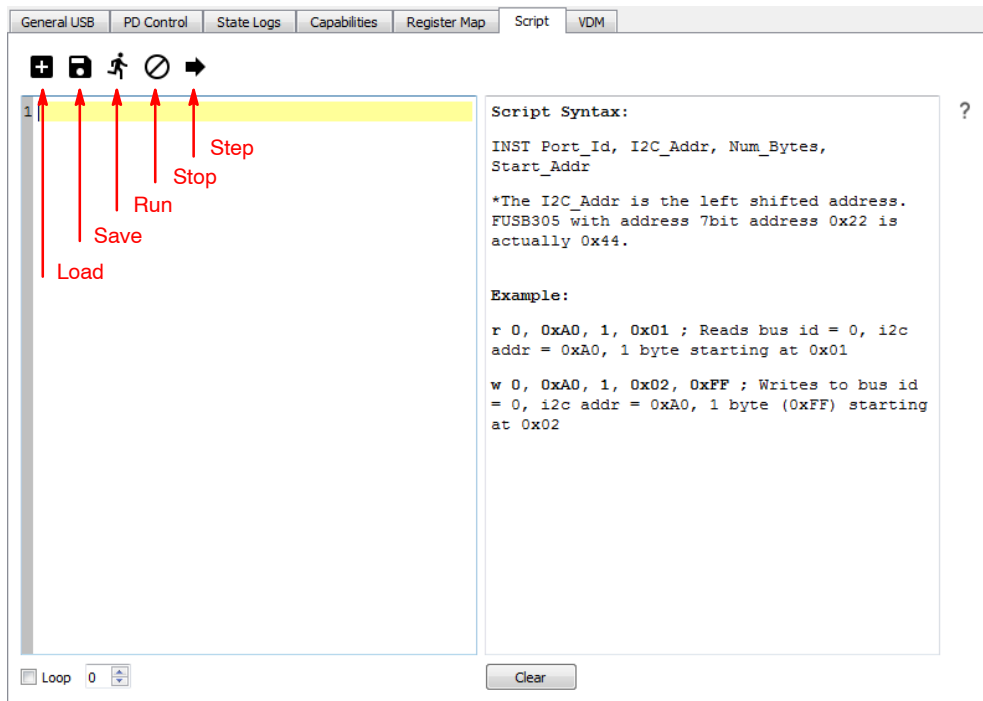

Figure 14. Script Tab

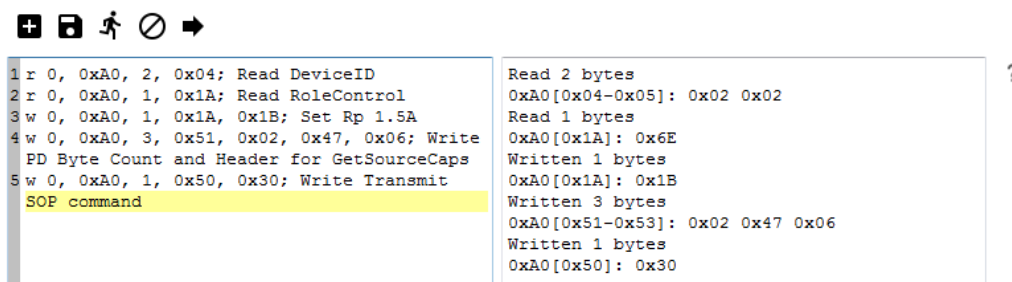

Figure 15. Example Script and Results

# FUSB307BGEVB

## VDM

This tab enables supports Vendor Defined Messages (VDM). The “Configuration” section is used for configuring the FUSB307B. The upper left “FUSB305” section window is used for displaying and modifying or adding VDM information to the EVB. Right-clicking on the Sop field allows you to add SVIDs. Right-clicking on an SVID allows you to remove the SVID or add a Mode. Right-clicking on a Mode allows you to remove it.

Retrieving VDM information from a connected device can be done in the lower left “Other” section window. Right-clicking on Sop allows you to request Discover Identity or Discover SVIDs. Right-clicking on a SVID allows you to request Discover Modes. Right-clicking on a Mode allows you to request to Enter or Exit that Mode.

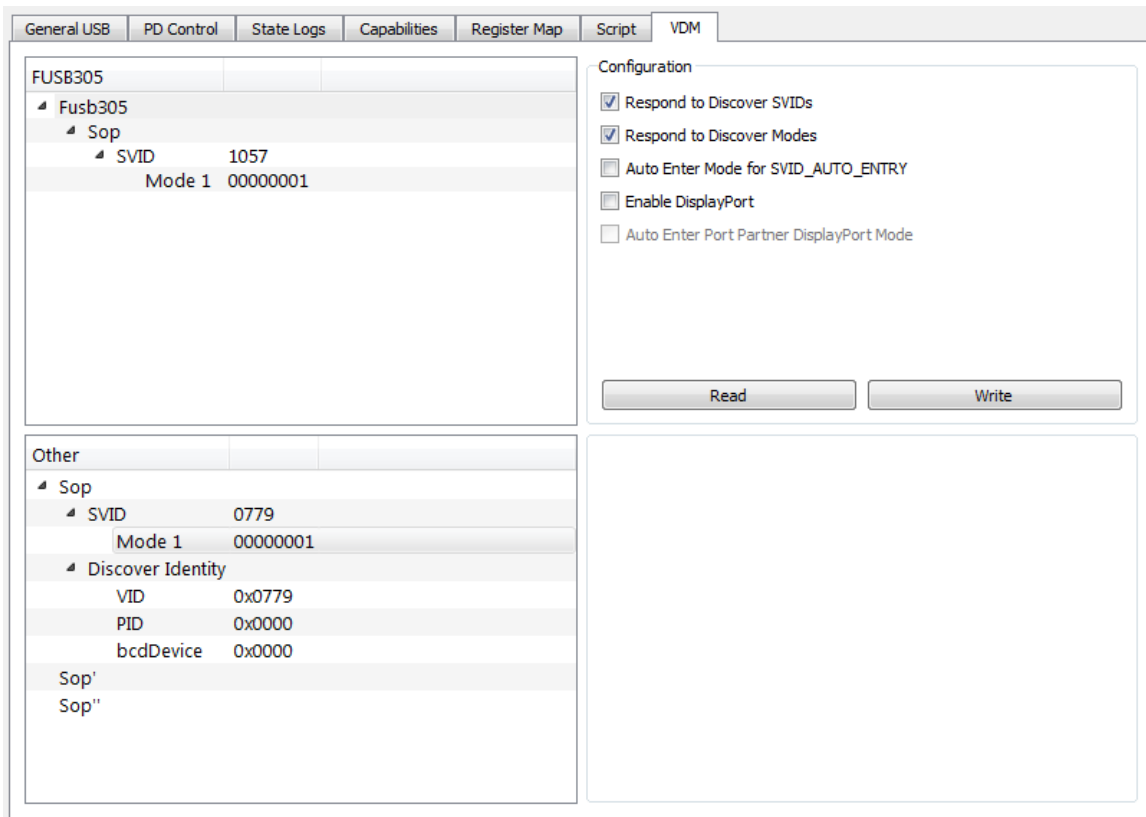

Figure 16. VDM Tab

**onsemi**, **Onsemi**, and other names, marks, and brands are registered and/or common law trademarks of Semiconductor Components Industries, LLC dba "**onsemi**" or its affiliates and/or subsidiaries in the United States and/or other countries. **onsemi** owns the rights to a number of patents, trademarks, copyrights, trade secrets, and other intellectual property. A listing of **onsemi**'s product/patent coverage may be accessed at [www.onsemi.com/site/pdf/Patent-Marking.pdf](http://www.onsemi.com/site/pdf/Patent-Marking.pdf). **onsemi** is an Equal Opportunity/Affirmative Action Employer. This literature is subject to all applicable copyright laws and is not for resale in any manner.

The evaluation board/kit (research and development board/kit) (hereinafter the "board") is not a finished product and is not available for sale to consumers. The board is only intended for research, development, demonstration and evaluation purposes and will only be used in laboratory/development areas by persons with an engineering/technical training and familiar with the risks associated with handling electrical/mechanical components, systems and subsystems. This person assumes full responsibility/liability for proper and safe handling. Any other use, resale or redistribution for any other purpose is strictly prohibited.

**THE BOARD IS PROVIDED BY ONSEMI TO YOU "AS IS" AND WITHOUT ANY REPRESENTATIONS OR WARRANTIES WHATSOEVER. WITHOUT LIMITING THE FOREGOING, ONSEMI (AND ITS LICENSORS/SUPPLIERS) HEREBY DISCLAIMS ANY AND ALL REPRESENTATIONS AND WARRANTIES IN RELATION TO THE BOARD, ANY MODIFICATIONS, OR THIS AGREEMENT, WHETHER EXPRESS, IMPLIED, STATUTORY OR OTHERWISE, INCLUDING WITHOUT LIMITATION ANY AND ALL REPRESENTATIONS AND WARRANTIES OF MERCHANTABILITY, FITNESS FOR A PARTICULAR PURPOSE, TITLE, NON-INFRINGEMENT, AND THOSE ARISING FROM A COURSE OF DEALING, TRADE USAGE, TRADE CUSTOM OR TRADE PRACTICE.**

**onsemi** reserves the right to make changes without further notice to any board.

You are responsible for determining whether the board will be suitable for your intended use or application or will achieve your intended results. Prior to using or distributing any systems that have been evaluated, designed or tested using the board, you agree to test and validate your design to confirm the functionality for your application. Any technical, applications or design information or advice, quality characterization, reliability data or other services provided by **onsemi** shall not constitute any representation or warranty by **onsemi**, and no additional obligations or liabilities shall arise from **onsemi** having provided such information or services.

**onsemi** products including the boards are not designed, intended, or authorized for use in life support systems, or any FDA Class 3 medical devices or medical devices with a similar or equivalent classification in a foreign jurisdiction, or any devices intended for implantation in the human body. You agree to indemnify, defend and hold harmless **onsemi**, its directors, officers, employees, representatives, agents, subsidiaries, affiliates, distributors, and assigns, against any and all liabilities, losses, costs, damages, judgments, and expenses, arising out of any claim, demand, investigation, lawsuit, regulatory action or cause of action arising out of or associated with any unauthorized use, even if such claim alleges that **onsemi** was negligent regarding the design or manufacture of any products and/or the board.

This evaluation board/kit does not fall within the scope of the European Union directives regarding electromagnetic compatibility, restricted substances (RoHS), recycling (WEEE), FCC, CE or UL, and may not meet the technical requirements of these or other related directives.

FCC WARNING – This evaluation board/kit is intended for use for engineering development, demonstration, or evaluation purposes only and is not considered by **onsemi** to be a finished end product fit for general consumer use. It may generate, use, or radiate radio frequency energy and has not been tested for compliance with the limits of computing devices pursuant to part 15 of FCC rules, which are designed to provide reasonable protection against radio frequency interference. Operation of this equipment may cause interference with radio communications, in which case the user shall be responsible, at its expense, to take whatever measures may be required to correct this interference.

**onsemi** does not convey any license under its patent rights nor the rights of others.

LIMITATIONS OF LIABILITY: **onsemi** shall not be liable for any special, consequential, incidental, indirect or punitive damages, including, but not limited to the costs of requalification, delay, loss of profits or goodwill, arising out of or in connection with the board, even if **onsemi** is advised of the possibility of such damages. In no event shall **onsemi**'s aggregate liability from any obligation arising out of or in connection with the board, under any theory of liability, exceed the purchase price paid for the board, if any.

The board is provided to you subject to the license and other terms per **onsemi**'s standard terms and conditions of sale. For more information and documentation, please visit [www.onsemi.com](http://www.onsemi.com).

## ADDITIONAL INFORMATION

### TECHNICAL PUBLICATIONS:

Technical Library: [www.onsemi.com/design/resources/technical-documentation](http://www.onsemi.com/design/resources/technical-documentation)  
onsemi Website: [www.onsemi.com](http://www.onsemi.com)

ONLINE SUPPORT: [www.onsemi.com/support](http://www.onsemi.com/support)

For additional information, please contact your local Sales Representative at [www.onsemi.com/support/sales](http://www.onsemi.com/support/sales)