

# NCV97400

## Automotive Multi-Output Power Management IC (PMIC) for Safety Applications

### Description

The NCV97400 is a 4-output monolithic regulator consisting of 3 buck regulators and 1 boost regulator with supervisory functions including window voltage monitoring on all outputs and a window watchdog timer. This product is ideal for ADAS (Advanced Driver Assistance Systems) applications and utilizes an independent voltage reference and an adjustable independent oscillator to realize the supervisory features.

A 40 V non-synchronous buck regulator converts the battery supply voltage to a 3.3 V output, and delivers up to 3 A (peak). This output rail may be used as the input voltage for the 2 synchronous secondary buck converters and the non-synchronous secondary boost converter. Each secondary buck is adjustable and can be set from 2.5 V to 0.8 V with 2 A peak current limit and can be supplied by up to 3.6 V from a separate supply. The secondary boost output voltage is fixed and is intended to supply a low current 5.0 V rail for In-Vehicle Networking circuits (IVN).

All internal MOSFETs are N-channel devices, and bootstrap circuits are used to drive high side MOSFETs. All 4 SMPS outputs use peak current mode control with internal slope compensation. The IC incorporates an internal regulator that supplies charge to the low-voltage gate drivers.

The NCV97400 is a functional safety solution that reduces the time required to develop safety systems that comply with the International Standards Organization (ISO) 26262. The device includes a range of integrated safety features such as dedicated feedback references, output voltage monitoring, and window watchdog timer.

### Features Voltage Options

- 3 Enabled Buck Converters
- 1 Boost Converter for IVN Supply
- Wide Input of 4.1 to 40 V with Undervoltage Lockout (UVLO)
- Fixed, 2 MHz Base Switching Frequency
- Pseudo-random Spread Spectrum for Improved EMI
- Window Watchdog with Independent References
- Cycle-by-cycle Current Limit Protection
- External Frequency Synchronization
- NCV Prefix for Automotive and Other Applications Requiring Unique Site and Control Change Requirements; AEC-Q100 Qualified and PPAP Capable
- QFN Package with Wettable Flanks (pin edge plating)



ON Semiconductor®

[www.onsemi.com](http://www.onsemi.com)

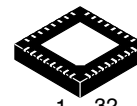

QFNW32  
CASE 484 AB

### MARKING DIAGRAM

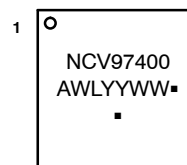

NCV97400 = Specific Device Code  
A = Assembly Location  
WL = Wafer Lot  
YY = Year  
WW = Work Week  
▪ = Pb-Free Package

(Note: Microdot may be in either location)

### ORDERING INFORMATION

See detailed ordering, marking and shipping information on page 26 of this data sheet.

### Typical Applications

- Safety Applications
- ADAS (Advanced Driver Assistance Systems)
- Body Electronics
- Telematics

# NCV97400

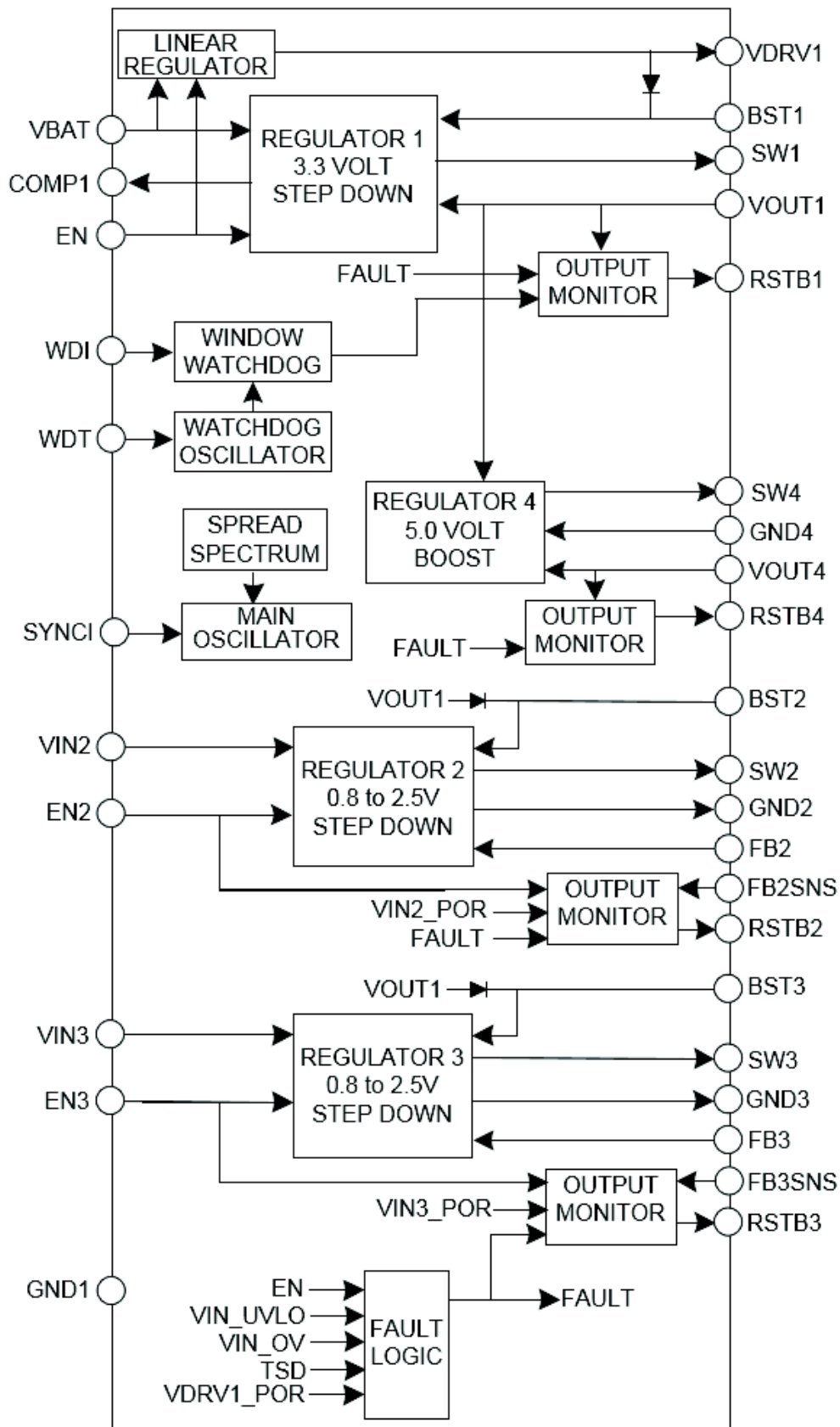

Figure 1. NCV97400 Block Diagram



# NCV97400

**Table 1. MAXIMUM RATINGS**

Rating	Symbol	Value	Unit
Min/Max Voltage VBAT		-0.3 to 40	V
Max Voltage VBAT to SW1		45	V
Min/Max Voltage SW1		-0.7 to 40	V
Min Voltage SW1, SW2, SW3 – 20 ns		-3.0	V
Min/Max Voltage BST1, EN		-0.3 to 40	V
Min/Max Voltage BST2 BST3, SW4		-0.3 to 7.2	V
Min/Max Voltage on EN2, EN3, WDI, SYNC1, SW2, SW3, VOUT4, RSTB1, RSTB2, RSTB3, RSTB4		-0.3 to 6	V
Max Voltage BST1 to SW1, BST2 to SW2, BST3 to SW3		3.6	V
Min/Max Voltage VIN2, VIN3, FB2, FB3, FB2SNS, FB3SNS, VDRV1, COMP1, WDT, VOUT1		-0.3 to 3.6	V
Thermal Resistance, 5x5 QFN Junction-to-Ambient (Note 1)	$R_{\theta JA}$	25	°C/W
Storage Temperature range		-55 to +150	°C
Operating Junction Temperature Range	$T_J$	-40 to +150	°C
ESD withstand Voltage	Human Body Model $V_{ESD}$	2.0	kV
Moisture Sensitivity	MSL	Level 1	
Peak Reflow Soldering Temperature		260	°C

Stresses exceeding those listed in the Maximum Ratings table may damage the device. If any of these limits are exceeded, device functionality should not be assumed, damage may occur and reliability may be affected.

1. Mounted on 1 sq. in. of a 4-layer PCB with 1 oz. copper thickness.

# NCV97400

**Table 2. PIN FUNCTION DESCRIPTIONS**

Pin No.	Symbol	Description
1	VBAT	Input voltage from battery. Place an input filter capacitor in close proximity to this pin.
2	EN	High-voltage (battery), TTL-compatible, master enable signal. Grounding this input stops all outputs and reduces I <sub>q</sub> to a minimum (shutdown mode).
3	SYNCl	Synchronization input. Connecting an external clock to the SYNCl pin synchronizes switching to the rising edge of the SYNCl voltage. If unused, the SYNCl pin should be grounded.
4	WDI	CMOS compatible Watchdog pulse input from a CPU. To be valid, the time between rising edges of this signal must be within the watchdog window time.
5	WDT	Watchdog delay programming. Connect a capacitor between this pin and ground to adjust the watchdog window time.
6	RSTB1	Reset output with adjustable delay. Goes low when the switcher 1 output is out of regulation, during Thermal Shutdown, VBAT over or undervoltage or when a watchdog pulse is not received from the microcontroller.
7	COMP1	Output of the error amplifier for switcher 1
8	FB2_SNS	Feedback of switcher 2 dedicated to voltage monitoring. When not used, short to FB2 (pin 25).
9	RSTB4	Reset output with adjustable delay for switcher 4. Goes low when the output is out of regulation.
10	EN2	TTL-compatible low-voltage enable input for switcher 2. Grounding this input stops switcher 2.
11	RSTB2	Reset output with adjustable delay for switcher 2. Goes low when the output is out of regulation.
12	RSTB3	Reset output with adjustable delay for switcher 3. Goes low when the output is out of regulation.
13	GND1	Ground reference for the IC.
14	FB3_SNS	Feedback of switcher 3 dedicated to voltage monitoring. When not used, short to FB3 (pin 15).
15	FB3	Output voltage sensing for switcher 3, provides adjustability.
16	EN3	TTL-compatible low-voltage enable input for switcher 3. Grounding this input stops switcher 3.
17	BST3	Bootstrap input provides drive voltage higher than VIN3 to the high-side N-channel switch for optimum switch R <sub>DS(on)</sub> and highest efficiency.
18	GND3	Ground connection for the source of the low-side switch of switcher 3.
19	SW3	Switching node of the switcher 3 buck regulator. Connect the output inductor to this pin.
20	VIN3	Low Voltage Input for switcher 3. Place an input filter capacitor in close proximity to this pin. Can be connected to Pin 27 – VOUT1.
21	VIN2	Low Voltage Input for switcher 2. Place an input filter capacitor in close proximity to this pin. Can be connected to Pin 27 – VOUT1.
22	SW2	Switching node of the switcher 2 buck regulator. Connect the output inductor to this pin.
23	GND2	Ground connection for the source of the low-side switch of switcher 2.
24	BST2	Bootstrap input provides drive voltage higher than VIN2 to the high-side N-channel switch for optimum switch R <sub>DS(on)</sub> and highest efficiency.
25	FB2	Output voltage sensing for switcher 2, provides adjustability.
26	VOUT4	Output voltage sensing for switcher 4.
27	VOUT1	Output voltage sensing for switcher 1.
28	GND4	Ground connection for the source of the low-side switch of switcher 4.
29	SW4	Switching node of the switcher 4 boost regulator. Connect the input inductor and anode of the flyback diode to this pin.
30	BST1	Bootstrap input provides drive voltage higher than VBAT to the N-channel Power Switch for optimum switch R <sub>DS(on)</sub> and highest efficiency.
31	VDRV1	Internal supply voltage for driving the low-voltage internal switch. Connect a 0.1 μF to 1.0 μF capacitor from this pin to ground.
32	SW1	Switching node of the switcher 1 buck regulator. Connect the output inductor and cathode of the freewheeling diode to this pin.
Exposed Pad		Must be connected to GND1 (electrical ground) and to a low thermal resistance path to the ambient temperature environment.

# NCV97400

**Table 3. ELECTRICAL CHARACTERISTICS**

( $V_{BAT} = 4.5\text{ V to }28\text{ V}$ ,  $EN = EN2 = EN3 = 5\text{ V}$ ,  $BSTx = SWx + 3.0\text{ V}$ ,  $C_{DRV1} = 0.1\text{ }\mu\text{F}$ . Min/Max values are valid for the temperature range  $-40^{\circ}\text{C} \leq T_J \leq 150^{\circ}\text{C}$  unless noted otherwise, and are guaranteed by test, design or statistical correlation.)

Parameter	Symbol	Conditions	Min	Typ	Max	Unit
-----------	--------	------------	-----	-----	-----	------

## QUIESCENT CURRENT

Quiescent Current, shutdown	$I_{qSD}$	$V_{BAT} = 13.2\text{ V}$ , $T_J = 25^{\circ}\text{C}$ , $V_{EN} = 0\text{ V}$	–	5	10	$\mu\text{A}$
-----------------------------	-----------	--	---	---	----	---------------

## UNDERVOLTAGE LOCKOUT – VBAT (UVLO)

VBAT UVLO Start Threshold	$V_{UV1ST}$	$V_{BAT}$ rising	4.45	–	4.85	V
VBAT UVLO Stop Threshold	$V_{UV1SP}$	$V_{BAT}$ falling	3.7	–	4.1	V
VBAT UVLO Hysteresis	$V_{UV1HY}$		–	0.75	–	V

## ENABLE

Logic Low	$V_{ENLO}$ , $V_{EN2LO}$ , $V_{EN3LO}$		–	–	0.8	V
Logic High	$V_{ENHI}$ , $V_{EN2HI}$ , $V_{EN3HI}$		2.0	–	–	V
Enable Pin Input Current	$I_{EN}$	$V_{EN} = 5\text{ V}$	–	15	20	$\mu\text{A}$
	$I_{EN2}$ , $I_{EN3}$	$V_{EN2} = V_{EN3} = 5\text{ V}$	30	50	70	$\mu\text{A}$
EN Response Time	$t_{EN\_SW1}$	time from EN high to SW1 switching	–	140	–	$\mu\text{s}$
	$t_{EN\_SWX}$	time from end of $t_{EN\_SW1}$ to SW2, 3 & 4 ready	–	3.1	–	ms
	$t_{EN\_REG4}$	time from EN high to VOUT4 in regulation	–	6	–	ms
EN2, EN3 Response Time	$t_{ENX\_SWX}$	after $t_{EN\_SWX}$ , the time from EN2 to EN3 high to SW2 or SW3 switching	–	20	–	$\mu\text{s}$
Disable Response Time	$t_{DISABL}$	time EN Voltage must be $< V_{ENLO}$ in order to force restart	–	2	10	$\mu\text{s}$

## SOFT-START

Soft-Start Ramp Time	$t_{SS1}$	from SW1 switch start to VOUT1 regulation	0.8	1.4	2.0	ms
	$t_{SS2}$	from the later of $t_{EN\_SWX}$ end or EN2 high to VOUT2 regulation	0.8	1.4	2.0	ms
	$t_{SS3}$	from the later of $t_{EN\_SWX}$ end or EN3 high to VOUT3 regulation	0.8	1.4	2.0	ms
	$t_{SS4}$	from the end of $t_{EN\_SWX}$ to VOUT4 regulation	1.6	2.8	4.0	ms

## OUTPUT VOLTAGE

Switcher 1 Output	$V_{OUT}$		3.23	3.3	3.37	V
Switchers 2 and 3 FB Pin Voltage (During Regulation)	$V_{FB2R}$ , $V_{FB3R}$	OUTx connected to FBx through a 10 k $\Omega$ resistor	0.786	0.800	0.814	V
Switcher 4 Output	$V_{OUT4}$		4.9	5.0	5.1	V

## ERROR AMPLIFIER – SWITCHER 1

Transconductance	$g_m$ $g_m(\text{HV})$	$V_{COMP} = 1.1\text{ V}$				mmho
		$4.5\text{ V} < V_{BAT} < 18\text{ V}$	0.6	1.0	1.4	
		$20\text{ V} < V_{BAT} < 28\text{ V}$	0.35	0.55	0.75	
Output Resistance	$R_{OUT}$		–	1.4	–	M $\Omega$
COMP Source Current Limit	$I_{SOURCE}$	$V_{OUT} = 2.8\text{ V}$ , $V_{COMP} = 1.1\text{ V}$				$\mu\text{A}$
		$4.5\text{ V} < V_{BAT} < 18\text{ V}$	50	75	100	
		$20\text{ V} < V_{BAT} < 28\text{ V}$	25	40	55	
COMP Sink Current Limit	$I_{SINK}$	$V_{OUT} = 3.8\text{ V}$ , $V_{COMP} = 1.1\text{ V}$				$\mu\text{A}$
		$4.5\text{ V} < V_{BAT} < 18\text{ V}$	50	75	100	
		$20\text{ V} < V_{BAT} < 28\text{ V}$	25	40	55	

# NCV97400

**Table 3. ELECTRICAL CHARACTERISTICS**

( $V_{BAT} = 4.5\text{ V to }28\text{ V}$ ,  $EN = EN2 = EN3 = 5\text{ V}$ ,  $BSTx = SWx + 3.0\text{ V}$ ,  $C_{DRV1} = 0.1\text{ }\mu\text{F}$ . Min/Max values are valid for the temperature range  $-40^{\circ}\text{C} \leq T_J \leq 150^{\circ}\text{C}$  unless noted otherwise, and are guaranteed by test, design or statistical correlation.) (continued)

Parameter	Symbol	Conditions	Min	Typ	Max	Unit
<b>ERROR AMPLIFIER – SWITCHER 1</b>						
Minimum COMP Voltage	$V_{CMPMIN}$	$V_{OUT} = 3.8\text{ V}$		0.15	0.3	V
Maximum COMP Voltage	$V_{CMPMAX}$	$V_{OUT} = 2.8\text{ V}$	1.3	1.6		V
<b>OSCILLATOR</b>						
Base Switching Frequency – Switcher 1	$f_{SW1}$	$4.5 < V_{BAT} < 18\text{ V}$ (see Spread Spectrum Section)	1.8	2.0	2.2	MHz
Switching Frequency – Switcher 1	$f_{SW1(HV)}$	$20\text{ V} < V_{BAT} < 28\text{ V}$	0.9	1.0	1.1	MHz
Base Switching Frequency – Switchers 2,3, & 4	$f_{SW2}, f_{SW3}, f_{SW4}$	(see Spread Spectrum Section)	1.8	2.0	2.2	MHz
Maximum Spread Spectrum Frequency	$f_{SS-MAX}$	(see Spread Spectrum Section)	–	2.60	2.85	MHz
<b>SYNCHRONIZATION</b>						
SYNCI Pin Input Current	$I_{SYNCI}$	$V_{SYNCI} = 5.0\text{ V}$	30	50	70	$\mu\text{A}$
SYNCI Input High Voltage	$V_{SYNCIH}$		2.0	–	–	V
SYNCI Input Low Voltage	$V_{SYNCIL}$		–	–	0.8	V
SYNCI High Pulse Width	$t_{SYNCIH}$	$V_{SYNCI} > V_{SYNCIH}$	40	–	–	ns
SYNCI Low Pulse Width	$t_{SYNCIL}$	$V_{SYNCI} < V_{SYNCIL}$	40	–	–	ns
External Synchronization Frequency	$f_{SYNCI}$		1.8	–	2.6	MHz
Master Reassertion Time	$t_{SYNCIMR}$	Time between last synchronized SW rising edge and first unsynchronized SW rising edge.	–	650	810	ns
<b>VBAT OVERVOLTAGE SHUTDOWN MONITOR</b>						
Overvoltage Stop Threshold	$V_{OV1SP}$	$V_{BAT}$ rising	37	–	40	V
Overvoltage Start Threshold	$V_{OV1ST}$	$V_{BAT}$ falling	34	–	–	V
Overvoltage Hysteresis	$V_{OV1HY}$		0.6	–	2.7	V
<b>VBAT FREQUENCY FOLDBACK MONITOR</b>						
Frequency Foldback Threshold	$V_{FL1U}$ $V_{FL1D}$	$V_{BAT}$ rising $V_{BAT}$ falling	18.4 18	–	20 19.8	V
Frequency Foldback Hysteresis	$V_{FL1HY}$		0.2	0.3	0.4	V
<b>SLOPE COMPENSATION</b>						
Ramp Slope – Switcher 1 (With respect to switch current)	$S_{ramp1}$ $S_{ramp1(HV)}$	$4.5 < V_{BAT} < 18\text{ V}$ $20\text{ V} < V_{BAT} < 28\text{ V}$	1.8 0.8	–	3.4 1.6	$\text{A}/\mu\text{s}$
Ramp Slope – Switchers 2 & 3	$S_{ramp2}$		1.9	–	3.7	$\text{A}/\mu\text{s}$
Ramp Slope – Switcher 4	$S_{ramp4}$		0.55	0.8	1.05	$\text{A}/\mu\text{s}$
<b>POWER SWITCH – SWITCHER 1</b>						
ON Resistance	$R_{DS1ON}$	$V_{BST1} = V_{SW1} + 3.0\text{ V}$ , $I_{SW1} = 500\text{ mA}$	–	–	360	$\text{m}\Omega$
Leakage current VBAT to SW1	$I_{LKSW1}$	$V_{EN} = 0\text{ V}$ , $V_{SW1} = 0\text{ V}$ , $V_{BAT} = 18\text{ V}$	–	–	10	$\mu\text{A}$
Minimum ON Time	$t_{ON1MIN}$	Measured at SW1 pin	45	–	70	ns
Minimum OFF Time	$t_{OFF1MIN}$	Measured at SW1 pin	30	50	70	ns
<b>POWER SWITCHES – SWITCHER 2</b>						
High–Side ON Resistance	$R_{HS2ON}$	$V_{BST2} = V_{SW2} + 3.0\text{ V}$ , $I_{SW2} = 500\text{ mA}$	–	–	280	$\text{m}\Omega$
Low–Side ON Resistance	$R_{LS2ON}$	$V_{BST2} = V_{SW2} + 3.0\text{ V}$ , $I_{SW2} = 500\text{ mA}$	–	–	230	$\text{m}\Omega$
Leakage Current (high–side switch)	$I_{LKSW2}$	$V_{EN2} = 0\text{ V}$ , $V_{SW2} = 0\text{ V}$ , $V_{IN2} = 3.3\text{ V}$	–	–	5	$\mu\text{A}$
Minimum ON Time	$t_{ON2MIN}$	Measured at SW2 pin	60	80	95	ns
Minimum OFF Time	$t_{OFF2MIN}$	Measured at SW2 pin	35	55	75	ns
Non–overlap Time			–	10	–	ns

# NCV97400

**Table 3. ELECTRICAL CHARACTERISTICS**

( $V_{BAT} = 4.5\text{ V to }28\text{ V}$ ,  $EN = EN2 = EN3 = 5\text{ V}$ ,  $BSTx = SWx + 3.0\text{ V}$ ,  $C_{DRV1} = 0.1\text{ }\mu\text{F}$ . Min/Max values are valid for the temperature range  $-40^{\circ}\text{C} \leq T_J \leq 150^{\circ}\text{C}$  unless noted otherwise, and are guaranteed by test, design or statistical correlation.) (continued)

Parameter	Symbol	Conditions	Min	Typ	Max	Unit
<b>POWER SWITCHES – SWITCHER 3</b>						
High-Side ON Resistance	$R_{HS3ON}$	$V_{BST3}=V_{SW3}+3.0\text{ V}$ , $I_{SW3}=500\text{ mA}$	–	–	280	m $\Omega$
Low-Side ON Resistance	$R_{LS3ON}$	$V_{BST3}=V_{SW3}+3.0\text{ V}$ , $I_{SW3}=500\text{ mA}$	–	–	230	m $\Omega$
Leakage current (high-side switch)	$I_{LKS3}$	$V_{EN3}=0\text{ V}$ , $V_{SW3}=0\text{ V}$ , $V_{IN3}=3.3\text{ V}$	–	–	5	$\mu\text{A}$
Minimum ON Time	$t_{ON3MIN}$	Measured at SW3 pin	60	80	95	ns
Minimum OFF Time	$t_{OFF3MIN}$	Measured at SW3 pin	35	55	75	ns
Non-overlap Time	$t_{NOVLP}$		–	10	–	ns
<b>POWER SWITCH – SWITCHER 4</b>						
ON Resistance	$R_{DS4ON}$	$I_{SW4}=100\text{ mA}$	–	–	1.0	$\Omega$
Switch Leakage Current	$I_{LKS4}$	$V_{EN}=0\text{ V}$ , $V_{SW4}=5.0\text{ V}$	–	–	5	$\mu\text{A}$
Minimum ON Time	$t_{ON4MIN}$	Measured at SW4 pin	65	85	100	ns
Minimum OFF Time	$t_{OFF4MIN}$	Measured at SW4 pin	35	55	75	ns
<b>PEAK CURRENT LIMITS</b>						
Current Limit Threshold – Switcher 1	$I_{LIM1}$		3.9	4.4	4.9	A
Current Limit Threshold – Switcher 2	$I_{LIM2}$		2.6	2.9	3.2	A
Current Limit Threshold – Switcher 3	$I_{LIM3}$		2.6	2.9	3.2	A
Current Limit Threshold – Switcher 4	$I_{LIM4}$		0.72	0.9	1.08	A
<b>SHORT CIRCUIT FREQUENCY FOLDBACK – SWITCHER 1</b>						
Lowest Foldback Frequency	$f_{SW1AF}$	$V_{OUT} = 0\text{ V}$ , $4.5\text{ V} < V_{BAT} < 18\text{ V}$	450	550	650	kHz
Lowest Foldback Frequency – High $V_{IN}$	$f_{SW1AFHV}$	$V_{OUT} = 0\text{ V}$ , $20\text{ V} < V_{BAT} < 28\text{ V}$	225	275	325	
<b>HICCUP MODE</b>						
Hiccup Mode	$f_{SW1HIC}$	SW1 pin shorted to ground or VOUT1 $V_{OUT1} = 0\text{ V}$	24	32	40	kHz
	$f_{SW2HIC}$	SW2 pin shorted to ground or VOUT2	24	32	40	
	$f_{SW3HIC}$	SW3 pin shorted to ground or VOUT3	24	32	40	
	$f_{SW4HIC}$	SW4 pin connected to +3.3 V through 20 $\Omega$ . 0 V at the VOUT4 pin.	24	32	40	
Switching Reactivation Delay	$t_{SW4HIC}$	SW4 pin shorted to VOUT1	–	1.9	–	ms
<b>WINDOW WATCHDOG</b>						
Watchdog Oscillator Frequency	$f_{WD}$	$C_{WDT} = 1000\text{ pF}$ $C_{WDT} = 100\text{ pF}$	8.2 77	10.6 100	13.0 122	kHz
First Watchdog Timeout	$t_{WD\_timeout}$	Watchdog timeout after rising edge at RSTB1 $C_{WDT} = 1000\text{ pF}$ $900\text{ pF} < C_{WDT} < 1100\text{ pF}$ $C_{WDT} = 100\text{ pF}$ $90\text{ pF} < C_{WDT} < 110\text{ pF}$	2300 2070 240 221	2840 – 300 –	3700 4090 385 430	ms
Watchdog Window Time	$t_{WD}$	$C_{WDT} = 1000\text{ pF}$ $900\text{ pF} < C_{WDT} < 1100\text{ pF}$ $C_{WDT} = 100\text{ pF}$ $90\text{ pF} < C_{WDT} < 110\text{ pF}$	150 138 15.9 14.7	189 – 20 –	250 273 27 28.7	ms
Watchdog Closed Window Time	$t_{WD\_CLS}$		–	$t_{WD}/4$	–	ms
Watchdog Input WDI Threshold Voltage	$V_{WDH}$	$V_{WD}$ increasing	–	–	2.0	V
	$V_{WDL}$	$V_{WI}$ decreasing	0.8	–	–	V
	$V_{WD\_HYS}$		150	–	500	mV
Watchdog Input WDI Current	$I_{WDI}$	$V_{WD} = 5\text{ V}$	30	50	70	$\mu\text{A}$



# NCV97400

**Table 3. ELECTRICAL CHARACTERISTICS**

( $V_{BAT} = 4.5\text{ V to }28\text{ V}$ ,  $EN = EN2 = EN3 = 5\text{ V}$ ,  $BSTx = SWx + 3.0\text{ V}$ ,  $C_{DRV1} = 0.1\text{ }\mu\text{F}$ . Min/Max values are valid for the temperature range  $-40^{\circ}\text{C} \leq T_J \leq 150^{\circ}\text{C}$  unless noted otherwise, and are guaranteed by test, design or statistical correlation.) (continued)

Parameter	Symbol	Conditions	Min	Typ	Max	Unit
<b>RESET</b>						
Low Voltage Reset Threshold – Switcher 1	$V_{UV1FAL}$ $V_{UV1RIS}$	$V_{OUT1}$ decreasing $V_{OUT1}$ increasing	2.97 3.04	3.05 3.12	3.14 3.20	V
High Voltage Reset Threshold – Switcher 1	$V_{OV1FAL}$ $V_{OV1RIS}$	$V_{OUT1}$ decreasing $V_{OUT1}$ increasing	3.40 3.47	3.48 3.55	3.56 3.63	V
Low Voltage Reset Threshold – Switcher 2 & 3 (at FBxSNS)	$V_{UV2FAL}$ $V_{UV2RIS}$	FBxSNS decreasing FBxSNS increasing	0.720 0.736	0.740 0.756	0.760 0.776	V
High Voltage Reset Threshold – Switcher 2 & 3 (at FBxSNS)	$V_{OV2FAL}$ $V_{OV2RIS}$	FBxSNS decreasing FBxSNS increasing	0.824 0.840	0.844 0.860	0.864 0.880	V
Low Voltage Reset Threshold – Switcher 4	$V_{UV4FAL}$ $V_{UV4RIS}$	$V_{OUT4}$ decreasing $V_{OUT4}$ increasing	4.50 4.60	4.63 4.73	4.75 4.85	V
High Voltage Reset Threshold – Switcher 4	$V_{OV4FAL}$ $V_{OV4RIS}$	$V_{OUT4}$ decreasing $V_{OUT4}$ increasing	5.15 5.25	5.28 5.38	5.40 5.50	V
Reset Hysteresis (ratio of $V_{OUTx}$ )	$K_{RES\_HYS}$		0.5	2	–	%
Noise-Filtering Delay	$t_{RES\_FLT}$		5	–	25	$\mu\text{s}$
Reset Delay Time	$t_{RESET}$	$I_{RSTBx} = 1\text{ mA}$ $I_{RSTBx} = 500\text{ }\mu\text{A}$ $I_{RSTBx} = 100\text{ }\mu\text{A}$	– 4.0 18	1.0 5.0 24	40 6.0 32	$\mu\text{s}$ ms ms
Reset Output Low level	$V_{RESL}$	$I_{RSTBx} = 1\text{ mA}$	–	–	0.4	V
<b>BOOTSTRAP VOLTAGE SUPPLY</b>						
Output Voltage	$V_{DRV1}$		3.1	3.3	3.5	V
$V_{DRV1}$ POR Start Threshold	$V_{DRV1ST}$		2.7	2.875	3.05	V
$V_{DRV1}$ POR Stop Threshold	$V_{DRV1SP}$		2.55	2.75	2.95	V
<b>SW2 &amp; SW3 INPUT UNDERVOLTAGE MONITORS</b>						
VIN2 POR Start Threshold	$V_{IN2ST}$		2.7	2.875	3.05	V
VIN2 POR Stop Threshold	$V_{IN2SP}$		2.55	2.75	2.95	V
VIN3 POR Start Threshold	$V_{IN3ST}$		2.7	2.875	3.05	V
VIN3 POR Stop Threshold	$V_{IN3SP}$		2.55	2.75	2.95	V
<b>THERMAL SHUTDOWN</b>						
Thermal Shutdown Activation Temperature	$T_{SD}$		150	–	190	$^{\circ}\text{C}$
Hysteresis	$T_{HYS}$		5	–	20	$^{\circ}\text{C}$

Product parametric performance is indicated in the Electrical Characteristics for the listed test conditions, unless otherwise noted. Product performance may not be indicated by the Electrical Characteristics if operated under different conditions.

TYPICAL CHARACTERISTICS

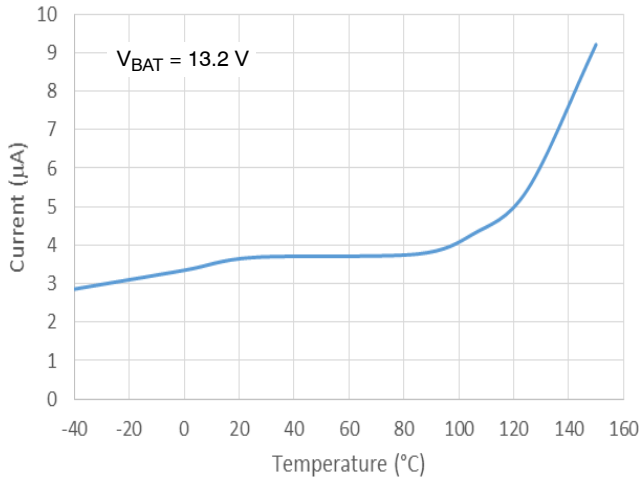

Figure 3. Shutdown  $V_{BAT}$  Quiescent Current vs. Temperature

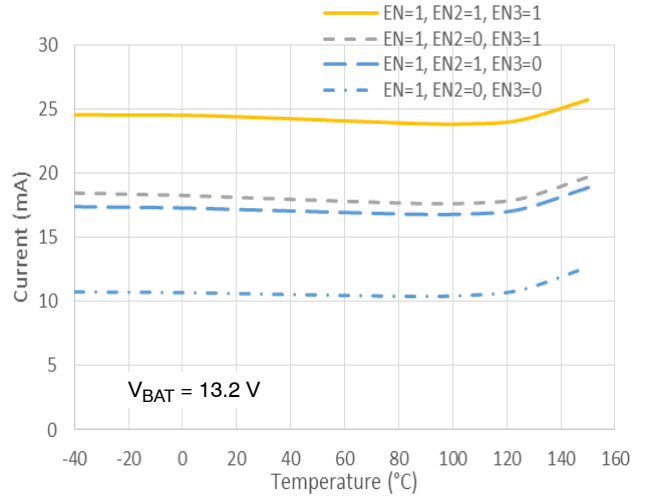

Figure 4. Operating  $V_{BAT}$  Quiescent Current vs. Temperature

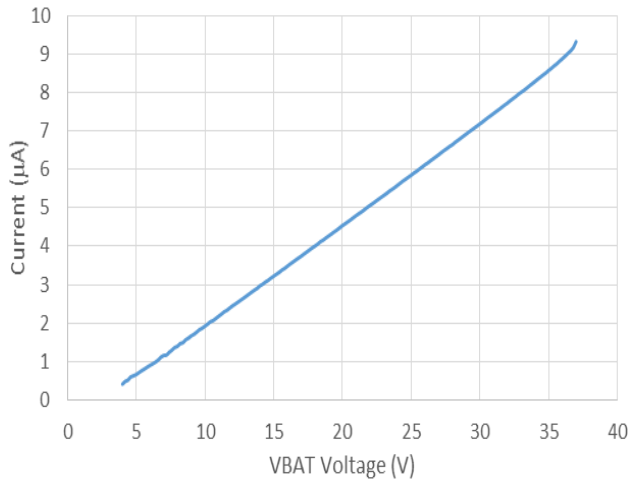

Figure 5. Shutdown  $V_{BAT}$  Quiescent Current vs.  $V_{BAT}$  Voltage

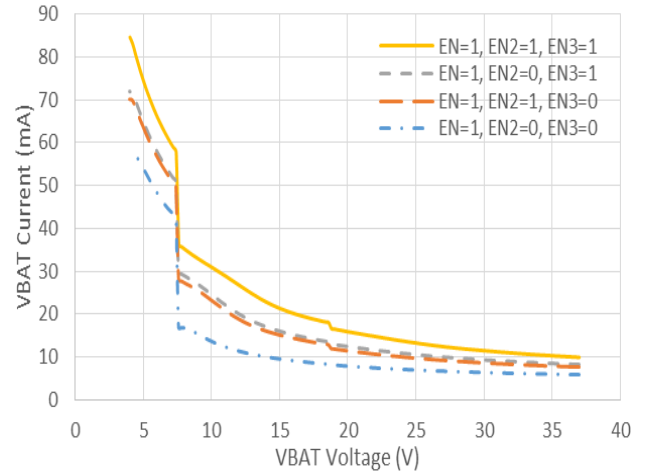

Figure 6. Operating  $V_{BAT}$  Quiescent Current vs.  $V_{BAT}$  Voltage

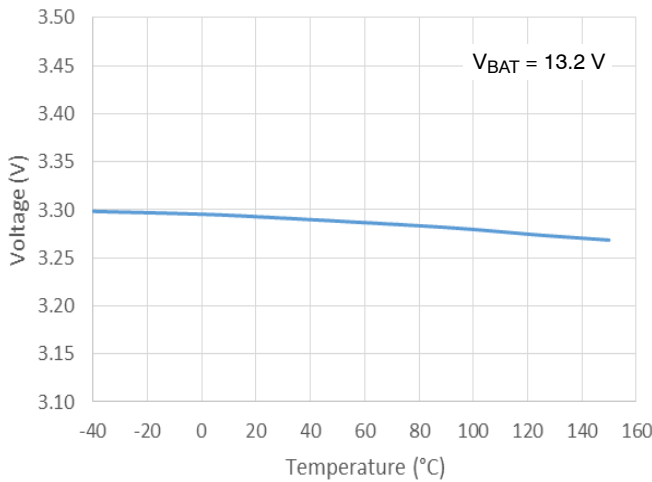

Figure 7.  $V_{DRV}$  Voltage vs. Temperature

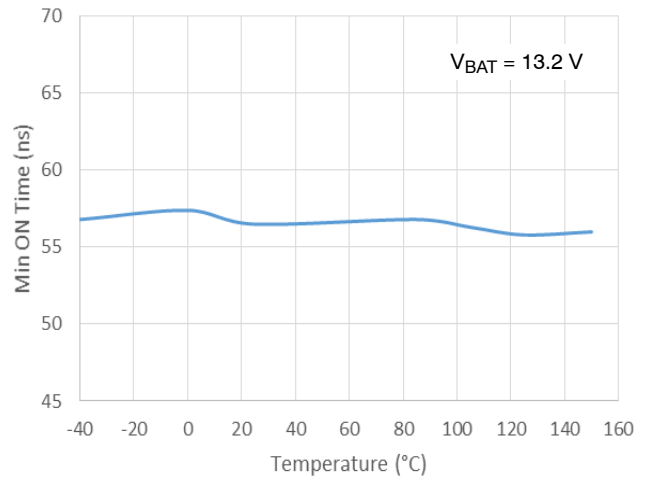

Figure 8. Switcher 1 Min ON Time vs. Temperature

TYPICAL CHARACTERISTICS

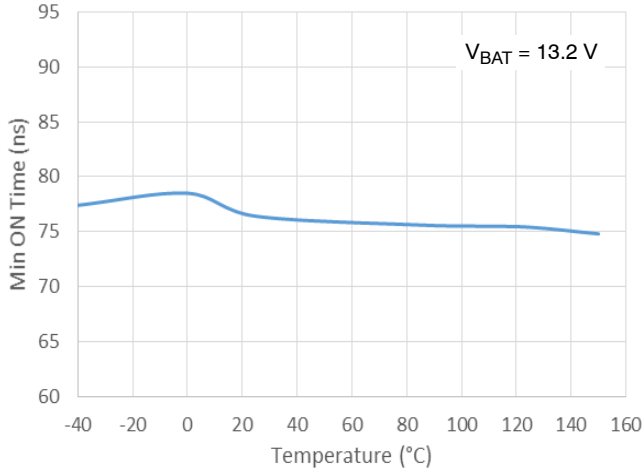

Figure 9. Switcher 2 Min ON Time vs. Temperature

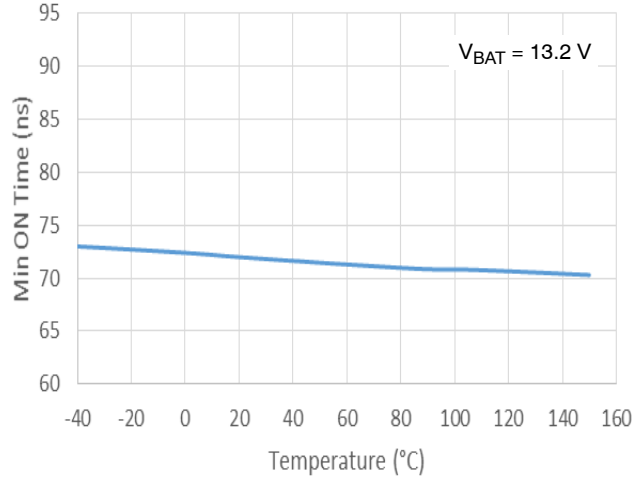

Figure 10. Switcher 3 Min ON Time vs. Temperature

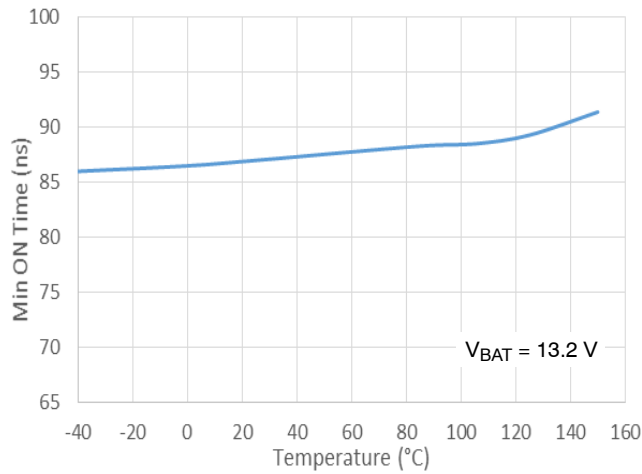

Figure 11. Switcher 4 Min ON Time vs. Temperature

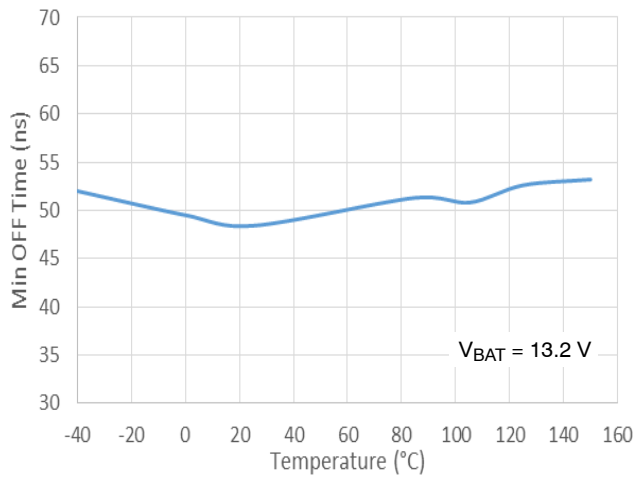

Figure 12. Switcher 1 Min OFF Time vs. Temperature

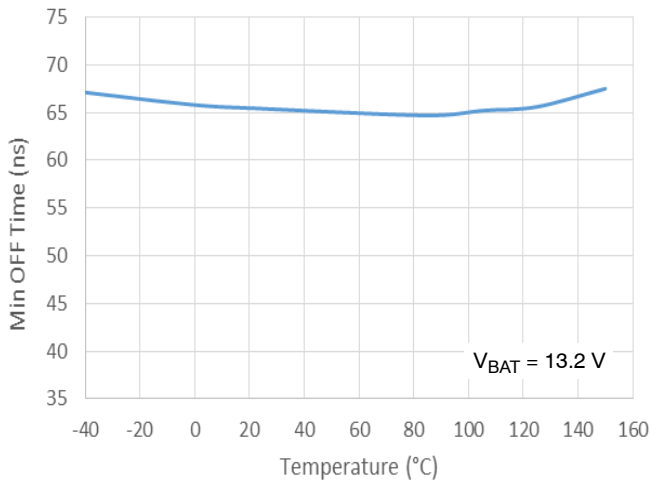

Figure 13. Switcher 2 Min OFF Time vs. Temperature

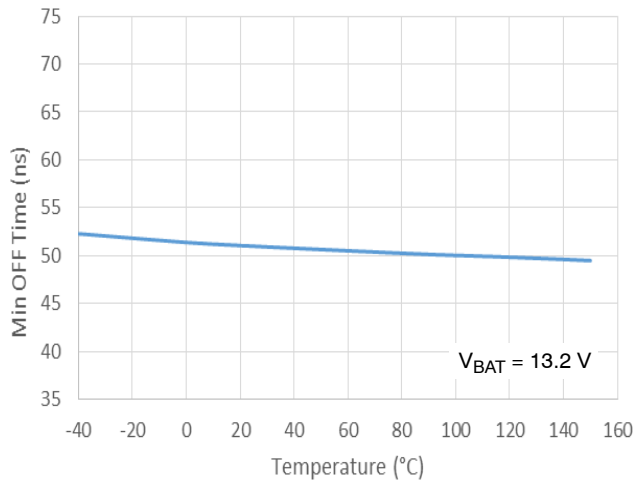

Figure 14. Switcher 3 Min OFF Time vs. Temperature

TYPICAL CHARACTERISTICS

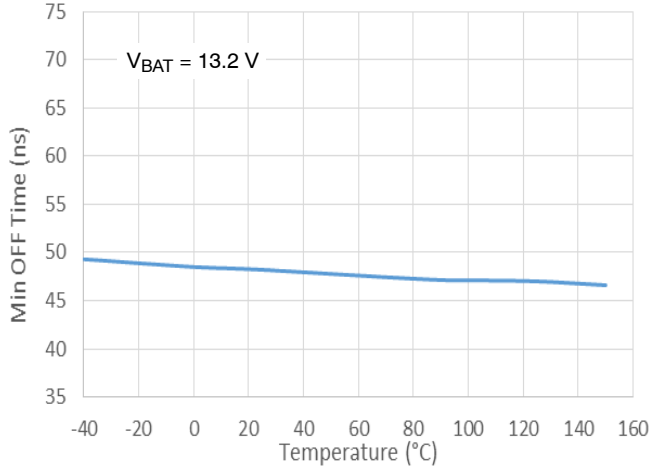

Figure 15. Switcher 4 Min OFF Time vs. Temperature

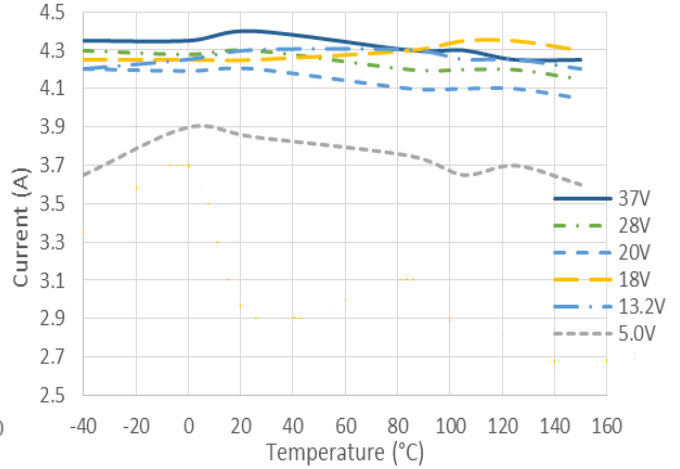

Figure 16. Switcher 1 Load Current Limit vs. Temperature

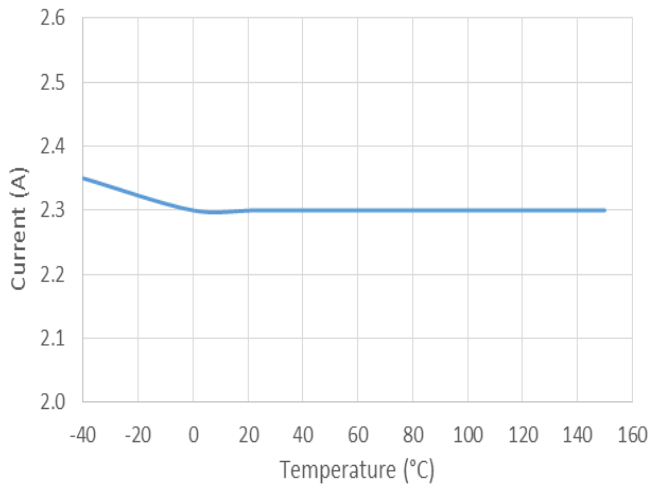

Figure 17. Switcher 2 Load Current Limit vs. Temperature – 1.8 V Output

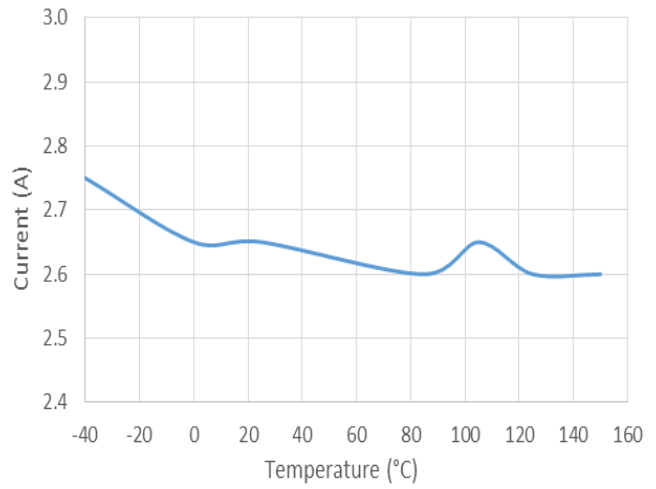

Figure 18. Switcher 3 Load Current Limit vs. Temperature – 1.2 V Output

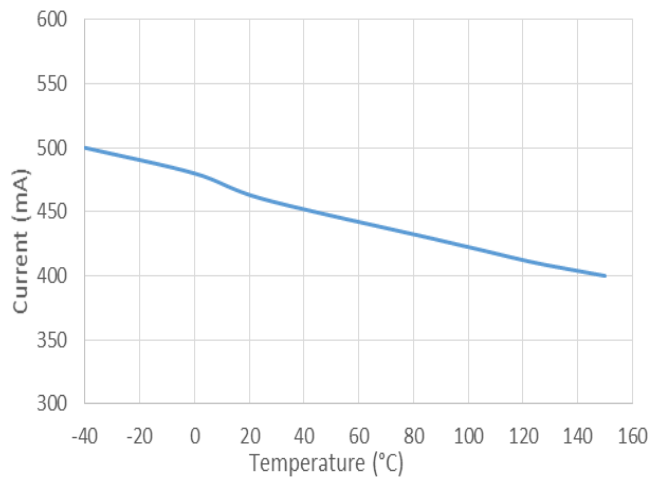

Figure 19. Switcher 4 Load Current Limit vs. Temperature

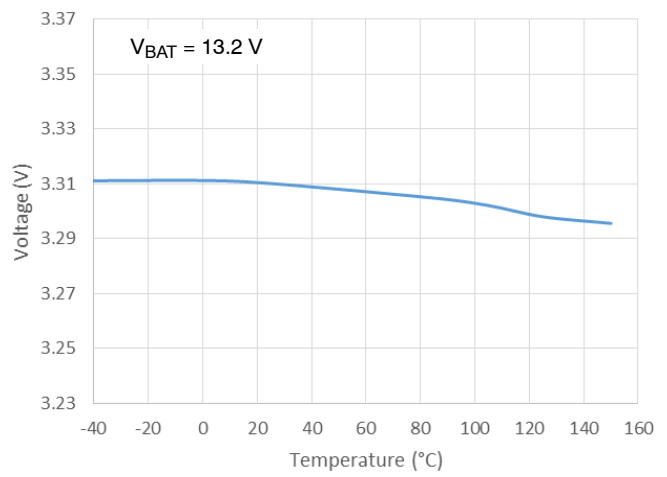

Figure 20. Switcher 1 Output Voltage vs. Temperature

TYPICAL CHARACTERISTICS

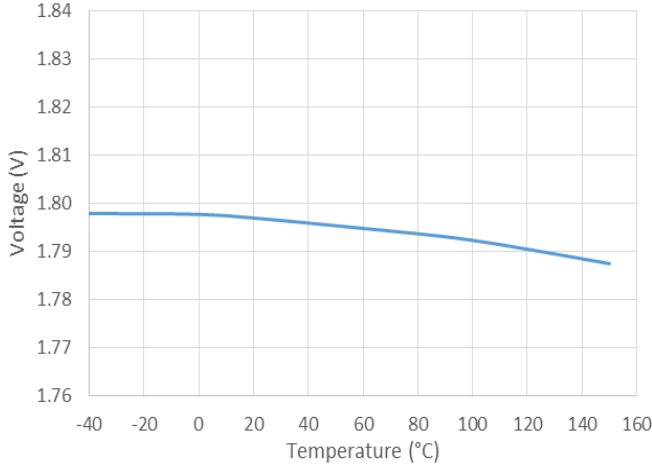

Figure 21. Switcher 2 Output Voltage vs. Temperature

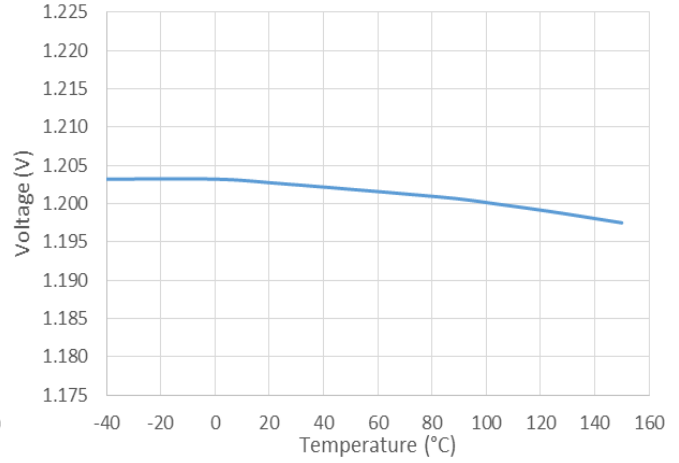

Figure 22. Switcher 3 Output Voltage vs. Temperature

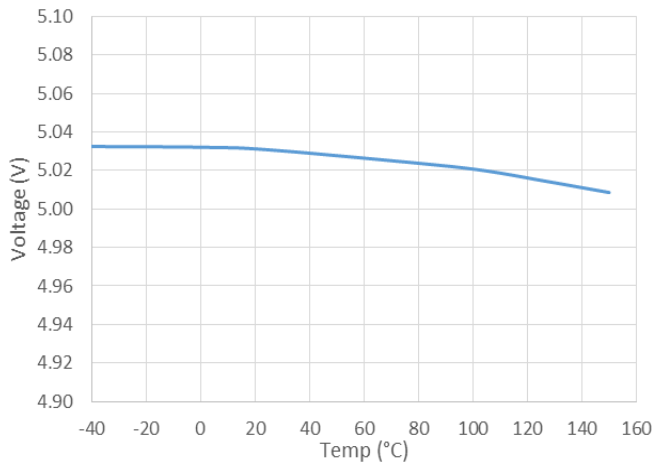

Figure 23. Switcher 4 Output Voltage vs. Temperature

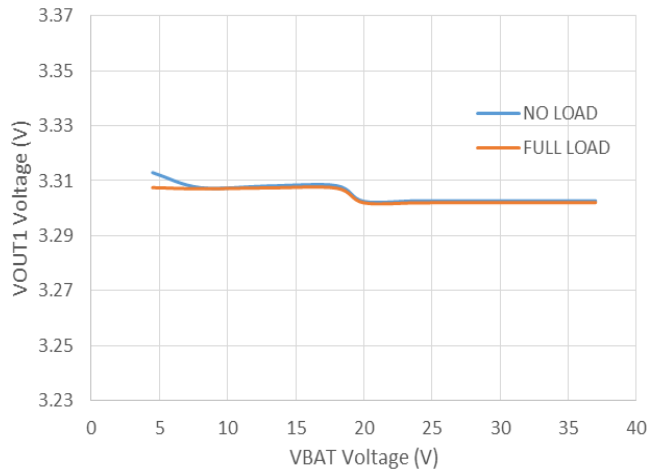

Figure 24. Switcher 1 Output Voltage vs. V<sub>BAT</sub> Voltage

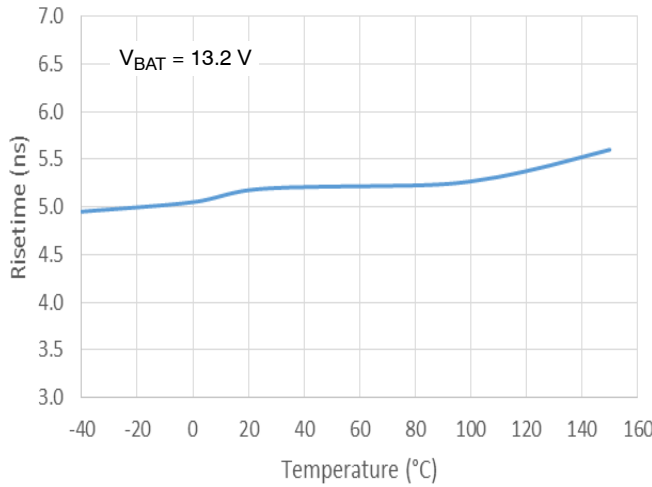

Figure 25. Switchnode 1 2.8 A Load Risetime vs. Temperature

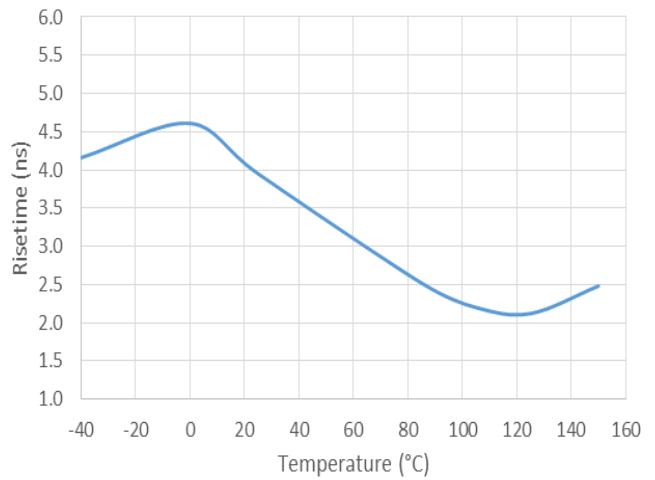

Figure 26. Switchnode 2 2.0 A Load Risetime vs. Temperature

TYPICAL CHARACTERISTICS

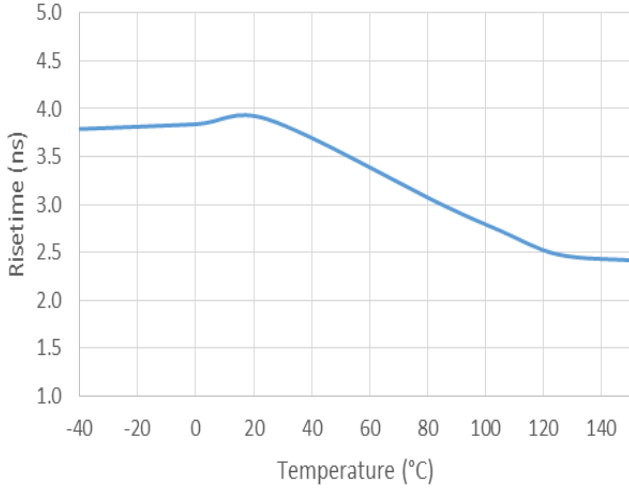

Figure 27. Switchnode 3 2.0 A Load Risetime vs. Temperature

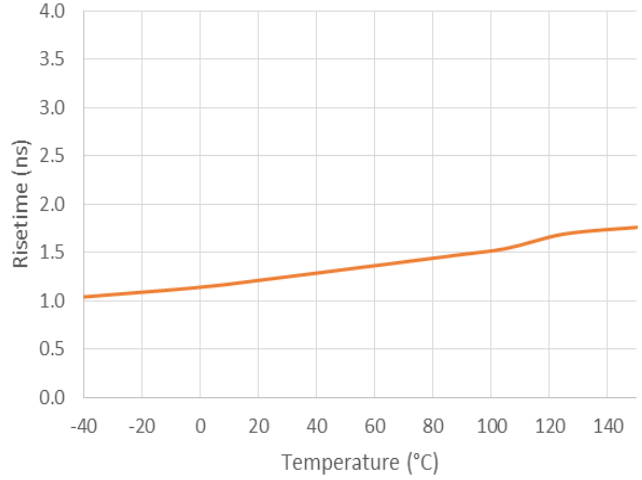

Figure 28. Switchnode 4 250 mA Load Risetime vs. Temperature

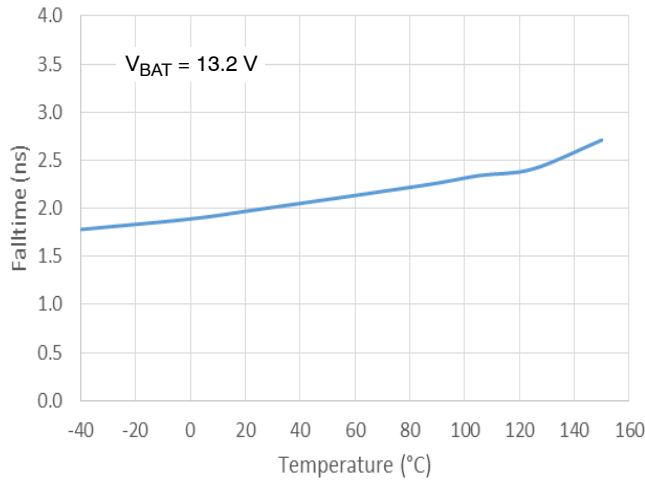

Figure 29. Switchnode 1 2.8 A Load Falltime vs. Temperature

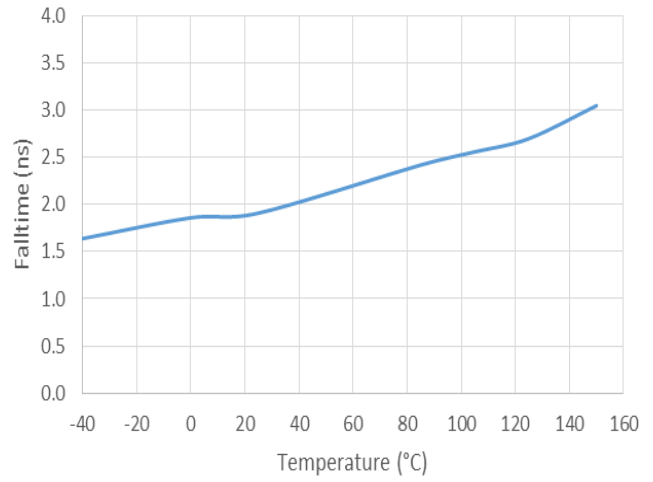

Figure 30. Switchnode 2 2.0 A Load Falltime vs. Temperature

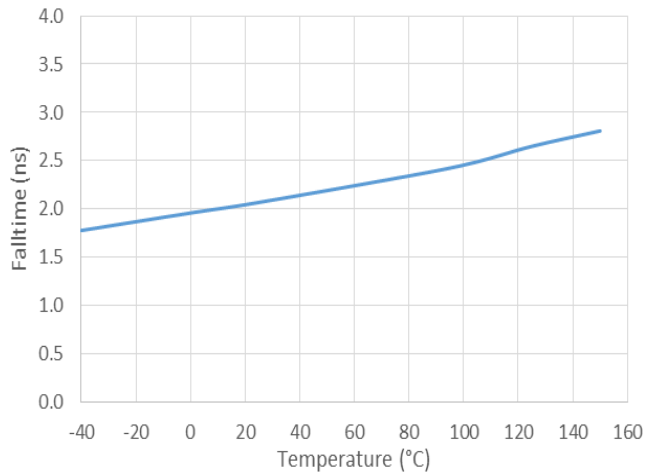

Figure 31. Switchnode 3 2.0 A Load Falltime vs. Temperature

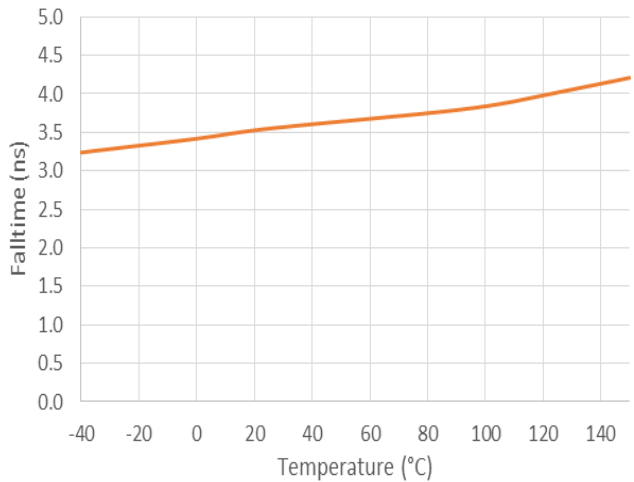

Figure 32. Switchnode 4 250 mA Load Falltime vs. Temperature

# NCV97400

## TYPICAL CHARACTERISTICS

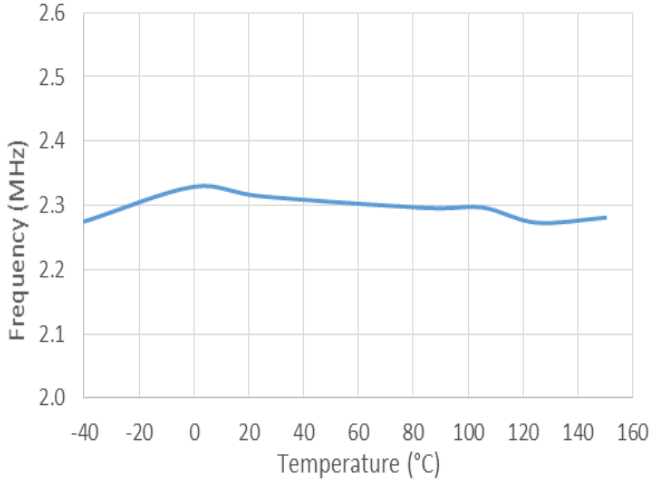

Figure 33. Switching Frequency (Spread Spectrum average) vs. Temperature

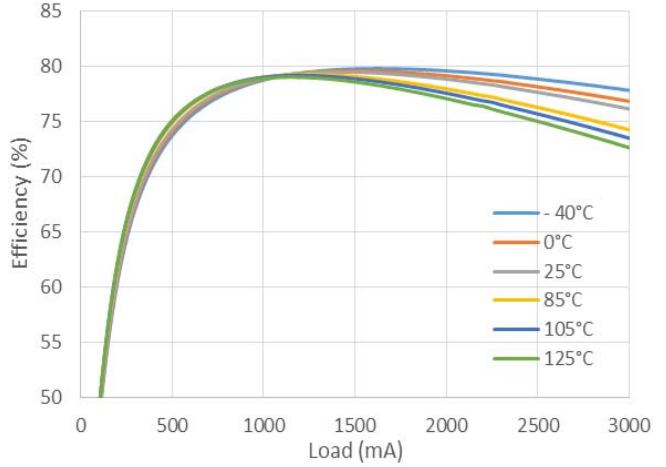

Figure 34. Switcher 1 Efficiency with  $V_{BAT} = 13.2\text{ V}$  vs. Load

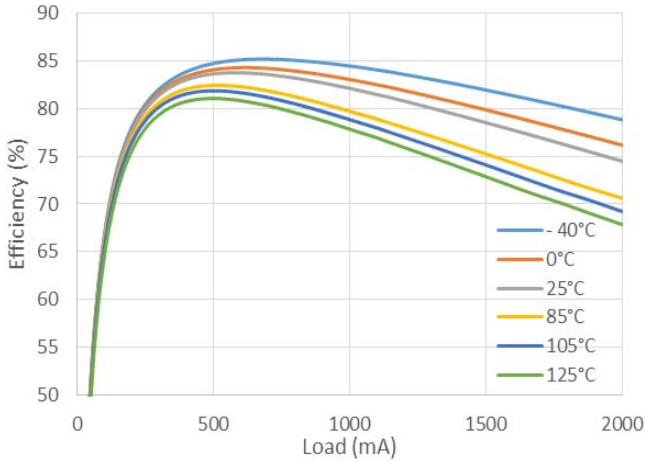

Figure 35. Switcher 2 Efficiency vs. Load  
 $V_{OUT2} = 1.8\text{ V}$

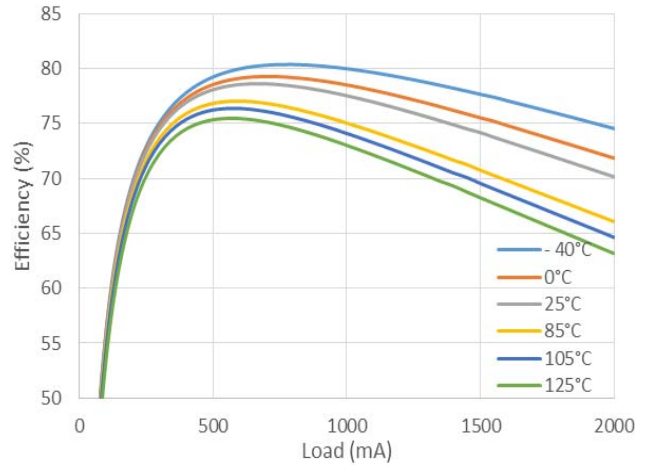

Figure 36. Switcher 3 Efficiency vs. Load  
 $V_{OUT3} = 1.2\text{ V}$

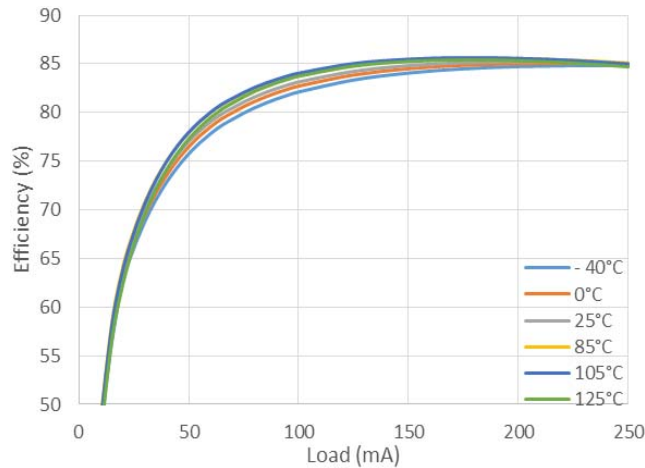

Figure 37. Switcher 4 Efficiency vs. Load

# NCV97400

## APPLICATION INFORMATION

### General Description

The NCV97400 consists of one 2 MHz battery-connected 2.5 A switcher (switcher 1) with two low-voltage 2 MHz 1.5 A switchers (switchers 2 and 3) and a downstream low-current boost converter (switcher 4).

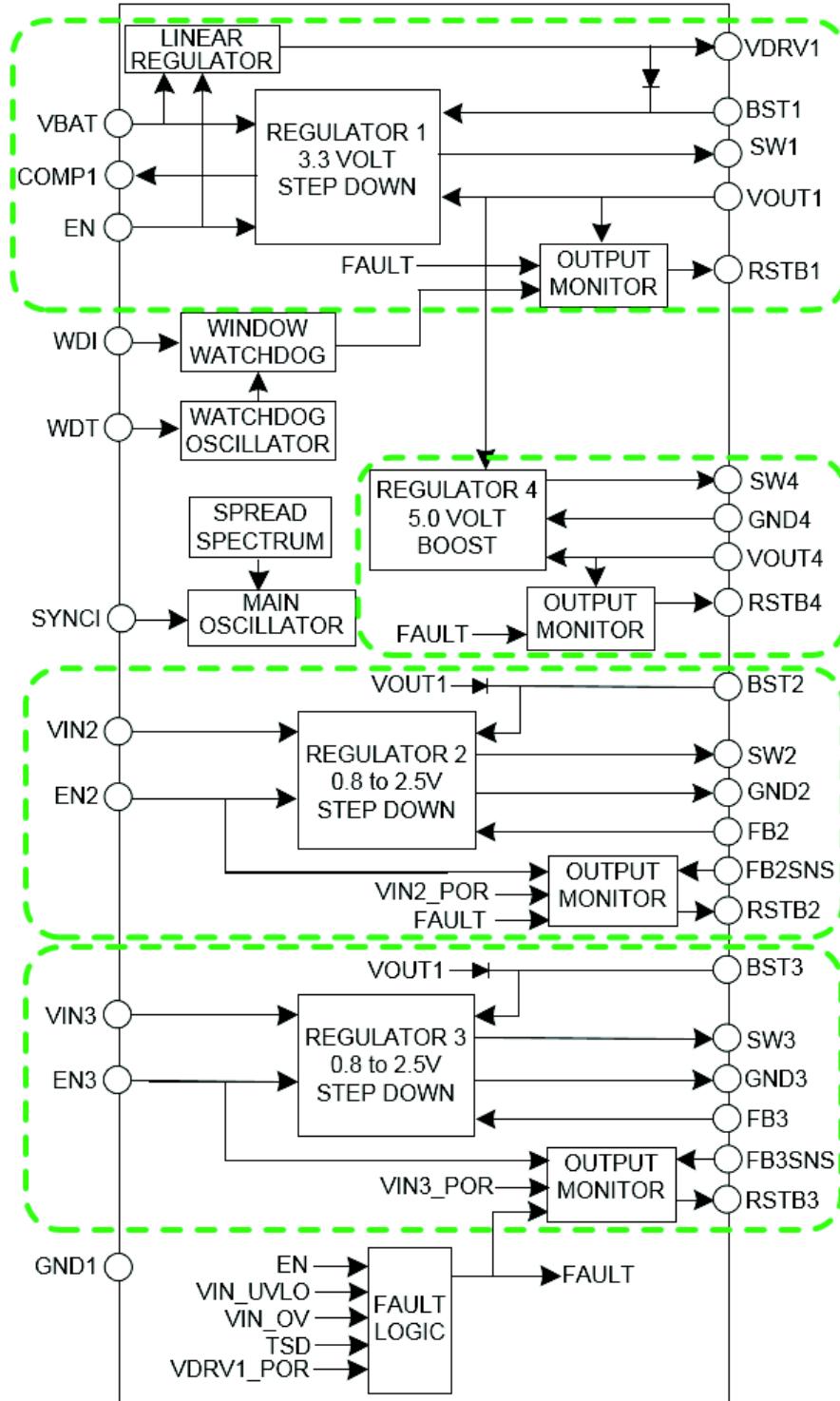

Figure 38. NCV97400 Simplified Block Diagram



**Input Voltage**

The main supply for the NCV97400 is the VBAT pin, which must always be connected to a voltage source between 4.1 V and 37 V.

- Below 4.1 V (max) an under-voltage lockout (UVLO) circuit inhibits all switching and resets the soft-start circuits.
- Above 40 V (max) an over-voltage shutdown (OVSD) circuit inhibits all switching and allows the NCV97400 to survive a 45 V load dump condition. Normal operation resumes when VBAT decreases below 34 V (min)

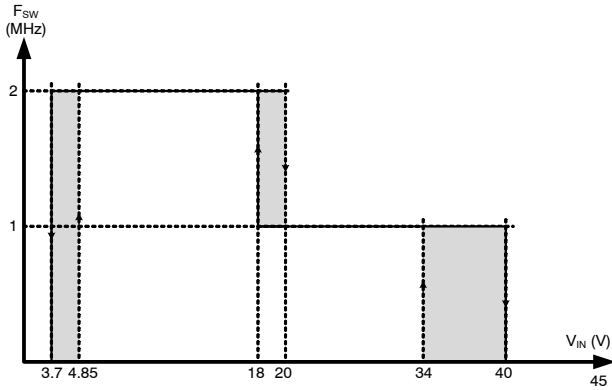

Figure 39. Input Voltage Range

**Enable and Soft-Start**

The NCV97400 can be completely disabled (shutdown mode) by connecting the master enable (EN) pin to GND. As a result, all outputs are stopped and the internal current consumption drops below 10 μA.

The EN pin is designed to accept either a logic-level signal or the battery voltage. If connecting EN to battery, and battery voltage could exceed 40 V, make the connection through a 10 k resistor. Upon receiving an input greater than 2 V, the EN pin allows switcher 1 to begin soft-start and ramp up to 3.3 V (typically in 1.4 ms). After the soft-start of VOUT1 is complete, switcher 4 (the boost regulator) begins its soft-start and ramps up to 5.0 V. Switcher 4 does not have its own enable input pin and is linked to the master enable input.

Switcher 2 and switcher 3 each have a dedicated enable input pin which can be activated a short time after the master enable is activated. Upon enabling, switcher 2 (or switcher 3) begins soft-start and ramps up the output to its final value (typically in 1.4 ms). Please note that until switcher 1 completes soft start, switcher 2 and switcher 3 are disabled internally. Figure 5 shows the startup sequence when EN, EN2, and EN3 are activated at the same time:



Figure 40. Soft Start Timing

The outputs can be sequenced automatically by connecting the ENx pins to the RSTBx pins. As an example, connect EN2 to RSTB4 and connect EN3 to RSTB2. The startup sequence will now be as in Figure 6:

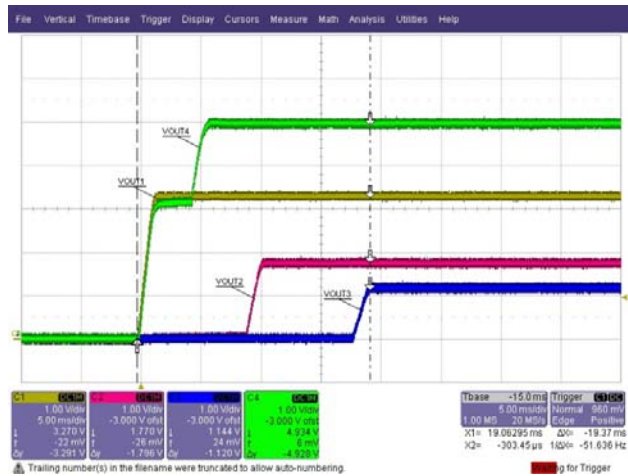

Figure 41. Soft Start Timing with Automatic Sequencing

**Oscillator**

All 4 switching regulators in the NCV97400 share the same oscillator, which, by default, operates at 2.0 MHz with pseudo-random spread spectrum (spread spectrum described in next section). The switching frequency can be controlled using the external synchronization input pin, SYNCI. Manually adjusting the switching frequency using the SYNCI pin will adjust the switching frequency for all 4 regulators since they share a common oscillator.

2 types of frequency adjustments can occur with the NCV97400: maximum duty cycle foldback and high voltage frequency foldback. These frequency foldback mechanisms take place outside the main oscillator in logic and only affect the regulators meeting the criteria. The main oscillator frequency remains unchanged.

“Maximum duty cycle foldback” is not actually an enforced frequency change, but refers to the apparent frequency if output voltage regulation causes duty cycle to reach 100% of the 2 MHz switching period – effectively skipping the OFF time for that period. When the power switch is turned off, it is always turned on again at the start of the next 2 MHz period. Due to this, the effective switching period can be multiples of the 2 MHz period. Logic monitoring duty cycle allows it to exceed 90% for up to 3 consecutive 2 MHz switching periods before enforcing a minimum OFF time at the end of the fourth period. If this occurs, the apparent frequency will be 500 kHz, and the regulator has reached maximum duty cycle. Once the load decreases (or in the case of Switcher 1, the input voltage increases), the OFF time can again be controlled by the output voltage regulator.

At high input voltages (above 20 V), switcher 1 frequency folds back to 1 MHz operation to properly maintain the output voltage when the conversion ratio needs to be lower than the minimum on time allows at 2 MHz operation. Once the input voltage drops back below 18 V, 2 MHz operation will resume. The switching frequency of switchers 2, 3 and 4 are unaffected by high VBAT voltage.

**Spread Spectrum**

In SMPS devices, switching translates to higher efficiency and switching at high frequency can reduce the size of external components. Unfortunately, switching also leads to a higher EMI profile. Spread spectrum is a method used to reduce the peak electromagnetic emissions of a switching regulator.

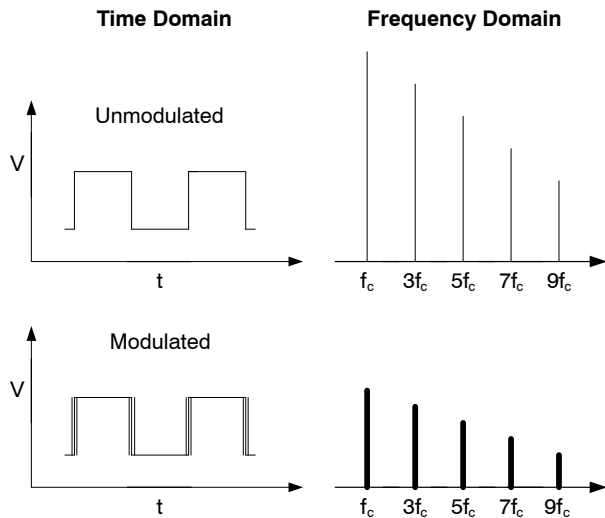

**Figure 42. Spread Spectrum Comparison**

The NCV97400 includes built-in spread spectrum in order to reduce peak radiated emissions. The NCV97400 uses a pseudo-random generator to sequence the oscillator frequency between the base frequency and a maximum spread spectrum frequency (shown in the table below). Frequencies are each offset by 40 kHz. Over time, each

frequency is used an equal number of times in order to ensure an even spread of the energy into the wider band, and reduces the peak energy at the base frequency.

**Table 4. PSEUDO-RANDOM FREQUENCY BINS**

Pseudo Random Bin	Switching Frequency
0000	2.00 MHz
0001	2.04 MHz
0010	2.08 MHz
0011	2.12 MHz
0100	2.16 MHz
0101	2.20 MHz
0110	2.24 MHz
0111	2.28 MHz
1000	2.32 MHz
1001	2.36 MHz
1010	2.40 MHz
1011	2.44 MHz
1100	2.48 MHz
1101	2.52 MHz
1110	2.56 MHz
1111	2.60 MHz

The period of each switch cycle will change inversely to the switching frequency but the duty cycle will remain constant to properly maintain the output.

**EMI and Input Filter**

In addition to spread spectrum, an input filter is recommended to further reduce emissions due to switching heavy loads.

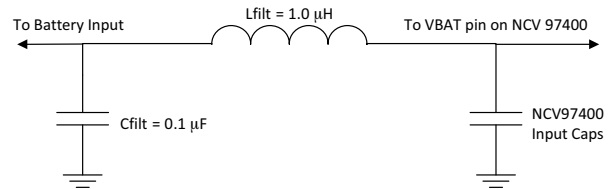

**Figure 43. LC Input Filter**

When connecting the battery voltage to other circuits on the PCB, be sure to connect them to the battery input side, not the NCV97400 side, of the LC filter. This will give the best possible noise performance.

**Current Limit and Short Circuit Frequency Foldback**

Each switching regulator has a peak current limit to protect the inductor and downstream components in case of a short circuit or transient event. Due to the ripple current through the inductor, the maximum dc output current of each converter is lower than the peak current limit. If the peak current limit is reached during the switch cycle, the switch turns off for the remainder of the cycle and turns on again at the start of the next cycle.

During severe output overloads or short circuit conditions, the primary regulator (switcher 1) automatically reduces its switching frequency and enters analog foldback. This creates a duty cycle small enough to limit the power in the output components while maintaining the ability to automatically reestablish the output voltage if the overload is removed. This foldback changes the main oscillator and will apply to all 4 regulators. Once the overload or short circuit is removed, 2 MHz operation will resume.

If the output current is still too high (after short circuit frequency foldback for switcher 1 or after peak current limit is reached for switchers 2, 3, and 4), the overloaded regulator may automatically enter an auto-recovery burst mode (hiccup mode) to self-protect and further reduce dissipated power in the output components. When an overload is detected, the switcher disables its output, remains off for the hiccup time, and then goes through the power-on reset procedure. If the overload has been removed, the output re-enables and operates normally. If the short is still present, the cycle begins again until the short is removed. Hiccup mode is continuous at a typical rate of 32 kHz until the short is removed.

**External Frequency Synchronization**

The NCV97400 can be synchronized to an external clock signal. If the IC does not have its switching frequency controlled by the SYNCI input, it operates normally at the default switching frequency, typically 2.0 MHz with spread spectrum.

The SYNCI pin is used as a synchronization input during normal operation and is ignored during startup, shutdown, overvoltage, and other transient conditions. When the switching frequency is controlled by the SYNCI input, synchronization starts within 2 ms of soft start completion. Please keep in mind that spread spectrum will be disabled when the oscillator is being synchronized with an external clock.

A rising edge on the SYNCI pin causes the current oscillator period to end and a new period to start. The switchnode of switcher 1 goes high 90 ns after a SYNCI rising edge, and the switchnode of switcher 4 goes low 350 ns after a SYNCI rising edge. If another rising edge does not arrive at the SYNCI pin within the Master Reassertion time, the NCV97400 resumes with the default switching frequency. This allows for uninterrupted operation in the event that the external clock is turned off.

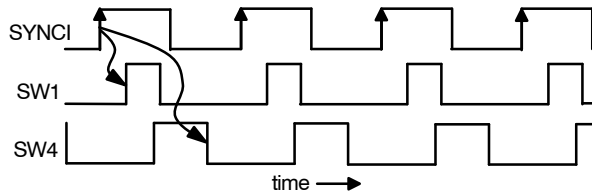

Figure 44. External Synchronization Timing

**Reset & Delay**

When the voltage on the VOUTx pin (or FBxSNS pin for SW2 and SW3) drops below or goes above the reset threshold, the corresponding open-drain output RSTBx is asserted (pulled low). All RSTBx outputs are also asserted during VBAT overvoltage and undervoltage faults, and during thermal shutdown. The RSTB2 & RSTB3 pins are also asserted (pulled low) when the associated switcher is disabled, and RSTB1 is asserted in response to a Watchdog Fault.

Each of the RSTB signals can either be used as a reset with delay or as a power good (no delay). The delay is determined by the current into the RSTBx pin, set by a resistor, show in Figure 45, below.

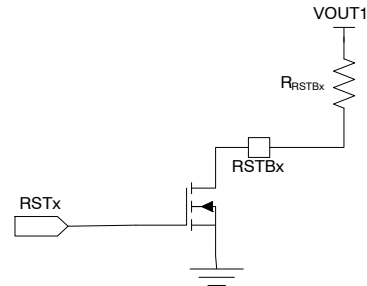

Figure 45. Reset Delay Circuit

Use the following equation to determine the ideal reset delay time using currents less than 500 μA:

$$t_{\text{delay}} = \frac{2475}{I_{\text{RSTBx}}}$$

where:

$t_{\text{delay}}$ : ideal reset delay time [ms]

$I_{\text{RSTBx}}$ : current into the RSTBx pin [μA]

Using  $I_{\text{RSTBx}} = 1 \text{ mA}$  removes the delay and allows the reset to function as a “power good” pin.

The RSTBx resistor is commonly tied to VOUT1. Typical delay times for a 3.3 V pull-up can be achieved with the following resistor values:

**Table 5. RESET DELAY TIMES**

R_RSTBx (kΩ)	t_DLY (ms)
3.3	0
6.6	5
10	7.5
15	11.3
20	15.0
25	18.8
33	24.8

**Functional Safety**

The NCV97400 has been developed according to ISO-26262 targeting ASIL B/C applications. With this in mind, we've specifically included the following items to make this power supply compatible with your safety application:

1. There are 2 independent bandgaps for the internal reference voltages. The primary bandgap is used for the internal supplies and the regulation of each power supply output. The second bandgap is primarily used as a safety mechanism as a reference to which the RSTBx circuits are compared.
2. Each output voltage has a separate window voltage monitoring circuit that's comparing the output feedback signal to the internal reference generated by the second bandgap. Each output voltage is monitored for overvoltage and undervoltage conditions. Please see "Reset & Delay" for more details.
3. A window watchdog is included to monitor an incoming watchdog signal from a microcontroller. This behavior is detailed in the "Watchdog" section.

**Watchdog**

The 97400 contains a window watchdog function, which is exclusively tied to the RSTB1 output 1 of the PMIC. The watchdog function requires the microcontroller to send a pulse to show that it's still active. The watchdog oscillator runs independently of the switching oscillator. Window watchdog is active when SW1 is in regulation and RSTB1 is high. It is inactive when SW1 is out of regulation and RSTB1 is low. Watchdog timeout trigger mode with long timing begins on the rising edge of RSTB1. If no watchdog pulse is received during the timeout time  $t_{WD\_timeout}$ , RSTB1 is pulled low for the delay time,  $t_{RESET}$ , and the watchdog timeout time starts again.

$$t_{WD\_timeout}(ms) = 2.81 \times C\_WDT(pF) + 18$$

Once a successful watch pulse is received on the WDI pin, a closed window time,  $t_{WD\_CLS}$ , is in effect. If a pulse is received on the WDI pin during this time, RSTB1 is asserted. During normal operation, a successful watchdog pulse is required on the WDI pin during the watchdog window time,  $t_{WD}$ , but not during the closed window time,  $t_{WD\_CLS}$ . If a valid watchdog pulse is not received on the WDI pin, RSTB1 is pulled low to signal the fault. Once the RSTB1 signal is released, the watchdog will start again and the watchdog timeout time,  $t_{WD\_timeout}$ , begins again. VOUT1 is not affected by the watchdog circuitry and will remain in regulation during a watchdog fault.

In the event that the WDI pin is held high and no pulse is received for the duration of the watchdog timeout time or for the watchdog window time, RSTB1 is pulled low to signal the fault. Once the RSTB1 signal is released, the watchdog may start again and resumes the normal watchdog window time.

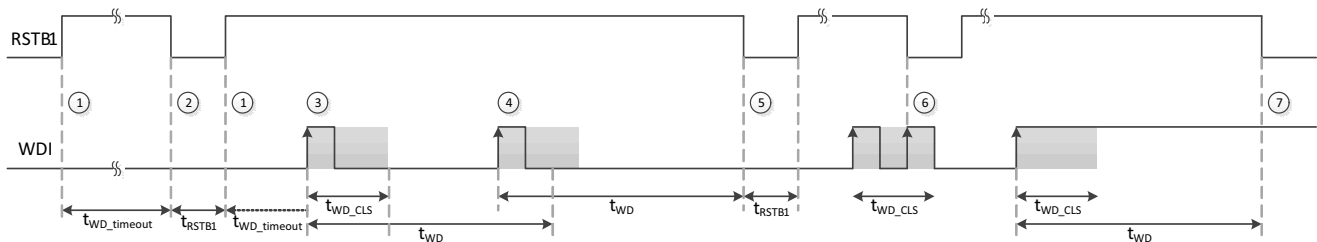

**Figure 46. Watchdog Function and Timing**

1. Rising edge on RSTB1 triggers the start of watchdog timeout mode.
2. No watchdog trigger within the watchdog timeout time  $t_{WD\_timeout}$ . RSTB1 pulled low.
3. Window trigger mode active after rising edge on the WDI pin.
4. First successful watchdog trigger within the window time  $t_{WD}$ .
5. Watchdog trigger failed, no rising edge at WDI pin within window time  $t_{WD}$ . RSTB1 pulled low.
6. Watchdog trigger failed, rising edge at WDI pin within boundary time  $t_{WD\_CLS}$ . RSTB1 pulled low.
7. Watchdog trigger failed, signal at WDI pin permanent high. RSTB1 pulled low.

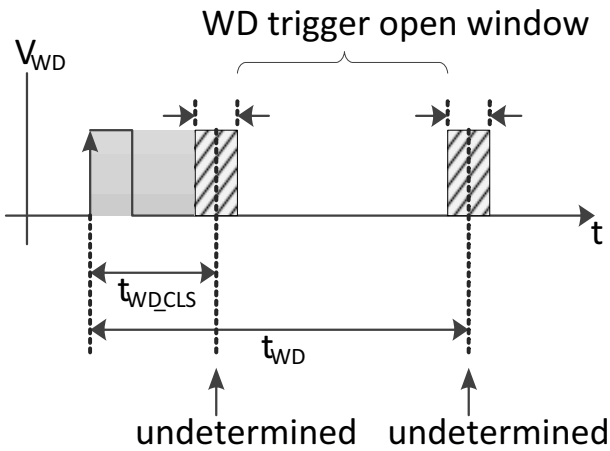

Figure 47. Watchdog Window with Tolerances

**Debug Mode**

The NCV97400 includes a user selectable “debug mode” that disables spread spectrum and the watchdog to make it easier to take certain measurements during evaluation. While the watchdog is disabled, it is unable to assert a fault on the RSTB1 signal.

To enter and remain in debug mode, connect the WDT pin to GND and connect the SYNCI pin high (a voltage greater than 2 V). If either of these 2 criteria are not met, the NCV97400 will resume normal operation. Further, if the WDT pin is held low while the SYNCI is not held high, a fault will be triggered on RSTB1.

**SWITCHER 1**

The primary dc–dc output for the NCV97400 is 3.3 V, set by an internal resistor divider. This buck regulator is non–synchronous and requires an external low–side freewheeling diode to operate.

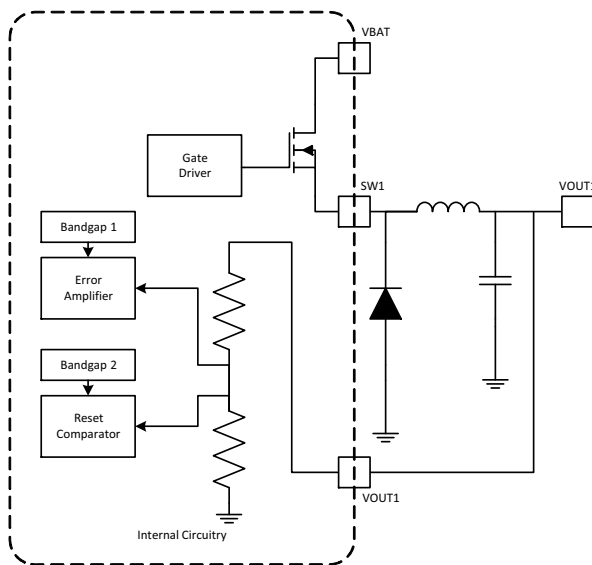

Figure 48. Switcher 1 Block Diagram

Internally, connected to the VOUT1 pin, the primary feedback regulates the output and the secondary path compares to the second reference for the reset circuitry.

The EN pin controls the enable circuitry for the switcher 1 output. It can accept a logic–level input and is also capable of high voltages and can be connected directly to VBAT.

**Error Amplifier**

Switcher 1 uses a transconductance type error amplifier. The output voltage of the error amplifier controls the peak inductor current at which the power switch shuts off. The Current Mode control method employed allows the use of a simple, type II compensation to optimize the dynamic response according to system requirements.

The compensation components must be connected between the output of the error amplifier and the electrical ground (between pins COMP1 and GND). For most applications, the following compensation circuitry is recommended:

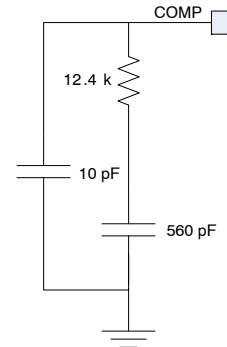

Figure 49. Recommended Compensation for Switcher 1

**Slope Compensation**

A fixed slope compensation signal is generated internally and added to the sensed current to avoid increased output voltage ripple due to bifurcation of inductor ripple current at duty cycles above 50% (sub–harmonics oscillations). The fixed amplitude of the slope compensation signal requires the inductor to be greater than a minimum value in order to avoid sub–harmonic oscillations. For the 3.3 V output, the recommended inductor value is between 2.2 μH and 4.7 μH.

To determine the minimum inductor required to avoid sub–harmonic oscillations, please refer to the following equation:

$$L_{min} = \frac{V_{OUT}}{2 \cdot S_{ramp}}$$

where:

$L_{min}$ : minimum inductor required to avoid sub–harmonic oscillations [μH]

$V_{OUT}$ : output voltage [V]

$S_{ramp}$ : internal slope compensation [A/μs]



**Drive and Bootstrap**

At the DRV1 pin an internal regulator provides a ground-referenced voltage to an external capacitor ( $C_{DRV1}$ ), to allow fast recharge of the external bootstrap capacitor ( $C_{BST1}$ ) used to supply power to the power switch gate driver. If the voltage at the DRV1 pin goes below the DRV1 POR Threshold  $V_{DRV1SP}$  switching is inhibited and the soft-start circuit is reset, until the DRV1 pin voltage goes back up above  $V_{DRV1ST}$ .

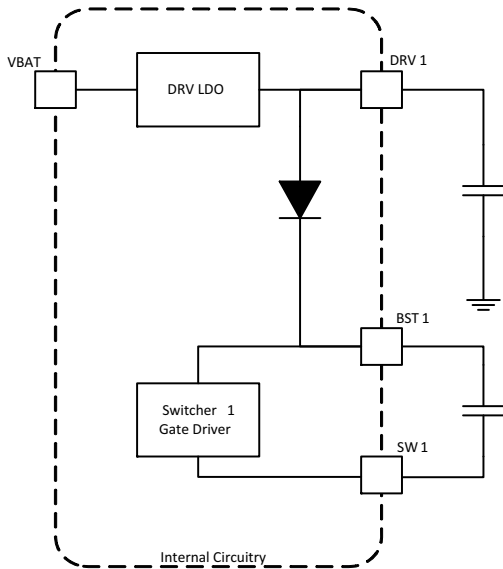

**Figure 50. Switcher 1 Drive and Bootstrap Circuitry**

In order for the bootstrap capacitor to stay charged, the switch node needs to be pulled down to ground regularly. In very light load condition, when switcher 1 skips switching cycles to keep the output voltage in regulation, the bootstrap voltage could collapse and the regulator stop switching. To prevent this, an approximately 10 mA internal load is connected on VOUT1 to operate correctly in all cases. When the NCV97200 is enabled and VBAT is below approximately 7.5 V, the internal load is increased to approximately 60 mA.

A fast-charge circuit ensures the bootstrap capacitor is always charged prior to starting the switcher after it has been enabled.

**Soft Start**

Upon being enabled or released from a fault condition, and after the DRV1 voltage is established, a soft-start circuit ramps the switching regulator error amplifier reference voltage to the final value. During soft-start, the average switching frequency is lower than its normal mode value until the output voltage approaches regulation.

**Current Limit**

Due to the ripple on the inductor current, the average output current of a buck converter is lower than the peak current set point of the regulator. Figure 51 shows – for a 4.7  $\mu\text{H}$  inductor – how the variation of inductor peak current with input voltage affects the maximum DC current switcher 1 can deliver to a load. Figure 52 shows the same for 2.2  $\mu\text{H}$  inductor.

Internal slope compensation  $S_{ramp1}$  also reduces switcher 1 peak current limit proportional to the duty cycle. The amount of this reduction for switcher 1 is the product of  $S_{ramp1}$ , switching period, and 3.3 divided by VBAT.

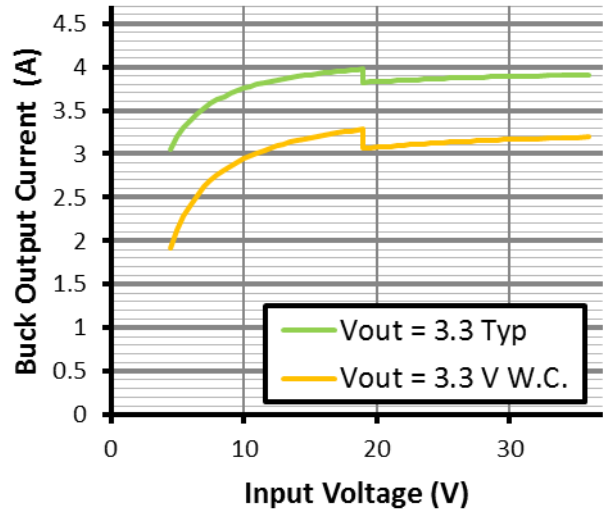

**Figure 51. Switcher 1 Dc Output Current vs. VIN with a 4.7  $\mu\text{H}$  Inductor**

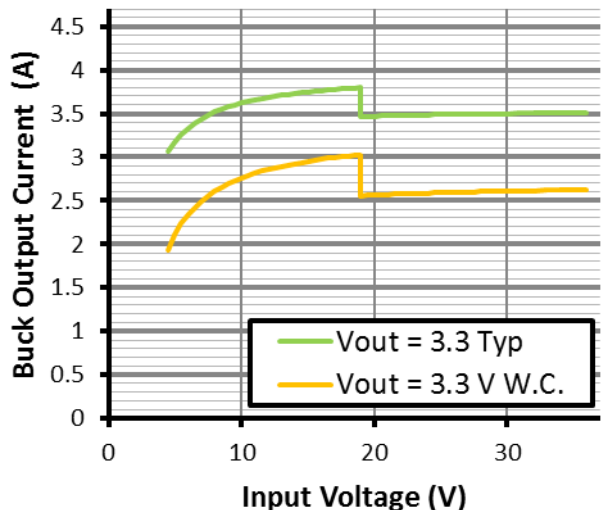

**Figure 52. Switcher 1 Dc Output Current vs. VIN with a 2.2  $\mu\text{H}$  Inductor**

**High Voltage Frequency Foldback**

To limit the power lost in generating the drive voltage for the power switch, the switching frequency is reduced by a factor of 2 when the input voltage exceeds the  $V_{BAT}$  Frequency Foldback Threshold  $V_{FLIU}$  (see Figure 53) Frequency reduction is automatically terminated when the input voltage drops back below the  $V_{BAT}$  Frequency Foldback threshold  $V_{FLID}$ .

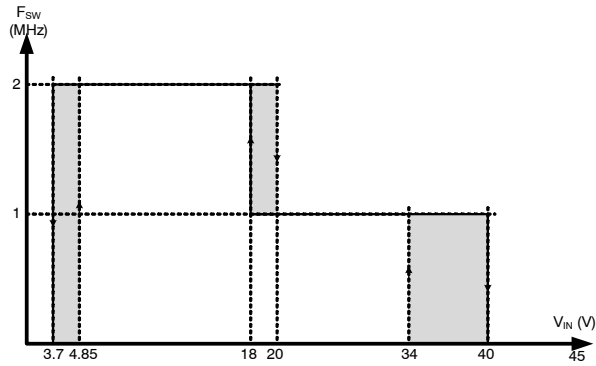

**Figure 53. High Voltage Frequency Foldback**

**Inductor Selection**

A 3.3  $\mu\text{H}$  inductor is recommended for Switcher 1, although values between 2.2  $\mu\text{H}$  and 4.7  $\mu\text{H}$  may give more optimized performance in some applications. The relationship between several operating parameters are given by the equation below.

$$L = \frac{V_{OUT} \left( 1 - \frac{V_{OUT}}{V_{IN,max}} \right)}{\Delta I_r \cdot f_{sw} \cdot I_{OUT}}$$

where:

- $V_{OUT}$ : dc output voltage [V]
- $V_{IN,max}$ : maximum dc input voltage [V]
- $\Delta I_r$ : inductor current ripple [%]
- $f_{sw}$ : switching frequency [Hz]
- $I_{OUT}$ : dc output current [A]

**Discontinuous Mode**

The regulator operates in Continuous Conduction Mode (CCM) when average inductor current exceeds half the peak-to-peak ripple current, and in Discontinuous Conduction Mode (DCM) when it does not. The borderline between these modes can be found using the following equation:

$$I_{BCM} = \frac{1}{2} \cdot \frac{\left( 1 - \frac{V_{OUT}}{V_{IN,max}} \right) \cdot V_{OUT}}{f_{sw} \cdot L}$$

where:

- $I_{BCM}$ : borderline conduction mode output current [A]
- $V_{OUT}$ : dc output voltage [V]
- $V_{IN,max}$ : maximum dc input voltage [V]

$f_{sw}$ : switching frequency [Hz]

$L$ : inductor value [H]

Average output currents above IBCM will cause operation in CCM while average output currents below IBCM will cause operation in DCM.

**SWITCHERS 2 AND 3**

The secondary dc-dc outputs (switcher 2 and switcher 3) for the NCV97400 are adjustable down to 0.8 V and can each be set by an external resistor divider. These buck regulators are synchronous and both high-side and low-side switches are internal to the IC. As an example: please see the following diagram for the switcher 2 architecture:

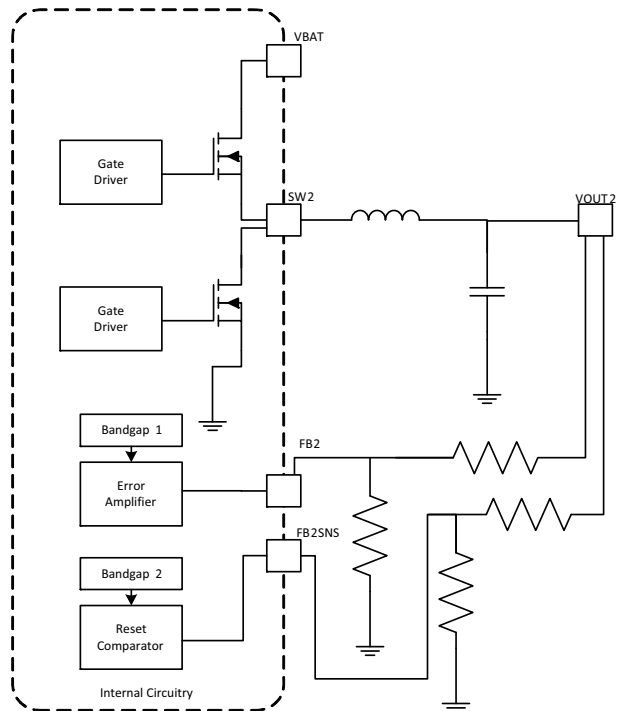

**Figure 54. Switcher 2 Block Diagram**

Since the output for switcher 2 is adjustable, the resistor divider is external and the primary feedback node, FB2, is monitored internally and compared to the reference for proper output regulation. The secondary external resistor divider, connected to FB2SNS, is monitored internally by the reset circuitry and compared to the second reference. When not using the NCV97400 in a safety application, you may use one resistor divider and directly connect FB2SNS to FB2. There is a similar set of pins for switcher 3.

The EN2 pin controls the enable circuitry for the switcher 2 output. It can accept a logic-level input and is sometimes connected to VOUT1 or to RSTB1. The EN3 pin controls switcher 3 in the same way. Both EN2 and EN3 are disabled internally when the primary enable input, EN, is pulled low.

If the voltage at the VIN2 or the VIN3 pin goes below the VIN2 (or VIN3) POR Threshold  $V_{INxSB}$ , switching is inhibited and the soft-start circuit is reset, until the VIN2 (or VIN3) pin voltage goes back up above  $V_{INxST}$ .

**Error Amplifier**

Switchers 2 & 3 each use a voltage type error amplifier. The compensation for these regulators is internal and cannot be adjusted.

**Slope Compensation**

A fixed slope compensation signal is generated internally and added to the sensed current to avoid increased output voltage ripple due to bifurcation of inductor ripple current at duty cycles above 50% (sub-harmonics oscillations). The fixed amplitude of the slope compensation signal requires the inductor to be greater than a minimum value, depending on output voltage, in order to avoid sub-harmonic oscillations. For a 1.2 V output, for example, the recommended inductor value is 1.0 μH.

To determine the minimum inductor required to avoid sub-harmonic oscillations, please refer to the following equation:

$$L_{min} = \frac{V_{OUT}}{2 \cdot S_{ramp}}$$

where:

- L<sub>min</sub>: minimum inductor required to avoid sub-harmonic oscillations [μH]
- V<sub>OUT</sub>: output voltage [V]
- S<sub>ramp</sub>: internal slope compensation [A/μs]

**Bootstrap**

Since the internal high-side FET gate drivers are low voltage, BST2 and BST3 are connected through internal diodes to the VOUT1 pin (see Figure 1). Connection of a 0.1 uF capacitor from VOUT1 to ground close to the VOUT1 pin is recommended in order to allow fast recharge of the external bootstrap capacitor (C<sub>BST2</sub> and C<sub>BST3</sub>) used to supply power to the power switch gate driver.

**Soft Start**

Upon being enabled or released from a fault condition, and after the VIN2 (or VIN3) voltage is established (and once switcher 1 has completed soft start), a soft-start circuit ramps the switching regulator error amplifier reference voltage to the final value. The typical soft-start duration is 1.4 ms.

**Current Limit**

Due to the ripple on the inductor current, the average output current of a buck converter is lower than the peak current set point of the regulator. Table 6 shows some examples of common setups:

**Table 6. SW2&3 WORST CASE DC OUTPUT CURRENT**

Output Voltage (V)	Inductor Value (μH)	Worst Case Max Dc Output (A)	Typical Max Dc Output (A)
2.5	2.2	0.8	1.6
1.8	1.5	1.1	1.9
1.2	1.0	1.4	2.0
0.8	1.0	1.6	2.2

**Output Voltage Selection**

The voltage outputs for switcher 2 and switcher 3 are adjustable and can be set with an external resistor divider. The feedback reference for both switchers is 0.8 V.

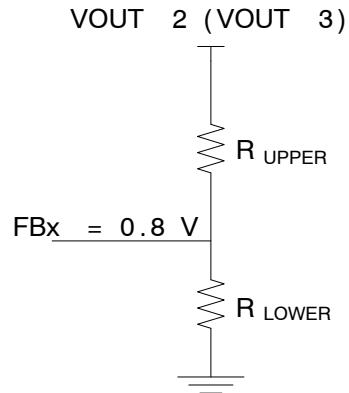

**Figure 55. Output Voltage Selection with Feedback Divider**

The upper resistor should typically be 10 kΩ and is part of the internal feedback loop. To maintain stability over all conditions, it is recommended to only change the lower feedback resistor to set the output voltage. Use the following equation:

$$R_{LOWER}(k\Omega) = \frac{8}{V_{OUT} - 0.8}$$

Some common setups are listed below:

Desired Output (V)	V <sub>REF</sub> (V)	R <sub>UPPER</sub> (kΩ, 1%)	R <sub>LOWER</sub> (kΩ, 1%)
0.8	0.8	10.0	NP
0.9	0.8	10.0	80.6
1.2	0.8	10.0	20.0
1.8	0.8	10.0	8.06
2.5	0.8	10.0	4.75

For safety applications, please be sure to use a second, parallel, feedback divider and connect the feedback to FBxSNS. This provides isolation between the 2 distinct feedback paths. For applications that don't require isolated feedback paths, you may short the FBxSNS pin directly to the FBx pin of the respective switcher.



**Inductor Selection**

By default, the following inductor values are recommended for the switchers 2 and 3, based on output voltage:

Output Voltage	Inductor Value
0.8 V	1.0 μH
1.2 V	1.0 μH or 1.2 μH
1.5 V	1.5 μH or 2.2 μH
1.8 V	1.5 μH or 2.2 μH
2.5 V	2.2 μH or 3.3 μH

If you'd like to choose a different value, please follow the equation, below.

$$L = \frac{V_{OUT} \left( 1 - \frac{V_{OUT}}{V_{IN,max}} \right)}{\Delta I_r \cdot f_{sw} \cdot I_{OUT}}$$

where:

- V<sub>OUT</sub>: dc output voltage [V]
- V<sub>IN,max</sub>: maximum dc input voltage [V]
- ΔI<sub>r</sub>: inductor current ripple [%]
- f<sub>sw</sub>: switching frequency [Hz]
- I<sub>OUT</sub>: dc output current [A]

**Noise Performance for Heavy Load**

For heavy load conditions (> 1 A) on the downstream switching outputs, a snubber circuit is recommended for improved noise performance. The following circuit can be used for all output voltage combinations:

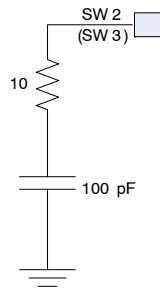
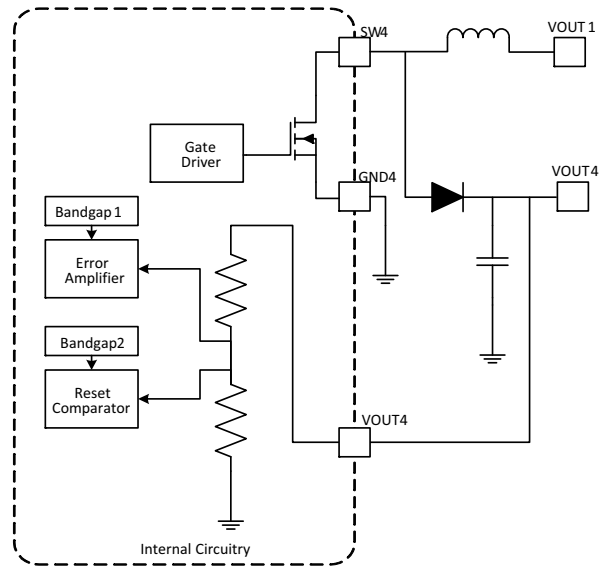

**Figure 56. RC Snubber for Noise Performance at Heavy Load**

In order to minimize noise on the Switcher 2 & Switcher 3 inputs (VOUT1), Switcher 3 switches in-phase with Switcher 1, and Switcher 2 switches out-of-phase with Switcher 1.

**SWITCHER 4**

The NCV97400 contains a boost regulator, switcher 4, which boosts the 3.3 V from the switcher 1 to 5.0 V. This non-synchronous boost regulator requires an external freewheeling diode. Switcher 4 is intended to be used for in-vehicle networks (e.g. CAN) and can supply up to 250 mA dc.



**Figure 57. Switcher 4 Block Diagram**

Internally, connected to the VOUT4 pin, the primary feedback regulates the output and the secondary path compares to the second reference for the reset circuitry.

The EN pin controls the enable circuitry for the switcher 4 output. Once switcher 1 has completed soft-start and the output is in regulation, switcher 4 is automatically enabled.

**Error Amplifier**

Switcher 4 uses a voltage type error amplifier. The compensation for this regulator is internal and cannot be adjusted.

**Soft Start**

Upon being enabled or released from a fault condition, and once switcher 1 has completed soft start, a soft-start circuit ramps the switcher 4 error amplifier reference voltage to the final value.

Please note that since this is a boost regulator, the VOUT4 output will be a diode voltage below VOUT1 until it starts switching in regulation. This is normal behavior – please see the scope capture below:



**Figure 58. Switcher 4 Soft-start**

# NCV97400

## Current Limit

Due to the ripple on the inductor current, the average output current of the boost converter is lower than the peak current set point of the regulator. Table 7 shows some examples of common setups.

**Table 7. SW4 WORST CASE DC OUTPUT CURRENT**

Output Voltage (V)	Inductor Value (uH)	Worst Case Max Dc Output (mA)	Typical Max Dc Output (mA)
5.0	4.7	300	375
5.0	2.2	250	325

## ORDERING INFORMATION

Device	Package	Shipping†
NCV97400MW00R2G	QFN32 (Pb-Free)	5000 / Tape & Reel

†For information on tape and reel specifications, including part orientation and tape sizes, please refer to our Tape and Reel Packaging Specifications Brochure, BRD8011/D.

# MECHANICAL CASE OUTLINE

## PACKAGE DIMENSIONS

ON Semiconductor®

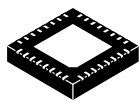

1 32

SCALE 2:1

QFNW32 5x5, 0.5P  
CASE 484AB  
ISSUE D

DATE 07 SEP 2018

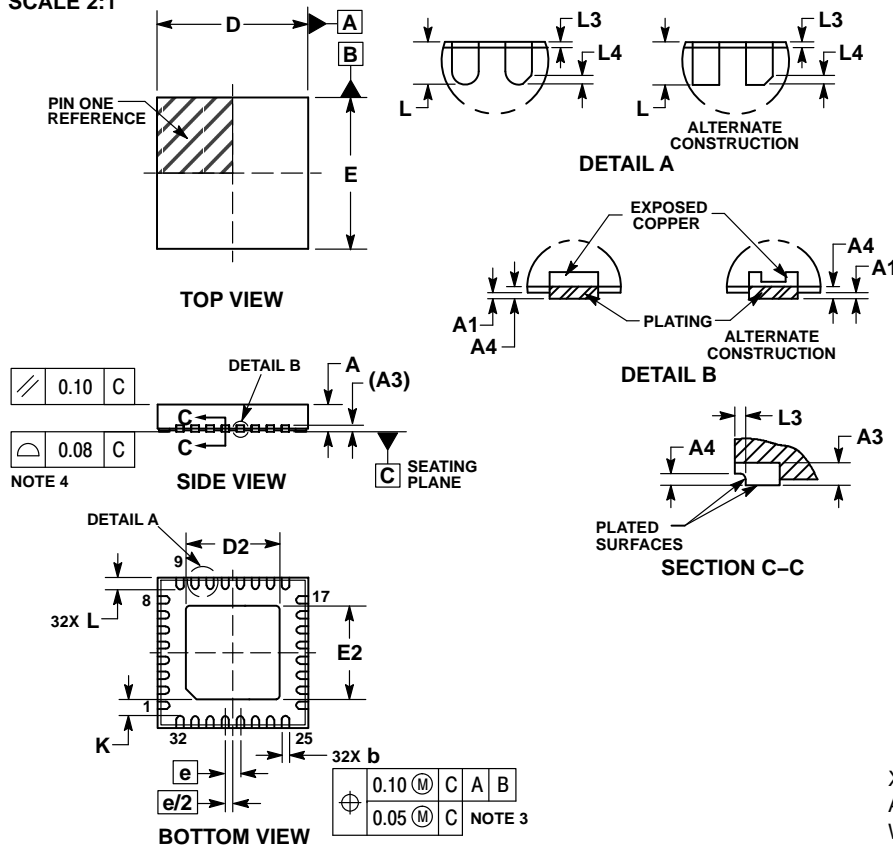

NOTES:

1. DIMENSIONS AND TOLERANCING PER ASME Y14.5M, 1994.
2. CONTROLLING DIMENSION: MILLIMETERS.
3. DIMENSION b APPLIES TO PLATED TERMINAL AND IS MEASURED BETWEEN 0.10 AND 0.20MM FROM THE TERMINAL TIP.
4. COPLANARITY APPLIES TO THE EXPOSED PAD AS WELL AS THE TERMINALS.

MILLIMETERS			
DIM	MIN	NOM	MAX
A	0.80	0.90	1.00
A1	---	---	0.05
A3	0.20 REF		
A4	0.10	---	---
b	0.20	0.25	0.30
D	4.90	5.00	5.10
D2	3.00	3.10	3.20
E	4.90	5.00	5.10
E2	3.00	3.10	3.20
e	0.50 BSC		
K	0.35	---	---
L	0.30	0.40	0.50
L3	---	---	0.10
L4	0.08 REF		

GENERIC MARKING DIAGRAM\*

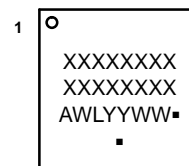

- XXXXX = Specific Device Code
- A = Assembly Location
- WL = Wafer Lot
- YY = Year
- WW = Work Week
- = Pb-Free Package

(Note: Microdot may be in either location)

\*This information is generic. Please refer to device data sheet for actual part marking. Pb-Free indicator, "C" or microdot "▪", may or may not be present. Some products may not follow the Generic Marking.

RECOMMENDED SOLDERING FOOTPRINT\*

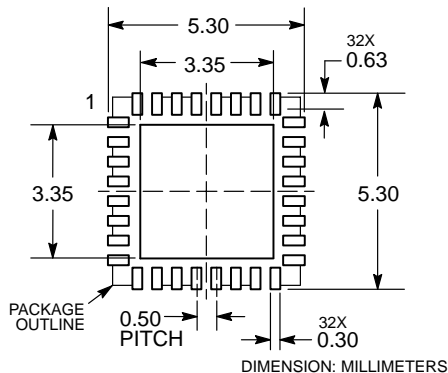

\*For additional information on our Pb-Free strategy and soldering details, please download the ON Semiconductor Soldering and Mounting Techniques Reference Manual, SOLDERRM/D.

DOCUMENT NUMBER:	98AON14940G	Electronic versions are uncontrolled except when accessed directly from the Document Repository. Printed versions are uncontrolled except when stamped "CONTROLLED COPY" in red.
DESCRIPTION:	QFNW32 5x5, 0.5P	PAGE 1 OF 1

ON Semiconductor and ON are trademarks of Semiconductor Components Industries, LLC dba ON Semiconductor or its subsidiaries in the United States and/or other countries. ON Semiconductor reserves the right to make changes without further notice to any products herein. ON Semiconductor makes no warranty, representation or guarantee regarding the suitability of its products for any particular purpose, nor does ON Semiconductor assume any liability arising out of the application or use of any product or circuit, and specifically disclaims any and all liability, including without limitation special, consequential or incidental damages. ON Semiconductor does not convey any license under its patent rights nor the rights of others.

**onsemi**, **Onsemi**, and other names, marks, and brands are registered and/or common law trademarks of Semiconductor Components Industries, LLC dba "**onsemi**" or its affiliates and/or subsidiaries in the United States and/or other countries. **onsemi** owns the rights to a number of patents, trademarks, copyrights, trade secrets, and other intellectual property. A listing of **onsemi**'s product/patent coverage may be accessed at [www.onsemi.com/site/pdf/Patent-Marking.pdf](http://www.onsemi.com/site/pdf/Patent-Marking.pdf). **onsemi** reserves the right to make changes at any time to any products or information herein, without notice. The information herein is provided "as-is" and **onsemi** makes no warranty, representation or guarantee regarding the accuracy of the information, product features, availability, functionality, or suitability of its products for any particular purpose, nor does **onsemi** assume any liability arising out of the application or use of any product or circuit, and specifically disclaims any and all liability, including without limitation special, consequential or incidental damages. Buyer is responsible for its products and applications using **onsemi** products, including compliance with all laws, regulations and safety requirements or standards, regardless of any support or applications information provided by **onsemi**. "Typical" parameters which may be provided in **onsemi** data sheets and/or specifications can and do vary in different applications and actual performance may vary over time. All operating parameters, including "Typicals" must be validated for each customer application by customer's technical experts. **onsemi** does not convey any license under any of its intellectual property rights nor the rights of others. **onsemi** products are not designed, intended, or authorized for use as a critical component in life support systems or any FDA Class 3 medical devices or medical devices with a same or similar classification in a foreign jurisdiction or any devices intended for implantation in the human body. Should Buyer purchase or use **onsemi** products for any such unintended or unauthorized application, Buyer shall indemnify and hold **onsemi** and its officers, employees, subsidiaries, affiliates, and distributors harmless against all claims, costs, damages, and expenses, and reasonable attorney fees arising out of, directly or indirectly, any claim of personal injury or death associated with such unintended or unauthorized use, even if such claim alleges that **onsemi** was negligent regarding the design or manufacture of the part. **onsemi** is an Equal Opportunity/Affirmative Action Employer. This literature is subject to all applicable copyright laws and is not for resale in any manner.

## PUBLICATION ORDERING INFORMATION

### LITERATURE FULFILLMENT:

Email Requests to: [orderlit@onsemi.com](mailto:orderlit@onsemi.com)

**onsemi Website:** [www.onsemi.com](http://www.onsemi.com)

### TECHNICAL SUPPORT

**North American Technical Support:**  
Voice Mail: 1 800-282-9855 Toll Free USA/Canada  
Phone: 011 421 33 790 2910

**Europe, Middle East and Africa Technical Support:**

Phone: 00421 33 790 2910

For additional information, please contact your local Sales Representative