

NSR20F20

Schottky Barrier Diode

These Schottky barrier diodes are optimized for low forward voltage drop and low leakage current and are offered in a Chip Scale Package (CSP) to reduce board space. The low thermal resistance enables designers to meet the challenging task of achieving higher efficiency and meeting reduced space requirements.

Features

- Low Forward Voltage Drop – 450 mV @ 2.0 A
- Low Reverse Current – 30 μ A @ 10 V VR
- 2.0 A of Continuous Forward Current
- Power Dissipation of 665 mW with Minimum Trace
- ESD Rating – Human Body Model: Class 3B
– Machine Model: Class C
- High Switching Speed
- These Devices are Pb-Free, Halogen Free/BFR Free and are RoHS Compliant

Typical Applications

- LCD and Keypad Backlighting
- Camera Photo Flash
- Buck and Boost dc-dc Converters
- Reverse Voltage and Current Protection
- Clamping & Protection

Markets

- Mobile Handsets
- MP3 Players
- Digital Camera and Camcorders
- Notebook PCs & PDAs
- GPS

MAXIMUM RATINGS

Rating	Symbol	Value	Unit
Reverse Voltage	V_R	20	V
Forward Current (DC)	I_F	2.0	A
Forward Surge Current (60 Hz @ 1 cycle)	I_{FSM}	28	A
Repetitive Peak Forward Current (Pulse Wave = 1 sec, Duty Cycle = 66%)	I_{FRM}	4.0	A
ESD Rating: Human Body Model Machine Model	ESD	> 8 > 400	kV V

Stresses exceeding those listed in the Maximum Ratings table may damage the device. If any of these limits are exceeded, device functionality should not be assumed, damage may occur and reliability may be affected.



ON Semiconductor®

www.onsemi.com

20 V SCHOTTKY BARRIER DIODE

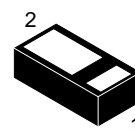

DSN2
(0603)
CASE 152AB

MARKING DIAGRAM

PIN 1

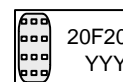

20F20 = Specific Device Code
YYY = Year Code

ORDERING INFORMATION

Device	Package	Shipping†
NSR20F20NXT5G	DSN2 (Pb-Free)	5000 / Tape & Reel

†For information on tape and reel specifications, including part orientation and tape sizes, please refer to our Tape and Reel Packaging Specifications Brochure, BRD8011/D.

NSR20F20

THERMAL CHARACTERISTICS

Characteristic	Symbol	Min	Typ	Max	Unit
Thermal Resistance Junction-to-Ambient (Note 1) Total Power Dissipation @ $T_A = 25^\circ\text{C}$	$R_{\theta JA}$ P_D			213 586	$^\circ\text{C/W}$ mW
Thermal Resistance Junction-to-Ambient (Note 2) Total Power Dissipation @ $T_A = 25^\circ\text{C}$	$R_{\theta JA}$ P_D			80 1.56	$^\circ\text{C/W}$ W
Storage Temperature Range	T_{stg}			-40 to +125	$^\circ\text{C}$
Junction Temperature	T_J			+150	$^\circ\text{C}$

1. Mounted onto a 4 in square FR-4 board 50 mm sq. 1 oz. Cu 0.06" thick single sided. Operating to steady state.
2. Mounted onto a 4 in square FR-4 board 1 in sq. 1 oz. Cu 0.06" thick single sided. Operating to steady state.

ELECTRICAL CHARACTERISTICS ($T_A = 25^\circ\text{C}$ unless otherwise noted)

Characteristic	Symbol	Min	Typ	Max	Unit
Reverse Leakage ($V_R = 10\text{ V}$) ($V_R = 20\text{ V}$)	I_R			30 150	μA
Forward Voltage ($I_F = 1.0\text{ A}$) ($I_F = 2.0\text{ A}$)	V_F		0.390 0.450	0.420 0.470	V
Reverse Recovery Time ($I_F = I_R = 10\text{ mA}$, $I_{R(REC)} = 1.0\text{ mA}$, Figure 4)	t_{rr}		80		ns

NSR20F20

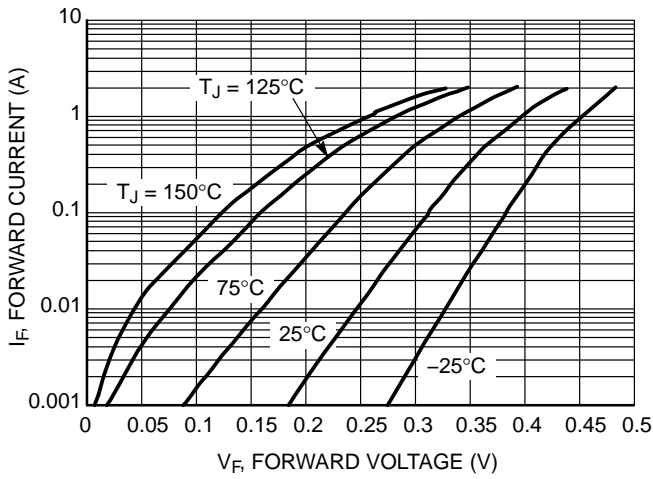

Figure 1. Forward Voltage

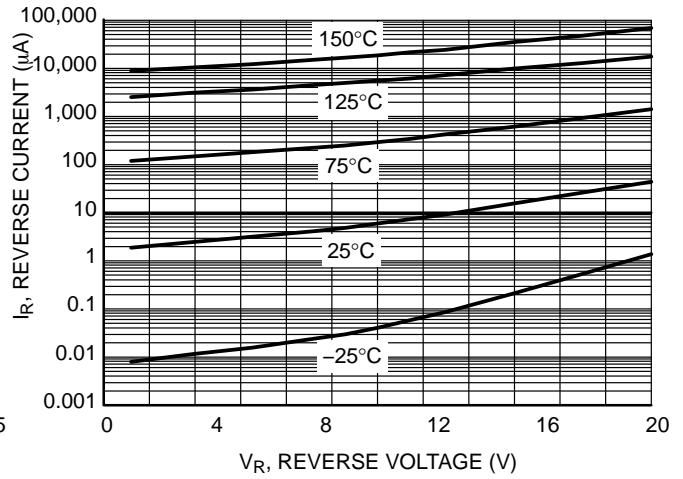

Figure 2. Typical Reverse Current

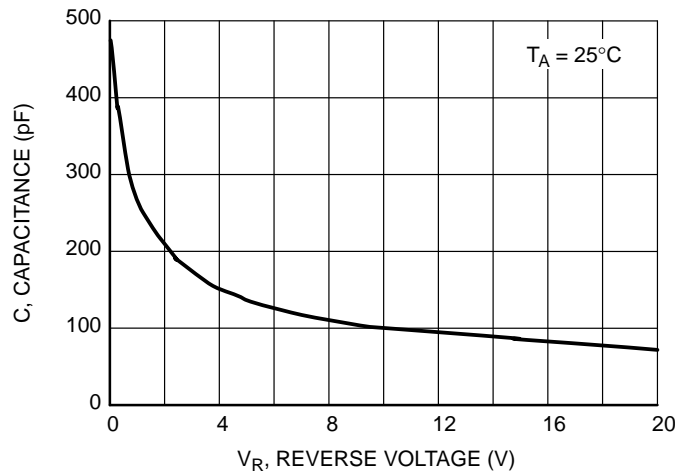
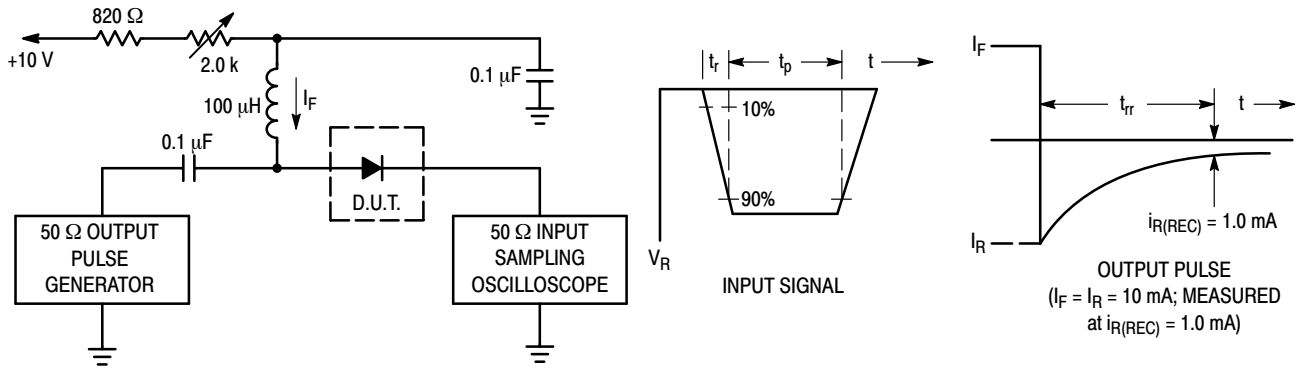

Figure 3. Typical Capacitance



- Notes: 1. A 2.0 kΩ variable resistor adjusted for a Forward Current (I_F) of 10 mA.
- 2. Input pulse is adjusted so $I_{R(peak)}$ is equal to 10 mA.
- 3. $t_p \gg t_{rr}$

Figure 4. Recovery Time Equivalent Test Circuit

MECHANICAL CASE OUTLINE

PACKAGE DIMENSIONS

ON Semiconductor®



SCALE 8:1

DSN2, 1.6x0.8, 0.9P, (0603)
CASE 152AB
ISSUE C

DATE 30 APR 2017

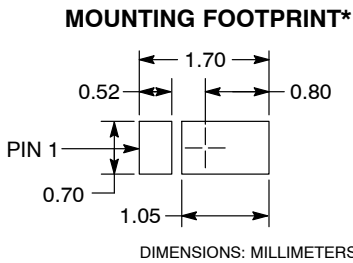
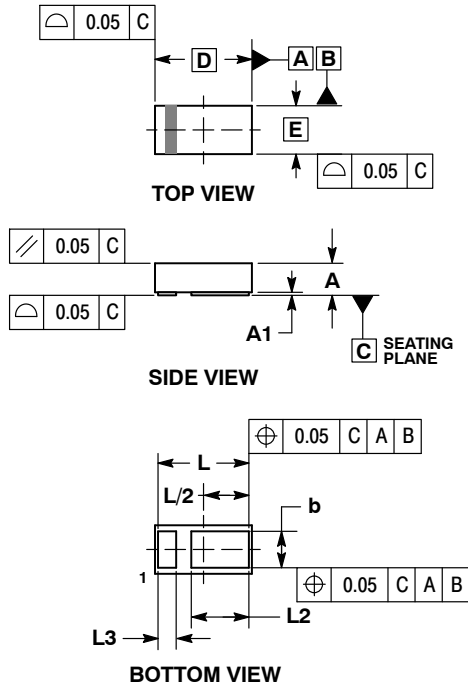

See Application Note AND8464/D for more mounting details

*For additional information on our Pb-Free strategy and soldering details, please download the ON Semiconductor Soldering and Mounting Techniques Reference Manual, SOLDERRM/D.

NOTES:

1. DIMENSIONING AND TOLERANCING PER ASME Y14.5M, 1994.
2. CONTROLLING DIMENSION: MILLIMETERS.

MILLIMETERS		
DIM	MIN	MAX
A	0.25	0.31
A1	---	0.05
b	0.55	0.65
D	1.60 BSC	
E	0.80 BSC	
L	1.45	1.55
L2	0.90	1.00
L3	0.25	0.35

GENERIC MARKING DIAGRAM1*
PIN 1

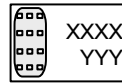

XXXX = Specific Device Code
YYY = Year Code

GENERIC MARKING DIAGRAM2*
PIN 1



XX = Specific Device Code
M = Date Code

*This information is generic. Please refer to device data sheet for actual part marking. Pb-Free indicator, "G", may or not be present. Some products may not follow the Generic Marking.

CATHODE BAND MONTH CODING

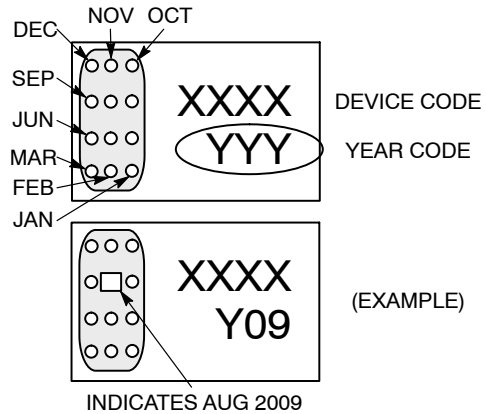

DOCUMENT NUMBER:	98AON40452E	Electronic versions are uncontrolled except when accessed directly from the Document Repository. Printed versions are uncontrolled except when stamped "CONTROLLED COPY" in red.
DESCRIPTION:	DSN2, 1.6X0.8, 0.9P, (0603)	PAGE 1 OF 1

ON Semiconductor and ON are trademarks of Semiconductor Components Industries, LLC dba ON Semiconductor or its subsidiaries in the United States and/or other countries. ON Semiconductor reserves the right to make changes without further notice to any products herein. ON Semiconductor makes no warranty, representation or guarantee regarding the suitability of its products for any particular purpose, nor does ON Semiconductor assume any liability arising out of the application or use of any product or circuit, and specifically disclaims any and all liability, including without limitation special, consequential or incidental damages. ON Semiconductor does not convey any license under its patent rights nor the rights of others.

ON Semiconductor and  are trademarks of Semiconductor Components Industries, LLC dba ON Semiconductor or its subsidiaries in the United States and/or other countries. ON Semiconductor owns the rights to a number of patents, trademarks, copyrights, trade secrets, and other intellectual property. A listing of ON Semiconductor's product/patent coverage may be accessed at www.onsemi.com/site/pdf/Patent-Marking.pdf. ON Semiconductor reserves the right to make changes without further notice to any products herein. ON Semiconductor makes no warranty, representation or guarantee regarding the suitability of its products for any particular purpose, nor does ON Semiconductor assume any liability arising out of the application or use of any product or circuit, and specifically disclaims any and all liability, including without limitation special, consequential or incidental damages. Buyer is responsible for its products and applications using ON Semiconductor products, including compliance with all laws, regulations and safety requirements or standards, regardless of any support or applications information provided by ON Semiconductor. "Typical" parameters which may be provided in ON Semiconductor data sheets and/or specifications can and do vary in different applications and actual performance may vary over time. All operating parameters, including "Typicals" must be validated for each customer application by customer's technical experts. ON Semiconductor does not convey any license under its patent rights nor the rights of others. ON Semiconductor products are not designed, intended, or authorized for use as a critical component in life support systems or any FDA Class 3 medical devices or medical devices with a same or similar classification in a foreign jurisdiction or any devices intended for implantation in the human body. Should Buyer purchase or use ON Semiconductor products for any such unintended or unauthorized application, Buyer shall indemnify and hold ON Semiconductor and its officers, employees, subsidiaries, affiliates, and distributors harmless against all claims, costs, damages, and expenses, and reasonable attorney fees arising out of, directly or indirectly, any claim of personal injury or death associated with such unintended or unauthorized use, even if such claim alleges that ON Semiconductor was negligent regarding the design or manufacture of the part. ON Semiconductor is an Equal Opportunity/Affirmative Action Employer. This literature is subject to all applicable copyright laws and is not for resale in any manner.

PUBLICATION ORDERING INFORMATION

LITERATURE FULFILLMENT:

Email Requests to: orderlit@onsemi.com

ON Semiconductor Website: www.onsemi.com

TECHNICAL SUPPORT

North American Technical Support:
Voice Mail: 1 800-282-9855 Toll Free USA/Canada
Phone: 011 421 33 790 2910

Europe, Middle East and Africa Technical Support:

Phone: 00421 33 790 2910

For additional information, please contact your local Sales Representative