

Automotive 750 V, 950 A Single Side Direct Cooling 6-Pack Power Module

VE-Tract™ Direct Module

NVH950S75L4SPB

Product Description

The NVH950S75L4SPB is a power module from the VE-Trac™ Direct family of highly integrated power modules with industry standard footprints for Hybrid (HEV) and Electric Vehicle (EV) traction inverter application.

The module integrates six Field Stop 4 (FS4) 750 V Narrow Mesa IGBTs in a 6-pack configuration, which excels in providing high current density, while offering robust short circuit protection and increased blocking voltage. Additionally, FS4 750 V Narrow Mesa IGBTs show low power losses during lighter loads, which helps to improve overall system efficiency in automotive applications.

For assembly ease and reliability, a new generation of press-fit pins are integrated into the power module signal terminals. In addition, the power module has an optimized pin-fin heatsink in the baseplate.

Features

- Direct Cooling w/ Integrated Pin-fin Heatsink
- Ultra-low Stray Inductance
- $T_{vjmax} = 175^{\circ}\text{C}$ Continuous Operation
- Low V_{CESAT} and Switching Losses
- Automotive Grade FS4 750 V Narrow Mesa IGBT
- Fast Recovery Diode Chip Technologies
- 4.2 kV Isolated DBC Substrate
- Easy to Integrate 6-pack Topology
- This Device is Pb-Free and is RoHS Compliant

Typical Applications

- Hybrid and Electric Vehicle Traction Inverter
- High Power Converters

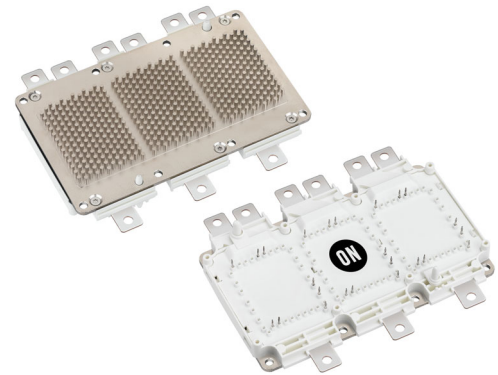

SSDC33, 154.50x92.0 (SPB)
CASE 183AB

MARKING DIAGRAM

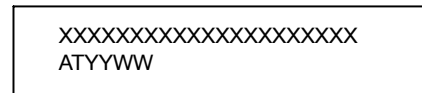

- XXXXXX = Specific Device Code
- AT = Assembly & Test Site Code
- YYWW = Year and Work Week Code

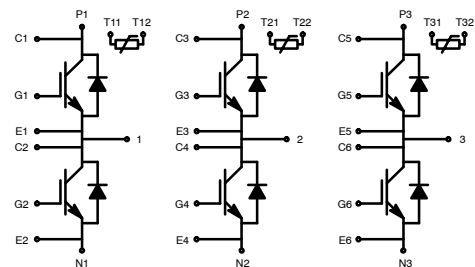

ORDERING INFORMATION

See detailed ordering and shipping information on page 5 of this data sheet.

NVH950S75L4SPB

Pin Description

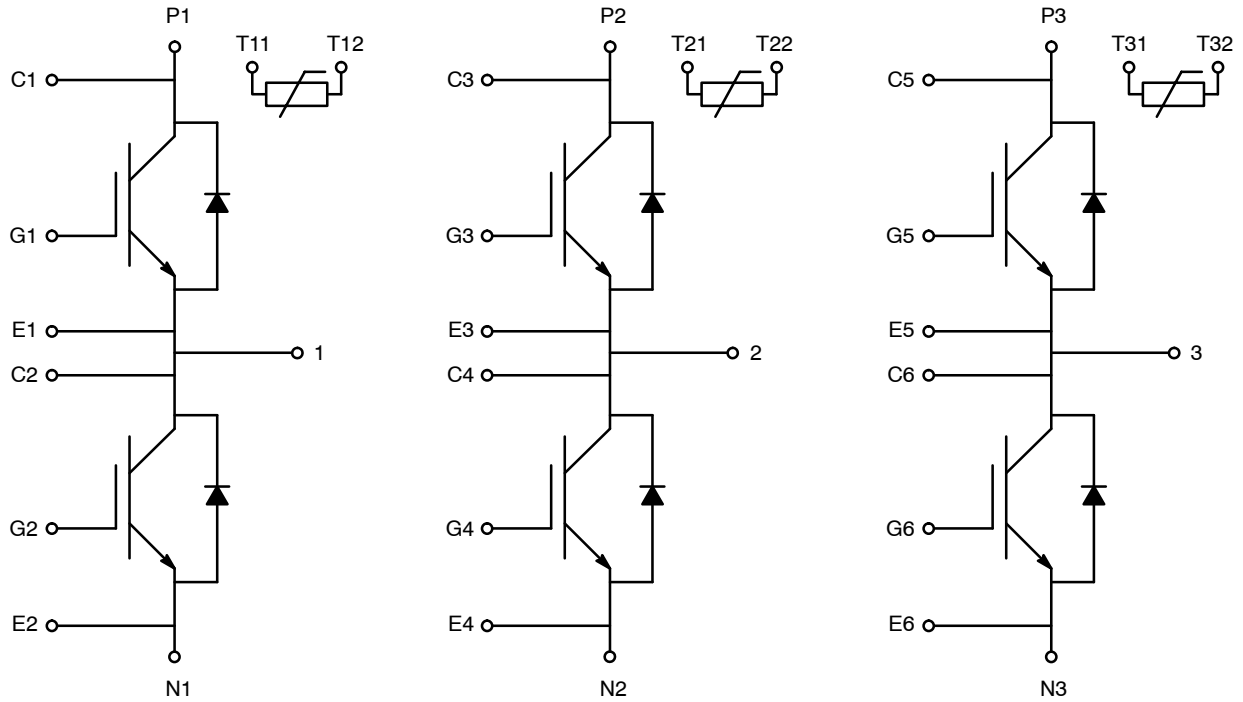

Figure 1. Pin Description

PIN FUNCTION DESCRIPTION

Pin #	Pin Function Description
P1, P2, P3	Positive Power Terminals
N1, N2, N3	Negative Power Terminals
1	Phase 1 Output
2	Phase 2 Output
3	Phase 3 Output
G1-G6	IGBT Gate
E1-E6	IGBT Gate Return
C1-C6	Desat Detect/Collector Sense
T11, T12	Phase 1 Temperature Sensor Output
T21, T22	Phase 2 Temperature Sensor Output
T31, T32	Phase 3 Temperature Sensor Output

Materials

DBC Substrate: SiN isolated substrate, basic isolation,
and copper on both sides

Terminals: Copper + Tin electro-plating

Signal Leads: Copper + Tin plating

Pin-fin Base plate: Copper + Ni plating

Flammability Information

The module frame meets UL94V-0 flammability rating.

NVH950S75L4SPB

MODULE CHARACTERISTICS (T_{vj} = 25°C, Unless Otherwise Specified)

Symbol	Parameter	Rating	Unit
T _{vj}	Operating Junction Temperature	-40 to 175	°C
T _{STG}	Storage Temperature	-40 to 125	°C
V _{ISO}	Isolation Voltage (DC, 0 Hz, 1 s)	4200	V
L _{sCE}	Stray Inductance	8	nH
RCC'+EE'	Module Lead Resistance, Terminals – Chip	0.75	mΩ
G	Module Weight	700	g
CTI	Comparative Tracking Index	>200	-
d _{creep}	Creepage: Terminal to Heatsink Terminal to Terminal	9.0 9.0	mm
d _{clear}	Clearance: Terminal to Heatsink Terminal to Terminal	4.5 4.5	mm

Symbol	Parameters	Conditions	Min	Typ	Max	Unit
Δp	Pressure Drop in Cooling Circuit	10 L/min, 65°C, 50/50 EGW	-	95	-	mbar
P (Note 1)	Maximum Pressure in Cooling Loop (relative)	T _{Baseplate} < 40°C T _{Baseplate} > 40°C	- -	- -	2.5 2.0	bar

1. EPDM rubber 50 durometer 'O' ring used.

ABSOLUTE MAXIMUM RATINGS (T_{vj} = 25°C, Unless Otherwise Specified)

Symbol	Parameter	Rating	Unit
--------	-----------	--------	------

IGBT

V _{CES}	Collector to Emitter Voltage	750	V
V _{GES}	Gate to Emitter Voltage	±20	V
I _{CN}	Implemented Collector Current	950	A
I _{C nom}	Continuous DC Collector Current, T _{vj} = 175°C, T _F = 65°C, Ref. Heatsink	750 (Note 2)	A
I _{CRM}	Pulsed Collector Current @ V _{GE} = 15 V, t _p = 1 ms	1900	A
P _{tot}	Total Power Dissipation T _{vj} = 175°C, T _F = 65°C, Ref. Heatsink	1300	W

Diode

V _{RRM}	Repetitive Peak Reverse Voltage	750	V
I _{FN}	Implemented Forward Current	950	A
I _F	Continuous Forward Current, T _{vj} = 175°C, T _F = 65°C, Ref. Heatsink	500 (Note 2)	A
I _{FRM}	Repetitive Peak Forward Current, t _p = 1 ms	1900	A
I ² t value	Surge Current Capability, t _p = 10 ms, T _{vj} = 150°C T _{vj} = 175°C	19000 16000	A ² s

Stresses exceeding those listed in the Maximum Ratings table may damage the device. If any of these limits are exceeded, device functionality should not be assumed, damage may occur and reliability may be affected.

2. Verified by characterization/design, not by test.

NVH950S75L4SPB

CHARACTERISTICS OF IGBT ($T_{vj} = 25^{\circ}\text{C}$, Unless Otherwise Specified)

Symbol	Parameters	Conditions	Min	Typ	Max	Unit	
V_{CESAT}	Collector to Emitter Saturation Voltage (Terminal)	$V_{GE} = 15\text{ V}$, $I_C = 600\text{ A}$	$T_{vj} = 25^{\circ}\text{C}$	-	1.30	1.55	V
	Collector to Emitter Saturation Voltage (Chip)	$V_{GE} = 15\text{ V}$, $I_C = 600\text{ A}$	$T_{vj} = 25^{\circ}\text{C}$	-	1.25	1.50	
			$T_{vj} = 150^{\circ}\text{C}$	-	1.37	-	
		$V_{GE} = 15\text{ V}$, $I_C = 950\text{ A}$	$T_{vj} = 25^{\circ}\text{C}$	-	1.47	-	
			$T_{vj} = 150^{\circ}\text{C}$	-	1.71	-	
			$T_{vj} = 175^{\circ}\text{C}$	-	1.77	-	
I_{CES}	Collector to Emitter Leakage Current	$V_{GE} = 0$, $V_{CE} = 750\text{ V}$	$T_{vj} = 25^{\circ}\text{C}$	-	-	500	μA
			$T_{vj} = 150^{\circ}\text{C}$	-	2.0	-	mA
I_{GES}	Gate – Emitter Leakage Current	$V_{CE} = 0$, $V_{GE} = \pm 20\text{ V}$		-	-	± 300	nA
V_{th}	Threshold Voltage	$V_{CE} = V_{GE}$, $I_C = 90\text{ mA}$		4.8	5.7	6.6	V
Q_G	Total Gate Charge	$V_{GE} = -8\text{ to }15\text{ V}$, $V_{CE} = 400\text{ V}$		-	2.3	-	μC
R_{Gint}	Internal Gate Resistance			-	1.7	-	Ω
C_{ies}	Input Capacitance	$V_{CE} = 30\text{ V}$, $V_{GE} = 0\text{ V}$, $f = 100\text{ kHz}$		-	60	-	nF
C_{oes}	Output Capacitance	$V_{CE} = 30\text{ V}$, $V_{GE} = 0\text{ V}$, $f = 100\text{ kHz}$		-	1.90	-	nF
C_{res}	Reverse Transfer Capacitance	$V_{CE} = 30\text{ V}$, $V_{GE} = 0\text{ V}$, $f = 100\text{ kHz}$		-	0.2	-	nF
$T_{d,on}$	Turn On Delay, Inductive Load	$I_C = 600\text{ A}$, $V_{CE} = 400\text{ V}$, $V_{GE} = +15/-8\text{ V}$, $R_{g,on} = 4\ \Omega$	$T_{vj} = 25^{\circ}\text{C}$	-	315	-	ns
			$T_{vj} = 150^{\circ}\text{C}$	-	320	-	
			$T_{vj} = 175^{\circ}\text{C}$	-	322	-	
T_r	Rise Time, Inductive Load	$I_C = 600\text{ A}$, $V_{CE} = 400\text{ V}$, $V_{GE} = +15/-8\text{ V}$, $R_{g,on} = 4\ \Omega$	$T_{vj} = 25^{\circ}\text{C}$	-	108	-	ns
			$T_{vj} = 150^{\circ}\text{C}$	-	127	-	
			$T_{vj} = 175^{\circ}\text{C}$	-	132	-	
$T_{d,off}$	Turn Off Delay, Inductive Load	$I_C = 600\text{ A}$, $V_{CE} = 400\text{ V}$, $V_{GE} = +15/-8\text{ V}$, $R_{g,off} = 12\ \Omega$	$T_{vj} = 25^{\circ}\text{C}$	-	1063	-	ns
			$T_{vj} = 150^{\circ}\text{C}$	-	1196	-	
			$T_{vj} = 175^{\circ}\text{C}$	-	1203	-	
T_f	Fall Time, Inductive Load	$I_C = 600\text{ A}$, $V_{CE} = 400\text{ V}$, $V_{GE} = +15/-8\text{ V}$, $R_{g,off} = 12\ \Omega$	$T_{vj} = 25^{\circ}\text{C}$	-	85	-	ns
			$T_{vj} = 150^{\circ}\text{C}$	-	144	-	
			$T_{vj} = 175^{\circ}\text{C}$	-	151	-	
E_{ON}	Turn On Switching Loss (Including Diode Reverse Recovery Loss)	$I_C = 600\text{ A}$, $V_{CE} = 400\text{ V}$, $V_{GE} = +15/-8\text{ V}$, $L_s = 22\text{ nH}$, $R_{g,on} = 4\ \Omega$	$di/dt = 4.5\text{ A/ns}$, $T_{vj} = 25^{\circ}\text{C}$	-	26	-	mJ
			$di/dt = 3.9\text{ A/ns}$, $T_{vj} = 150^{\circ}\text{C}$	-	36	-	
			$di/dt = 3.6\text{ A/ns}$, $T_{vj} = 175^{\circ}\text{C}$	-	38	-	
E_{OFF}	Turn Off Switching Loss	$I_C = 600\text{ A}$, $V_{CE} = 400\text{ V}$, $V_{GE} = +15/-8\text{ V}$, $L_s = 22\text{ nH}$, $R_{g,off} = 12\ \Omega$	$dv/dt = 2.7\text{ V/ns}$, $T_{vj} = 25^{\circ}\text{C}$	-	33	-	mJ
			$dv/dt = 1.9\text{ V/ns}$, $T_{vj} = 150^{\circ}\text{C}$	-	46	-	
			$dv/dt = 1.9\text{ V/ns}$, $T_{vj} = 175^{\circ}\text{C}$	-	50	-	
E_{SC}	Minimum Short Circuit Energy Withstand	$V_{GE} = 15\text{ V}$, $V_{CC} = 400\text{ V}$	$T_{vj} = 25^{\circ}\text{C}$	9	-	-	J
			$T_{vj} = 175^{\circ}\text{C}$	4.5	-	-	

NVH950S75L4SPB

CHARACTERISTICS OF INVERSE DIODE ($T_{vj} = 25^{\circ}\text{C}$, Unless Otherwise Specified)

Symbol	Parameters	Conditions	Min	Typ	Max	Unit	
V_F	Diode Forward Voltage (Terminal)	$I_F = 600\text{ A}$	$T_{vj} = 25^{\circ}\text{C}$	-	1.70	1.95	V
	Diode Forward Voltage (Chip)	$I_F = 600\text{ A}$	$T_{vj} = 25^{\circ}\text{C}$	-	1.60	1.85	
			$T_{vj} = 150^{\circ}\text{C}$	-	1.55	-	
		$I_F = 950\text{ A}$	$T_{vj} = 25^{\circ}\text{C}$	-	1.73	-	
			$T_{vj} = 150^{\circ}\text{C}$	-	1.75	-	
			$T_{vj} = 175^{\circ}\text{C}$	-	1.74	-	
E_{rr}	Reverse Recovery Energy	$I_F = 600\text{ A}$, $V_R = 400\text{ V}$, $V_{GE} = -8\text{ V}$, $R_{g.on} = 4\ \Omega$	$di/dt = 4.5\text{ A/nS}$, $T_{vj} = 25^{\circ}\text{C}$	-	3	-	mJ
			$di/dt = 3.9\text{ A/nS}$, $T_{vj} = 150^{\circ}\text{C}$	-	9	-	
			$di/dt = 3.6\text{ A/nS}$, $T_{vj} = 175^{\circ}\text{C}$	-	11	-	
Q_{rr}	Recovered Charge	$I_F = 600\text{ A}$, $V_R = 400\text{ V}$, $V_{GE} = -8\text{ V}$, $R_{g.on} = 4\ \Omega$	$di/dt = 4.5\text{ A/nS}$, $T_{vj} = 25^{\circ}\text{C}$	-	9	-	μC
			$di/dt = 3.9\text{ A/nS}$, $T_{vj} = 150^{\circ}\text{C}$	-	32	-	
			$di/dt = 3.6\text{ A/nS}$, $T_{vj} = 175^{\circ}\text{C}$	-	39	-	
I_{rr}	Peak Reverse Recovery Current	$I_F = 600\text{ A}$, $V_R = 400\text{ V}$, $V_{GE} = -8\text{ V}$, $R_{g.on} = 4\ \Omega$	$di/dt = 4.5\text{ A/nS}$, $T_{vj} = 25^{\circ}\text{C}$	-	133	-	A
			$di/dt = 3.9\text{ A/nS}$, $T_{vj} = 150^{\circ}\text{C}$	-	246	-	
			$di/dt = 3.6\text{ A/nS}$, $T_{vj} = 175^{\circ}\text{C}$	-	282	-	

NTC SENSOR CHARACTERISTICS ($T_{vj} = 25^{\circ}\text{C}$, Unless Otherwise Specified)

Symbol	Parameters	Conditions	Min	Typ	Max	Unit
R_{25} (Note 3)	Rated Resistance	$T_C = 25^{\circ}\text{C}$	-	5	-	$\text{k}\Omega$
$\Delta R/R$	Deviation of R100	$T_C = 100^{\circ}\text{C}$, $R_{100} = 493\ \Omega$	5	-	5	%
P_{25}	Power Dissipation	$T_C = 25^{\circ}\text{C}$	-	-	20	mW
$B_{25/50}$	B-Value	$R = R_{25} \exp [B_{25/50} (1/T - 1/298)]$	-	3375	-	K
$B_{25/80}$	B-Value	$R = R_{25} \exp [B_{25/80} (1/T - 1/298)]$	-	3411	-	K
$B_{25/100}$	B-Value	$R = R_{25} \exp [B_{25/100} (1/T - 1/298)]$	-	3433	-	K

THERMAL CHARACTERISTICS

Symbol	Parameter	Min	Typ	Max	Unit
IGBT. $R_{th,J-F}$	R_{th} , Junction to Fluid, 10 L/min, 65°C , 50/50 EGW	-	0.083	0.10	$^{\circ}\text{C/W}$
Diode. $R_{th,J-F}$	R_{th} , Junction to Fluid, 10 L/min, 65°C , 50/50 EGW	-	0.13	0.16	$^{\circ}\text{C/W}$

ORDERING INFORMATION

Part Number	Package	Shipping
NVH950S75L4SPB	SSDC33, 154.50x92.0 (SPB) (Pb-Free)	4 Units / Tray

NVH950S75L4SPB

TYPICAL CHARACTERISTICS

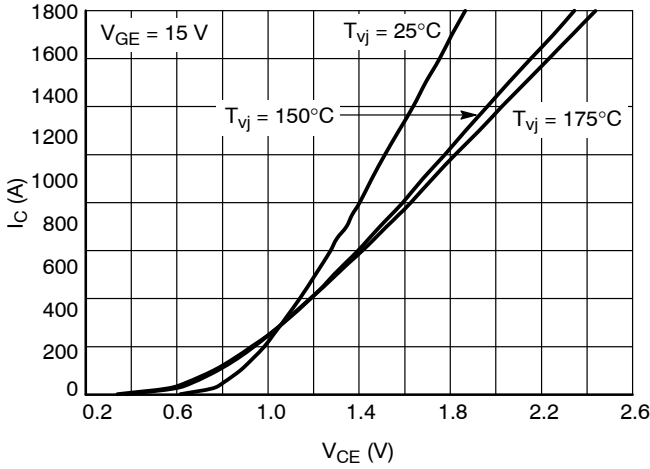

Figure 2. IGBT Output Characteristic

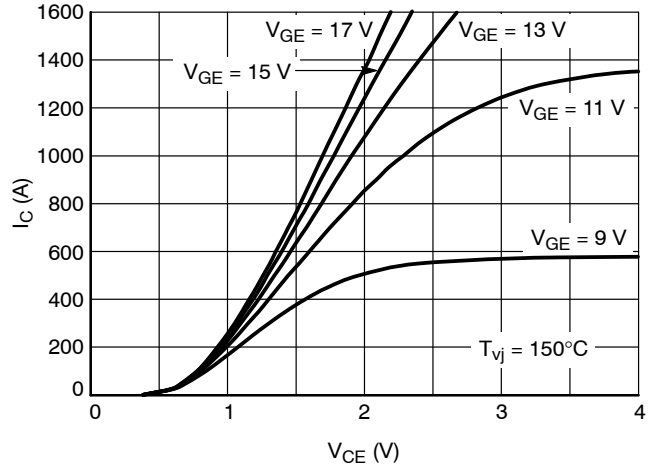

Figure 3. IGBT Output Characteristic

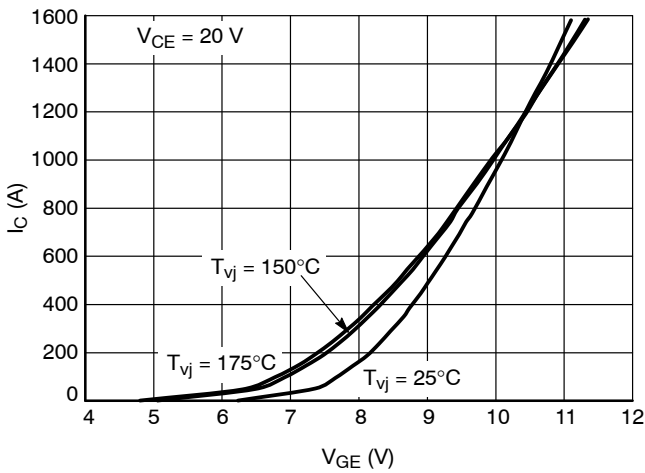

Figure 4. IGBT Transfer Characteristic

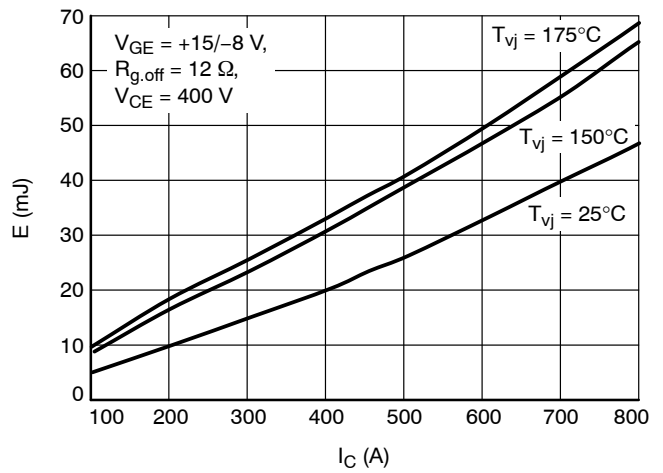

Figure 5. IGBT Turn-off Losses vs. I_C

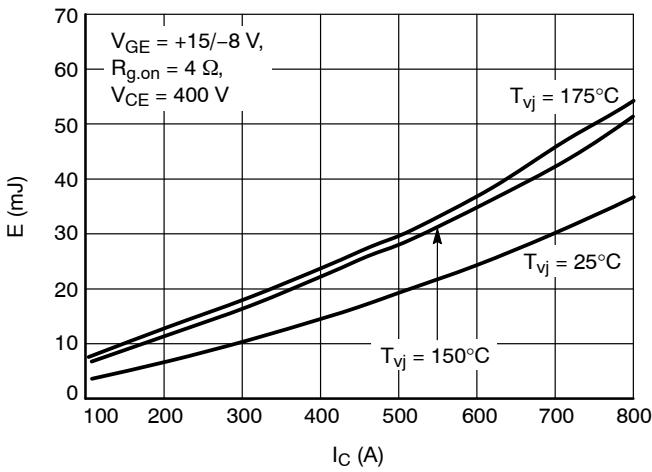

Figure 6. IGBT Turn-on Losses vs. I_C

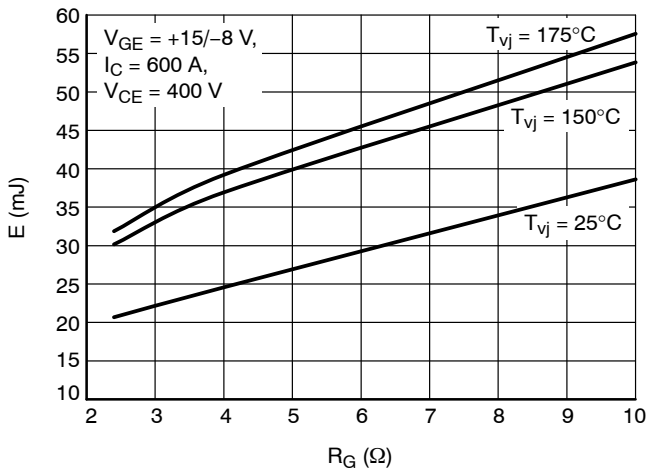

Figure 7. E_{ON} vs. R_G

NVH950S75L4SPB

TYPICAL CHARACTERISTICS

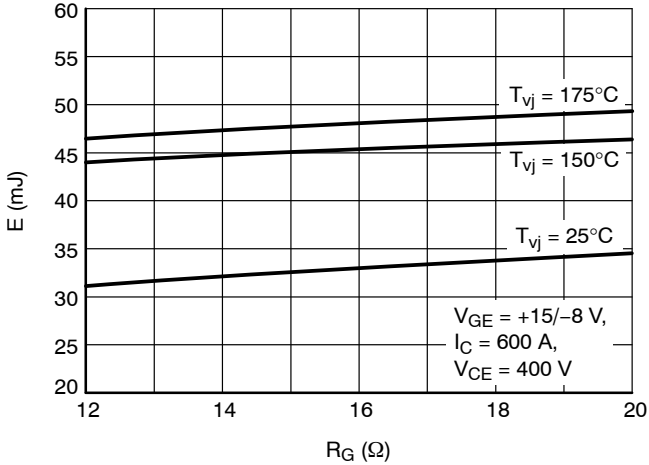

Figure 8. E_{OFF} vs. R_G

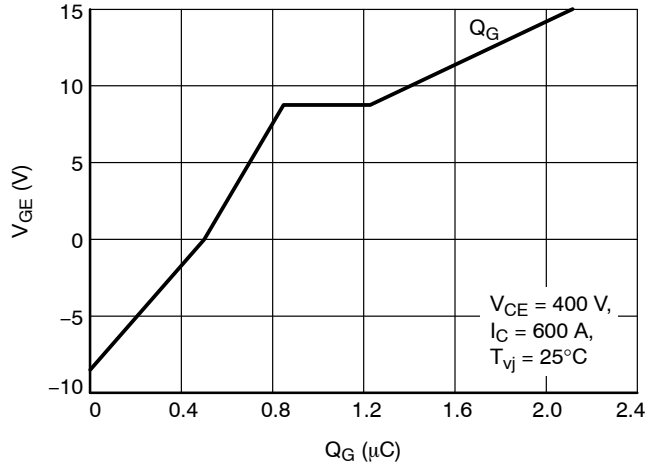

Figure 9. Gate Charge Characteristic

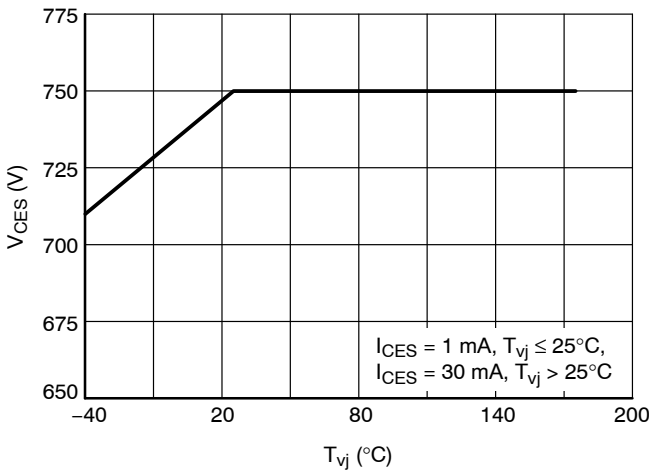

Figure 10. Maximum Allowed V_{CE}

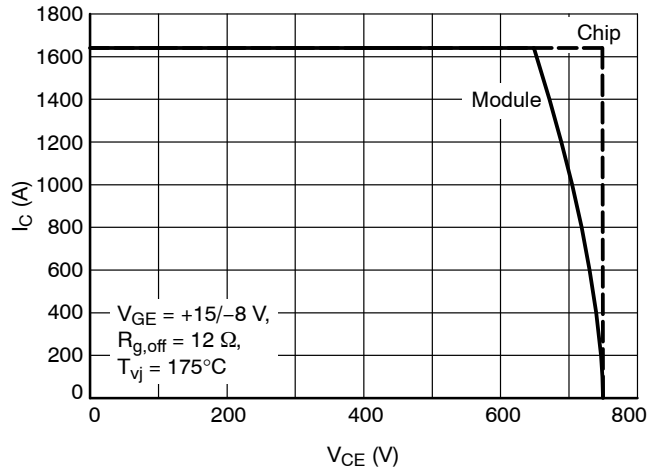

Figure 11. Reverse Bias Safe Operating Area

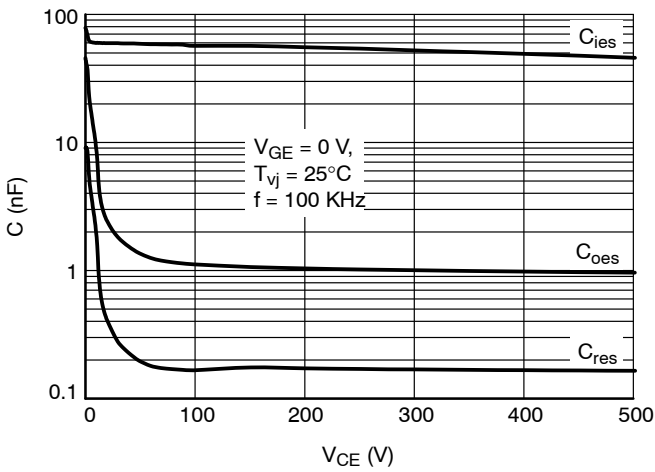

Figure 12. Capacitance Characteristic

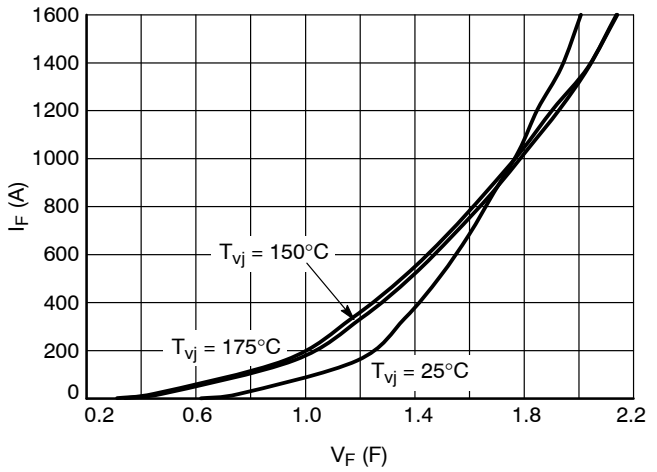

Figure 13. Diode Forward Characteristic

TYPICAL CHARACTERISTICS

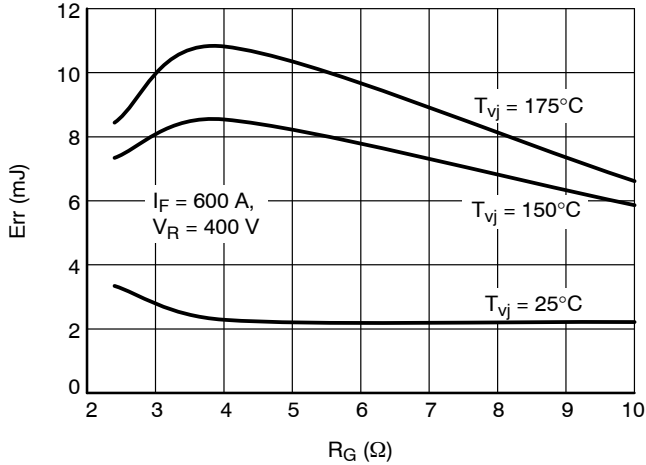

Figure 14. Diode Switching Losses vs. R_G

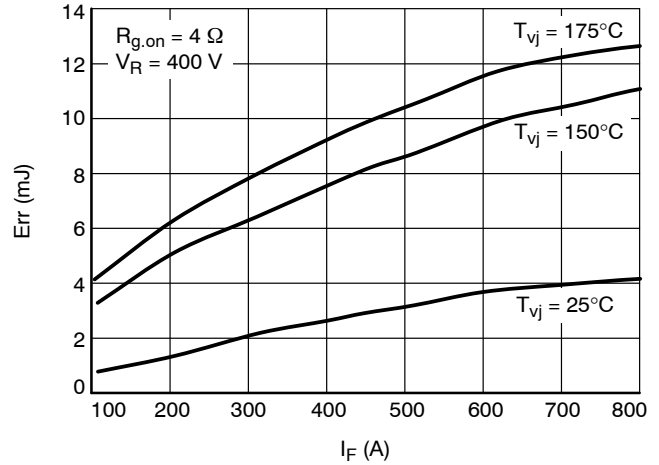

Figure 15. Diode Switching Losses vs. I_F

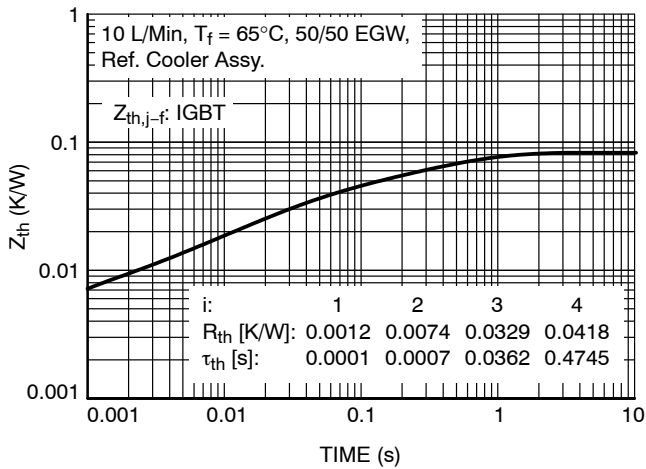

Figure 16. IGBT Transient Thermal Impedance (Typ.)

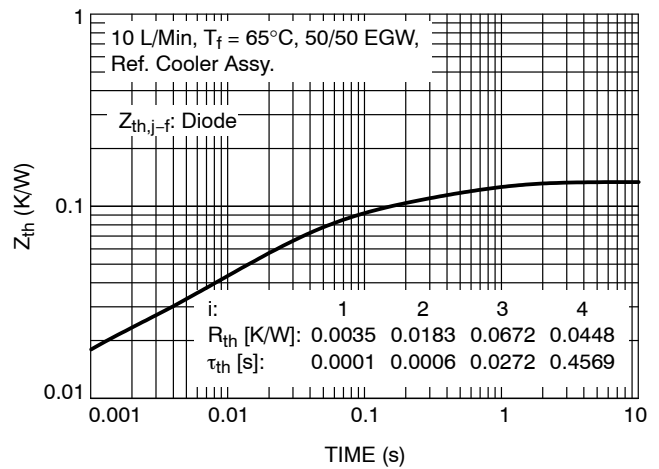

Figure 17. Diode Transient Thermal Impedance (Typ.)

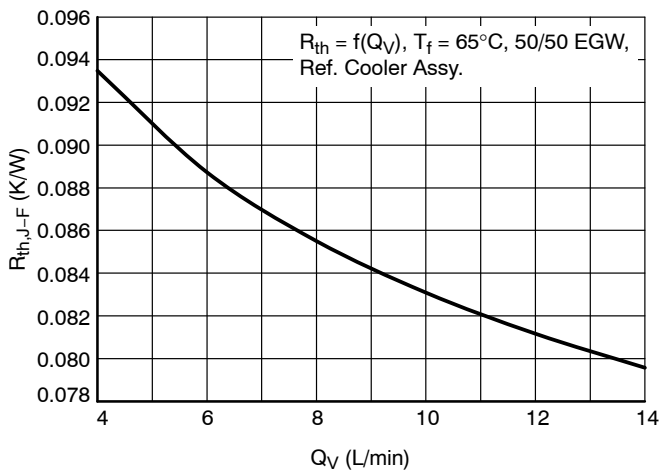

Figure 18. IGBT, Thermal Resistance (Typ.)

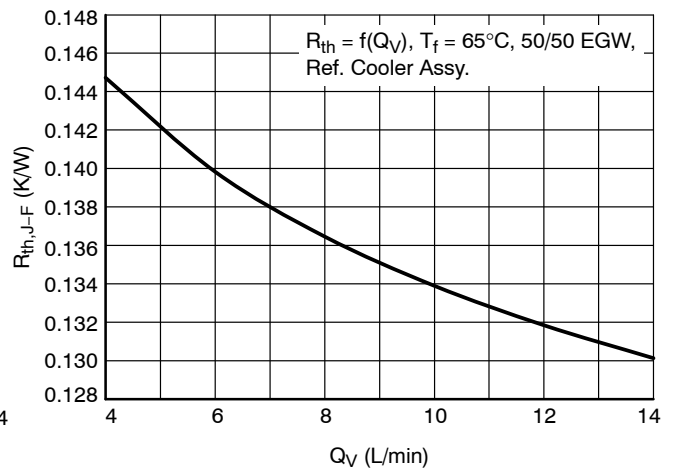

Figure 19. Diode, Thermal Resistance (Typ.)

NVH950S75L4SPB

TYPICAL CHARACTERISTICS

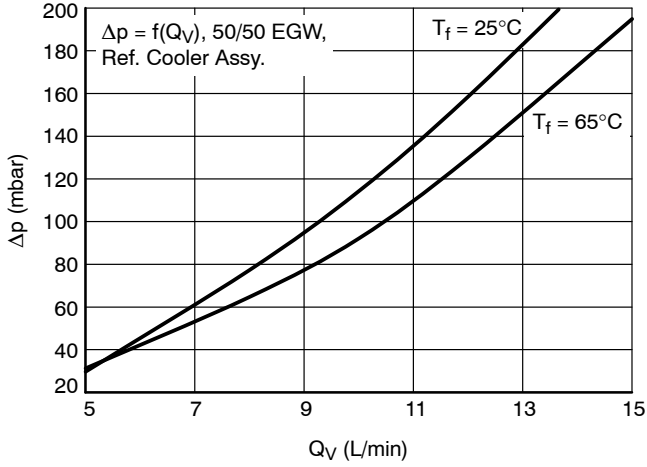

Figure 20. Pressure Drop in Cooling Circuit

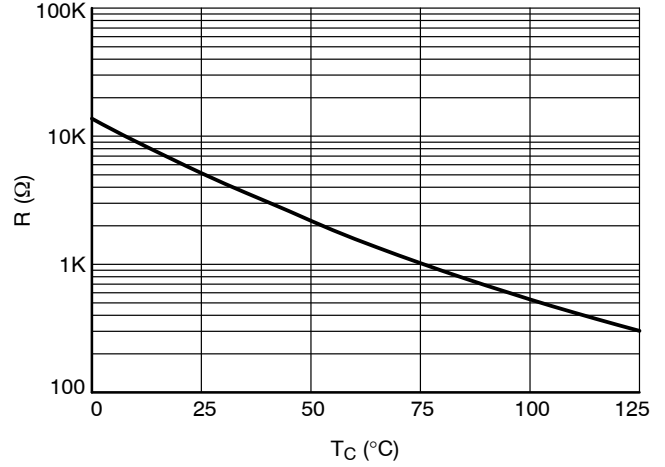
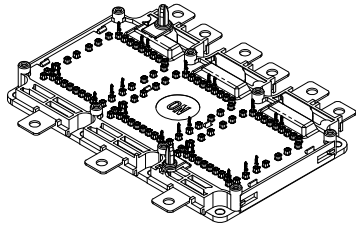

Figure 21. NTC Thermistor - Temperature Characteristic (Typ.)

MECHANICAL CASE OUTLINE

PACKAGE DIMENSIONS

ON Semiconductor®



SSDC33, 154.50x92.0 (SPB)
CASE 183AB
ISSUE A

DATE 05 DEC 2019

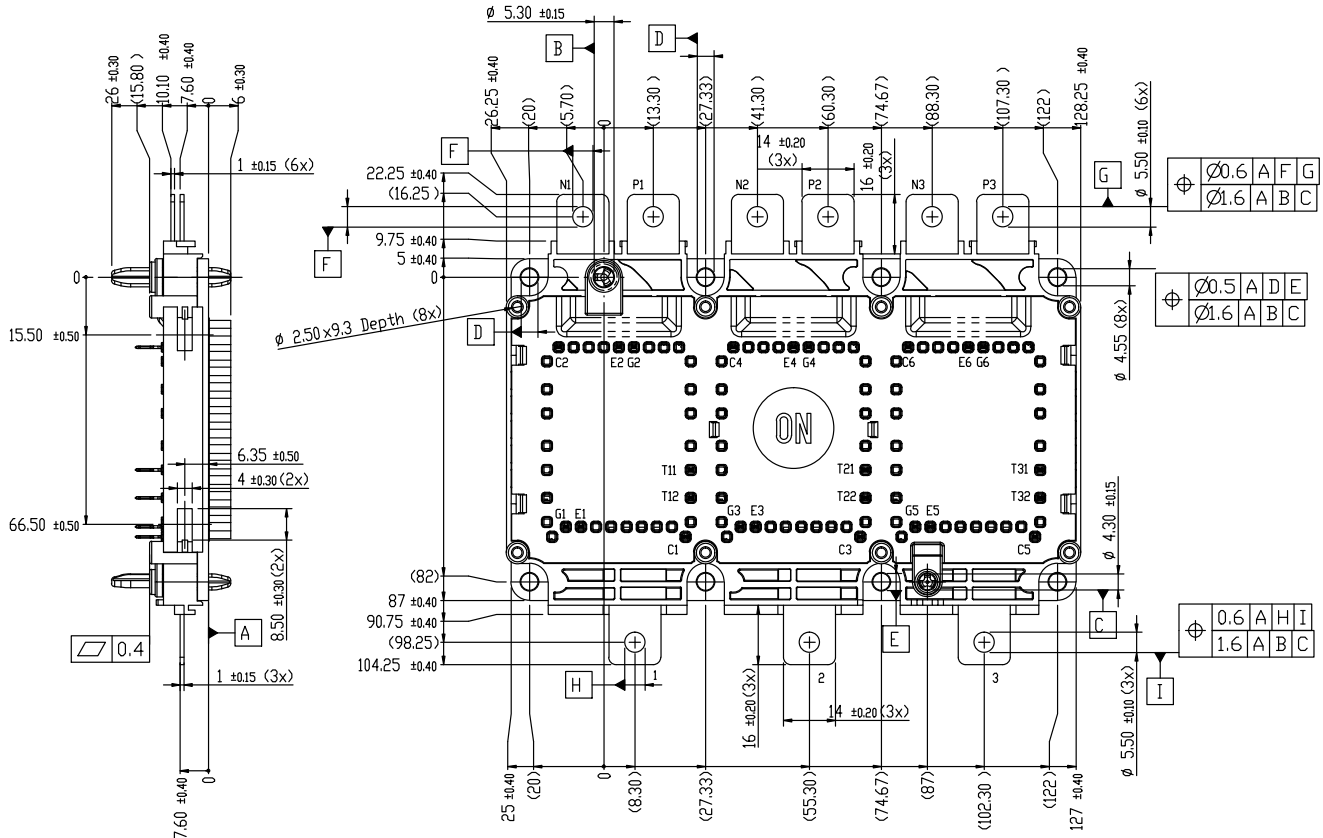

GENERIC MARKING DIAGRAM*

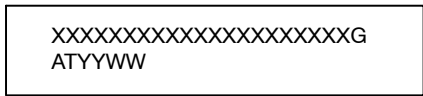

XXXXX = Specific Device Code
 G = Pb-Free Package
 AT = Assembly & Test Site Code
 YYWW = Year and Work Week Code

*This information is generic. Please refer to device data sheet for actual part marking. Pb-Free indicator, "G" or microdot "•", may or may not be present. Some products may not follow the Generic Marking.

DOCUMENT NUMBER:	98AON10436H	Electronic versions are uncontrolled except when accessed directly from the Document Repository. Printed versions are uncontrolled except when stamped "CONTROLLED COPY" in red.
DESCRIPTION:	SSDC33, 154.50x92.0 (SPB)	PAGE 1 OF 2

ON Semiconductor and are trademarks of Semiconductor Components Industries, LLC dba ON Semiconductor or its subsidiaries in the United States and/or other countries. ON Semiconductor reserves the right to make changes without further notice to any products herein. ON Semiconductor makes no warranty, representation or guarantee regarding the suitability of its products for any particular purpose, nor does ON Semiconductor assume any liability arising out of the application or use of any product or circuit, and specifically disclaims any and all liability, including without limitation special, consequential or incidental damages. ON Semiconductor does not convey any license under its patent rights nor the rights of others.

MECHANICAL CASE OUTLINE

PACKAGE DIMENSIONS

ON Semiconductor®



SSDC33, 154.50x92.0 (SPB) CASE 183AB ISSUE A

DATE 05 DEC 2019

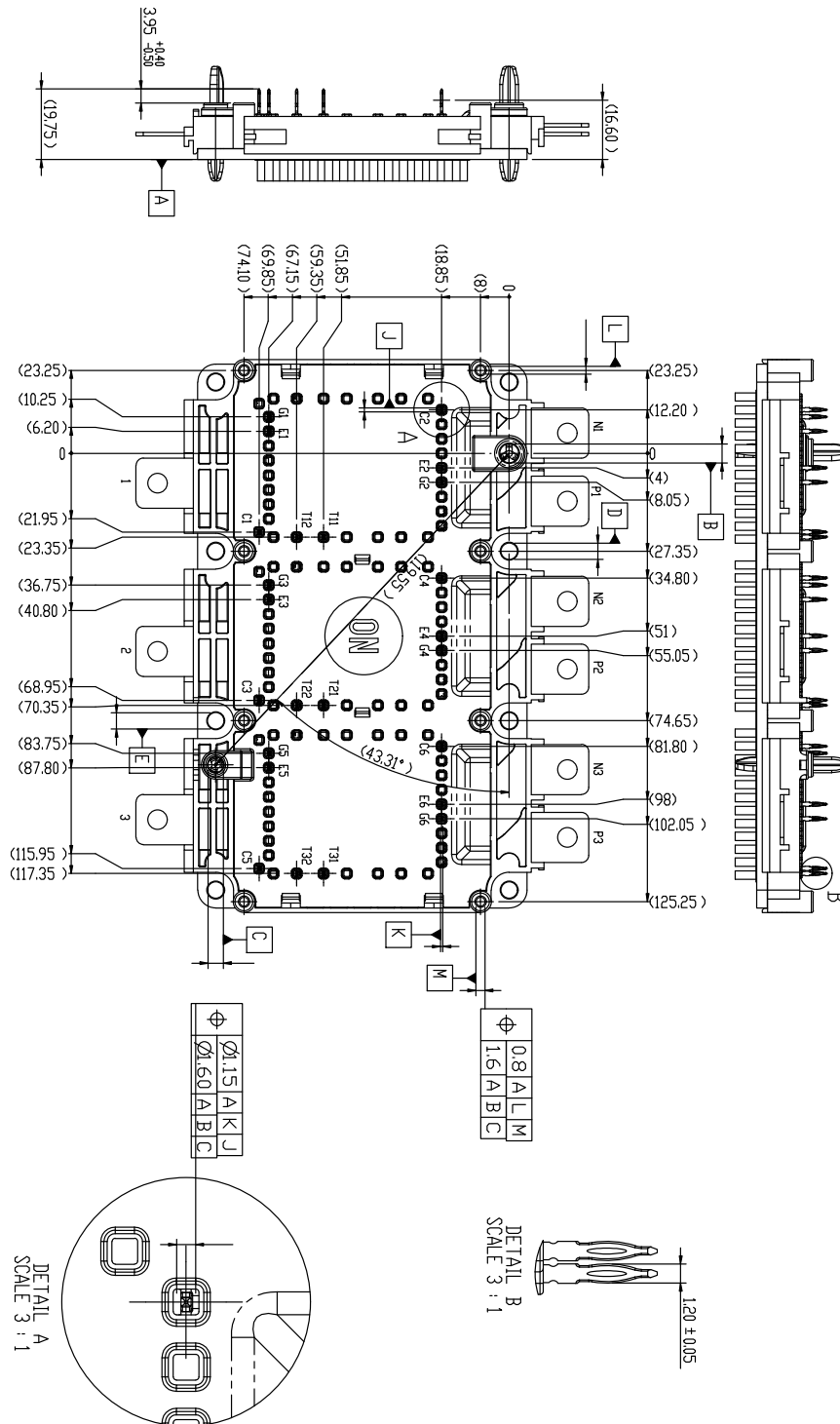

DOCUMENT NUMBER:	98AON10436H	Electronic versions are uncontrolled except when accessed directly from the Document Repository. Printed versions are uncontrolled except when stamped "CONTROLLED COPY" in red.
DESCRIPTION:	SSDC33, 154.50x92.0 (SPB)	PAGE 2 OF 2

ON Semiconductor and are trademarks of Semiconductor Components Industries, LLC dba ON Semiconductor or its subsidiaries in the United States and/or other countries. ON Semiconductor reserves the right to make changes without further notice to any products herein. ON Semiconductor makes no warranty, representation or guarantee regarding the suitability of its products for any particular purpose, nor does ON Semiconductor assume any liability arising out of the application or use of any product or circuit, and specifically disclaims any and all liability, including without limitation special, consequential or incidental damages. ON Semiconductor does not convey any license under its patent rights nor the rights of others.

onsemi, **Onsemi**, and other names, marks, and brands are registered and/or common law trademarks of Semiconductor Components Industries, LLC dba "**onsemi**" or its affiliates and/or subsidiaries in the United States and/or other countries. **onsemi** owns the rights to a number of patents, trademarks, copyrights, trade secrets, and other intellectual property. A listing of **onsemi**'s product/patent coverage may be accessed at www.onsemi.com/site/pdf/Patent-Marking.pdf. **onsemi** reserves the right to make changes at any time to any products or information herein, without notice. The information herein is provided "as-is" and **onsemi** makes no warranty, representation or guarantee regarding the accuracy of the information, product features, availability, functionality, or suitability of its products for any particular purpose, nor does **onsemi** assume any liability arising out of the application or use of any product or circuit, and specifically disclaims any and all liability, including without limitation special, consequential or incidental damages. Buyer is responsible for its products and applications using **onsemi** products, including compliance with all laws, regulations and safety requirements or standards, regardless of any support or applications information provided by **onsemi**. "Typical" parameters which may be provided in **onsemi** data sheets and/or specifications can and do vary in different applications and actual performance may vary over time. All operating parameters, including "Typicals" must be validated for each customer application by customer's technical experts. **onsemi** does not convey any license under any of its intellectual property rights nor the rights of others. **onsemi** products are not designed, intended, or authorized for use as a critical component in life support systems or any FDA Class 3 medical devices or medical devices with a same or similar classification in a foreign jurisdiction or any devices intended for implantation in the human body. Should Buyer purchase or use **onsemi** products for any such unintended or unauthorized application, Buyer shall indemnify and hold **onsemi** and its officers, employees, subsidiaries, affiliates, and distributors harmless against all claims, costs, damages, and expenses, and reasonable attorney fees arising out of, directly or indirectly, any claim of personal injury or death associated with such unintended or unauthorized use, even if such claim alleges that **onsemi** was negligent regarding the design or manufacture of the part. **onsemi** is an Equal Opportunity/Affirmative Action Employer. This literature is subject to all applicable copyright laws and is not for resale in any manner.

ADDITIONAL INFORMATION

TECHNICAL PUBLICATIONS:

Technical Library: www.onsemi.com/design/resources/technical-documentation
onsemi Website: www.onsemi.com

ONLINE SUPPORT: www.onsemi.com/support

For additional information, please contact your local Sales Representative at www.onsemi.com/support/sales