

AR0135CS



































CMOS 1.2 MP1/3"

1/3 1.2 MP "" AR0135 10 4

- ON Semiconductor's Next Generation Global Shutter Technology
- Superior Low-light Performance
- HD Video (720p60)
- Video/Single Frame Mode
- Flexible Row-skip Modes
- On-chip AE and Statistics Engine
- Parallel and Serial Output
- Support for External LED or Flash
- Auto Black Level Calibration
- Context Switching

For more features, see the data sheet

- Barcode scanner
- 3D scanning
- Positional tracking
- Iris Scanning
- Augmented Reality

	Pricing (\$/Unit)	Compliance	Status	Type	Megapixels	Frame Rate (fps)	Optical Format	Shutter Type	Pixel Size (µm)	Output Interface	Color	Package Type
AR0135CS2C00 SUEA0-DPBR		 	Active	CMOS	1.2		1/3 inch	Global Shutter	3.75 x 3.75		RGB	IBGA-63
AR0135CS2C00 SUEA0-DPBR1		 	Active	CMOS	1.2		1/3 inch	Global Shutter	3.75 x 3.75		RGB	IBGA-63
AR0135CS2C00 SUEA0-DRBR		 	Active	CMOS	1.2		1/3 inch	Global Shutter	3.75 x 3.75		RGB	IBGA-63
AR0135CS2C00 SUEA0-DRBR1		 	Active	CMOS	1.2		1/3 inch	Global Shutter	3.75 x 3.75		RGB	IBGA-63
AR0135CS2C19 SUEA0-DPBR1		 	Active	CMOS	1.2		1/3 inch	Global Shutter	3.75 x 3.75		RGB	IBGA-63
AR0135CS2C19 SUEA0-DRBR		 	Active	CMOS	1.2		1/3 inch	Global Shutter	3.75 x 3.75		RGB	IBGA-63
AR0135CS2C19 SUEA0-DRBR1		 	Active	CMOS	1.2		1/3 inch	Global Shutter	3.75 x 3.75		RGB	IBGA-63
AR0135CS2M00 SUEA0-DPBR		 	Active	CMOS	1.2		1/3 inch	Global Shutter	3.75 x 3.75		Mono	IBGA-63
AR0135CS2M00 SUEA0-DPBR1		 	Active	CMOS	1.2		1/3 inch	Global Shutter	3.75 x 3.75		Mono	IBGA-63
AR0135CS2M00 SUEA0-DRBR		 	Active	CMOS	1.2		1/3 inch	Global Shutter	3.75 x 3.75		Mono	IBGA-63
AR0135CS2M00 SUEA0-DRBR1		 	Active	CMOS	1.2		1/3 inch	Global Shutter	3.75 x 3.75		Mono	IBGA-63
AR0135CS2M25 SUD20		 	Active	CMOS	1.2		1/3 inch	Global Shutter	3.75 x 3.75		Mono	
AR0135CS2M25 SUEA0-DPBR		 	Active	CMOS	1.2		1/3 inch	Global Shutter	3.75 x 3.75		Mono	IBGA-63
AR0135CS2M25 SUEA0-DPBR1		 	Active	CMOS	1.2		1/3 inch	Global Shutter	3.75 x 3.75		Mono	IBGA-63
AR0135CS2M25 SUEA0-DRBR		 	Active	CMOS	1.2		1/3 inch	Global Shutter	3.75 x 3.75		Mono	IBGA-63
AR0135CS2M25 SUEA0-DRBR1		 	Active	CMOS	1.2		1/3 inch	Global Shutter	3.75 x 3.75		Mono	IBGA-63
AR0135CS2M25 SUEA0-TPBR		 	Active	CMOS	1.2		1/3 inch	Global Shutter	3.75 x 3.75		Mono	IBGA-63

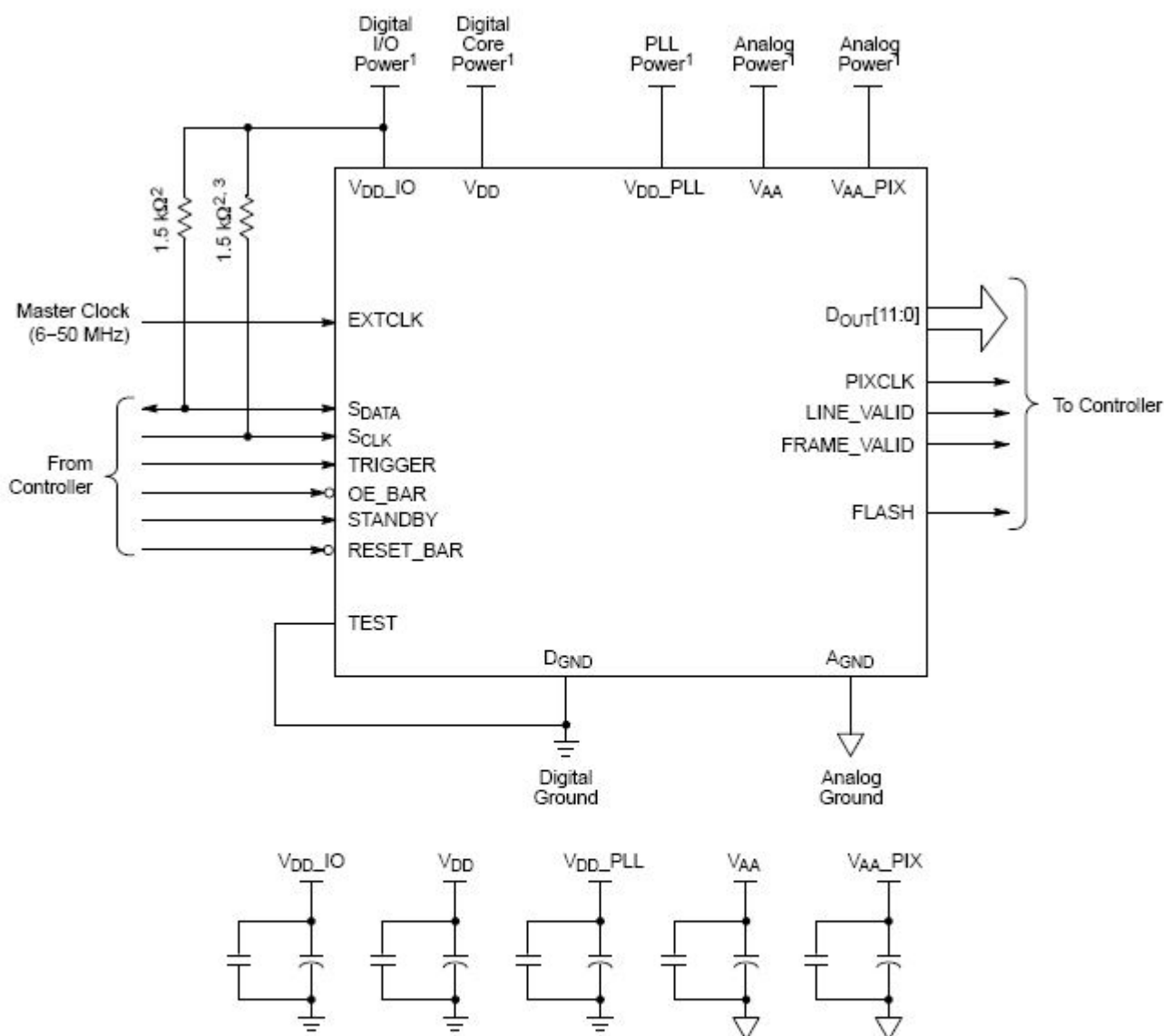

Notes:

1. All power supplies must be adequately decoupled.
2. ON Semiconductor recommends a resistor value of 1.5 kΩ, but a greater value may be used for slower two-wire speed.
3. This pull-up resistor is not required if the controller drives a valid logic level on S_{CLK} at all times.
4. The serial interface output pads can be left unconnected if the parallel output interface is used.
5. ON Semiconductor recommends that 0.1 μF and 10 μF decoupling capacitors for each power supply are mounted as close as possible to the pad. Actual values and results may vary depending on the layout and design considerations. Refer to the AR0135CS demo headboard schematics for circuit recommendations.
6. ON Semiconductor recommends that analog power planes are placed in a manner such that coupling with the digital power planes is minimized.