



Low Power, Ultra-wide AC Input Range, E-meter Power Supply

DESIGN NOTE

Table 1. DEVICE DETAILS

Device	Application	Input Voltage	Output Power	Topology	I/O Isolation
NCP1251	Smart Meters, Electric Meters	70 to 520 Vac	Up to 10 W	DCM Flyback	Isolated

Characteristic	Output Specification
Output Voltage	12 Vdc
Ripple	200 mV p/p @ Full Load
Nominal Current	800 mA
Max Current	1.0 A Maximum
Min Current	Zero

PFC (Yes/No)	No, (Pout < 25 W)
Minimum Efficiency	See Efficiency Plots Below
Inrush Limiting/Fuse	Inrush Resistor (R1)
Operating Temp. Range	0 to +60°C (Dependent on Q1 Heatsinking)
Cooling Method/Supply Orientation	Convection
Signal Level Control	None

Circuit Description

This design note describes a simple, low power (10 W or less), ultra-wide AC input range, constant voltage power supply intended for powering the electronics for electric meters, Smart Grid or similar industrial applications where isolation from the AC mains is required along with a very wide input voltage range.

The power supply is a simple flyback converter topology which operates in discontinuous conduction mode (DCM). The converter utilizes a 1.5 kV rated MOSFET (Q1) to allow for the extremely wide AC input range. The overall efficiency due to the ultra-wide range design is less than that of the universal AC input version (85 – 270 Vac) of a similar NCP1251 circuit presented in ON Semiconductor Design Note [DN05012](#).

This Design Note provides the complete circuit and transformer design details for a 12 V, 1 A power supply. Other output voltages from 3.3 up to 28 Vdc are easy to implement by modifying the values (or ratings) of R12, R16, D8, C10 and T1's secondary turns. The NCP1251B control

circuit provides for over power compensation (R11) as well as over-current and over-voltage protection. An input EMI filter is also provided that meets FCC Level B for conducted EMI. SPICE simulations of the input filter also indicates that it will also provide lightning transient protection with an optional TVS device (TVS1) across the input.

Performance characteristics for efficiency, output ripple, hold-up time, EMI, and switching characteristics are shown in the figures below.

Key Features

- Ultra-wide AC Input Range (70–520 Vac) with 1.5 kV Rated MOSFET (Q1)
- Input Filter (Pi-network) for Conducted EMI Attenuation and Input Transient Protection
- Very Low Standby Power Consumption
- Secondary Circuit Easily Configured for Different Output Voltages
- Inherent Over-current, Over-voltage Protection and Optional Over-power Compensation

CIRCUIT SCHEMATIC

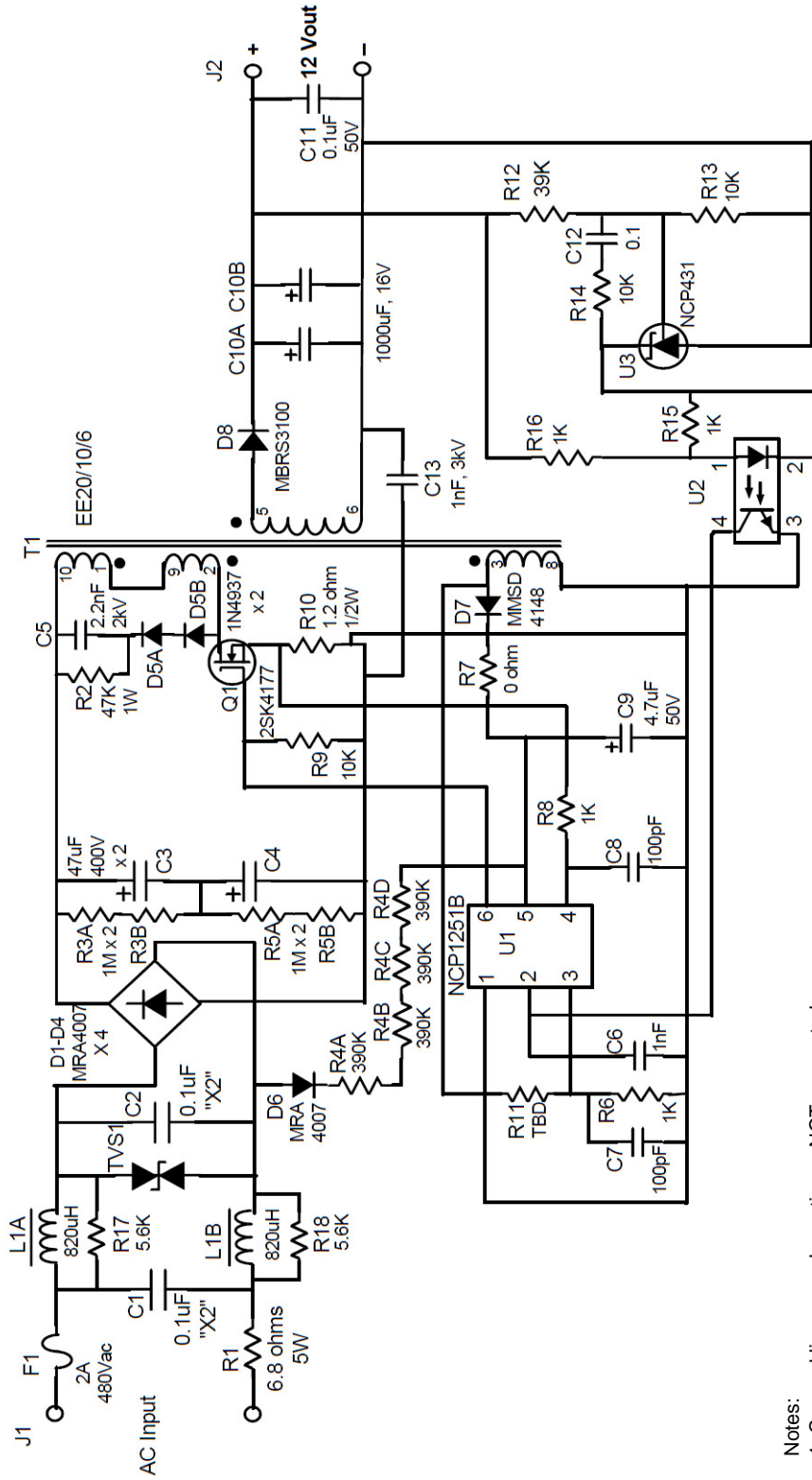

- Notes:
1. Crossed lines on schematic are NOT connected.
 2. U2 is NEC PS2561L-1 or equivalent optocoupler (CTR > 50%)
 3. R1 is for inrush limiting – use wire wound resistor for high joule rating.
 4. L1A/L1B are Coilcraft RFB0810-821L inductors (820 µH, 500 mA).
 5. Output cap (C10) is radial lead, low impedance type (UCC LXV series or similar).
 6. R11 is output power compensation resistor.
 7. TVS1 is optional transient voltage suppressor for lightning protection.
 8. C1 and C2 are 480 Vac rated "X" capacitors for ultra-wide AC input.
 9. See drawing for T1 details.

10 W NCP1251 Power Supply with Ultra Wide AC Input

12 V Transformer Design

Project/Customer: ON Semiconductor – 12 W, 12 Vout NCP1251 Flyback

Part Description: Flyback Transformer, 12 Vout (Würth Electronics part # 750312495)

Schematic ID: T1

Core Type: EE20/10/6 Ferrite Core; 3C90 Material or Similar

Core Gap: Gap for $190 \pm 200 \mu\text{H}$ across Primary A (Pins 1 – 10)

Inductance: $750 \mu\text{H}$ Total ($\pm 5\%$) Measured from Pin 1 to Pin 9 with Pins 2 and 10 Connected

Bobbin Type: 10 Pin Horizontal Mount for EE20/10/6

Windings (in order):

Winding #/Type	Turns/Material/Gauge/Insulation Data
Primary A (1 – 10)	30T of #28HN over 1 layer (25 TPL). Insulate for 1 kV to next winding. Self leads to pins.
Vcc (3 – 8)	7 turns of #28 HN over 1 layer, spiral wound over primary A. Self leads to pins. Insulate to 1 kV to next winding with tape.
12 V Secondary (5 – 6)	6 turns bifilar of #24 triple insulated wire over one. layer (two strands). Self leads to pins. (Note: #26 is also acceptable here if the fit is too tight for one layer)
Primary B (2 – 9)	Same as Primary A. Insulate with tape and self-leads to pins.

Hipot: 3 kV from primaries & Vcc to secondary for 1 minute.

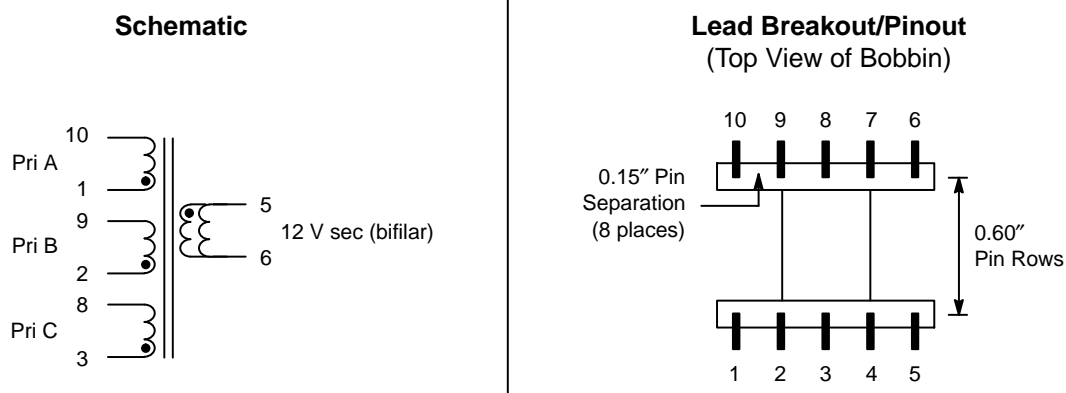

A 5 Vout version of this transformer is available on request.

DN05017/D

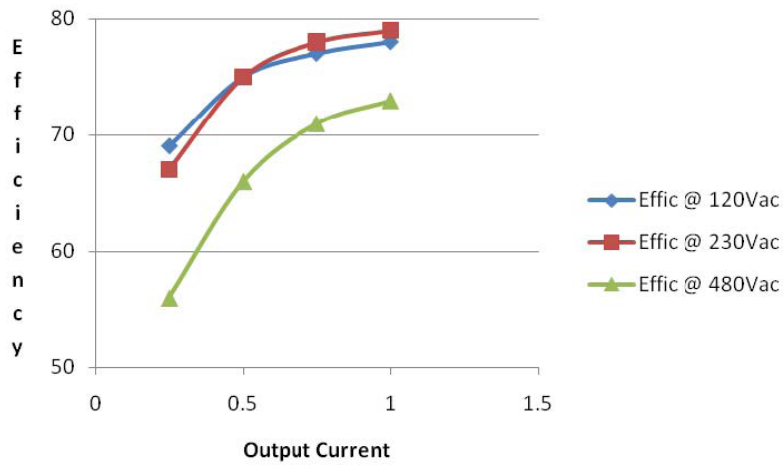

Figure 1. Efficiency Plots

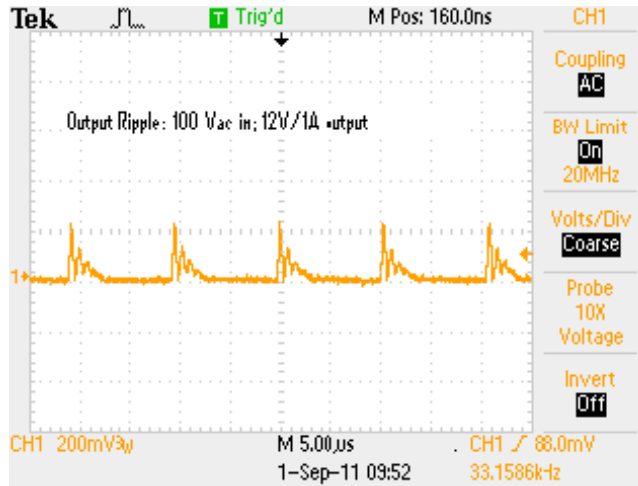

Figure 2. Full Load Output Ripple (100 Vac Input)

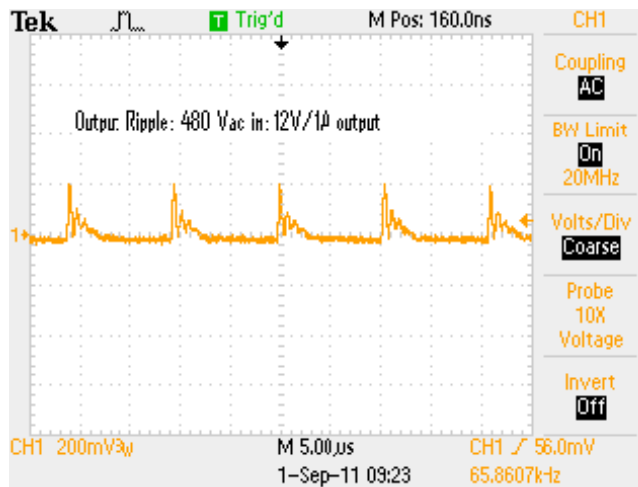

Figure 3. Full Load Output Ripple (480 Vac Input)

DN05017/D

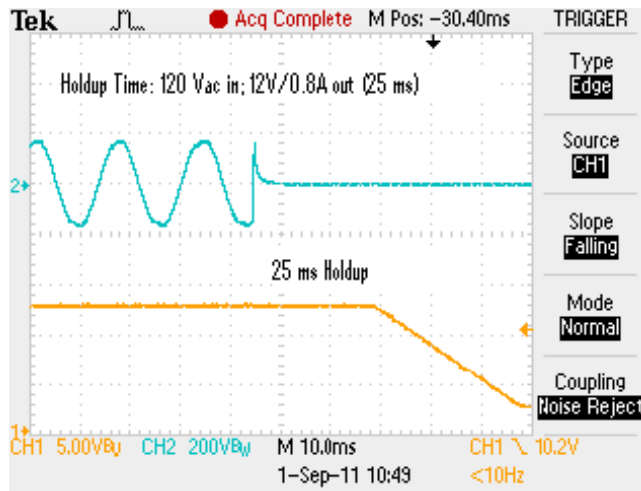

Figure 4. Full Load Hold-up Time at 120 Vac (10 W Output, C3/C4 = 47 μ F)

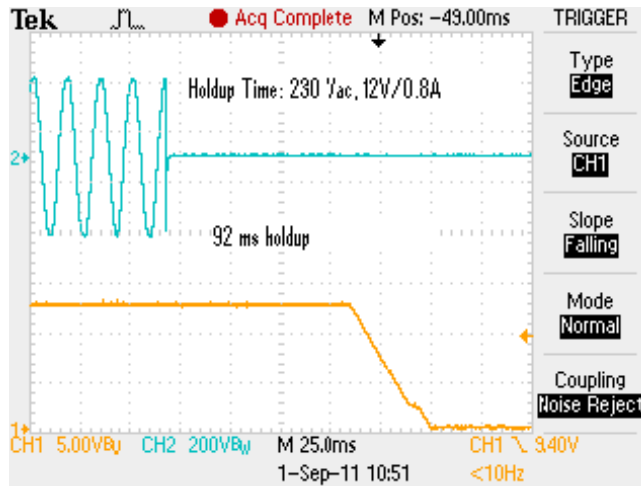

Figure 5. Full Load Hold-up Time at 230 Vac (10 W Output, C3/C4 = 47 μ F)

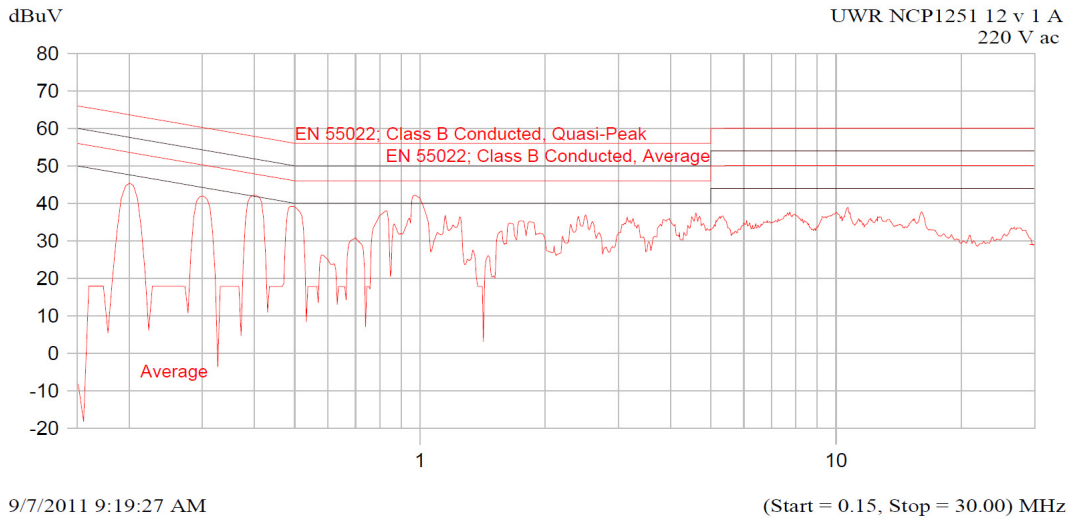

Figure 6. EMI Profile – Class B, Average (220 Vac Input, 10 W Output)

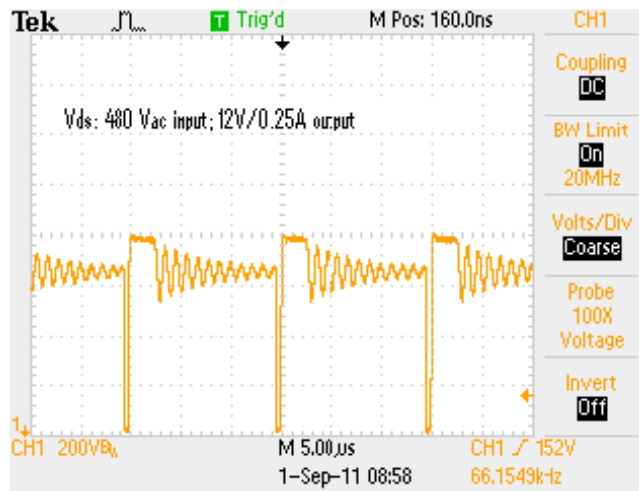

Figure 7. Q1 MOSFET Drain to Source Voltage Profile at 480 Vac Input (25% Rated Load)

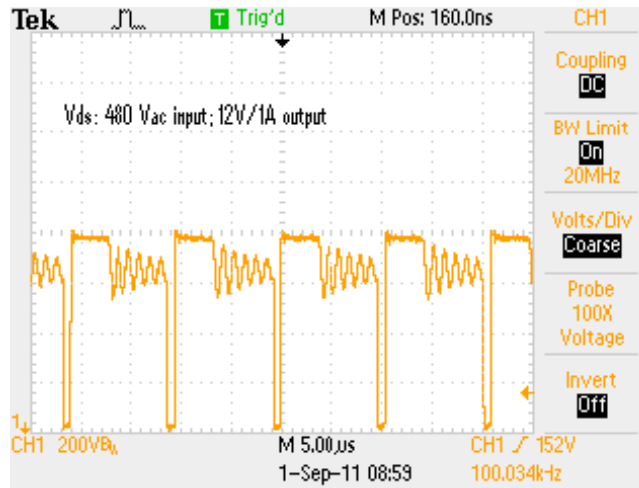

Figure 8. Q1 MOSFET Drain to Source Voltage Profile at 480 Vac Input (Full Load)

DN05017/D

BILL OF MATERIALS

Table 2. BILL OF MATERIALS FOR 10 W, NCP1251 ULTRA-WIDE INPUT FLYBACK

Designator	Qty	Description	Value	Tolerance	Footprint	Manufacturer	Manufacturer Part Number	Substitution Allowed
D8 (12 Vout)	1	Schottky Diode	3 A, 100 V		SMC	ON Semiconductor	MBRS3100T3G	No
D8 (5 Vout)	1	Schottky Diode	3 A, 60 V		SMC	ON Semiconductor	MBRS360T3G	No
Q1	1	MOSFET – 2SK4177	1 A, 1.5 kV		DPAK	Sanyo/ ON Semiconductor	2SK4177	No
D1, D2, D3, D4, D6	5	Diode – 60 Hz	1 A, 1 kV		SMA	ON Semiconductor	MRA4007	No
D5A, D5B	2	Diode – Fast Recov.	1 A, 600 V		Axial Lead	ON Semiconductor	1N4937	No
D7	1	Signal Diode	100 mA, 100 V		SOD-123	ON Semiconductor	MMSD4148A	No
U3	1	Programmable Zener	2.5 V		SOIC8/ SOT23	ON Semiconductor	NCP431A	No
U2	1	Optocoupler	CTR >= 0.5		4-pin	Vishay or NEC	SFH6156A-4 or PS2561L-1	Yes
U1	1	Controller – NCP1251B			TSOP-6	ON Semiconductor	NCP1251B	No
C1, C2	2	“X2” Cap, Box Type	100 nF, 5200 Vac		7 x 16 x 26.5 mm; LS = 22.5 mm	Kemet	474N31000001M	Yes
C13	1	Y1 Cap – Ceramic Disc	1 nF, 3 kV		LS = 7.5 mm	Rifa, Wima		Yes
C5	1	Ceramic Cap, Disc	2.2 nF, 2 kV	5%	LS = 7.5 mm	Rifa, Wima	TBD	Yes
C6	1	Ceramic Cap, Disc	1 nF, 50 V	10%	1206	AVX, Murata	TBD	Yes
C11, C12	2	Ceramic Cap, Disc	100 nF, 50 V	10%	1206	AVX, Murata	TBD	Yes
C7, C8	2	Ceramic Cap, Disc	100 pF, 50 V	5%	1206	AVX, Murata	TBD	Yes
C3, C4	2	Electrolytic Cap	47 μF, 400 V	10%	LS = 7.5 mm, D = 16 mm	UCC, Panasonic	TBD	Yes
C9	1	Electrolytic Cap	4.7 μF, 50 Vdc	10%	LS = 2.5 mm, D = 6.3 mm	UCC, Panasonic	TBD	Yes
C10A, C10B	2	Electrolytic Cap	1000 μF, 16 V	10%	LS = 5 mm, D = 12.5 mm	UCC, Panasonic	TBD	Yes
(5 Vout)	2	Electrolytic Cap	3300 μF, 6.3 V	10%	LS = 5 mm, D = 12.5 mm	UCC, Panasonic	TBD	Yes
R1	1	Resistor, 5 W, Wire Wound	6.8 Ω, 5 W	10%	LS = 7.5 mm, D = 7 mm	Ohmite, Dale	TBD	Yes
R2	1	Resistor, 1 W, Metal Film	47 kΩ, 1 W	10%	Axial Lead; LS = 25 mm	Ohmite, Dale	TBD	Yes
R10	1	Resistor, 1/2 W Metal Film	1.2 Ω, 1/2 W	10%	Axial Lead; LS = 12.5 mm	Ohmite, Dale	TBD	Yes
R6, R8, R15, R16	4	Resistor, 1/4 W SMD	1 kΩ	1%	SMD 1206	AVX, Vishay, Dale	TBD	Yes
R4A, R4B, R4C, R4D	4	Resistor, 1/4 W SMD	390 kΩ	5%	SMD 1206	AVX, Vishay, Dale	TBD	Yes
R3A/B, R5A/B	4	Resistor, 1/4 W SMD	1 MΩ	5%	SMD 1206	AVX, Vishay, Dale	TBD	Yes
R11	1	Resistor, 1/4 W SMD	TBD	1%	SMD 1206	AVX, Vishay, Dale	TBD	Yes
R7	1	Resistor, 1/4 W SMD	0 Ω	1%	SMD 1206	AVX, Vishay, Dale	TBD	Yes
R9, R13, R14	3	Resistor, 1/4 W SMD	10 kΩ	1%	SMD 1206	AVX, Vishay, Dale	TBD	Yes
R12 (12 Vout)	1	Resistor, 1/4 W SMD	39 kΩ	5%	SMD 1206	AVX, Vishay, Dale	TBD	Yes
R12 (5 Vout)	1	Resistor, 1/4 W SMD	10 kΩ	1%	SMD 1206	AVX, Vishay, Dale	TBD	Yes
R17, R18	2	Resistor, 1/4 W SMD	5.6 kΩ	5%	SMD 1206	AVX, Vishay, Dale	TBD	Yes
F1	1	Fuse, TR-5 Style	2 A		TR-5, LS = 5 mm	Minifuse		Yes
L1A/B	2	Inductor (EMI Choke)	820 μH, 500 mA		Dia = 10mm, LS = 5mm	Coilcraft	RFB0810-1821L	Yes

DN05017/D

Table 2. BILL OF MATERIALS FOR 10 W, NCP1251 ULTRA-WIDE INPUT FLYBACK (continued)

Designator	Qty	Description	Value	Tolerance	Footprint	Manufacturer	Manufacturer Part Number	Substitution Allowed
T1 (12 Vout)	1	Transformer	E20/10/6 Core		See Mag Drawing	Würth Magnetics	750312495	Yes
T1 (5 Vout)	1	Transformer	E20/10/6 Core		See Mag Drawing	Würth Magnetics	750312279	Yes
J1, J2	2	Screw Terminal			LS = 0.2"	DigiKey	# 281-1435-ND	Yes

NOTE: Grey indicates part change with Vout change

REFERENCES

- [1] ON Semiconductor Data Sheet for [NCP1251/D](#) Controller in TSOP6 Package.
- [2] ON Semiconductor Design Notes [DN05012/D](#), [DN05014/D](#).
- [3] ON Semiconductor Application Note [AND8489/D](#)

ON Semiconductor and the  are registered trademarks of Semiconductor Components Industries, LLC (SCILLC) or its subsidiaries in the United States and/or other countries. SCILLC owns the rights to a number of patents, trademarks, copyrights, trade secrets, and other intellectual property. A listing of SCILLC's product/patent coverage may be accessed at www.onsemi.com/site/pdf/Patent-Marking.pdf. SCILLC reserves the right to make changes without further notice to any products herein. SCILLC makes no warranty, representation or guarantee regarding the suitability of its products for any particular purpose, nor does SCILLC assume any liability arising out of the application or use of any product or circuit, and specifically disclaims any and all liability, including without limitation special, consequential or incidental damages. "Typical" parameters which may be provided in SCILLC data sheets and/or specifications can and do vary in different applications and actual performance may vary over time. All operating parameters, including "Typicals" must be validated for each customer application by customer's technical experts. SCILLC does not convey any license under its patent rights nor the rights of others. SCILLC products are not designed, intended, or authorized for use as components in systems intended for surgical implant into the body, or other applications intended to support or sustain life, or for any other application in which the failure of the SCILLC product could create a situation where personal injury or death may occur. Should Buyer purchase or use SCILLC products for any such unintended or unauthorized application, Buyer shall indemnify and hold SCILLC and its officers, employees, subsidiaries, affiliates, and distributors harmless against all claims, costs, damages, and expenses, and reasonable attorney fees arising out of, directly or indirectly, any claim of personal injury or death associated with such unintended or unauthorized use, even if such claim alleges that SCILLC was negligent regarding the design or manufacture of the part. SCILLC is an Equal Opportunity/Affirmative Action Employer. This literature is subject to all applicable copyright laws and is not for resale in any manner.

PUBLICATION ORDERING INFORMATION

LITERATURE FULFILLMENT:

Literature Distribution Center for ON Semiconductor
P.O. Box 5163, Denver, Colorado 80217 USA
Phone: 303-675-2175 or 800-344-3860 Toll Free USA/Canada
Fax: 303-675-2176 or 800-344-3867 Toll Free USA/Canada
Email: orderlit@onsemi.com

N. American Technical Support: 800-282-9855 Toll Free
USA/Canada
Europe, Middle East and Africa Technical Support:
Phone: 421 33 790 2910
Japan Customer Focus Center
Phone: 81-3-5817-1050

ON Semiconductor Website: www.onsemi.com

Order Literature: <http://www.onsemi.com/orderlit>

For additional information, please contact your local Sales Representative